



TAOGLAS®



Datasheet

Synergy 4 in 1 Antenna

Part No:
MA1504.AK.001

Description:

4*5G/4G MIMO 4-in-1 Antenna with Wideband 600-6000MHz Capabilities

Features:

4 x 5G/4G MIMO Antenna
IP67 Rated Waterproof Enclosure
High Efficiency/Peak Gain Outdoor Antenna
Cable: 300mm RG-174 with 4700mm TGC-200
Connectors: SMA(M)
RoHS & REACH Compliant

1. Introduction	3
2. Specifications	4
3. Antenna Characteristics	7
4. Radiation Patterns	10
5. Mechanical Drawing	55
6. Packaging	56
Changelog	57

Taoglas makes no warranties based on the accuracy or completeness of the contents of this document and reserves the right to make changes to specifications and product descriptions at any time without notice. Taoglas reserves all rights to this document and the information contained herein. Reproduction, use or disclosure to third parties without express permission is strictly prohibited.



1. Introduction



The Taoglas Synergy MA1504 is a 4-in-1 next-generation permanent mount antenna for vehicle roof applications. It has a fully IP67 rated waterproof robust PC enclosure and base. The 4 antennas inside support 600-6000MHz 5G/4G. This outstanding patent-pending antenna delivers powerful MIMO antenna technology for 5G/4G. The 5G/4G antennas also include backward compatibility to work at most worldwide 2G and 3G bands.

Typical Applications:

- Next Generation OEM Automotive Connectivity
- Multimedia, Navigation and Telematics Systems
- V2V, V2X and Fleet Management Applications
- Real-time HD Video Streaming
- First Net Responder Routers

The MA1504 is ideal for applications that require highly sophisticated antennas for real-time streaming applications that demand high-speed video uplink and downlink into the cabin of the vehicle. These challenges are resolved by the highly efficient, high gain MIMO antennas, with high isolation, all of which is necessary to achieve the required signal to noise ratio and throughput.

The MA1504 can also be customized for your particular wireless application and frequency band, subject to NRE and MOQ. All cable lengths and connector types are customizable. The Synergy MA1504 can be supplied with low loss TGC-200 cable extensions for longer cable runs. Contact your regional Taoglas customer services team for details and support.

2. Specifications

5G/4G MIMO									
Band	Frequency (MHz)		Efficiency (%)	Average Gain (dB)	Peak Gain (dBi)	Impedance	Polarization	Radiation Pattern	Max. input power
5G NR Band 71	617 ~698	LTE 1	16%	-8.0	-2.7	50 Ω	Linear	Omni	2W
		LTE 2	16%	-8.1	-4.0				
		LTE 3	15%	-8.1	-3.8				
		LTE 4	17%	-7.8	-3.6				
LTE700	698 ~824	LTE 1	18%	-7.5	-2.0				
		LTE 2	18%	-7.6	-1.6				
		LTE 3	15%	-8.2	-3.5				
		LTE 4	18%	-7.4	-2.3				
GSM 850/900	824 ~960	LTE 1	22%	-6.6	-0.1				
		LTE 2	27%	-5.7	1.2				
		LTE 3	22%	-6.7	-0.6				
		LTE 4	28%	-5.6	1.8				
5G NR Band	1427 ~1518	LTE 1	25%	-6.1	1.5				
		LTE 2	24%	-6.2	2.1				
		LTE 3	28%	-5.6	2.3				
		LTE 4	22%	-6.7	1.1				
DCS	1710 ~1880	LTE 1	33%	-4.8	2.7				
		LTE 2	30%	-5.2	2.4				
		LTE 3	31%	-5.0	2.3				
		LTE 4	29%	-5.3	2.6				
PCS	1850 ~1990	LTE 1	32%	-4.9	2.5				
		LTE 2	30%	-5.3	2.9				
		LTE 3	31%	-5.1	1.7				
		LTE 4	28%	-5.5	2.9				
UMTS1	1920 ~2170	LTE 1	34%	-4.7	3.3				
		LTE 2	26%	-5.8	1.6				
		LTE 3	32%	-5.0	2.7				
		LTE 4	26%	-5.9	2.1				
LTE2600	2300 ~2690	LTE 1	33%	-4.9	4.5				
		LTE 2	24%	-6.2	1.5				
		LTE 3	32%	-5.0	4.1				
		LTE 4	25%	-6.0	1.8				
5G NR Band 48, 77, 78, 79	3300 ~5000	LTE 1	21%	-7.0	1.3				
		LTE 2	20%	-7.2	1.0				
		LTE 3	21%	-6.9	1.6				
		LTE 4	15%	-8.3	-0.2				
LTE5200/ Wi-Fi 5800	5150 ~5925	LTE 1	24%	-6.2	2.3				
		LTE 2	23%	-6.5	2.0				
		LTE 3	24%	-6.1	2.3				
		LTE 4	23%	-6.4	2.4				

Mechanical	
Height	57.47mm
Planner Dimension	Ø160mm
Casing	PC
Cable	0.3m RG-174 with 4.7m TGC-200 for 5G/4G – Fully Customizable
Connector	5G/4G_SMA-Plug – Fully Customizable
Thread	18.23mm
Thread Diameter	M22
Waterproof	IP67
Sealant	Rubber Stopper and O-Ring
Weight	2Kg
Environmental	
Ingress Protection	IP67
Temperature Range	-40°C to 85°C
Humidity	Non-condensing 65°C 95% RH
Cable Pull	RG-174 4 Kg

5G/4G Bands			
Band Number	5GNR / FR1 / LTE / LTE-Advanced / WCDMA / HSPA / HSPA+ / TD-SCDMA		
	Uplink	Downlink	Covered
1	UL: 1920 to 1980	DL: 2110 to 2170	✓
2	UL: 1850 to 1910	DL: 1930 to 1990	✓
3	UL: 1710 to 1785	DL: 1805 to 1880	✓
4	UL: 1710 to 1755	DL: 2110 to 2155	✓
5	UL: 824 to 849	DL: 869 to 894	✓
7	UL: 2500 to 2570	DL: 2620 to 2690	✓
8	UL: 880 to 915	DL: 925 to 960	✓
9	UL: 1749.9 to 1784.9	DL: 1844.9 to 1879.9	✓
11	UL: 1427.9 to 1447.9	DL: 1475.9 to 1495.9	✓
12	UL: 699 to 716	DL: 729 to 746	✓
13	UL: 777 to 787	DL: 746 to 756	✓
14	UL: 788 to 798	DL: 758 to 768	✓
17	UL: 704 to 716	DL: 734 to 746 (LTE only)	✓
18	UL: 815 to 830	DL: 860 to 875 (LTE only)	✓
19	UL: 830 to 845	DL: 875 to 890	✓
20	UL: 832 to 862	DL: 791 to 821	✓
21	UL: 1447.9 to 1462.9	DL: 1495.9 to 1510.9	✓
22	UL: 3410 to 3490	DL: 3510 to 3590	✓
23	UL: 2000 to 2020	DL: 2180 to 2200 (LTE only)	✓
24	UL: 1625.5 to 1660.5	DL: 1525 to 1559 (LTE only)	✓
25	UL: 1850 to 1915	DL: 1930 to 1995	✓
26	UL: 814 to 849	DL: 859 to 894	✓
27	UL: 807 to 824	DL: 852 to 869 (LTE only)	✓
28	UL: 703 to 748	DL: 758 to 803 (LTE only)	✓
29	UL: -	DL: 717 to 728 (LTE only)	✓
30	UL: 2305 to 2315	DL: 2350 to 2360 (LTE only)	✓
31	UL: 452.5 to 457.5	DL: 462.5 to 467.5 (LTE only)	✗
32	UL: -	DL: 1452 - 1496	✓
35		1850 to 1910	✓
38		2570 to 2620	✓
39		1880 to 1920	✓
40		2300 to 2400	✓
41		2496 to 2690	✓
42		3400 to 3600	✓
43		3600 to 3800	✓
48		3550 to 3700	✓
66	UL: 1710-1780	DL: 2110-2200	✓
71		617 to 698	✓
74/75/76		1427 to 1518	✓
78		3300 to 3800	✓
79		4400 to 5000	✓

3. Antenna Characteristics

3.1 Return Loss

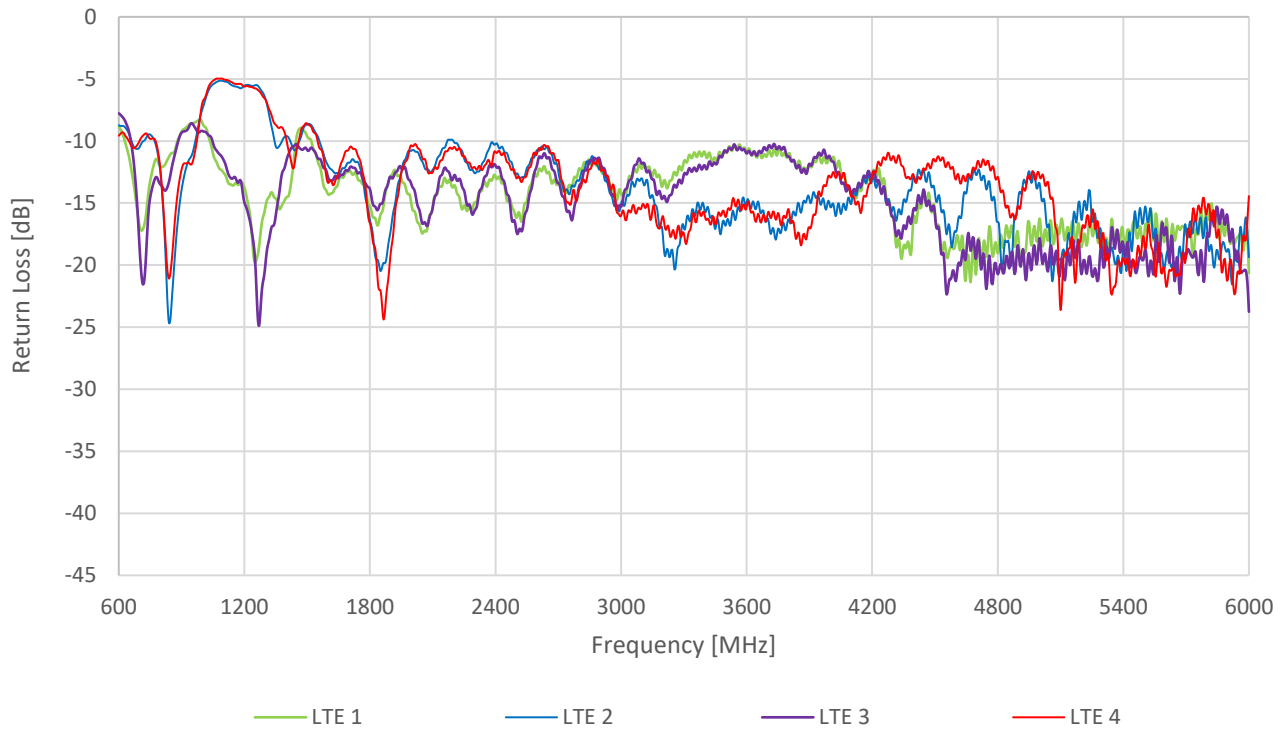

3.2 Isolation

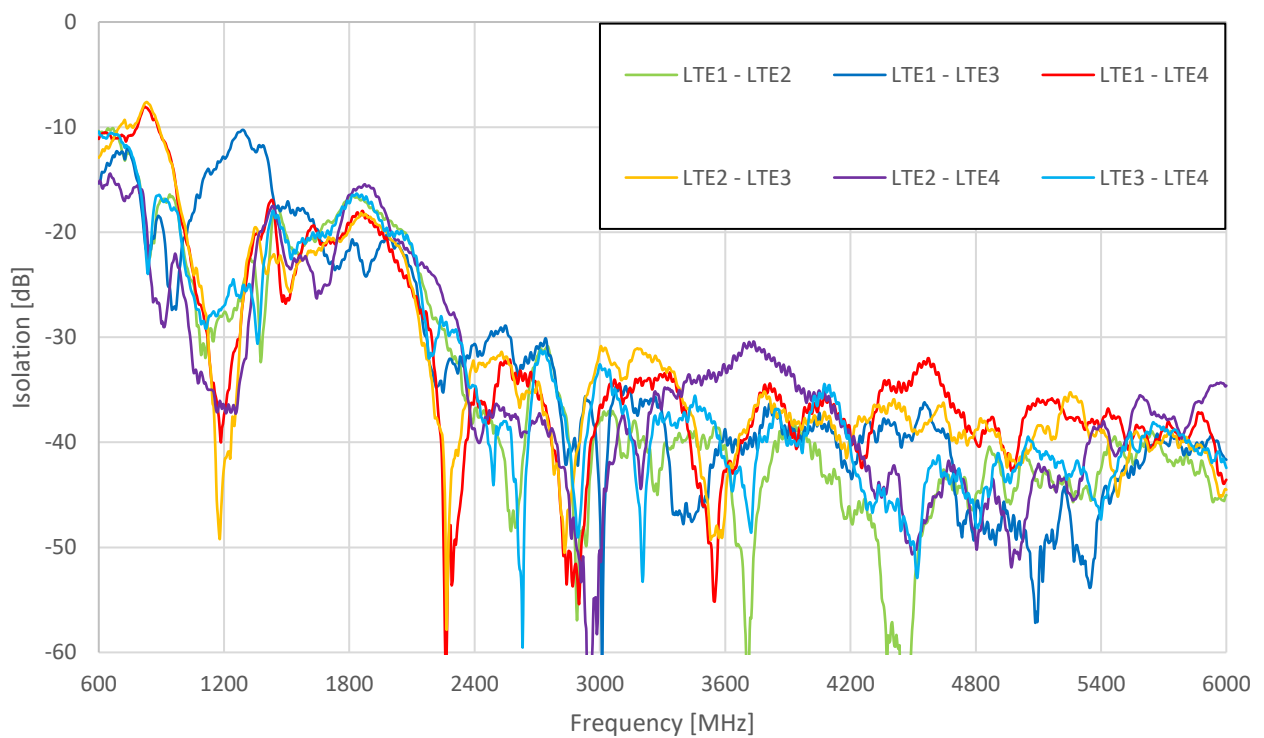

3.3 Efficiency

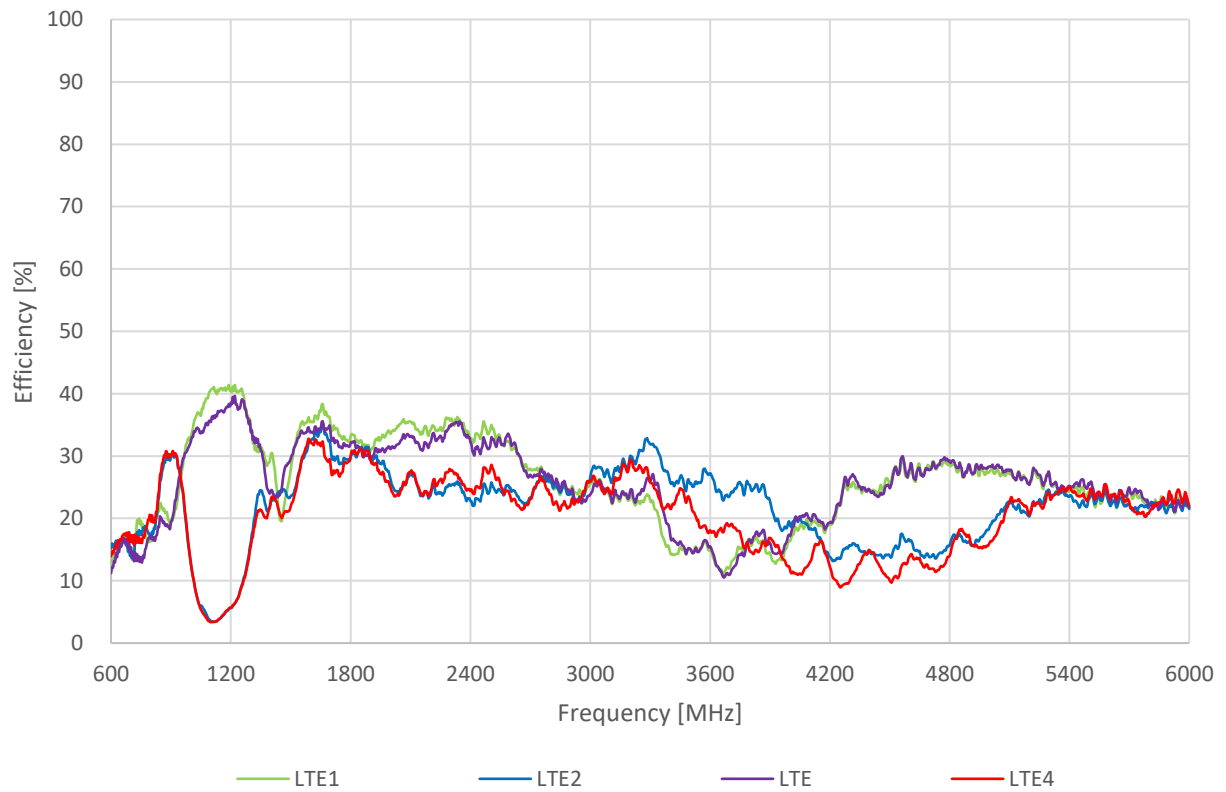

3.4 Average Gain

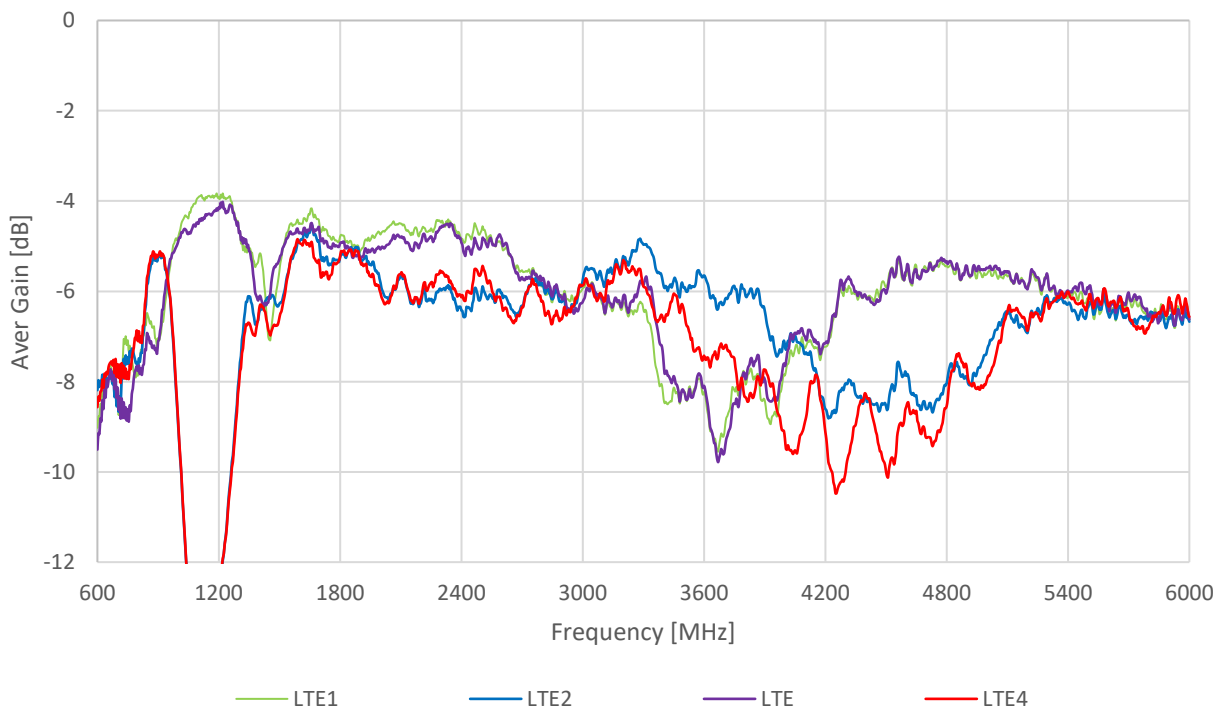

3.5 Peak Gain

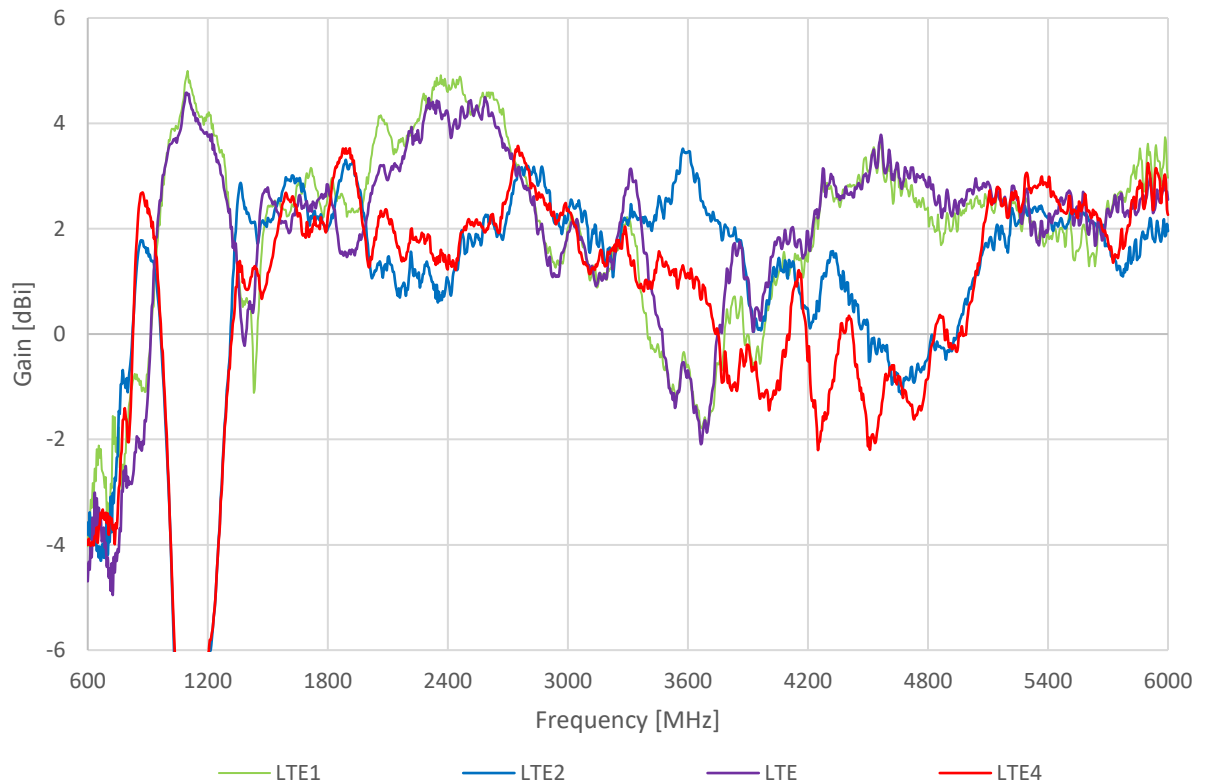

3.6 ECC

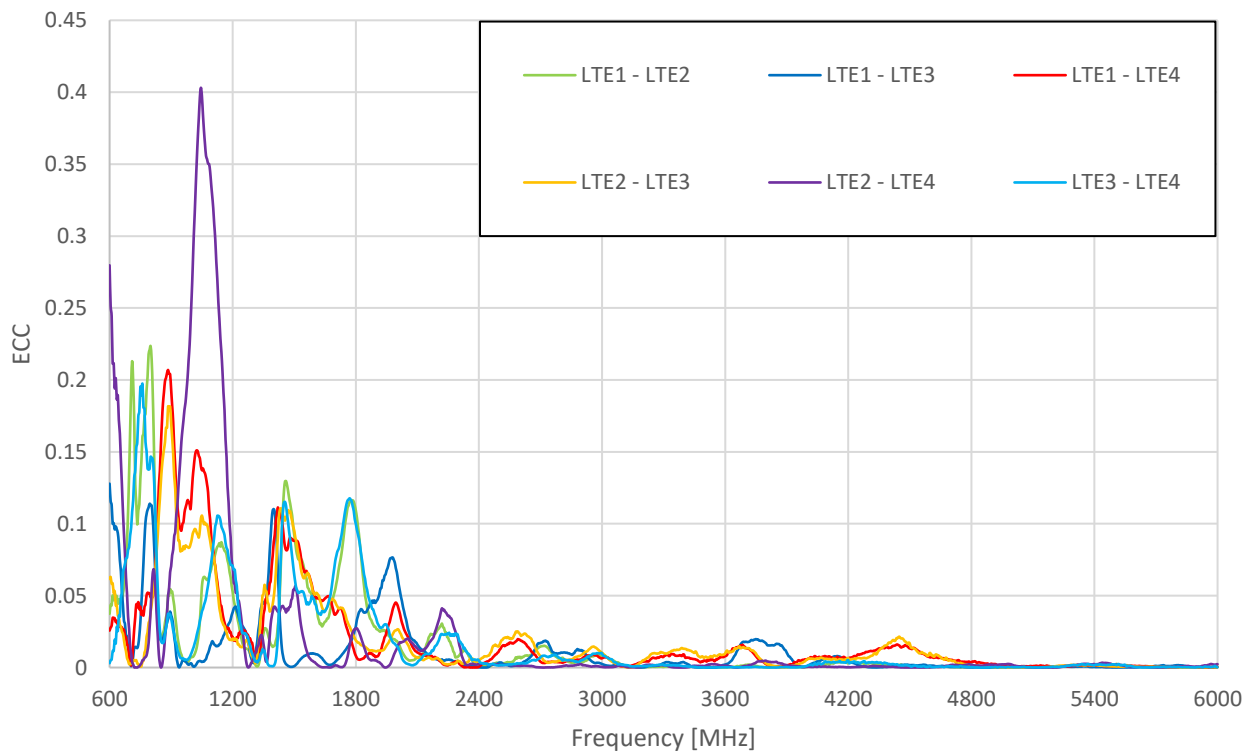

4. Radiation Patterns

4.1 Test Setup

Radiation patterns obtained with 300mm of cable.

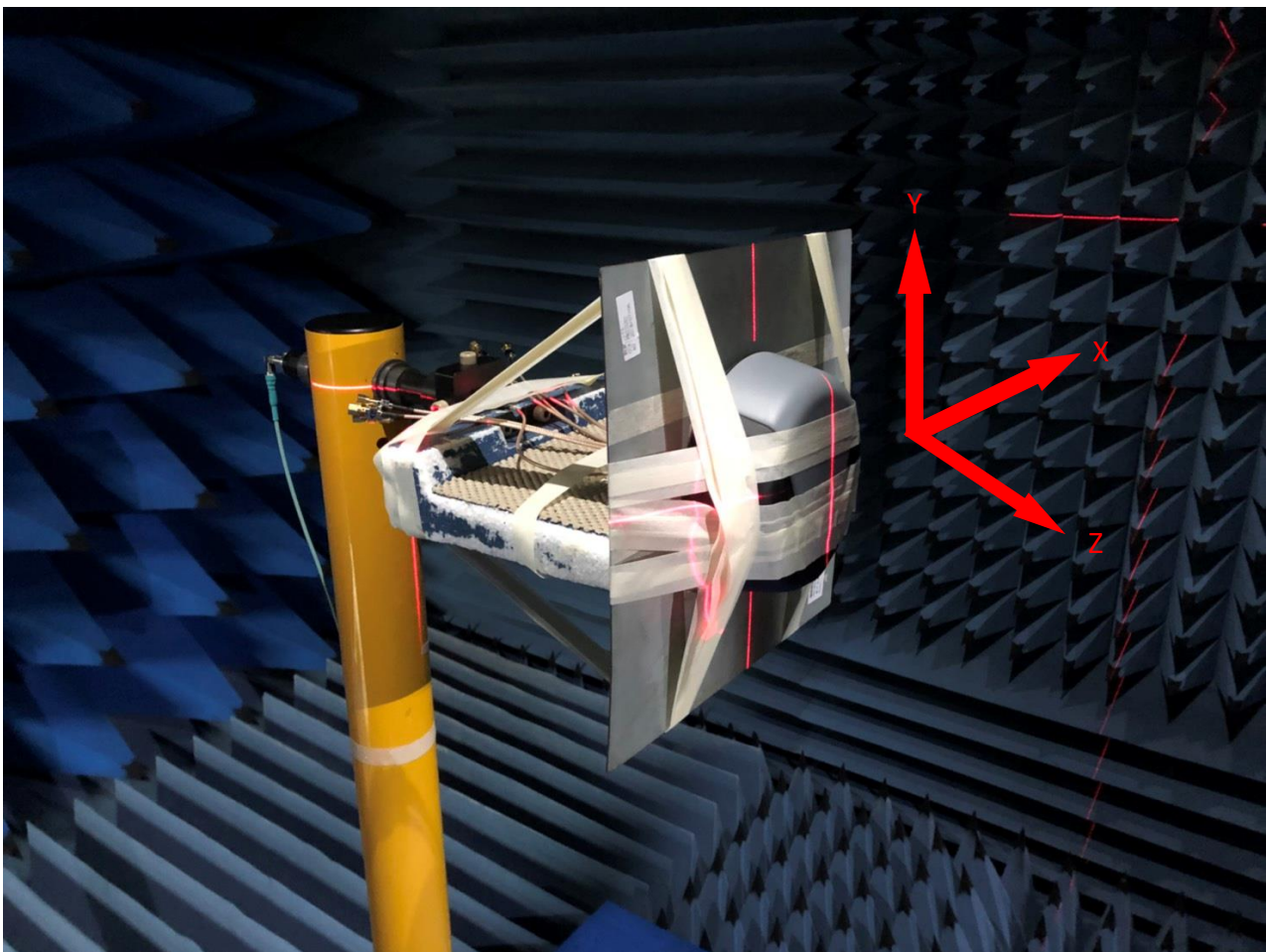

On 30x30cm Ground Plane

4.2 660MHz - MIMO 1 Radiation Patterns

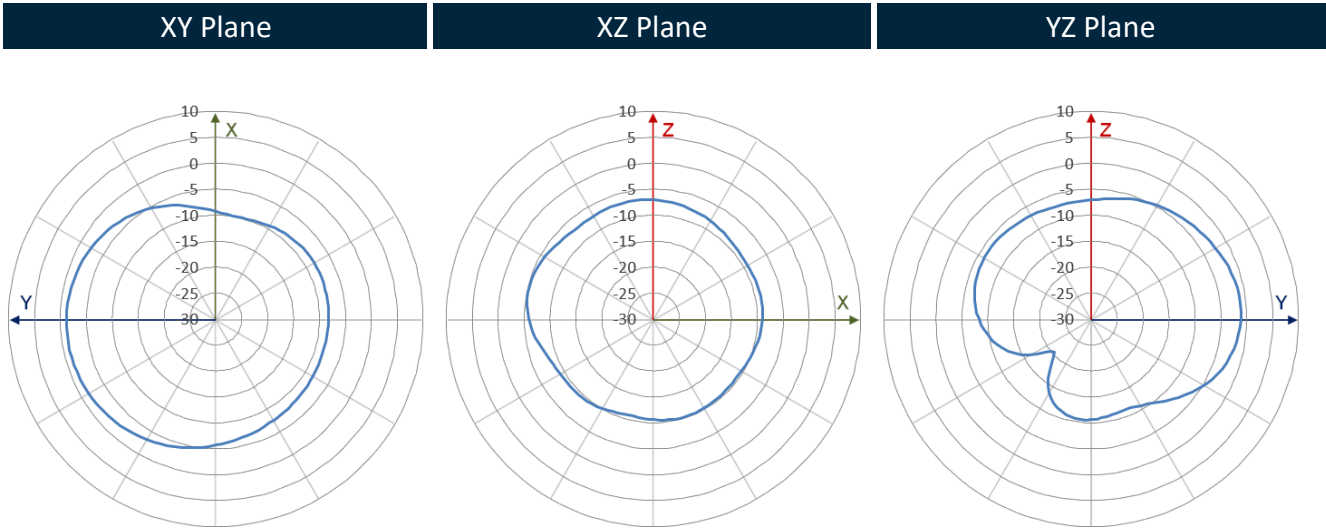
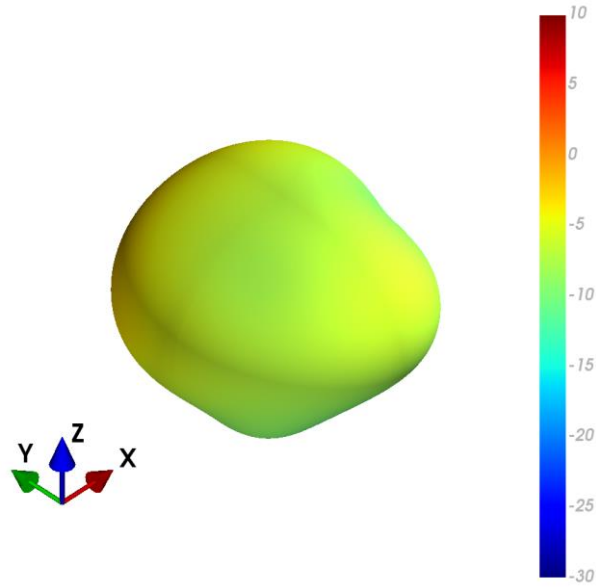

750 MHz

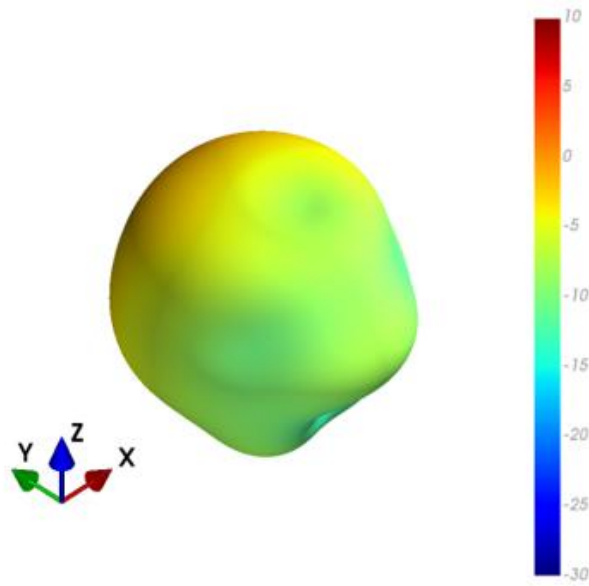

XY Plane

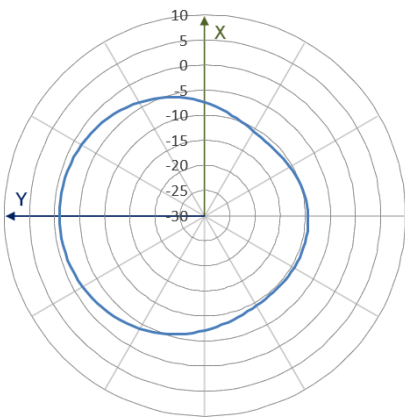

XZ Plane

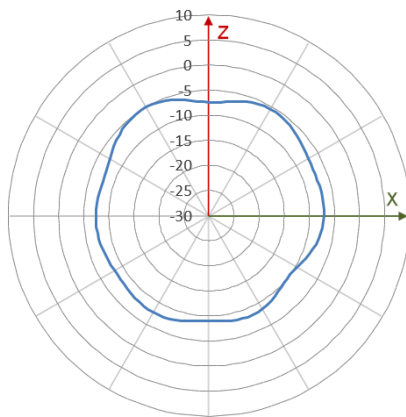

YZ Plane

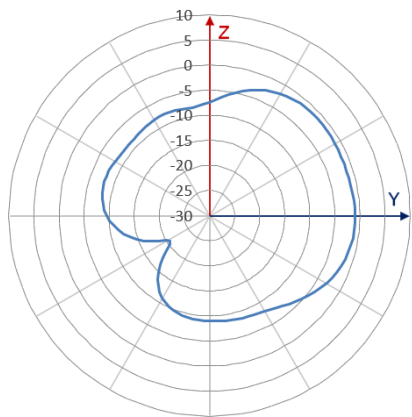

880MHz

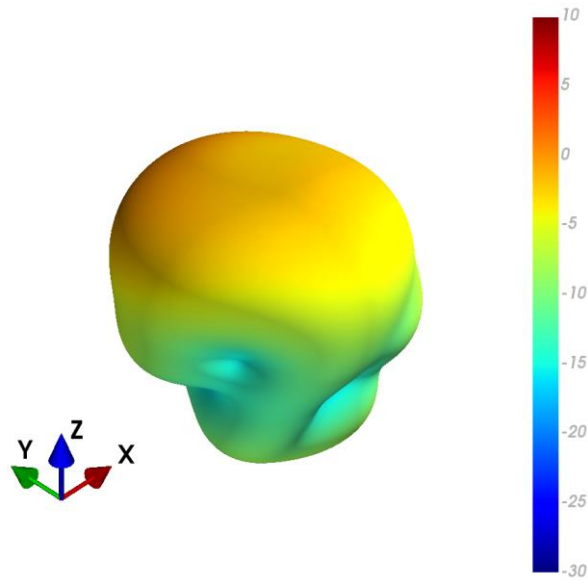

XY Plane

XZ Plane

YZ Plane

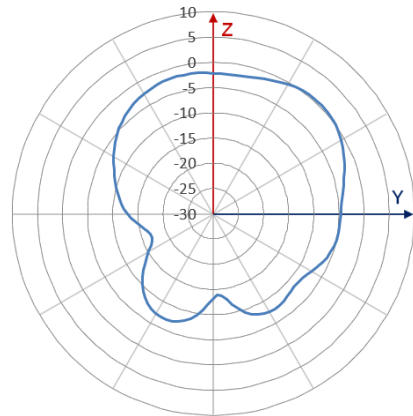
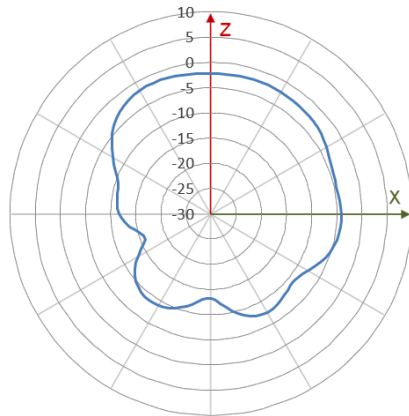
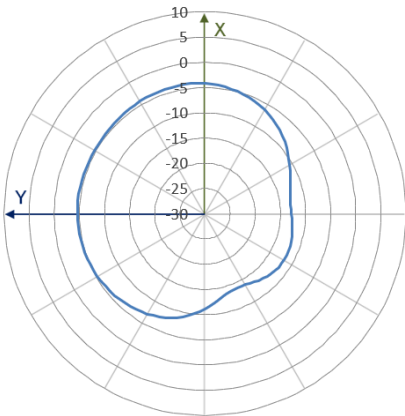

1465MHz

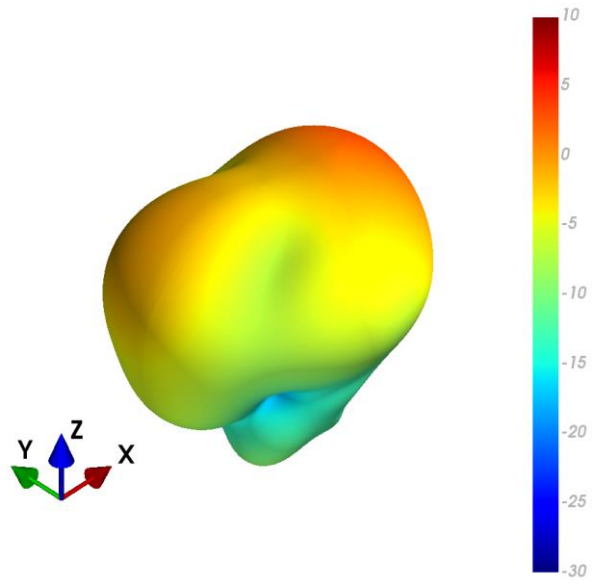

XY Plane

XZ Plane

YZ Plane

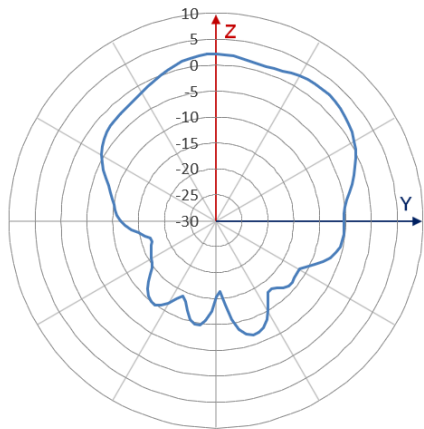
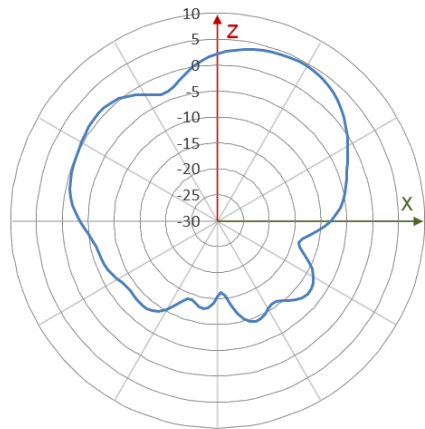
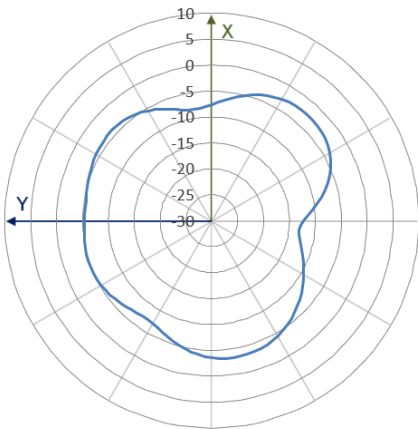

1805MHz

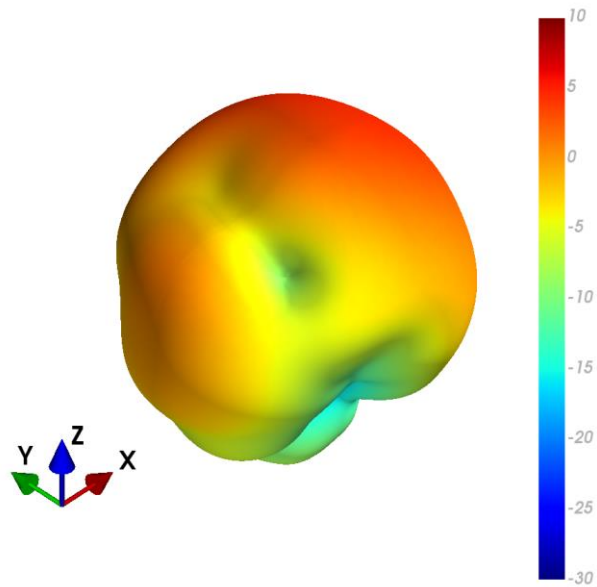

XY Plane

XZ Plane

YZ Plane

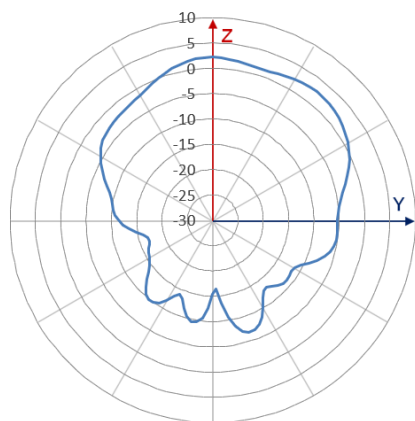
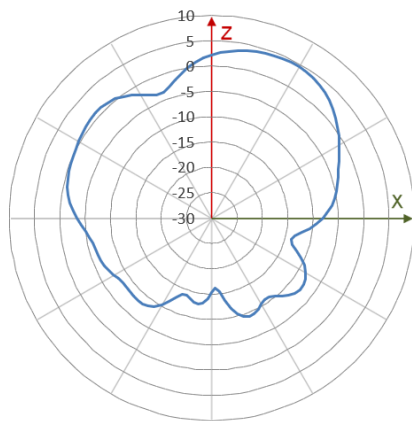
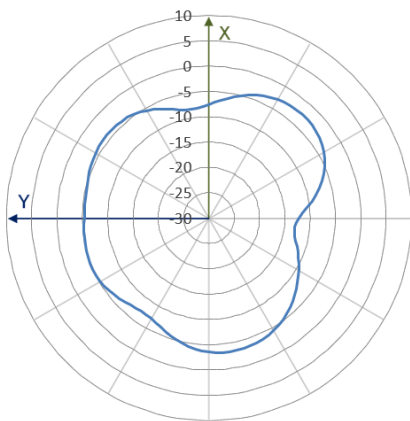

1920MHz

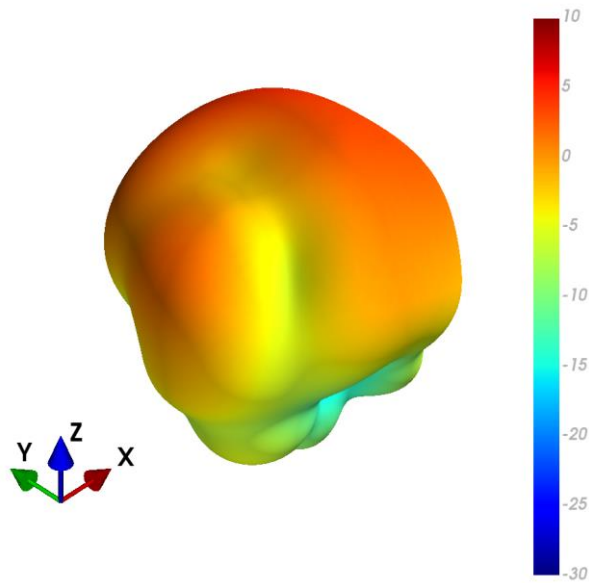

XY Plane

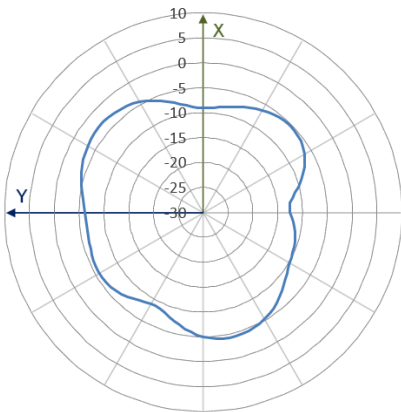

XZ Plane

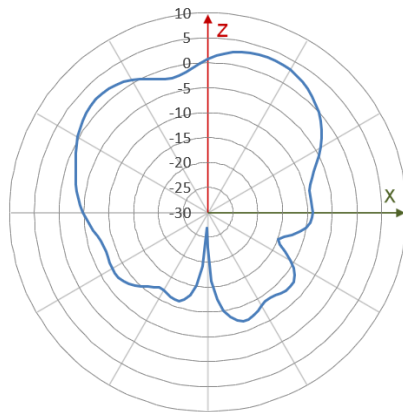

YZ Plane

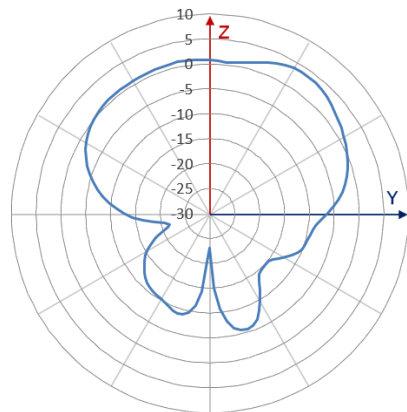

2010MHz

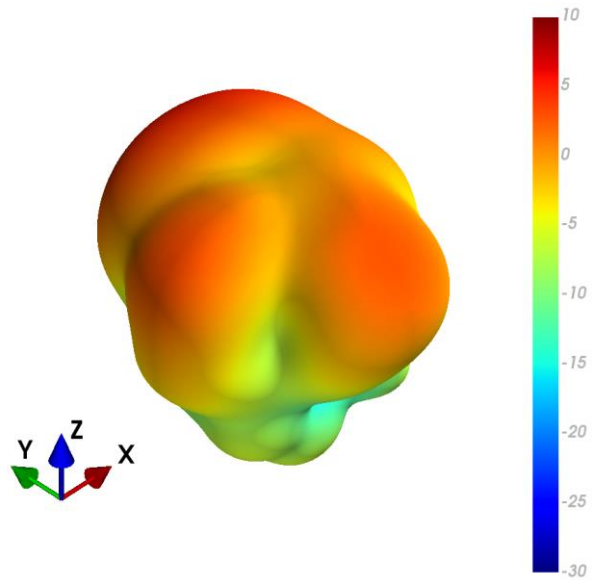

XY Plane

XZ Plane

YZ Plane

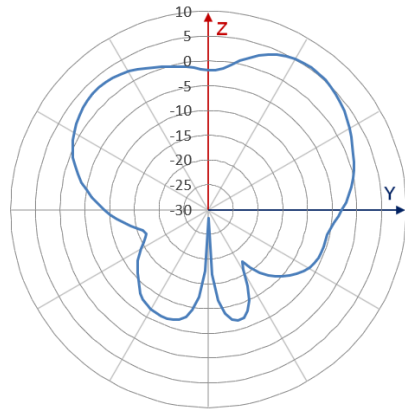
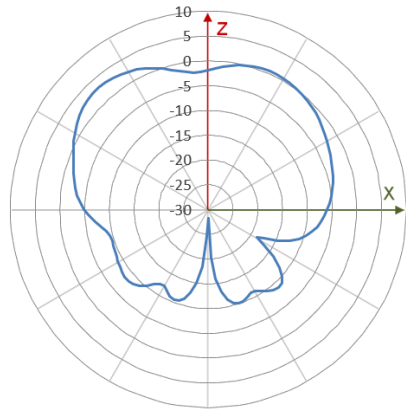
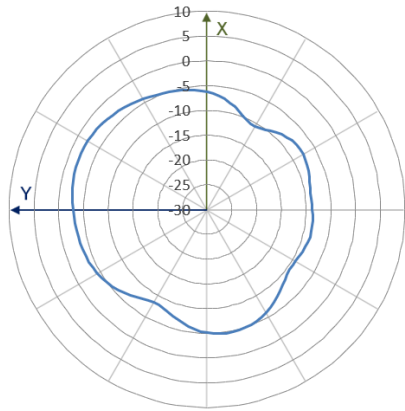

2500MHz

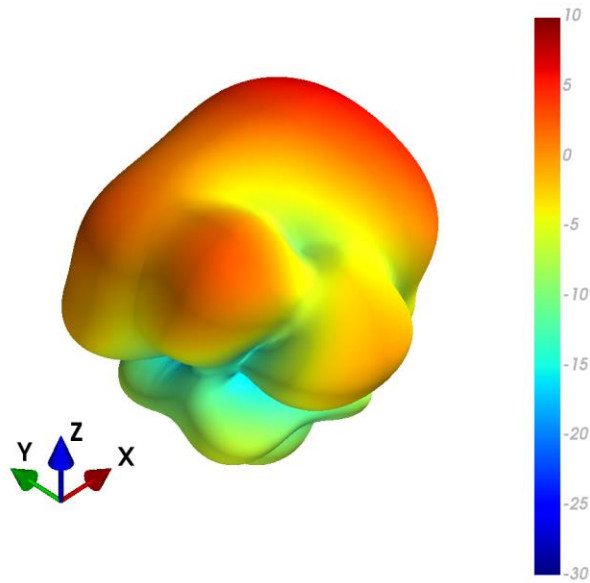

XY Plane

XZ Plane

YZ Plane

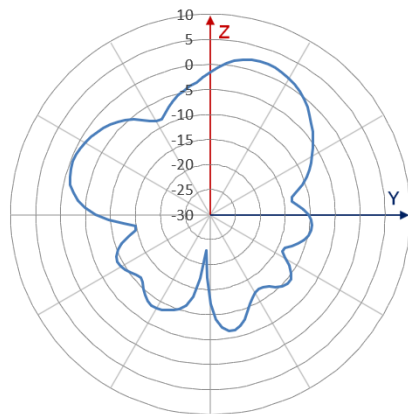
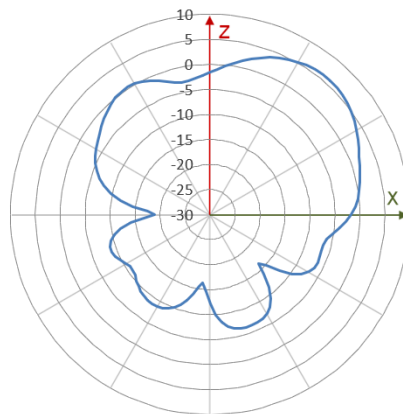
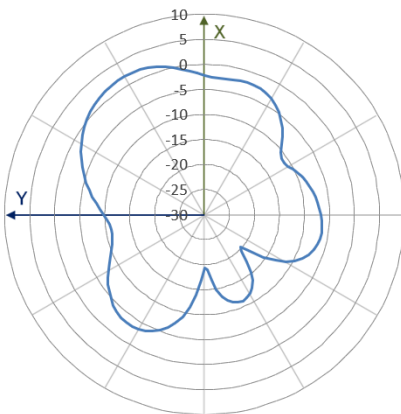

3300MHz

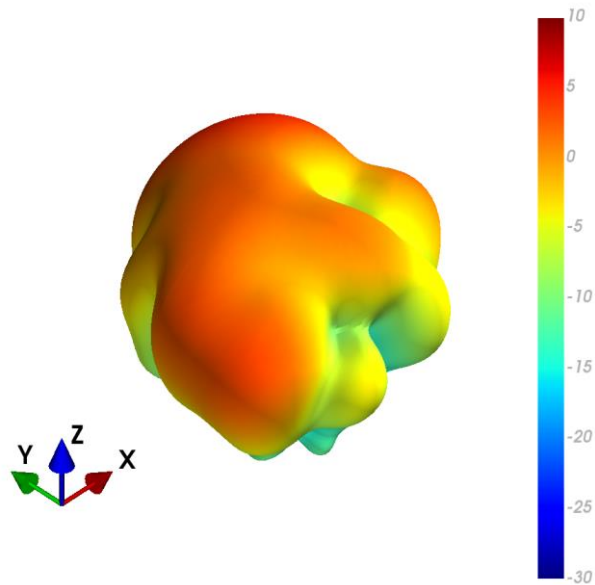

XY Plane

XZ Plane

YZ Plane

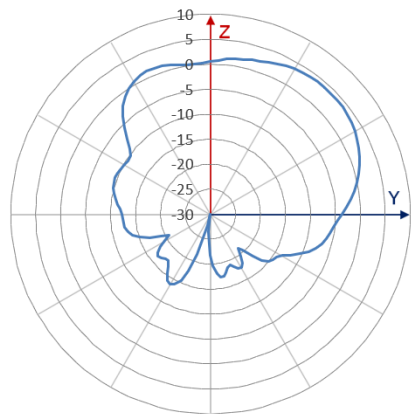
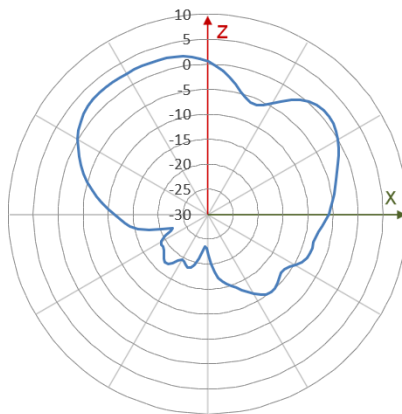
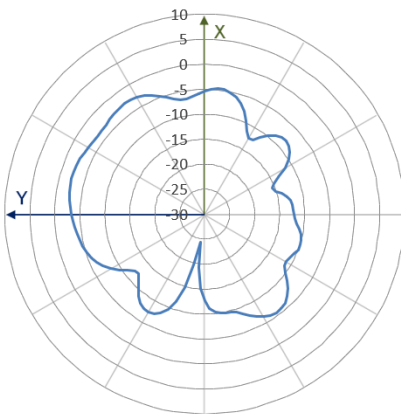

3600MHz

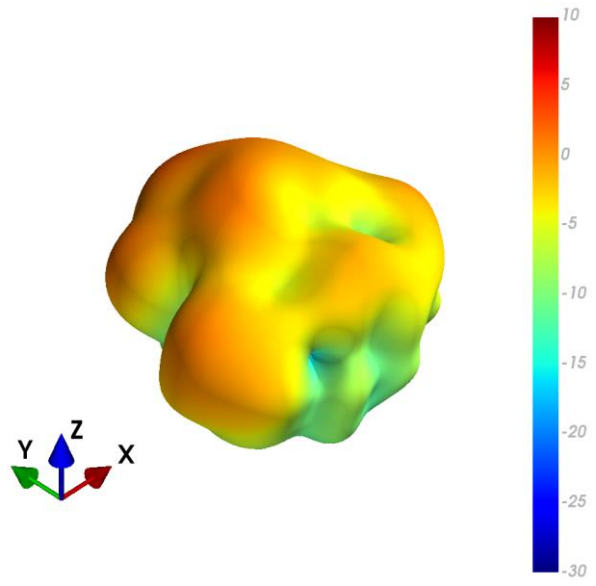

XY Plane

XZ Plane

YZ Plane

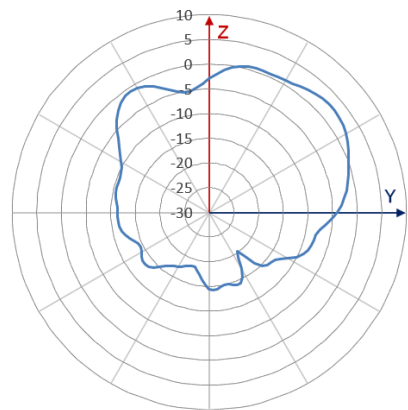
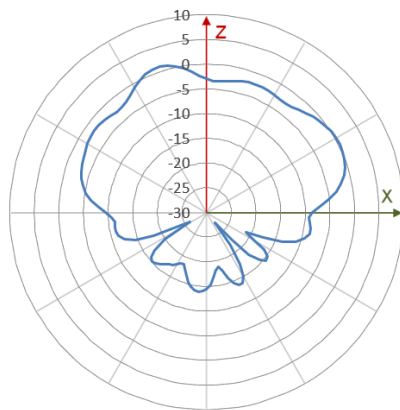
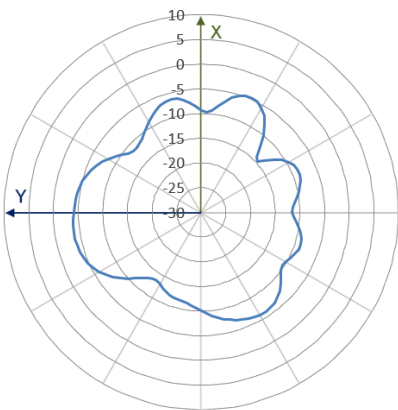

5550MHz

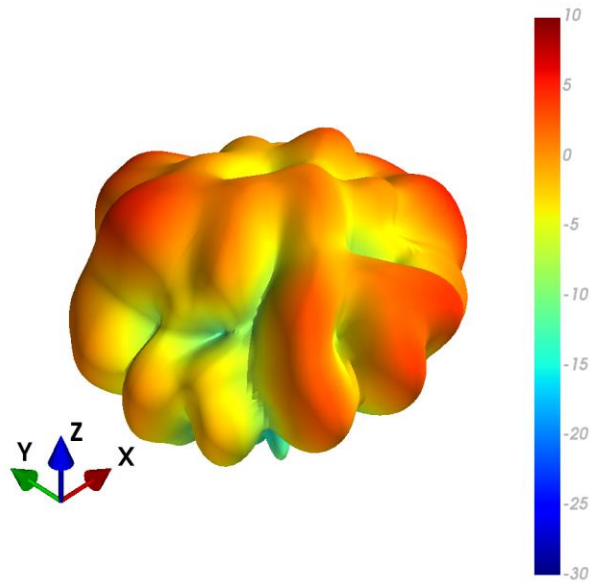

XY Plane

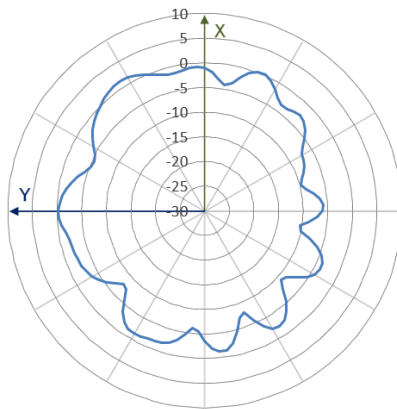

XZ Plane

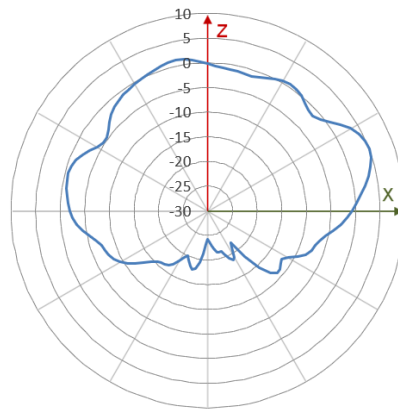

YZ Plane

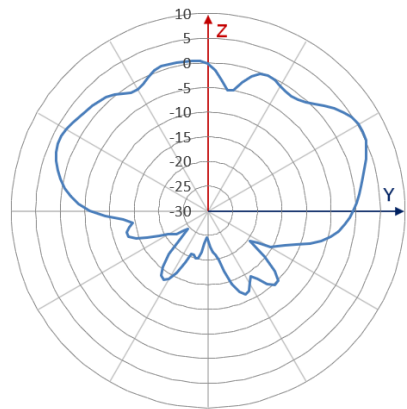

4.3 660MHz - MIMO 2 Radiation Patterns

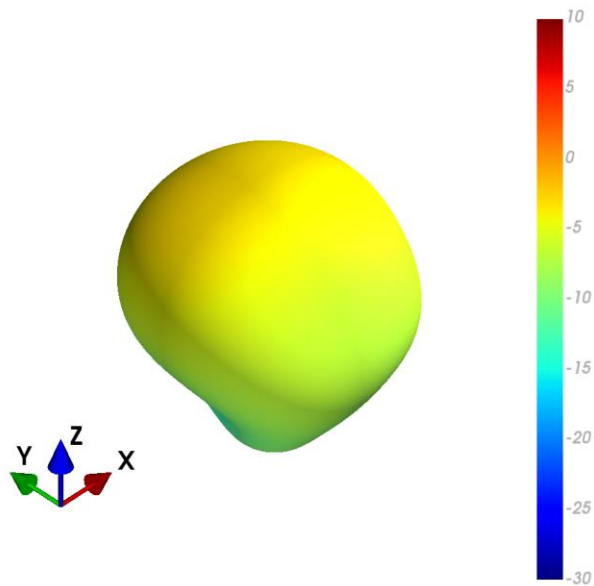

XY Plane XZ Plane YZ Plane

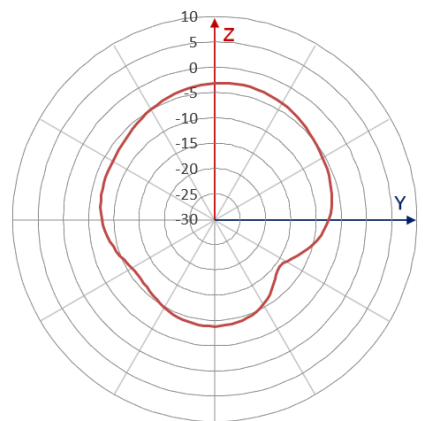
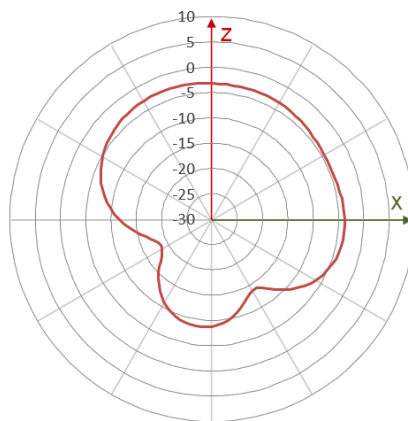
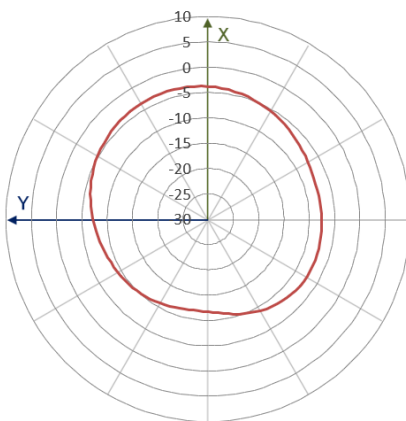

750MHz

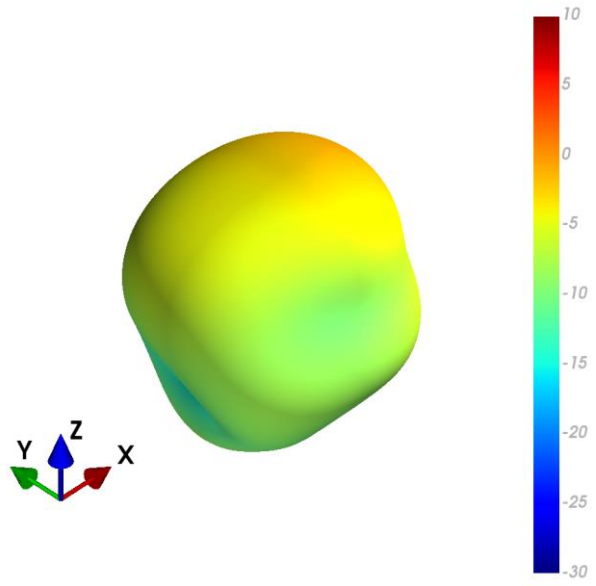

XY Plane

XZ Plane

YZ Plane

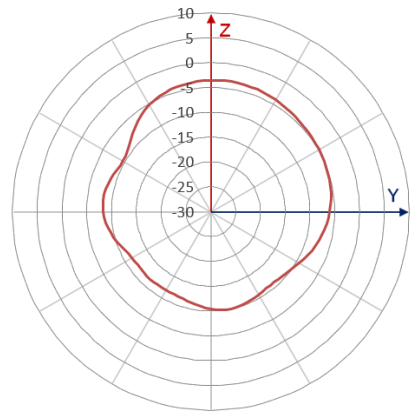
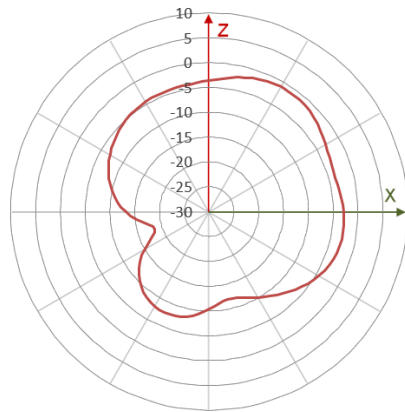
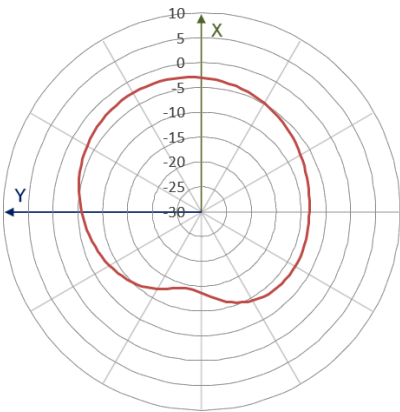

880MHz

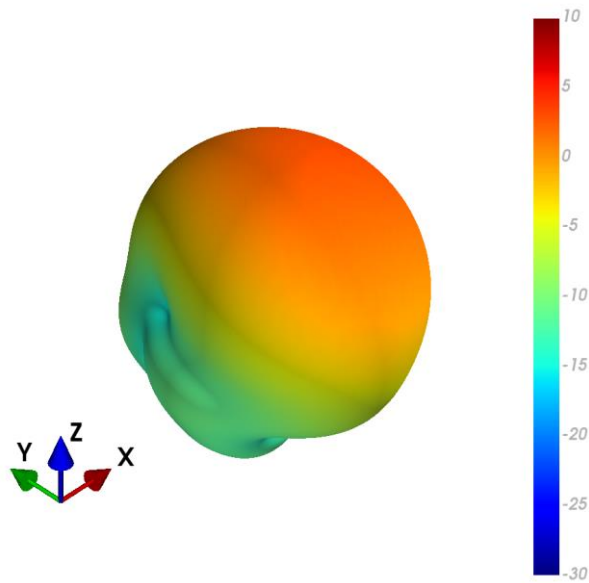

XY Plane

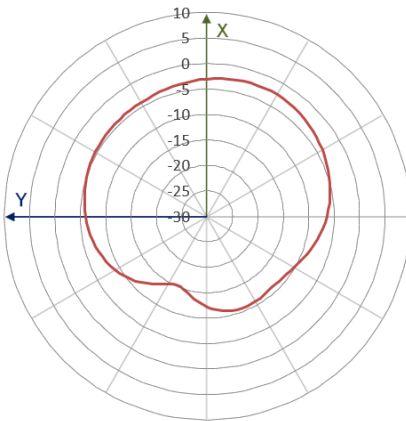

XZ Plane

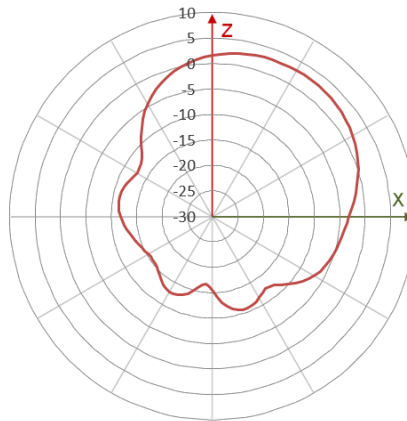

YZ Plane

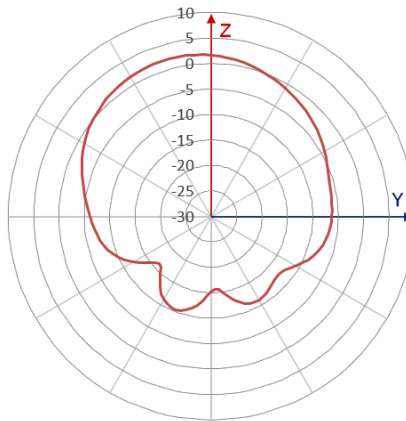

1465MHz

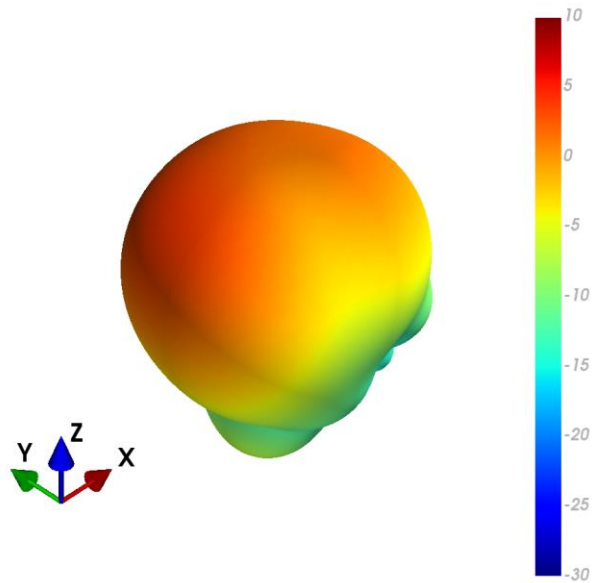

XY Plane

XZ Plane

YZ Plane

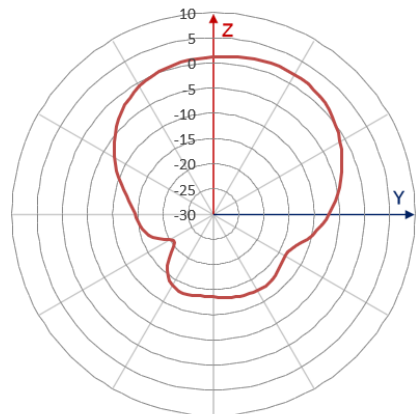
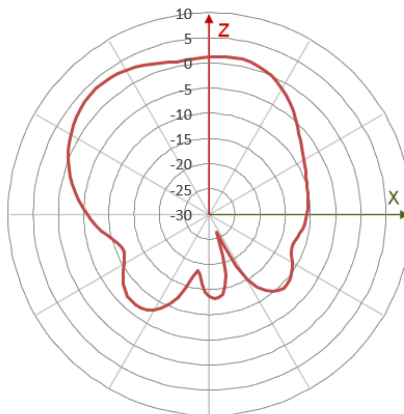
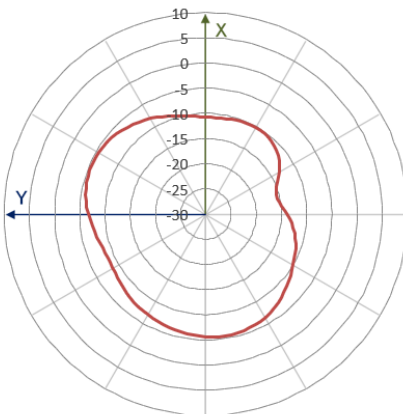

1805MHz

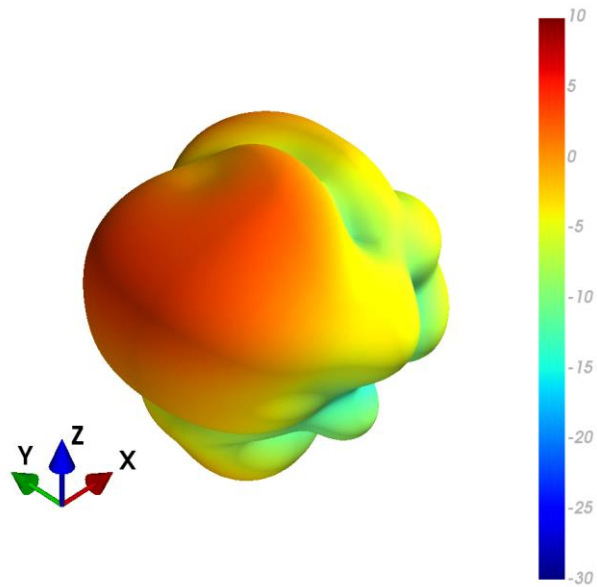

XY Plane

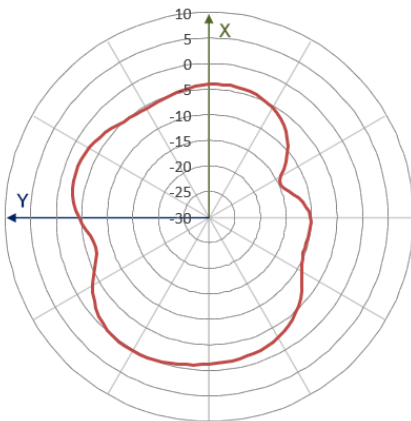

XZ Plane

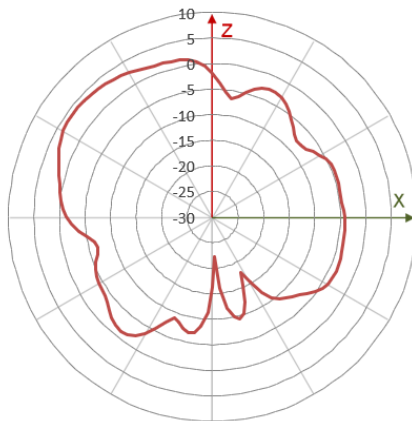

YZ Plane

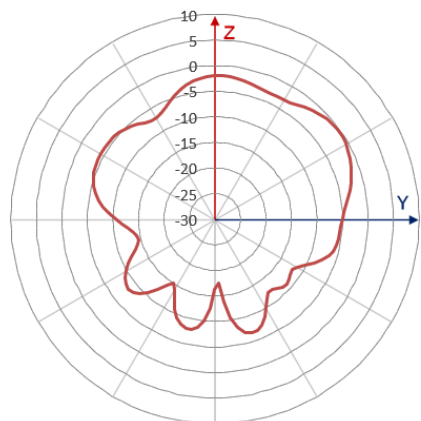

1920MHz

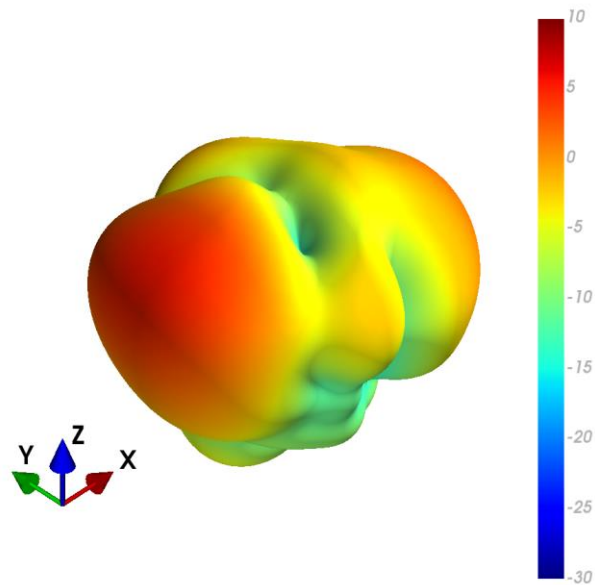

XY Plane

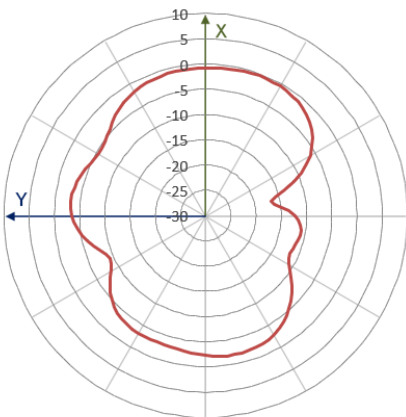

XZ Plane

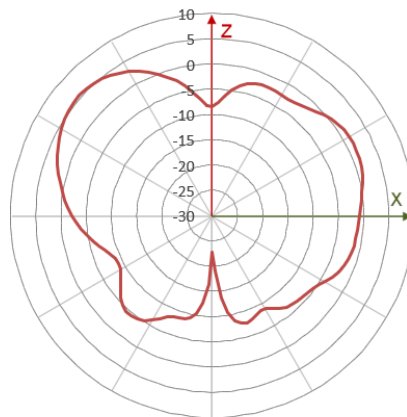

YZ Plane

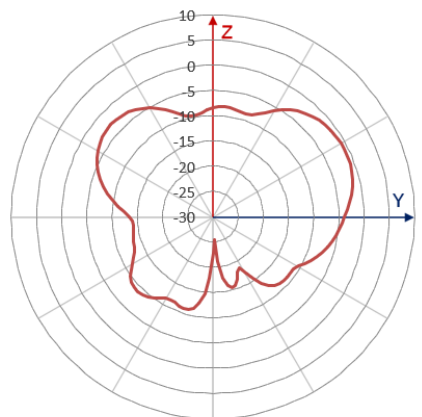

2010MHz

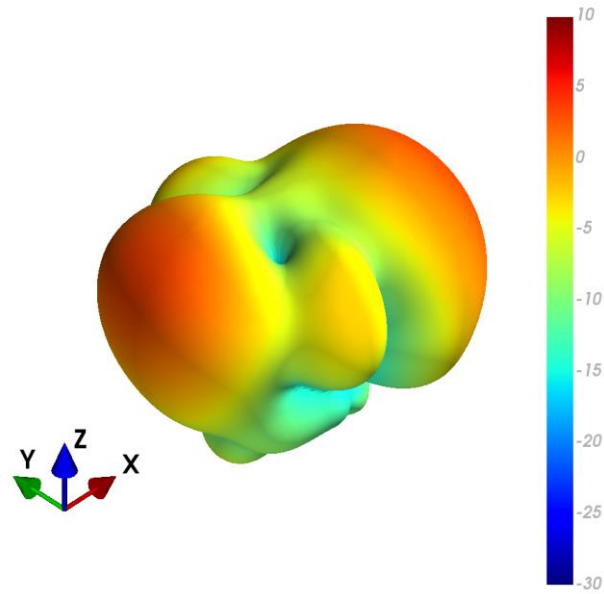

XY Plane

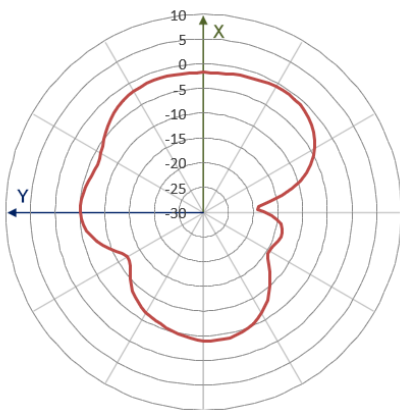

XZ Plane

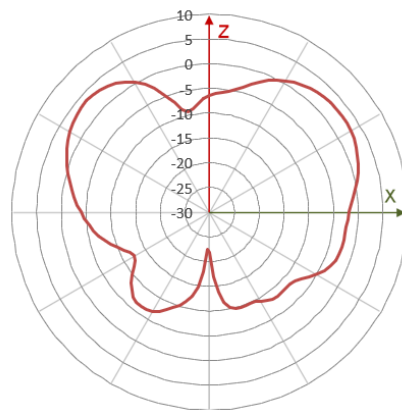

YZ Plane

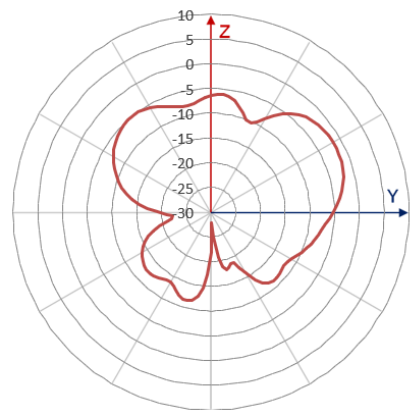

2500MHz

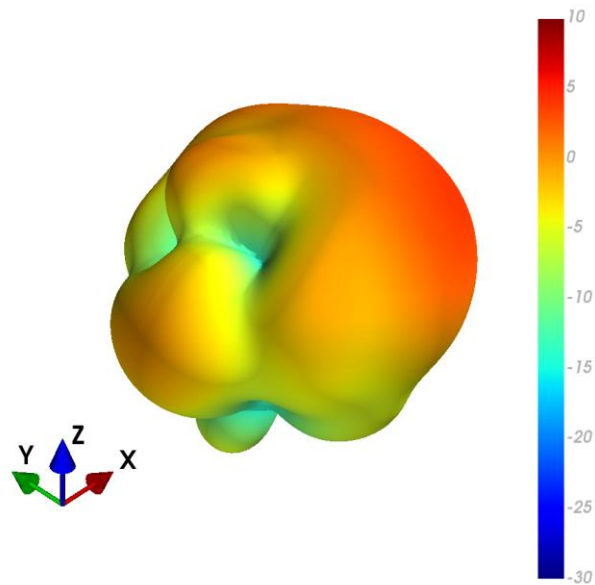

XY Plane

XZ Plane

YZ Plane

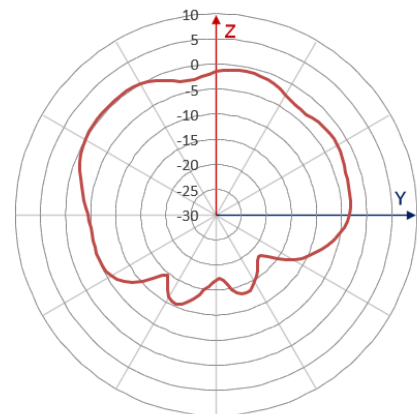
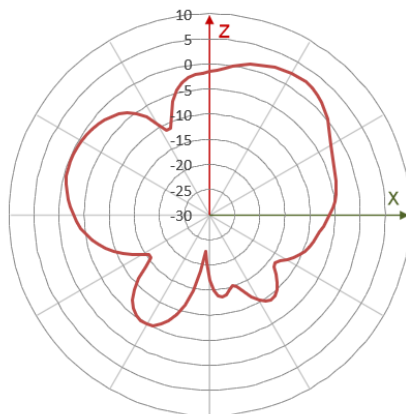
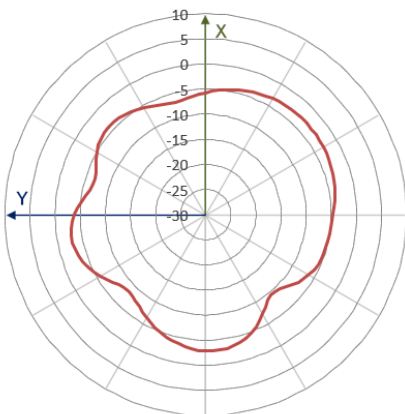

3300MHz

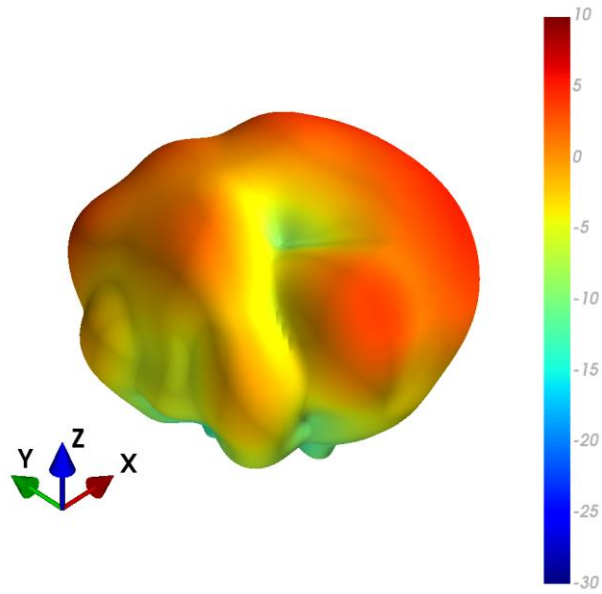

XY Plane

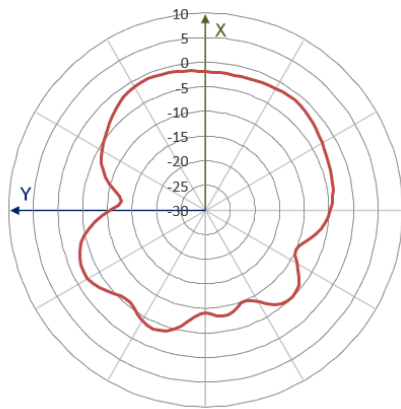

XZ Plane

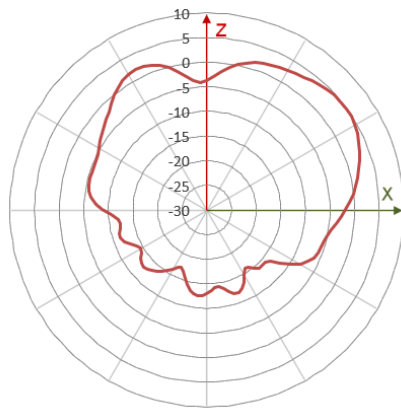

YZ Plane

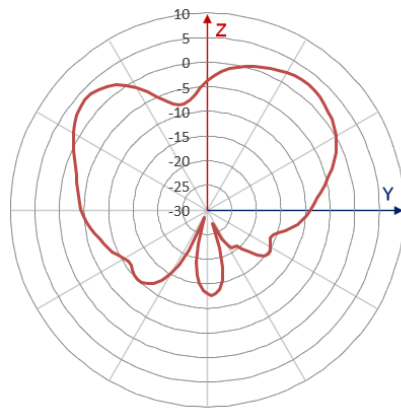

3600MHz

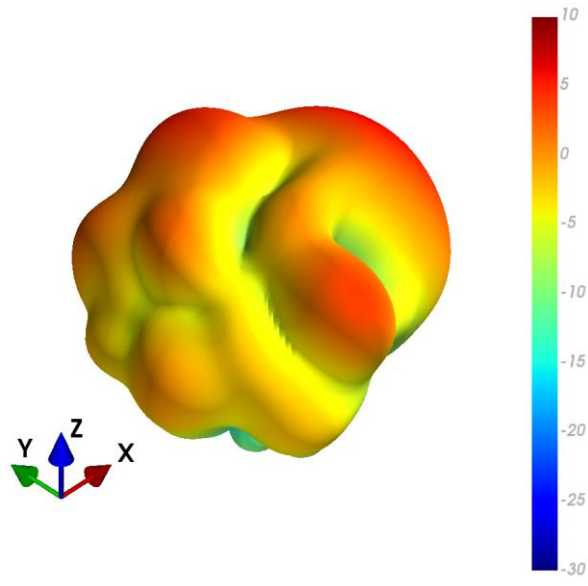

XY Plane

XZ Plane

YZ Plane

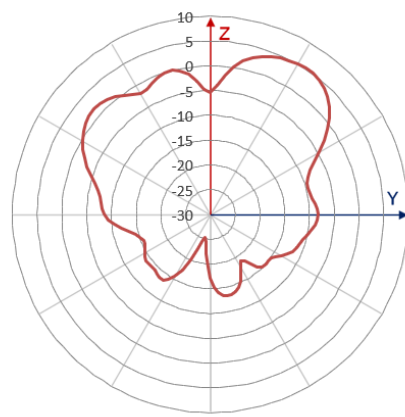
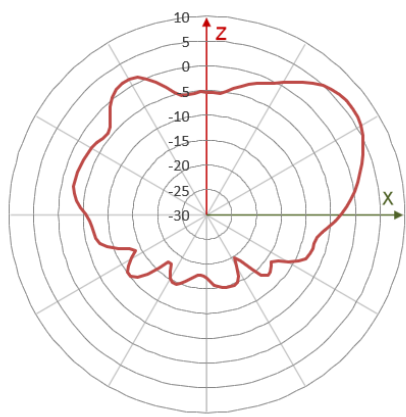
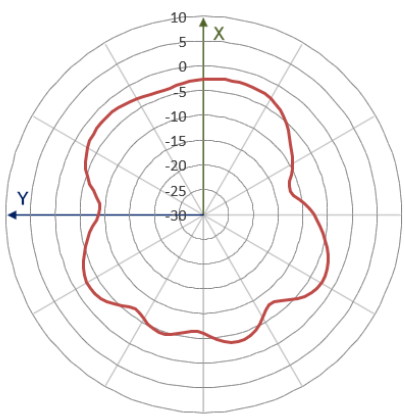

5550MHz

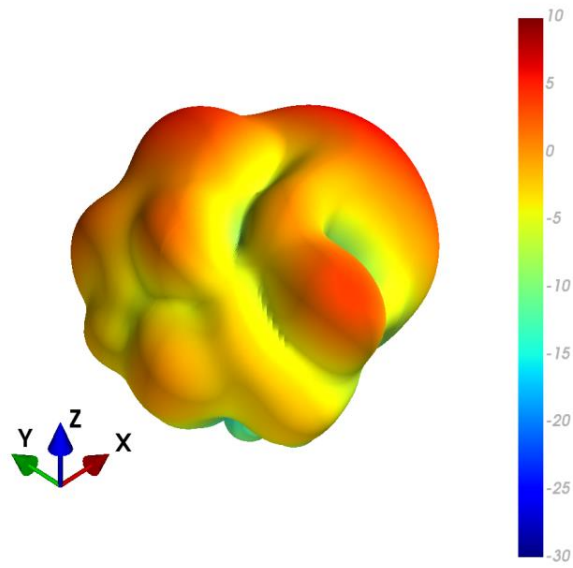

XY Plane

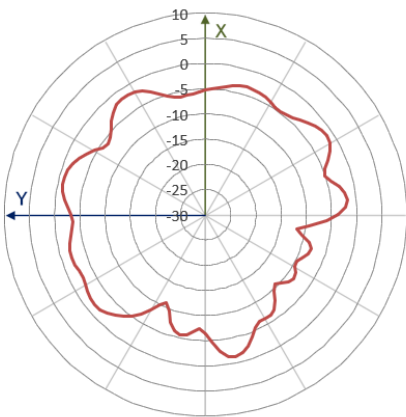

XZ Plane

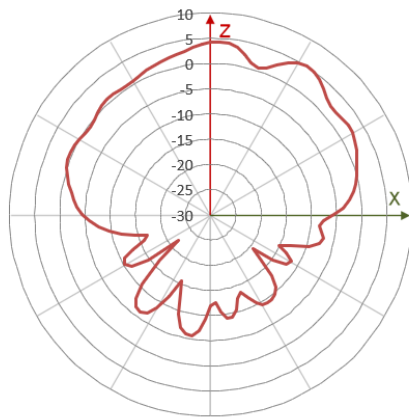

YZ Plane

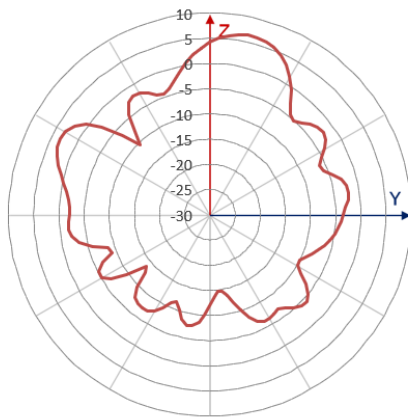

4.4 660MHz - MIMO 3 Radiation Patterns

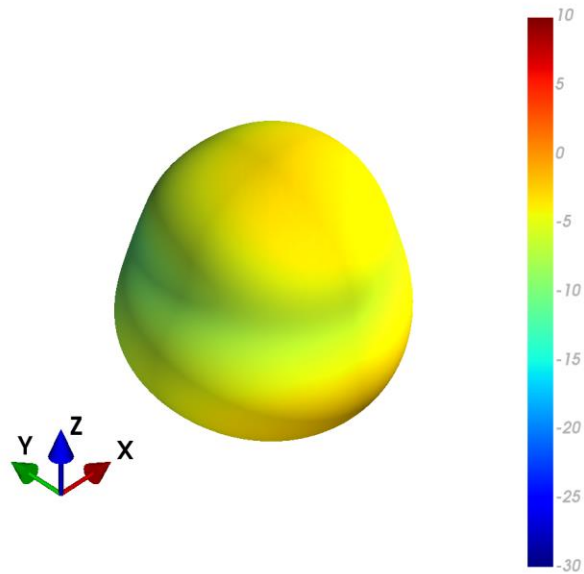

XY Plane XZ Plane YZ Plane

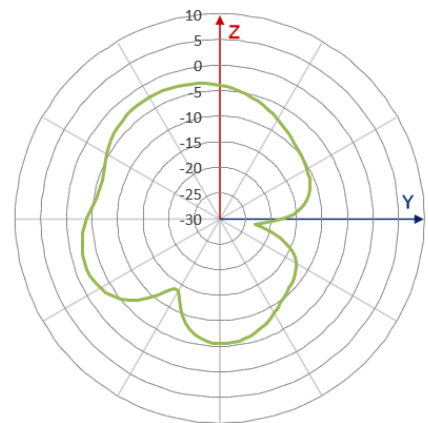
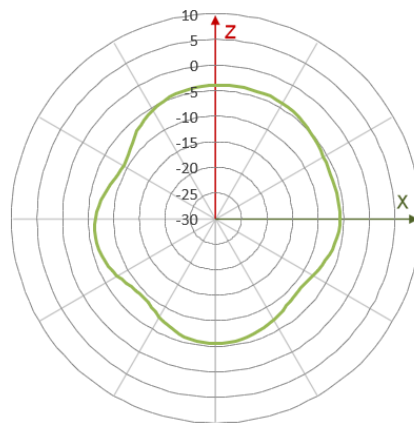
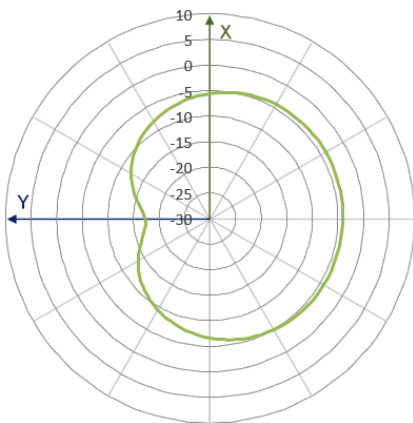

750MHz

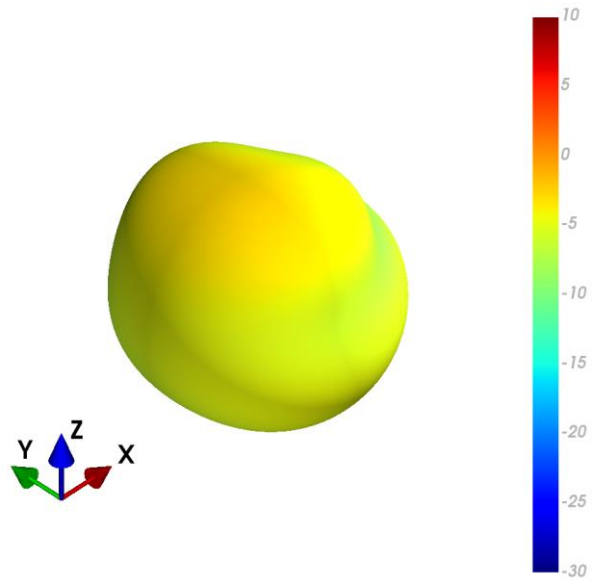

XY Plane

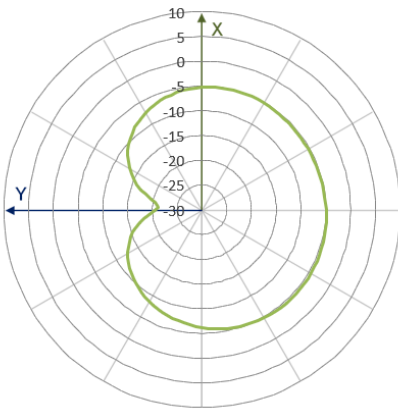

XZ Plane

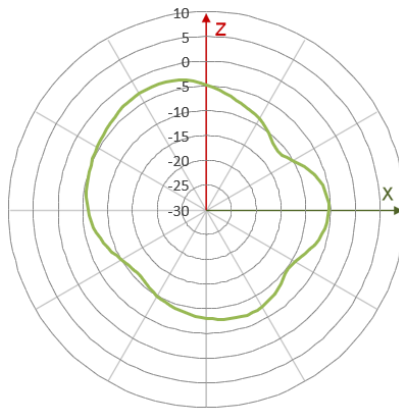

YZ Plane

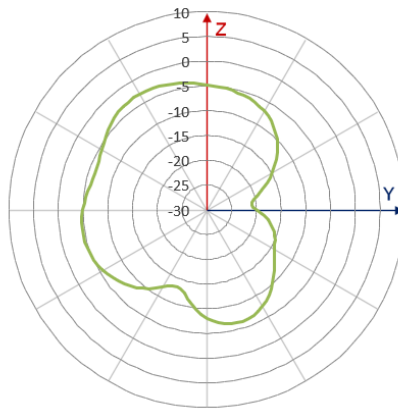

880MHz

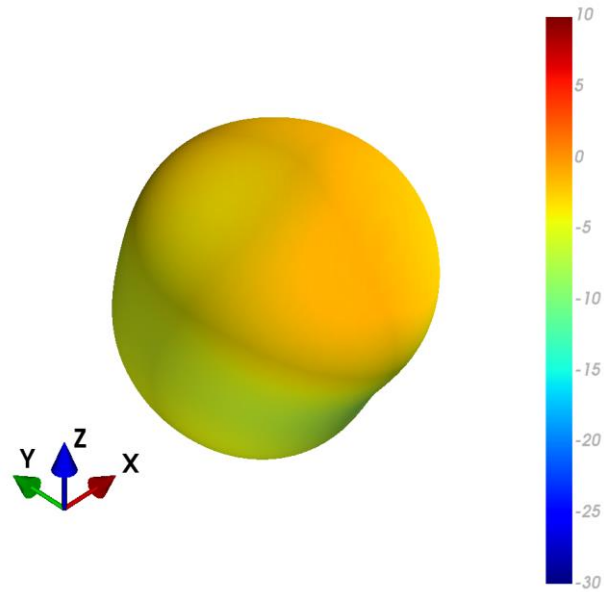

XY Plane

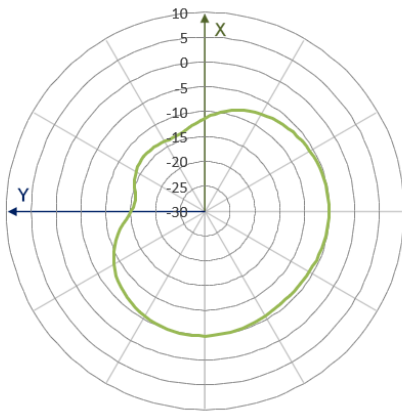

XZ Plane

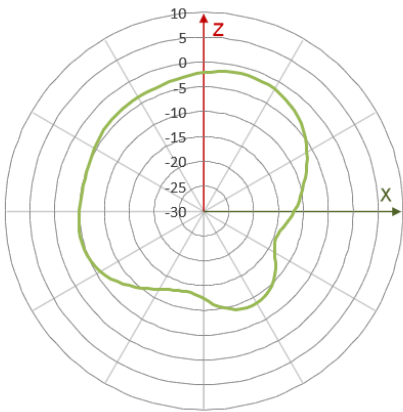

YZ Plane

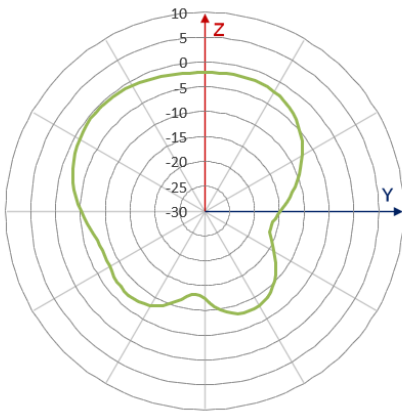

1465MHz

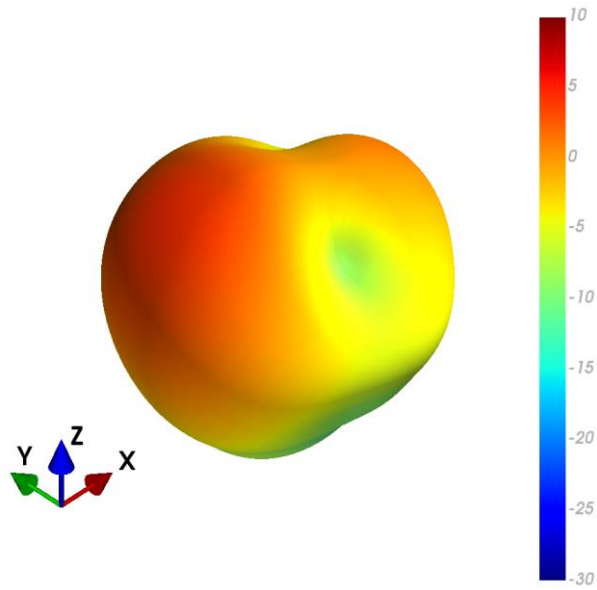

XY Plane

XZ Plane

YZ Plane

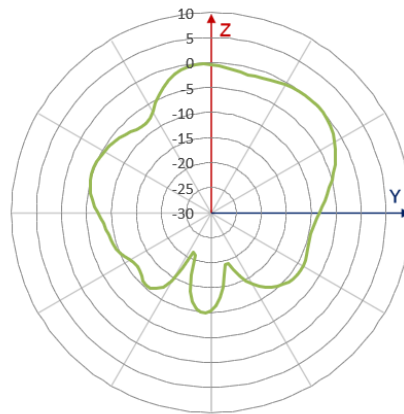
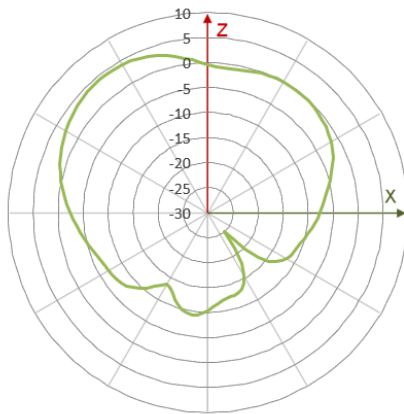
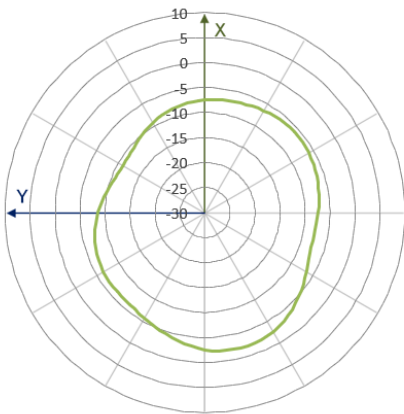

1805MHz

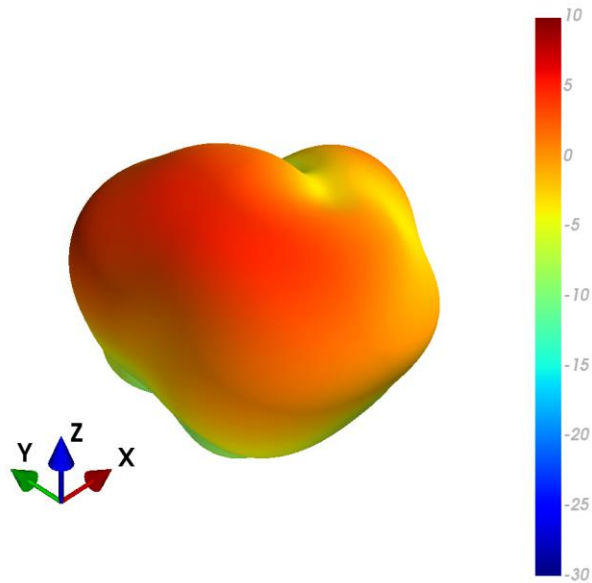

XY Plane

XZ Plane

YZ Plane

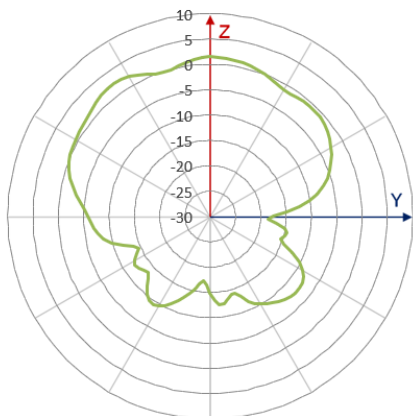
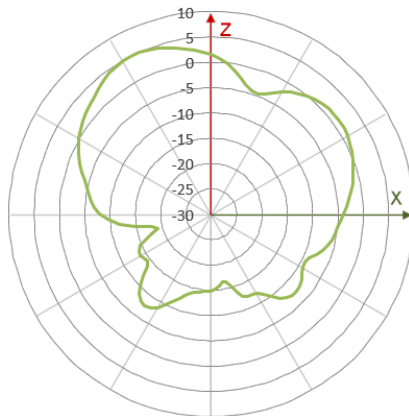
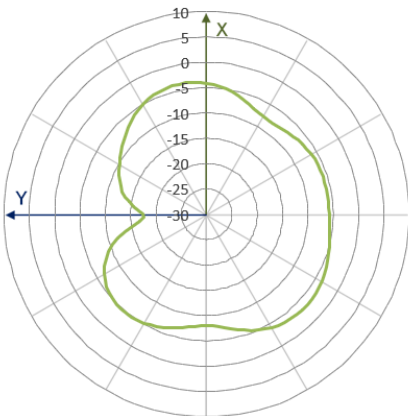

1920MHz

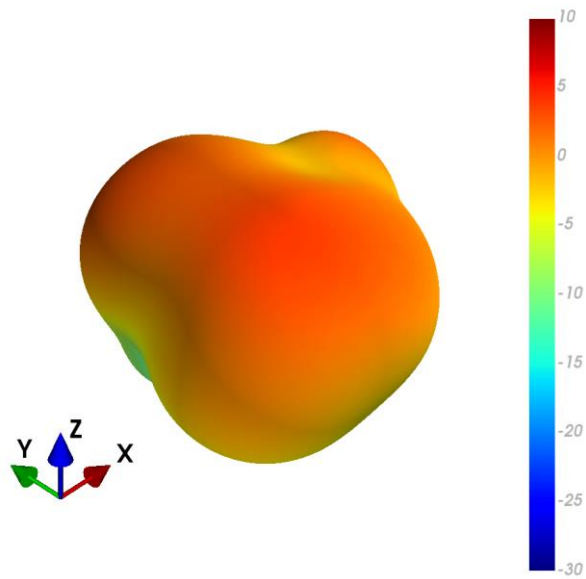

XY Plane

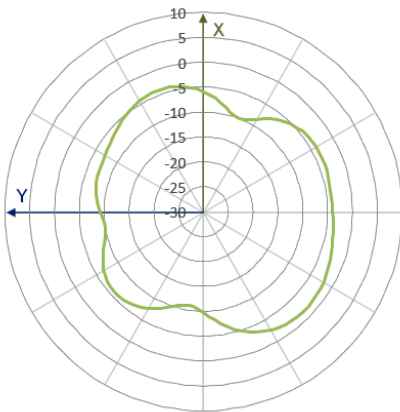

XZ Plane

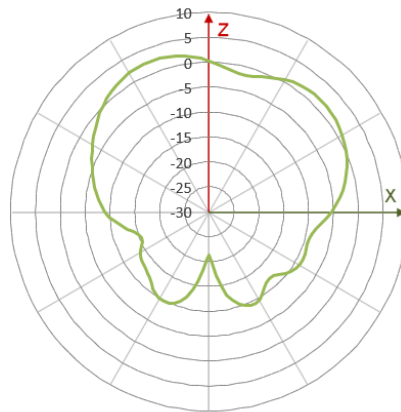

YZ Plane

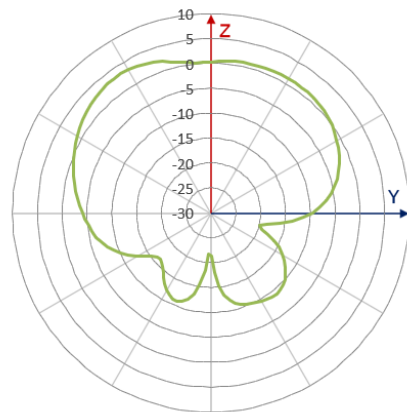

2010MHz

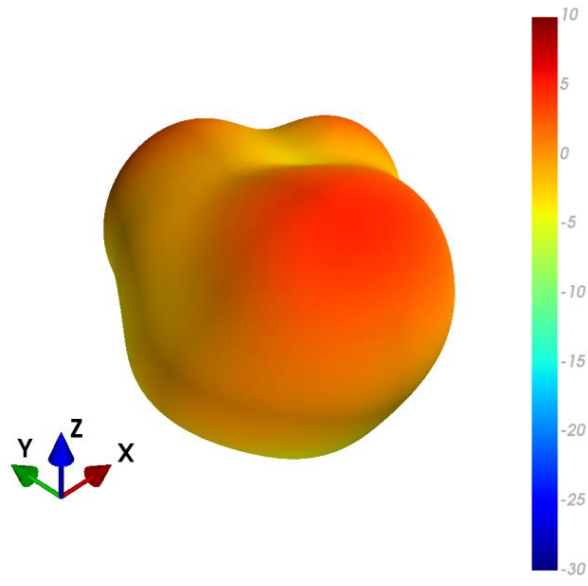

XY Plane

XZ Plane

YZ Plane

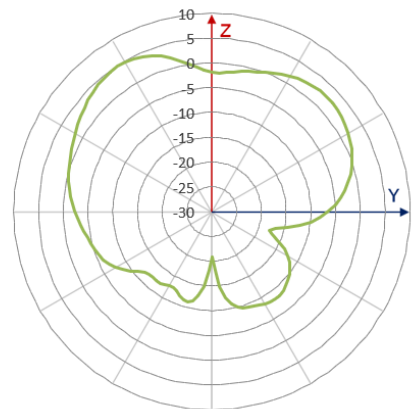
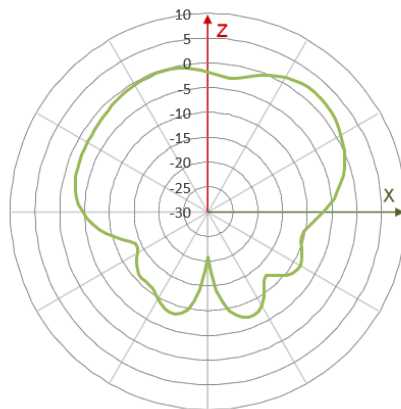
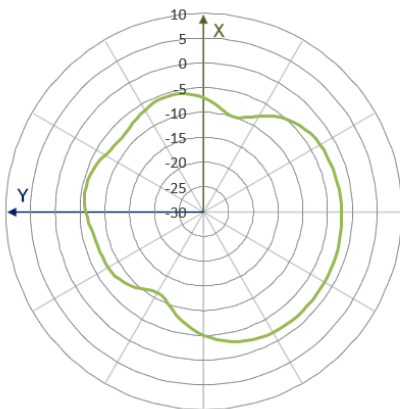

2500MHz

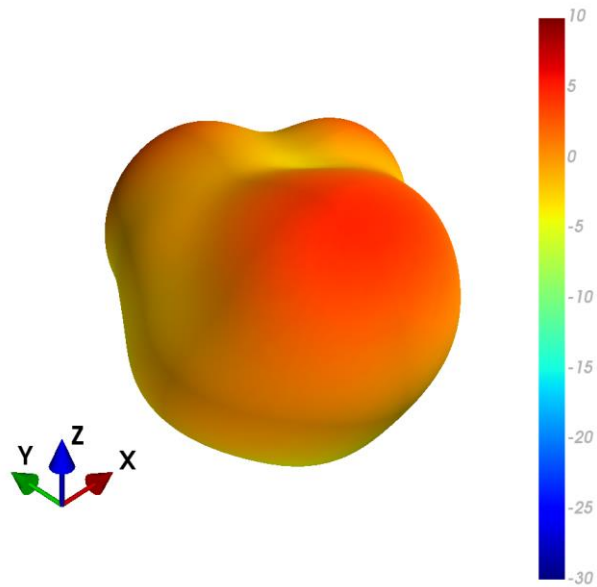

XY Plane

XZ Plane

YZ Plane

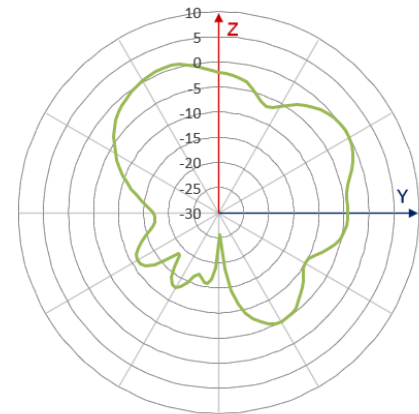
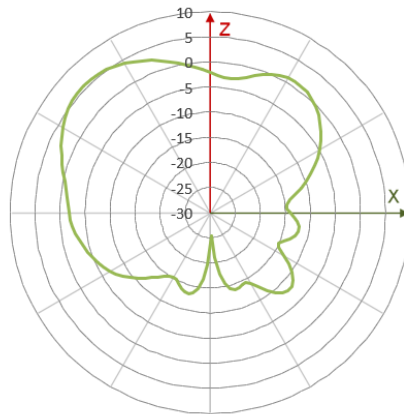
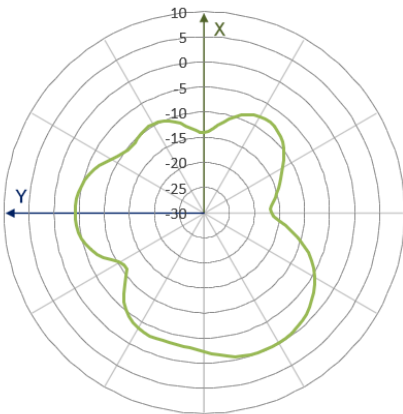

3300MHz

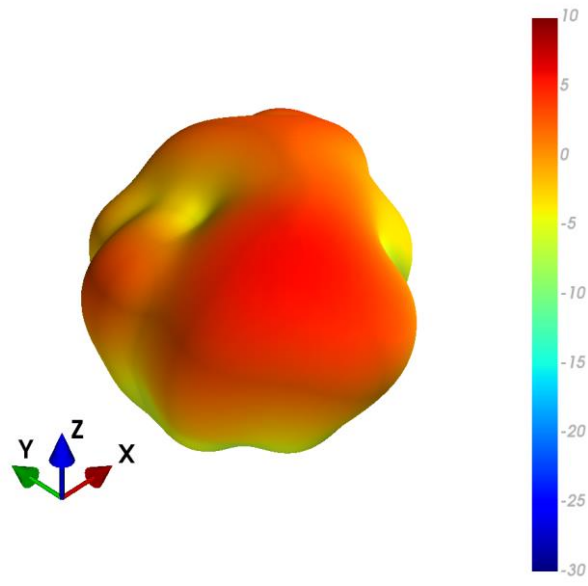

XY Plane

XZ Plane

YZ Plane

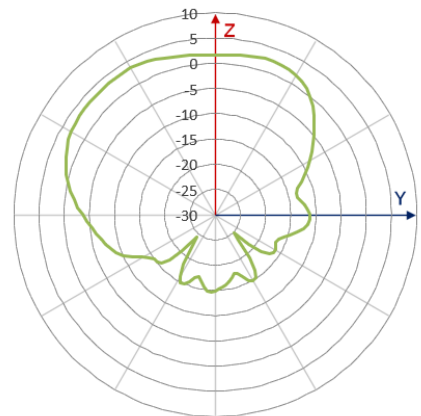
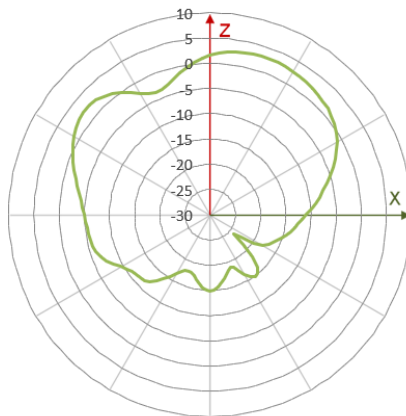
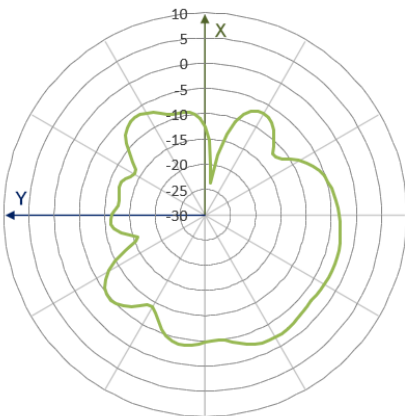

3600MHz

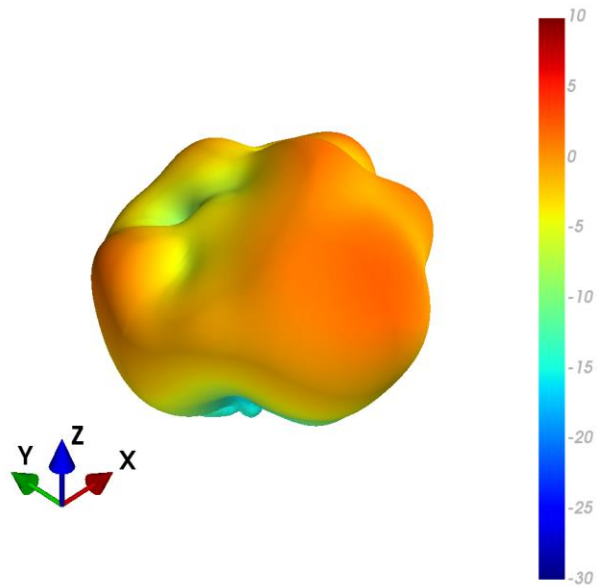

XY Plane

XZ Plane

YZ Plane

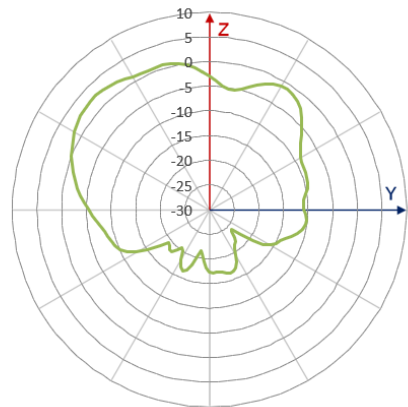
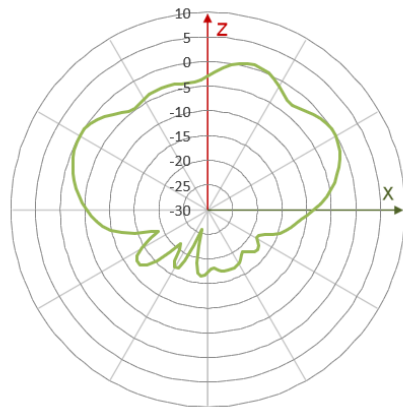
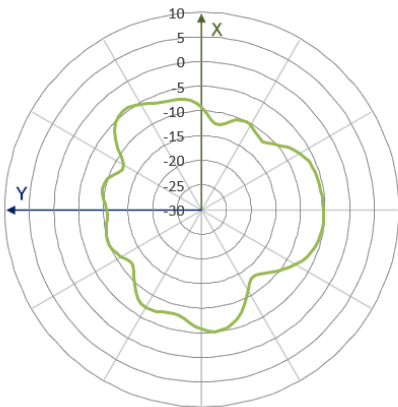

5550MHz

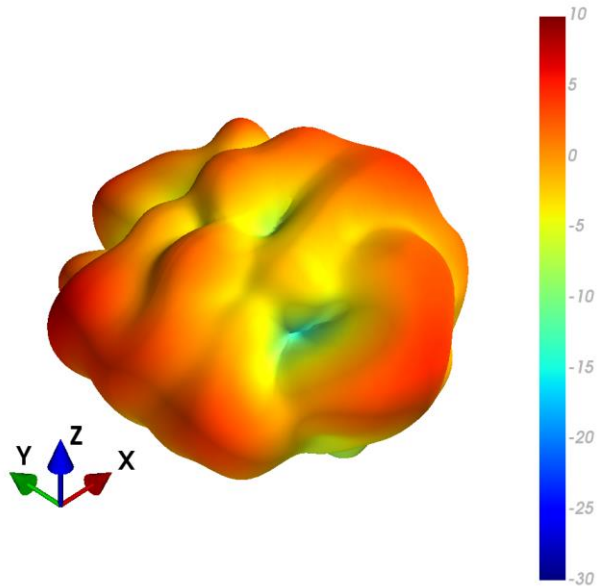

XY Plane

XZ Plane

YZ Plane

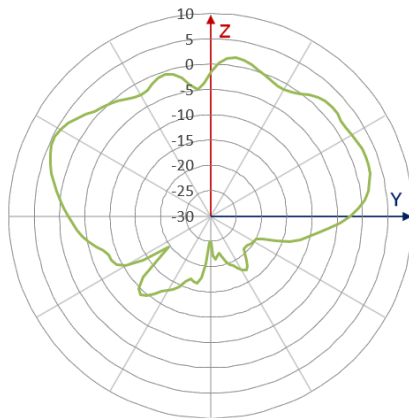
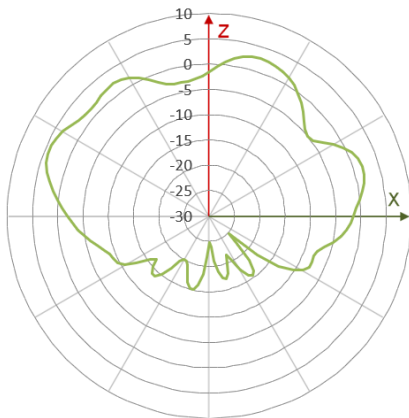
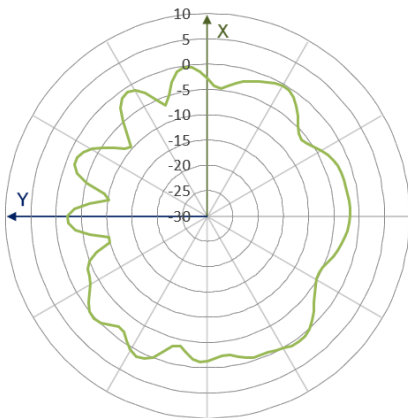

4.5 660MHz - MIMO 4 Radiation Patterns

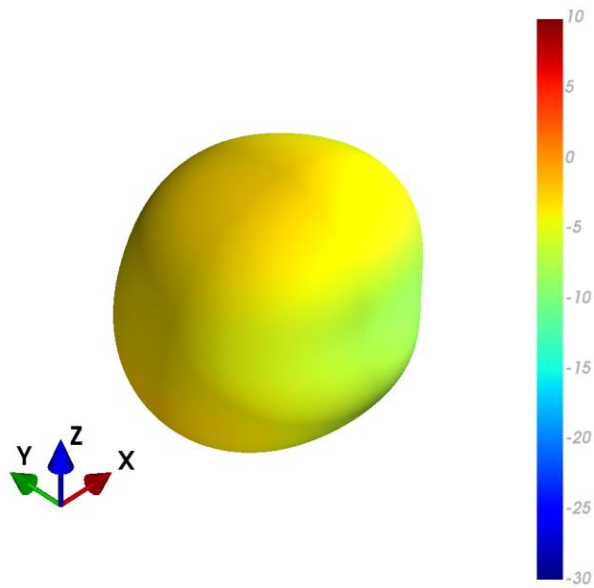

XY Plane XZ Plane YZ Plane

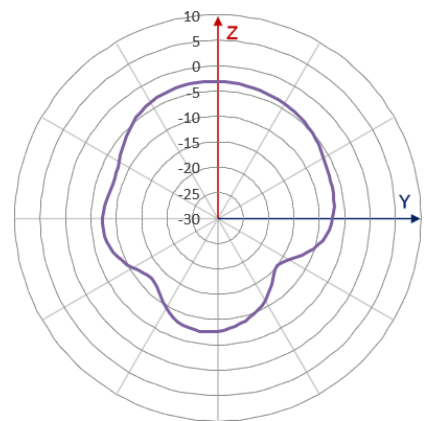
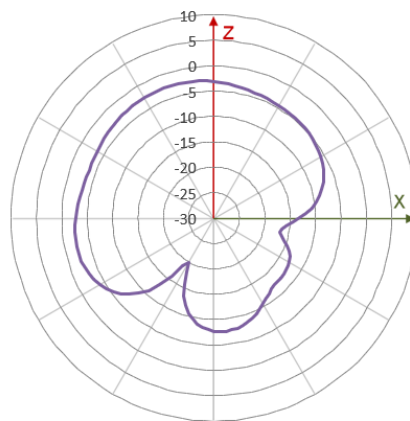
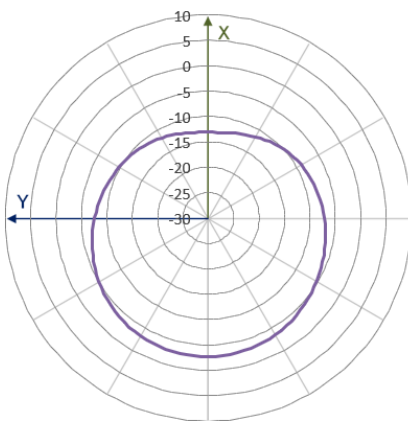

750MHz

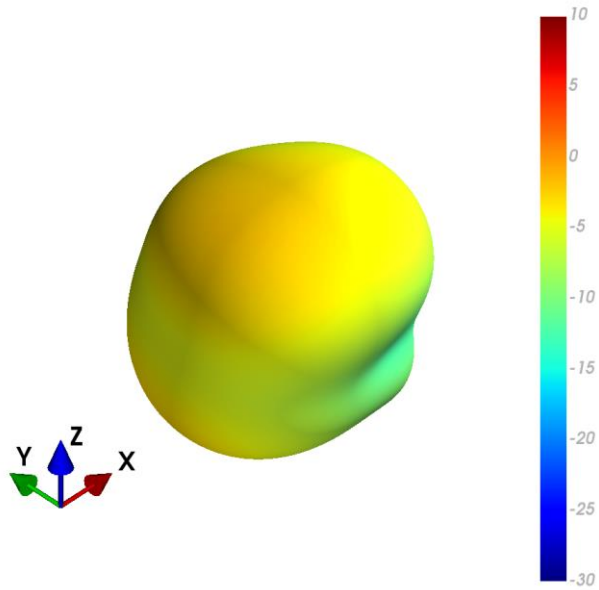

XY Plane

XZ Plane

YZ Plane

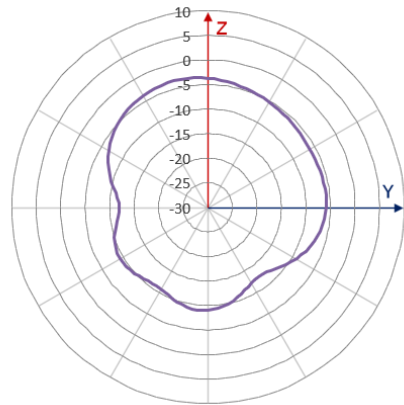
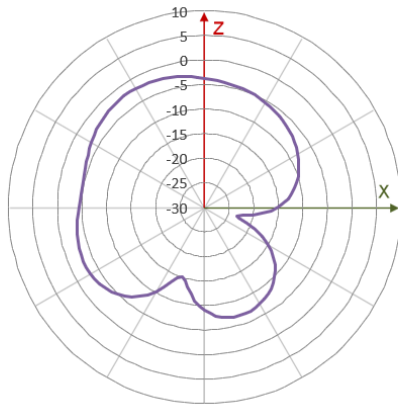
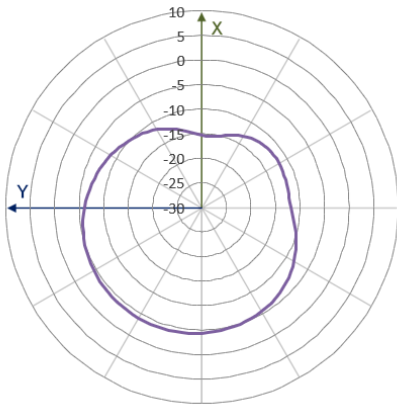

880MHz

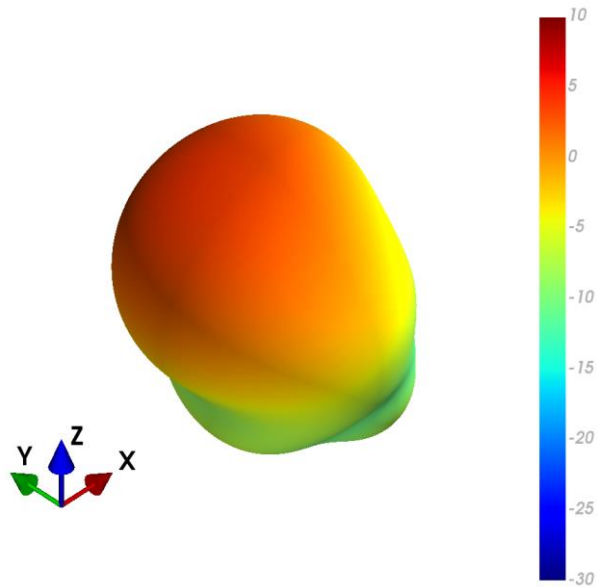

XY Plane

XZ Plane

YZ Plane

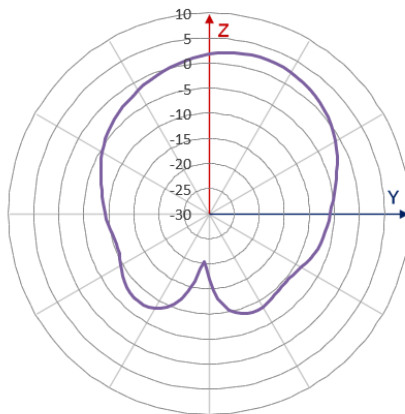
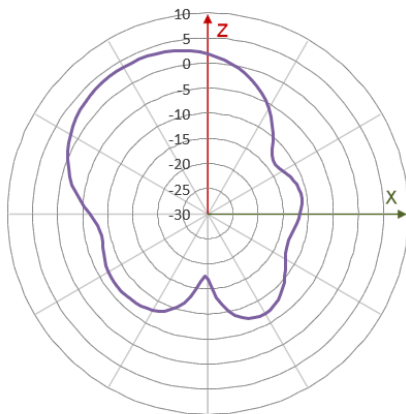
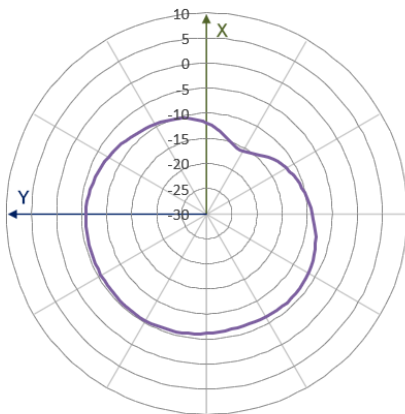

1465MHz

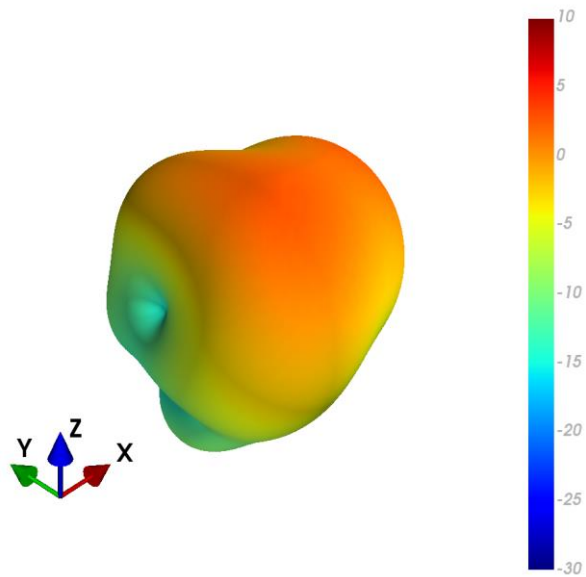

XY Plane

XZ Plane

YZ Plane

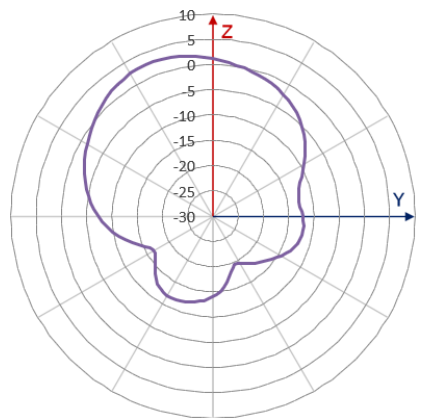
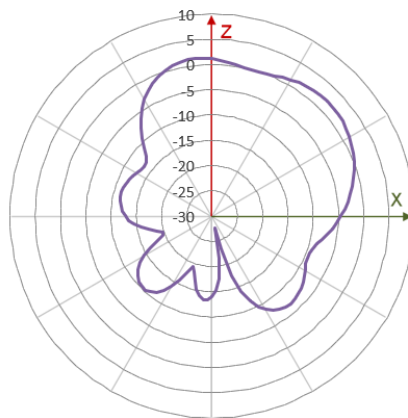
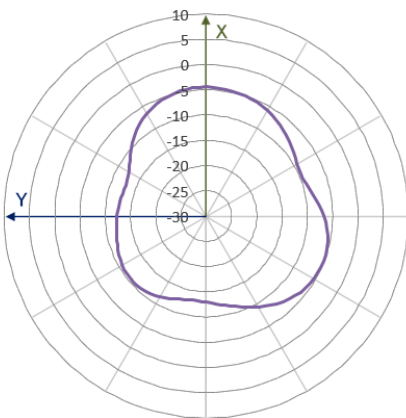

1805MHz

XY Plane

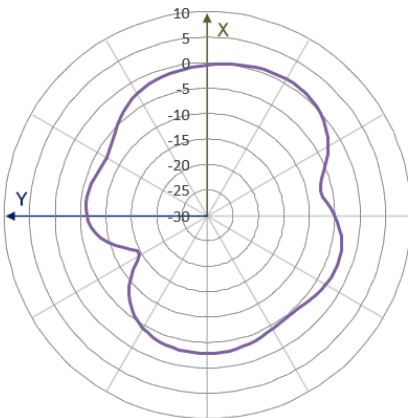

XZ Plane

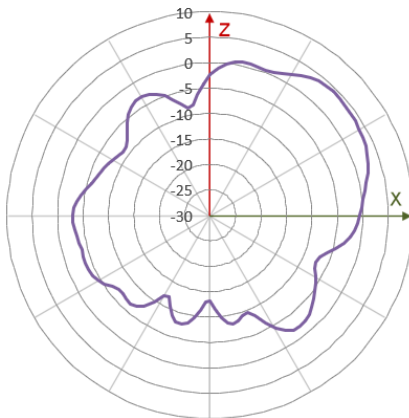

YZ Plane

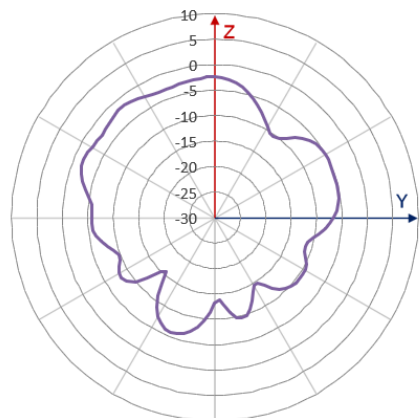

1920MHz

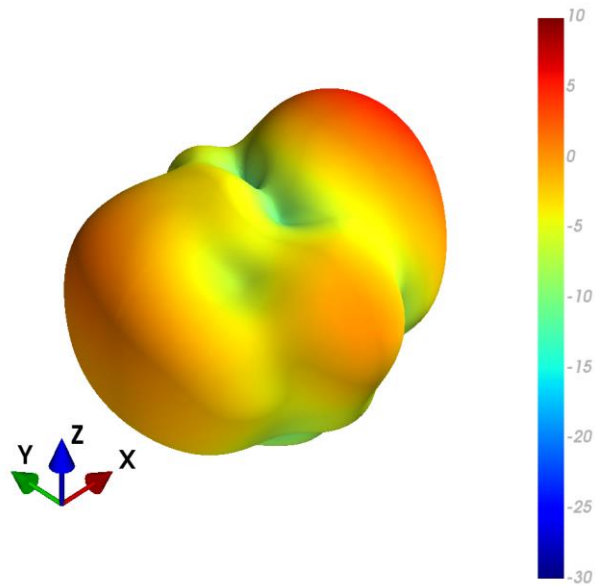

XY Plane

XZ Plane

YZ Plane

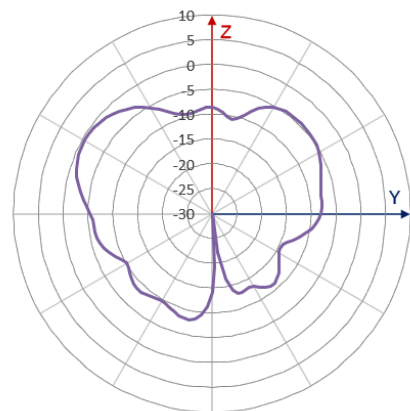
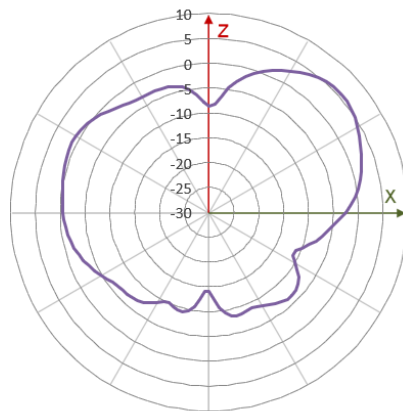
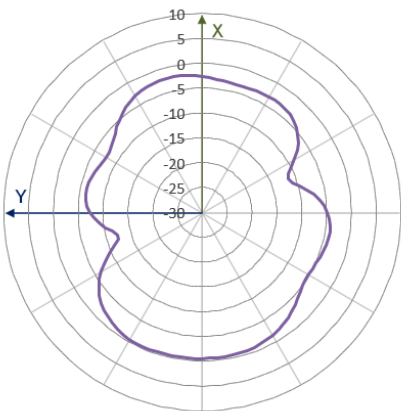

2010MHz

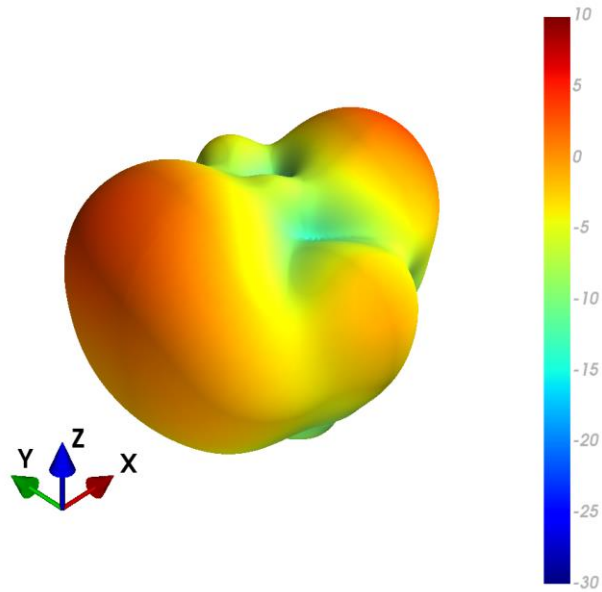

XY Plane

XZ Plane

YZ Plane

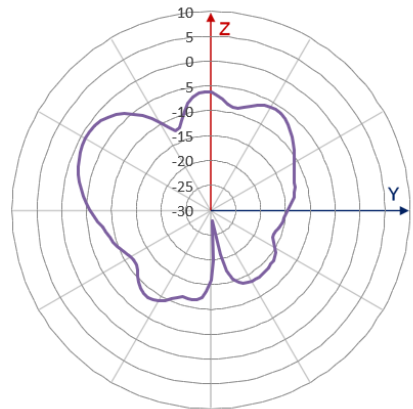
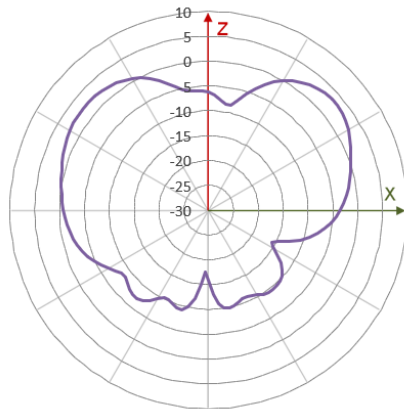
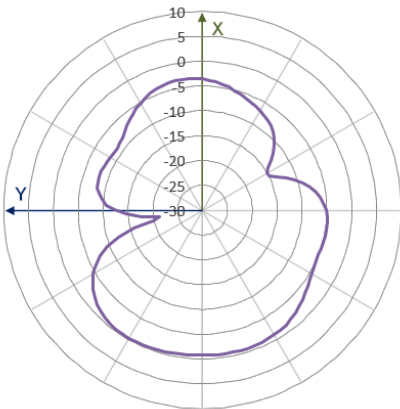

2500MHz

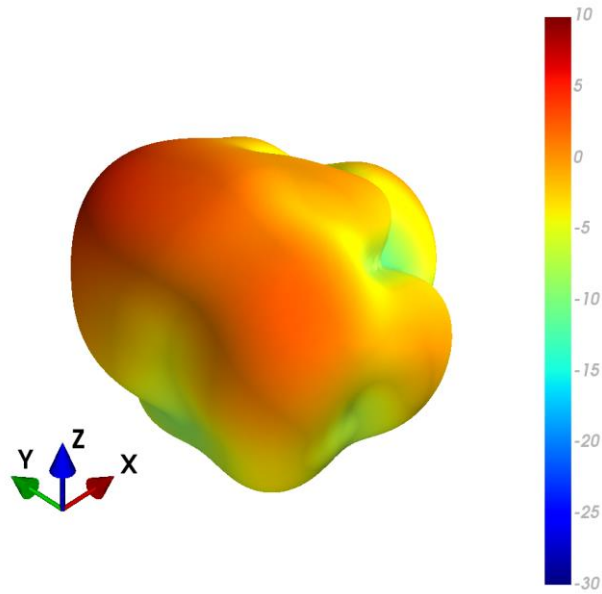

XY Plane

XZ Plane

YZ Plane

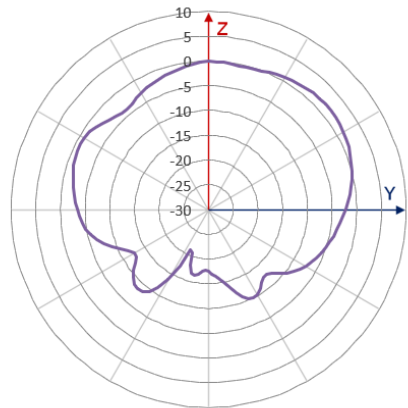
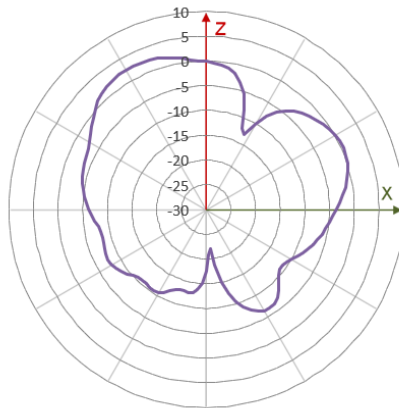
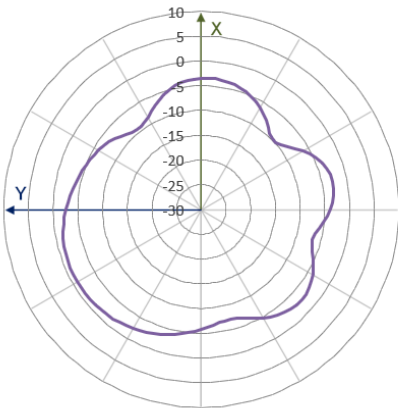

3300MHz

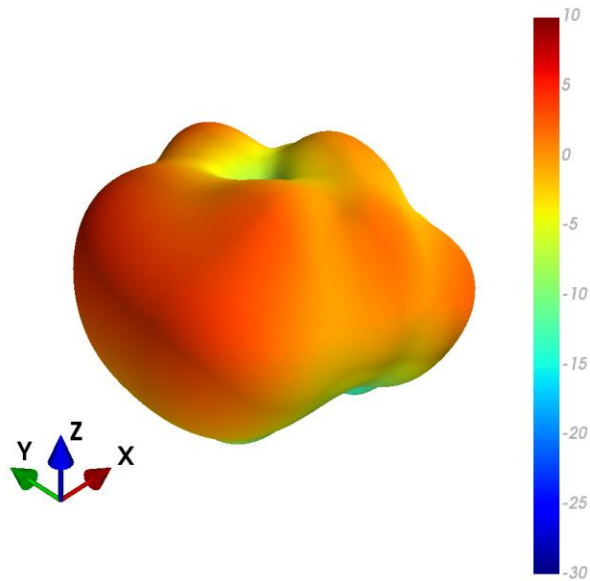

XY Plane

XZ Plane

YZ Plane

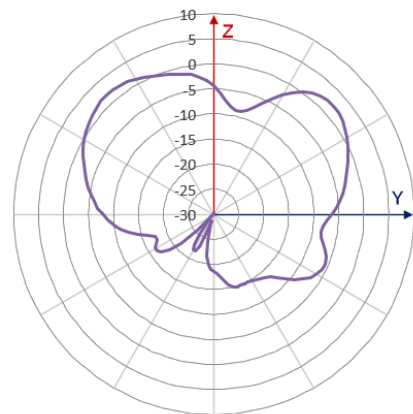
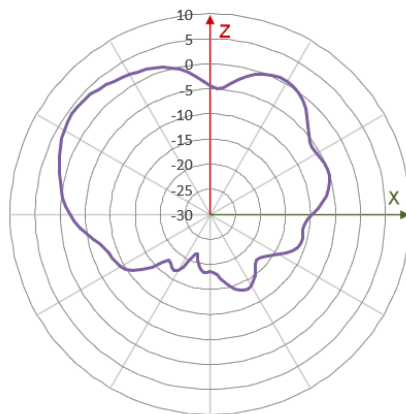
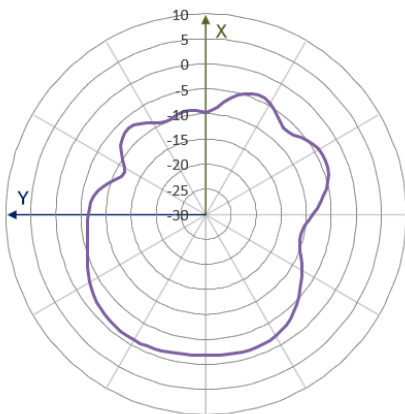

3600MHz

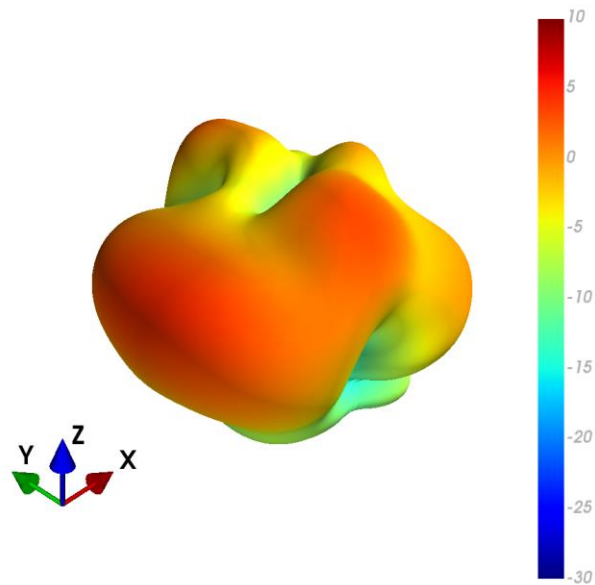

XY Plane

XZ Plane

YZ Plane

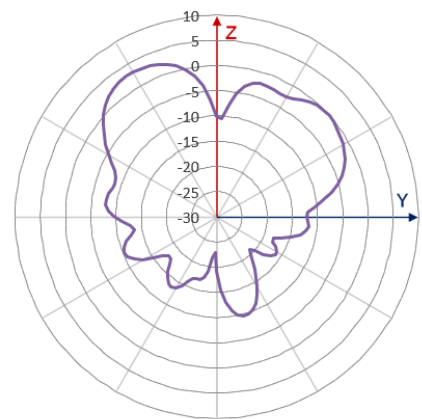
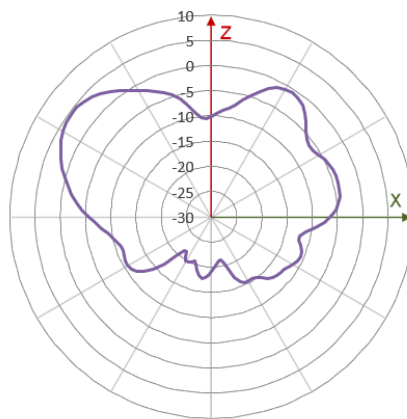
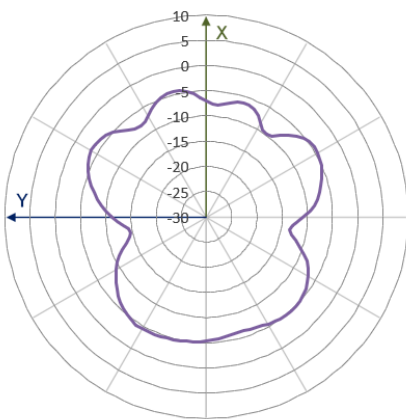

5550MHz

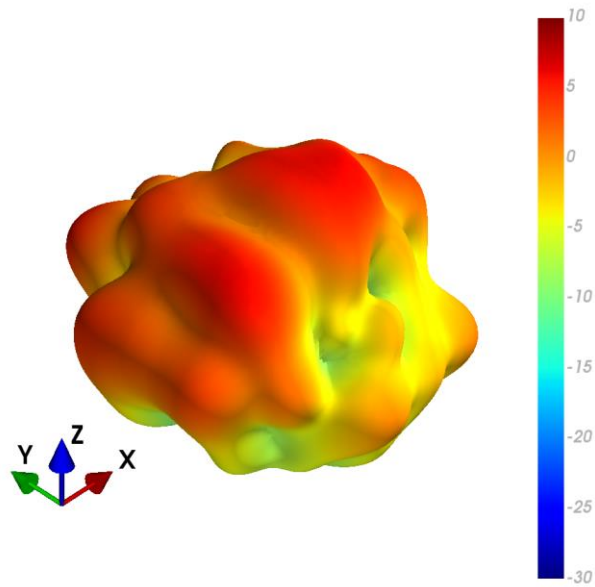

XY Plane

XZ Plane

YZ Plane

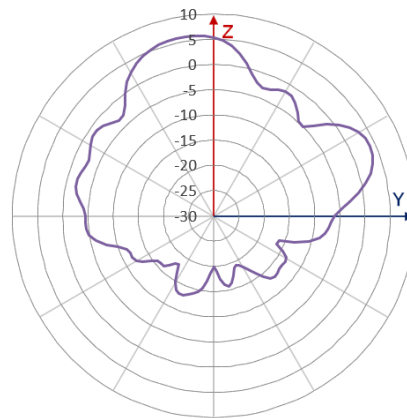
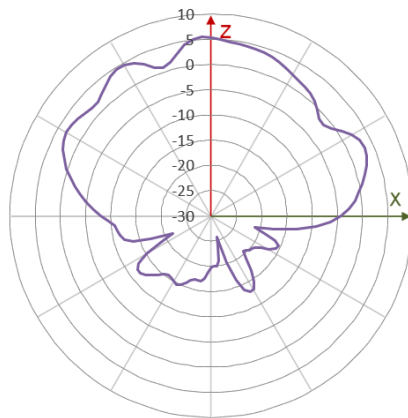
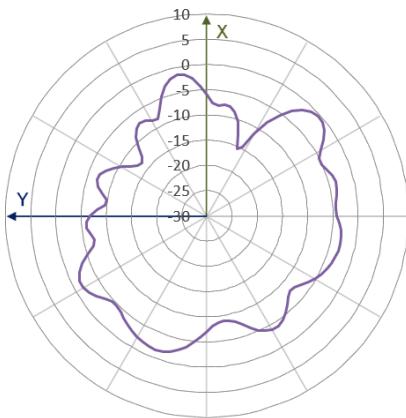

5. Mechanical Drawing (Units: mm)

ISO NO.: IDW-20-8-0048

STATE: Release

NOTES: 1. All material must be RoHS compliant.
2. ** Critical Dimensions.

REV.	DESCRIPTION	ENG.	APPROVED	DATE
001	Initial Design	Ruby	Clark	2020/01/17

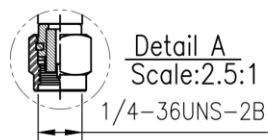
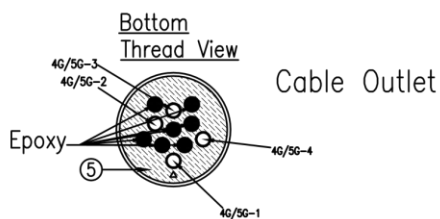
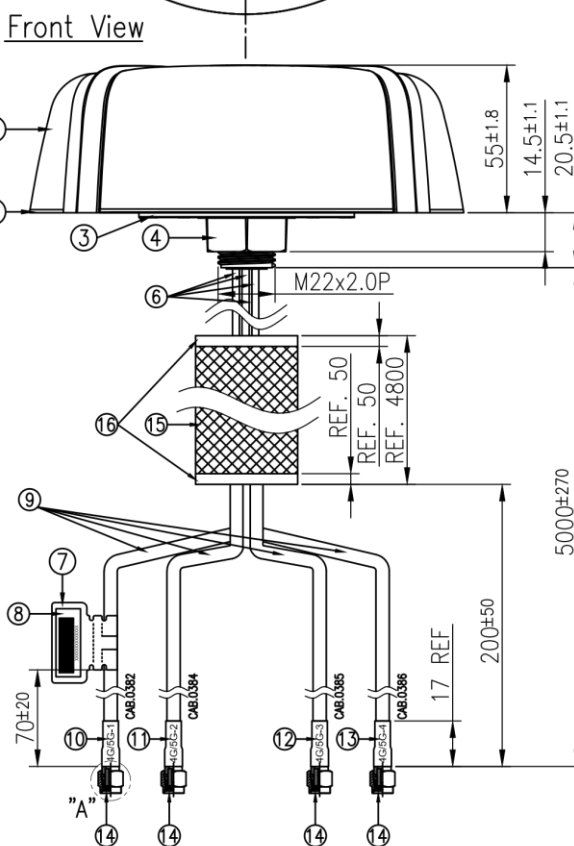
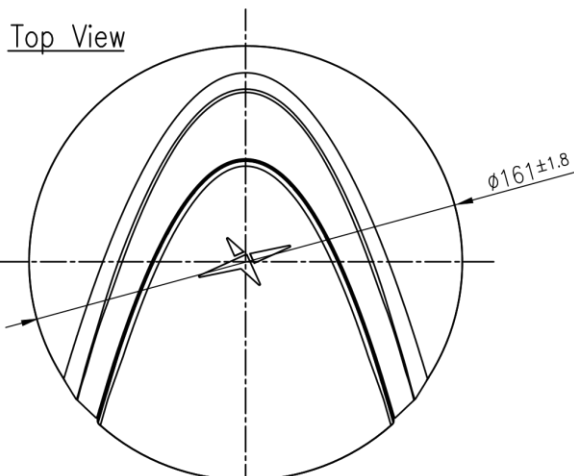

Name	Material	Finish	QTY
1 Top Plastic Shell	PC	Black / Gray	1
2 Bottom Plastic	PC	Black	1
3 Double Sided Adhesive	E4382+3M 9448 2.5T	Black Foam/White Liner	1
4 Nut_M22	Nylon	Black	1
5 Rubber	Silicone Rubber	Black	1
6 BGT4 Coaxial Cable(M1504A001)	PVC	Black	4
7 Empty Label	PEPA	White	1
8 Barcode Label	PET	White	1
9 TGC-200 Coaxial Cable	PE	Black	4
10 Heat Shrink Tube (46/50-1)	PE	Red Tube/White Text	1
11 Heat Shrink Tube (46/50-2)	PE	Red Tube/White Text	1
12 Heat Shrink Tube (46/50-3)	PE	Red Tube/White Text	1
13 Heat Shrink Tube (46/50-4)	PE	Red Tube/White Text	1
14 SMA(M)ST	Brass	Au Plated	4
15 Centenary Braid	BSPET	Black	1
16 Heat Shrink Tube (Braid)	PE With Glue	Black	2

APPROVED BY: Clark	 <small>TW Design Centre</small> This drawing and its inherent design concepts are property of Taoglas. Not to be copied or given to third parties without the written consent of Taoglas.
CHECK BY: Aaron/Kevin	
DRAWN BY: Ruby	
DATE: 2020/01/17	TITLE: Synergy 5m 4in1 5G/4G (MA1504.A.001 + Braided Assembly)
UNLESS OTHERWISE SPECIFIED TOLERANCES ON:	PART NO.: MA1504.AK.001
THIRD ANGLE PROJECTION	UNIT: mm SCALE: 1:2.5 PAGES: 1/1 REV. D01

6. Packaging

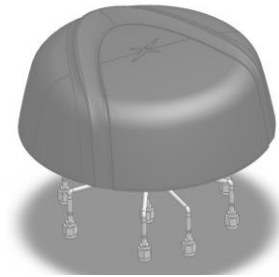

1pc MA1504.AK.001 per PE Bag
Weight: 2Kg

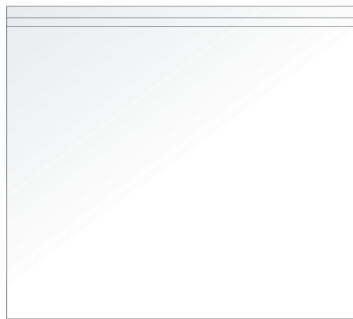

4pcs MA1509.AK.001 per Carton
Carton Dimensions: 740*370*300mm
Weight: 8.4Kg

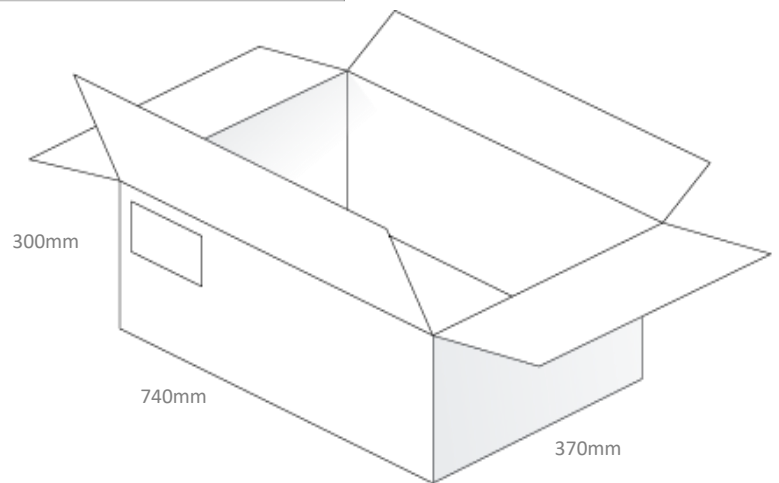

Changelog for the datasheet

SPE-20-8-005 - MA1504.AK.001

Revision: B (Current Version)

Date:	2022-08-16
Notes:	Updated data
Author:	Gary West

Previous Revisions

Revision: A (Original First Release)

Date:	2020-01-14
Notes:	Initial Release
Author:	Jack Conroy