

Features

- Constant Gamma = 1.0, 1.25 & 1.5
- High Q (up to 4000 at -4 Volts)
- More Linear Frequency Tuning
- High and Nearly Constant Modulation Sensitivity
- Lead-Free (RoHS Compliant) equivalents available with 260°C reflow compatibility

Description and Applications

The MA46450, MA46470 and MA46410 series of tuning varactors are hyperabrupt junction Gallium Arsenide diodes featuring constant gamma 1.0 (MA46450 series), 1.25 (MA46470 series) & 1.5 (MA46410 series). These diodes offer high Q (up to 4000) permitting excellent tuning performance from VHF through Ka band. Each part in this series exhibits the large change in capacitance versus bias voltage characteristic of hyperabrupt junctions. The standard capacitance tolerance is $\pm 10\%$, with tighter tolerances available. Capacitance matching at one or more bias voltages is also available. All diode types are available in a wide selection of ceramic packages and in chip form. The constant gamma value of 1.0, 1.25 & 1.5 available with these diodes enables the circuit designer to produce significant improvements in circuit performance. Constant gamma tuning varactors permit more linear VCO frequency tuning than do conventional hyperabrupt tuning varactors. These varactors are particularly well suited for use in voltage tuned filters, analog phase shifters, and modulator circuits.

Packaged Tuning Varactor Equivalent Circuit

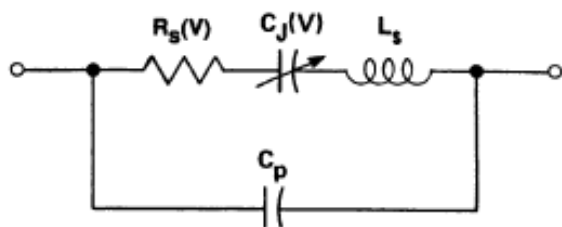

Common Case Styles

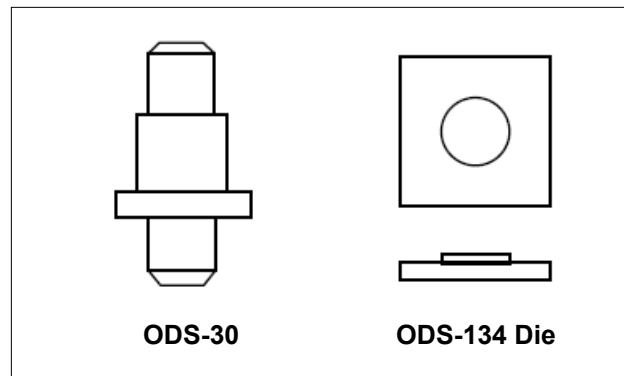

Absolute Maximum Ratings¹ @ T_A = +25 °C (Unless Otherwise Noted)

Parameter	Absolute Maximum
Reverse Voltage	Breakdown Voltage
Operating Temperature	-65°C to +175°C
Storage Temperature	65°C to +200°C

1. Operation of this device above any one of these parameters may cause permanent damage. The maximum storage and operating temperature of the plastic ODS-1088 case style is 125°C.

Typical Junction Capacitance vs. Tuning Voltage

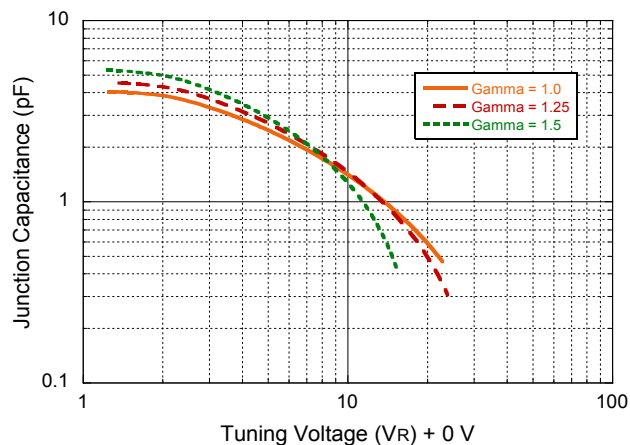

Electrical Specifications²: T_A = +25°C

Gamma = 1.0³ MA46450 Series

Gamma = 0.9 - 1.1, V_R = 2 - 20 Volts
 Junction Capacitance Ratio (C_{J2}/C_{J20}) = 5.0 - 8.0
 Breakdown Voltage @ I_R = 10 μA, V_b = 22 V min.
 Reverse Leakage Current @ V_R = 18 V, I_R = 100 nA max.

Part Number	Total Capacitance +/-10% ^{4,5,6,7}	Total Capacitance Ratio ⁷	Q Minimum
	V _R = 4 V f = 1 MHz	V _R = 2 V / 20 V	V _R = 4 V f = 50 MHz
	(pF)	-	-
MA46450	0.5	2.0-3.8	4000
MA46451	0.7	2.9-4.4	4000
MA46452	1.0	3.6-5.2	3000
MA46457	2.2	4.1-6.1	3000
MA46461	4.7	4.8-7.2	1500

Gamma = 1.25³ MA46470 thru MA46485 Series

Gamma = 1.13 - 1.38, V_R = 2 - 20 Volts
 Junction Capacitance Ratio (C_{J2}/C_{J20}) = 8.15 - 12.99
 Breakdown Voltage @ I_R = 10 μA, V_b = 22 V min.
 Reverse Leakage Current @ V_R = 18 V, I_R = 100 nA max.

Part Number	Total Capacitance +/-10% ^{4,5,6,7}	Total Capacitance Ratio ⁷	Q Minimum
	V _R = 4 V f = 1 MHz	V _R = 2 V / 20 V	V _R = 4 V f = 50 MHz
	(pF)	-	-
MA46470	0.5	2.2-4.1	4000
MA46471	0.7	3.6-5.6	4000
MA46472	1.0	4.8-7.4	3000
MA46473	1.2	4.8-7.4	3000
MA46474	1.5	5.0-7.4	3000
MA46475	1.8	6.6-8.7	3000
MA46476	2.0	6.6-8.7	3000
MA46477	2.2	6.6-8.7	3000
MA46479 ⁸	3.3	6.4-10.0	2000
MA46480	3.7	6.8-11.0	2000
MA46481	4.7	6.9-11.1	1500
MA46483	6.8	7.2-11.5	1500
MA46485	10.0	7.5-12.0	1500

Gamma = 1.5³ MA46410 thru MA46425 Series

Gamma = 1.4 - 1.6 VR = 2 - 12 Volts
 Junction Capacitance Ratio (C_{J2}/C_{J12}) = 6.2 - 10.8
 Breakdown Voltage @ I_R = 10 μA, V_b = 18 V min.
 Reverse Leakage Current @ V_R = 10 V, I_R = 100 nA max.

Part Number	Total Capacitance +/-10% ^{4,5,6,7}	Total Capacitance Ratio ⁷	Q Minimum
	V _R = 4 V f = 1 MHz	V _R = 2 V / 12 V	V _R = 4 V f = 50 MHz
	(pF)	-	-
MA46410	0.30-0.43	2.7-4.3	3000
MA46413	0.90-1.10	4.2-5.7	2500
MA46416	1.62-1.98	5.2-4.9	2500
MA46418	2.42-2.97	5.7-7.6	1800
MA46425	9.00-11.00	6.6-8.8	1200

- All GaAs tuning varactors are available in chip form. Please contact factory for part number information.
- The values guaranteed for gamma are measured on unpackaged chips. The total capacitance versus bias voltage curve will deviate slightly from the chip capacitance versus bias voltage curve due to the package parasitic capacitance (C_p).
- Case parasitics (C_p and L_s) are given for most case styles along with case outlines in the appendix.
- Closer tolerances are available upon request.
- Reverse voltage (V_{br}) is measured at 10 microamps.
- The total capacitance and capacitance ratios shown are for diodes housed in case style 30 with C_p = 0.170 pF unless otherwise specified. Other case styles will result in different values.
- This part is offered in die form, shipped in a gel pack. The part number is MAVR-046479-01340G.

Typical Performance Curves

Gamma vs. Reverse Bias Voltage

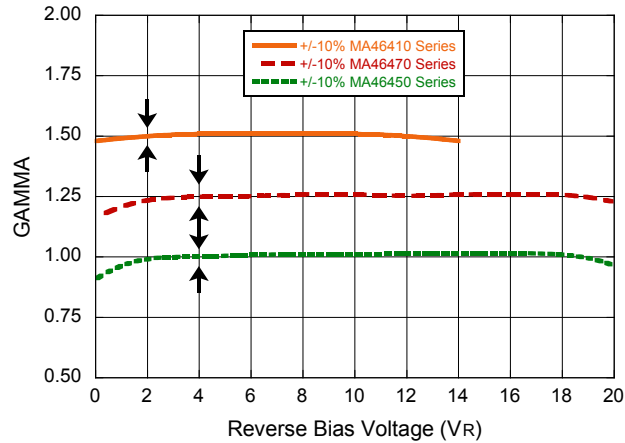

Gamma = 1.0
Total Capacitance vs. Reverse Bias Voltage
(Packaged parts in case style ODS-30)

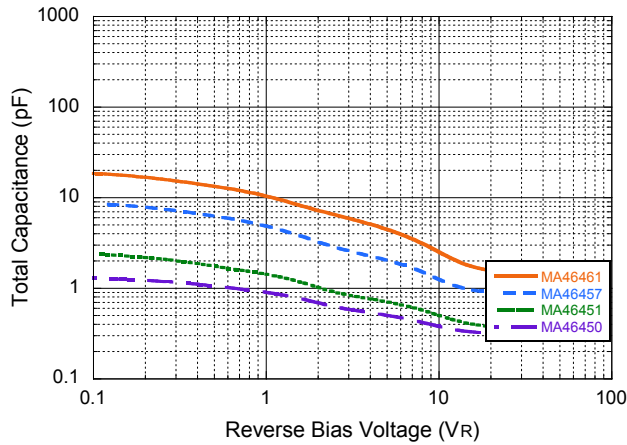

Gamma = 1.0
Junction Capacitance vs. Reverse Bias Voltage
(DIE)

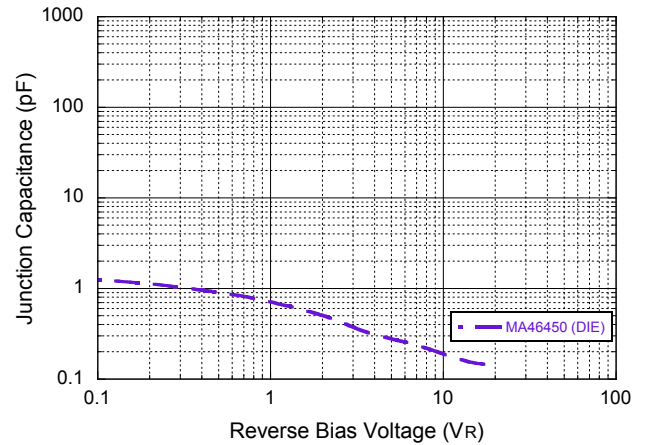

Typical Performance Curves

Gamma = 1.25

Total Capacitance vs. Reverse Bias Voltage
(Packaged parts in case style ODS-30)

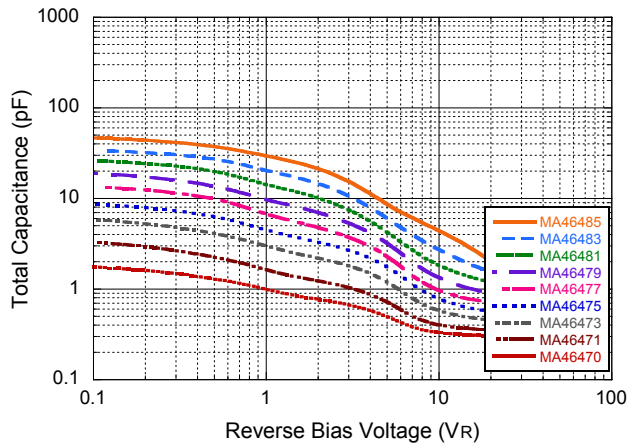

Gamma = 1.25

Junction Capacitance vs. Reverse Bias Voltage
(DIE)

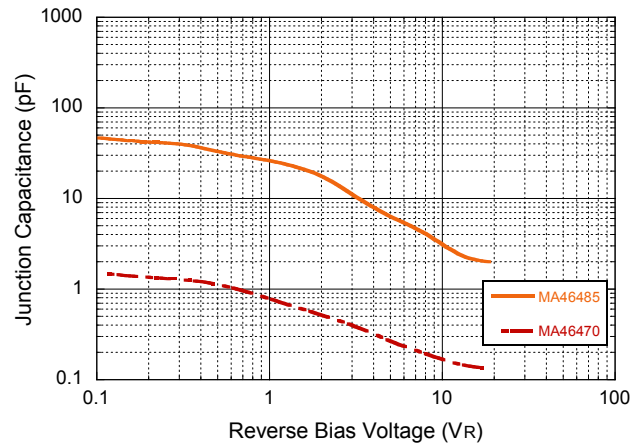

Gamma = 1.5

Total Capacitance vs. Reverse Bias Voltage
(Packaged parts in case style ODS-30)

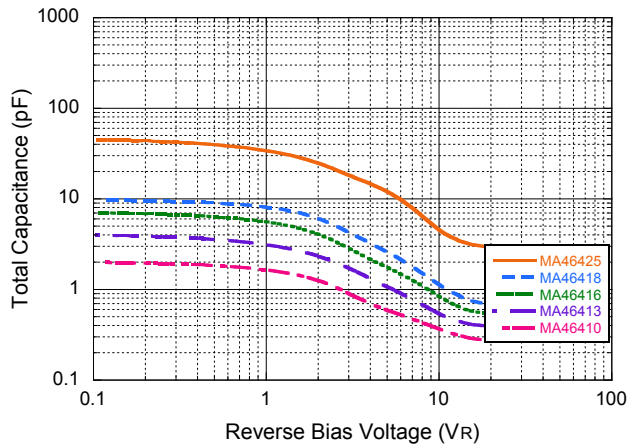

Gamma = 1.5

Junction Capacitance vs. Reverse Bias Voltage
(DIE)

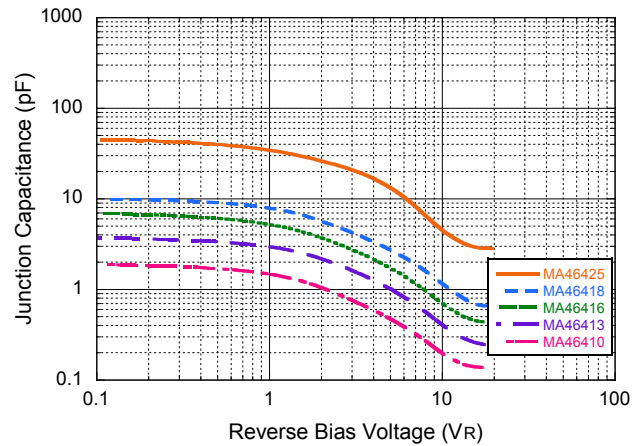

MA46410 thru MA46480 Series



GaAs Hyperabrupt Varactor Diode
Gamma = 1.0, 1.25, & 1.5

Rev. V7

Environmental Ratings per MIL-STD-750

Parameter	Method	Level
Storage Temperature	1031	See Absolute Maximum Ratings
Temperature Cycle	1051	10 cycles, -65°C to +175°C
Shock	2016	500 g's
Vibration	2056	15 g's

Case Styles (Dimensions are available upon request)

Typical Coaxial Packages

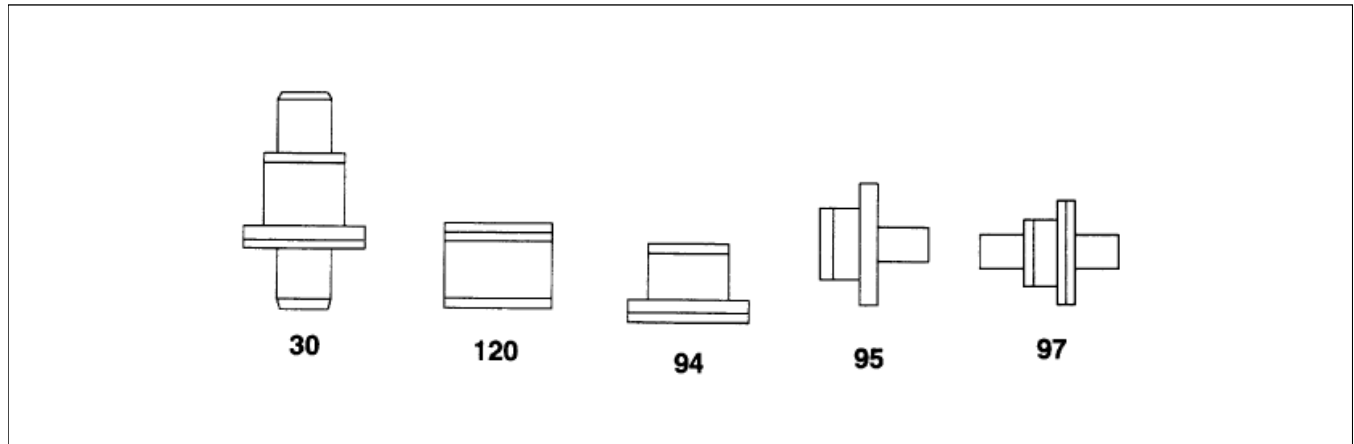

Typical Coplanar Packages

