

Surface Mount GaAs Tuning Varactors 0.75, 1.25, & 1.5 Gamma Hyperabrupt

Rev. V8

Features

- Gamma Hyperabrupt Junctions: 0.75, 1.25 and 1.5
- Surface Mount Packages
- Very High Quality Factor
- Capacitance Ratio to 10:1
- Case Style 1056 is Hermetic and may be Screened to JANTX levels
- Tape and Reel Packaging Available

Description

MACOM offers three families of low cost surface mount gallium arsenide tuning varactors. All families have silicon nitride protected junctions for low leakage current and high reliability.

The **MA46H070** through **MA46H073** family has hyperabrupt junctions with constant gamma of 0.75 from 0 to 20 volts and very high quality factor approaching that of abrupt junction varactors, but higher capacitance change versus tuning voltage. These diodes are very well suited for narrow bandwidth VCOs and VTFs where wide tuning range and very high quality factor are required.

The **MA46H200** through **MA46H204** family has hyperabrupt junctions with constant gamma of 1.25 from 2 to 20 volts and has the largest capacitance ratio of the families of GaAs varactors and high quality factor. These diodes are very well suited for wide bandwidth VCOs and VTFs where the optimum combination of very wide tuning range and high quality factor is required.

The **MA46H500** through **MA46H504** family has hyperabrupt junctions with constant gamma of 1.5 from 2 to 12 volts and high quality factor. Designed for wide bandwidth VCOs and VTFs where limited bias voltage is available. These varactors have lower quality factor than the other families of GaAs varactors.

Common Case styles

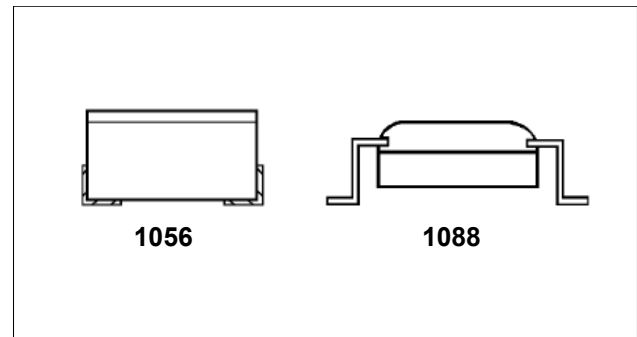

Packaged Tuning Varactor Equivalent Circuit

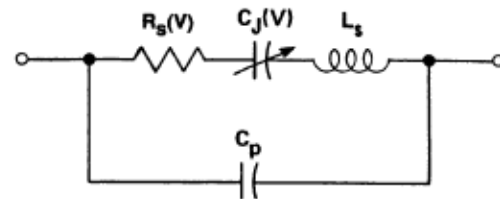

Absolute Maximum Ratings^{1,2}

Parameter	Absolute Maximum	
	Case 1056	Case 1088
Operating Temperature	-65°C to +150°C	-65°C to +125°C
Storage Temperature	-65°C to +200°C	-65°C to +125°C
Reverse Voltage	Breakdown Voltage	
Forward Current	50 mA @ 25°C	
Power Dissipation	50 mW @ 25°C, de-rate linearly to 0 mW @ maximum operating temperature	

1. Exceeding any one or combination of these limits may cause permanent damage to this device.
2. MACOM does not recommend sustained operation near these survivability limits.

Electrical Specifications: $T_A = +25^\circ\text{C}$

0.75 Gamma Hyperabrupt

Breakdown Voltage @ 10 μA = 20 V minimum
 Reverse Current @ 16 V = 100 nA maximum
 Gamma³ = 0.68 - 0.83, VR = 0 to 20 V @ 10 μA

Part Number	Total Capacitance +/-10% ^{4,5,6}	Total Capacitance Ratio ⁶	Q Minimum
	Vr=4 V	Vr=0 V	Vr=4 V
	(pF)	-	-
MA46H070	0.5 - 0.7	5.5	4500
MA46H071	0.9 - 1.1	6.4	4500
MA46H072	2.7 - 3.3	7.5	3000
MA46H073	4.5 - 5.5	7.5	2200

1.25 Gamma Hyperabrupt

Breakdown Voltage @ 10 μA = 22 V minimum
 Reverse Current @ 16 V = 100 nA maximum
 Gamma³ = 1.13 - 1.38, VR = 2 to 20 V @ 10 μA

Part Number	Total Capacitance +/-10% ^{4,5,6}	Total Capacitance Ratio ⁶	Q Minimum
	Vr=4 V	Vr=2 V	Vr=4 V
	(pF)	-	-
MA46H200	0.5 - 0.7	3.0	1500
MA46H201	0.9 - 1.1	4.1	3000
MA46H202 ⁷	2.7 - 3.3	5.6	2000
MA46H203	4.5 - 5.5	10.0	1500
MA46H204	9.0 - 11.0	10.0	1500

1.5 Gamma Hyperabrupt

Breakdown Voltage @ 10 μA = 18 V minimum
 Reverse Current @ 14 V = 100 nA maximum
 Gamma³ = 1.4 - 1.6, VR = 2 to 12 V @ 10 μA

Part Number	Total Capacitance +/-10% ^{4,5,6}	Total Capacitance Ratio ⁶	Q Minimum
	Vr=4 V	Vr=2 V	Vr=4 V
	(pF)	-	-
MA46H500	0.5 - 0.7	2.8	2500
MA46H501	0.9 - 1.1	3.9	2500
MA46H503	4.5 - 5.5	8.1	1200
MA46H504	9.0 - 11.0	8.1	1200

- The values guaranteed for gamma are measured on unpackaged chips. The total capacitance versus bias voltage curve will deviate slightly from the chip capacitance versus bias voltage curve due to the package parasitic capacitance (Cp).
- The Cp values listed typically have tolerances of ± 0.02 pF.
- Capacitance is measured at 1 MHz.
- The total capacitance and capacitance ratios shown are for diodes housed in case style 30. Other case styles will result in different values.
- When ordering MA46H202-134 as whole wafer P/N is MAVR-0046202-0134WR.

Typical Performance Curves

0.75 Gamma Hyperabrupt

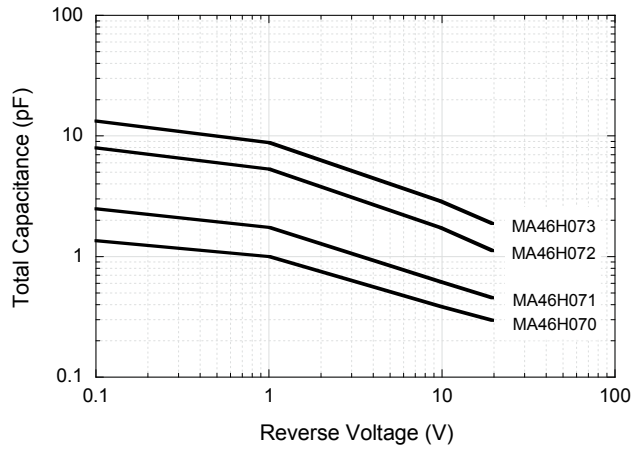

1.25 Gamma Abrupt

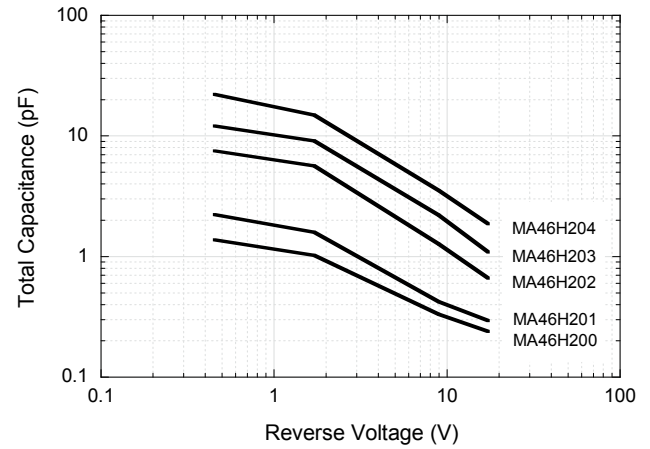

1.5 Gamma Hyperabrupt

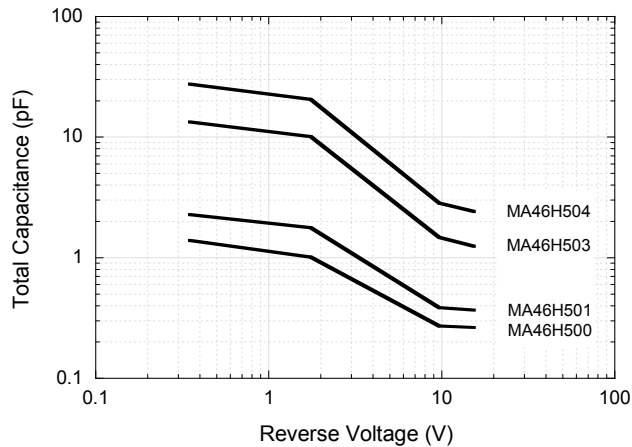

Temperature Coefficient of Capacitance in PPM/°C vs. Reverse Voltage

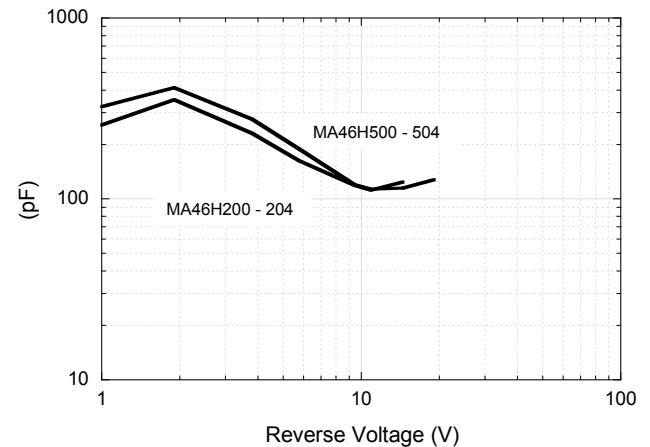
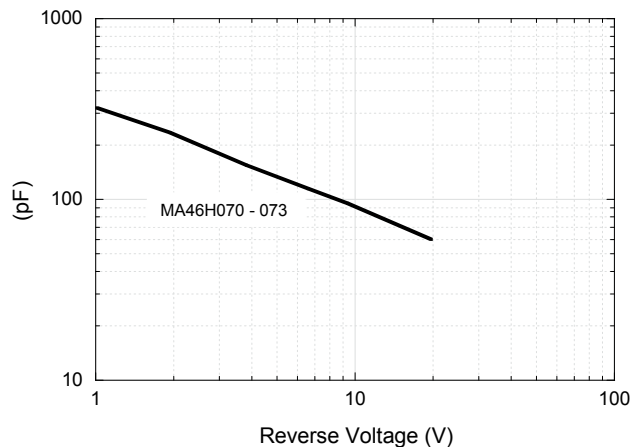

Case Styles

ODS-1056

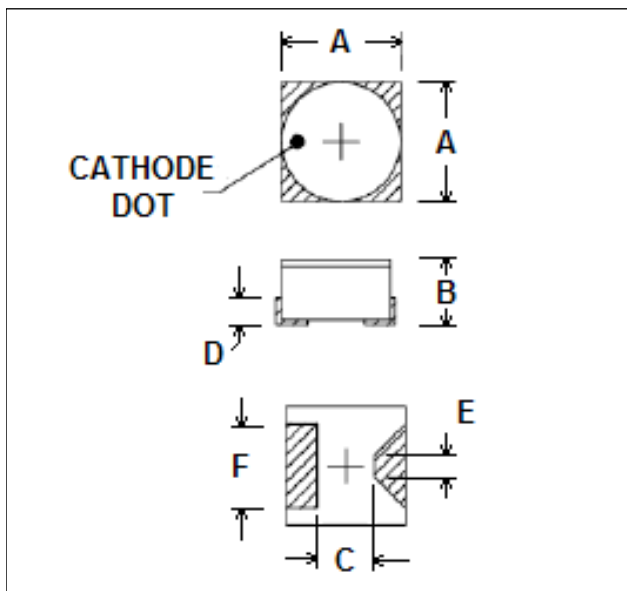

DIM.	INCHES		MILLIMETERS	
	MIN.	MAX.	MIN.	MAX.
A	0.065	0.075	1.65	1.91
B	0.034	0.041	0.86	1.04
C	0.030	0.036	0.76	0.91
D	0.009	0.021	0.23	0.53
E	0.010	0.014	0.25	0.36
F	0.043	0.053	1.09	1.35

Package Capacitance: 0.15 pF Typical
Package Inductance: 0.45 nH Typical

ODS-1088

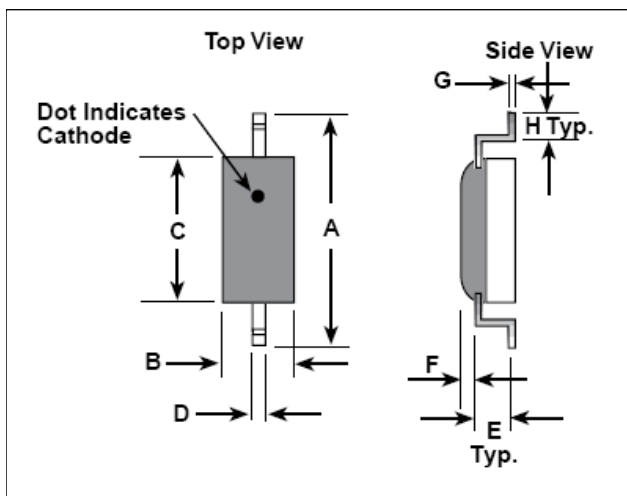

DIM.	INCHES		MILLIMETERS	
	MIN.	MAX.	MIN.	MAX.
A	0.175	0.195	4.44	4.95
B	0.040	0.050	1.02	1.27
C	0.085	0.095	2.16	2.41
D	0.015	0.025	0.38	0.64
E	0.010	0.015	0.25	0.38
F	0.015	0.020	0.38	0.51
G	0.004	0.006	0.10	0.15
H	0.020	0.030	0.51	0.76
J	0.013	0.033	0.33	0.84
K	0.003	0.005	0.08	0.13

Ordering Information

These GaAs tuning varactors are available in either case style as shown. When ordering, specify the desired case style by adding the case designation as a suffix to the model number. For example, a MA46H200-1088 specifies a 1.25 gamma hyperabrupt tuning diode in case style 1088.