

Specification

Part No.	:	MA510.C.W.CG.002
Product Name	:	Heavy Duty White Screw Mount Antenna MIMO Dual Band 2.4/5.8GHz
Features	:	2.4GHz/5.8GHz suitable for ISM Bands/ZigBee/WLAN/Bluetooth IEEE.802.11n/IEEE.802.11ac High Isolation between Antenna Elements Vandal resistant PC housing IP65 Rated Enclosure Height 29mm Diameter 49mm RoHS & REACH Compliant



1. Introduction

The MIMO communication system has been one of the most promising technologies, well suited for high data rate communication. A MIMO (Multiple-Input-Multiple-Output) system use at least two antenna structures and is more advantageous than single-input single-output (SISO) in an aspect of increasing channel capacity and reducing transmitting power. MIMO antennas should have compact structure, high radiation efficiency, low envelope correlation, and high isolation between the signal ports.

In small structures (antennas spaced closely), the application of MIMO technology has been restricted by high degree of coupling and spatial correlation between antenna elements due to the limited available space. The isolation between antennas become critical as it can deteriorate the system performance and decreases channel capacity.

The Hercules MA510 MIMO antenna is low profile, heavy-duty, fully IP65 waterproof external M2M antenna for use, transportation and remote monitoring applications. This unique omnidirectional antenna provides high efficiency and high isolation between antennas elements in a heavy-duty low profile compact structure, delivering powerful MIMO antenna technology for Wi-Fi 802.11n and emerging 802.11ac.

The antenna screws down permanently onto a roof or metal panel and can be pole or wall-mounted. The two antenna elements are vertically polarized.

For industries such as remote monitoring, smart meter systems, construction equipment, public safety at only 29mm high, the Hercules MA510 MIMO antenna provides an unobtrusive, robust, rugged antenna that is durable even in extreme environments.

Also available in black.

2. Specification

Antenna Hercules MA510 MIMO		
ELECTRICAL		
Operation Frequency (GHz)	2.4~2.5	4.8~5.8
Polarization	Linear	Linear
Impedance (ohms)	50	50
Min Isolation (dB)	-22	-28
Max VSWR	2.0:1	2.0:1
Max Return Loss (dB)	-10	-10
Peak Gain (dBi)	4.2	4.0
Efficiency (%)	60	40
Average Gain (dB)	-2.2	-3.9
Radiation Properties	Omni	Omni
Max Input Power	2W max	
MECHANICAL		
Dimensions (mm)	Height=29 Diameter=49	
Cable	1m RG316- Fully Customizable	
Casing	PC	
Base and Thread	Nickel Plated Zinc Alloy	
Weather proof gasket	CR4305 foam with 3M9448B double-side adhesive	
Connector	RP-SMA Male Fully Customizable	
Thread Diameter (mm)	18	
Sealant	Rubber Stopper	
Recommended Torque for Mounting	24.5N·m	
Max Torque for Mounting	29.4N·m	
Weight	134g	
ENVIRONMENTAL		
Corrosion	5% NACI for 48hrs- Nickel plated zinc alloy base and thread	
Temperature Range	-40°C to +85°C	
Thermal Shock	100 cycles -40°C to +85°C	
Humidity	Non-condensing 65°C 95% RH	
Shock (Drop Test)	1m drop on concrete 6 axes	
Ingress Protection	IP65	

* The Hercules MA510 MIMO antenna performance was measured with RG316 coaxial cable at 1 meter cable length on a 30x30 cm ground plane.

3. Antenna Characteristics

3.1 Test set-up



Figure 1. Impedance measurements.

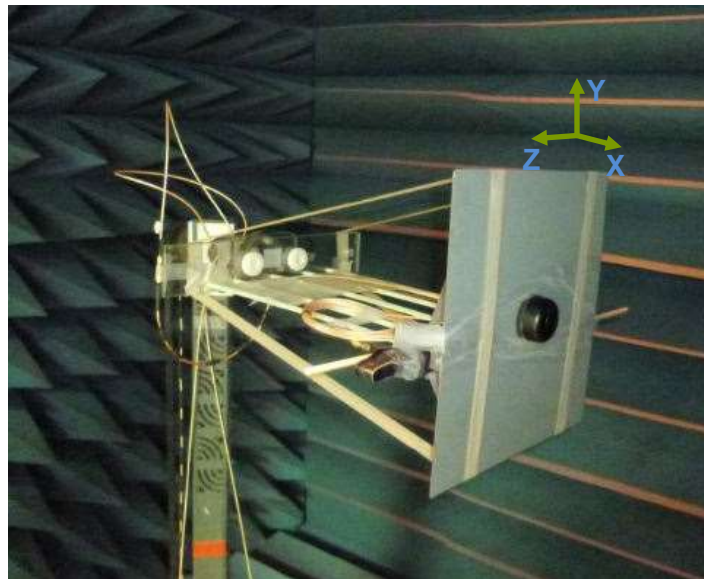

Figure 2. Peak gain, efficiency and radiation pattern measurements.

3.2 Return Loss

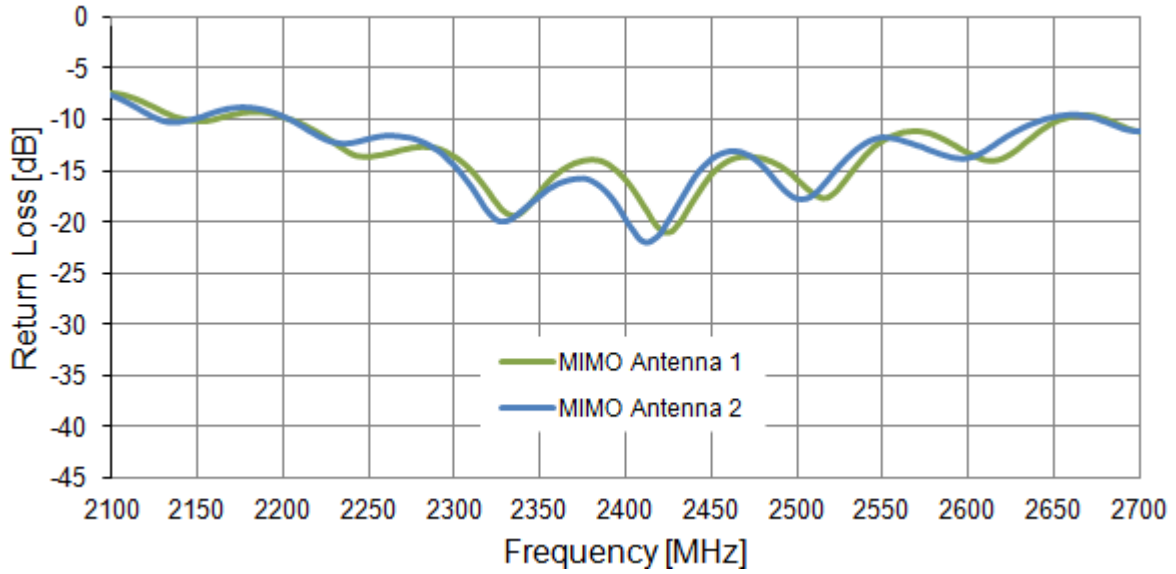

Figure 3. Return loss of the Hercules MA510 MIMO antenna from 2100 MHz to 2700 MHz.

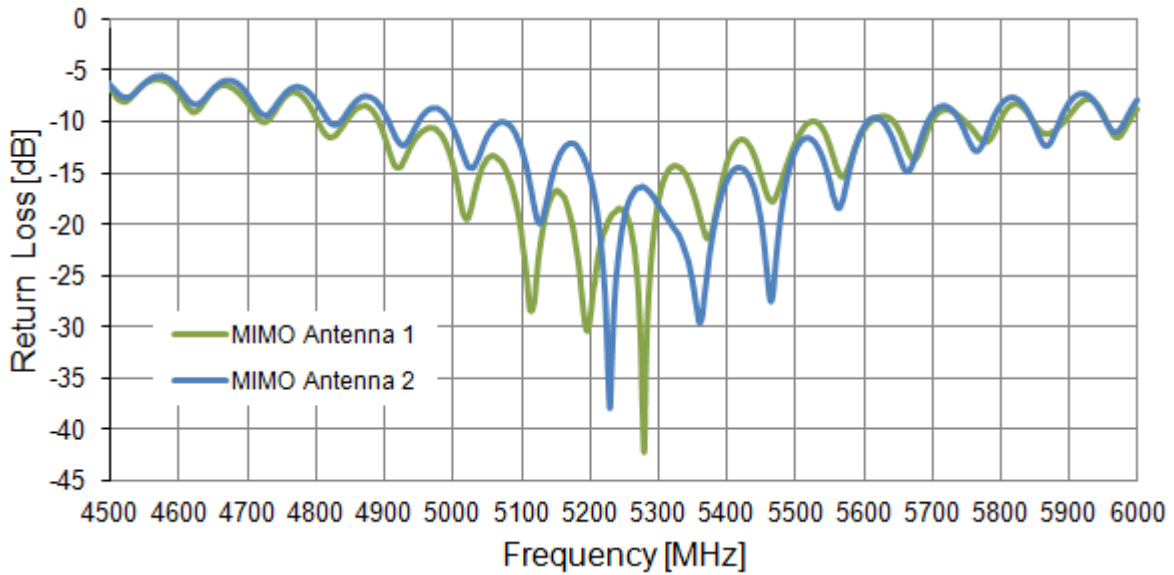

Figure 4. Return loss of the Hercules MA510 MIMO antenna from 4500 MHz to 6000 MHz.

3.3 VSWR

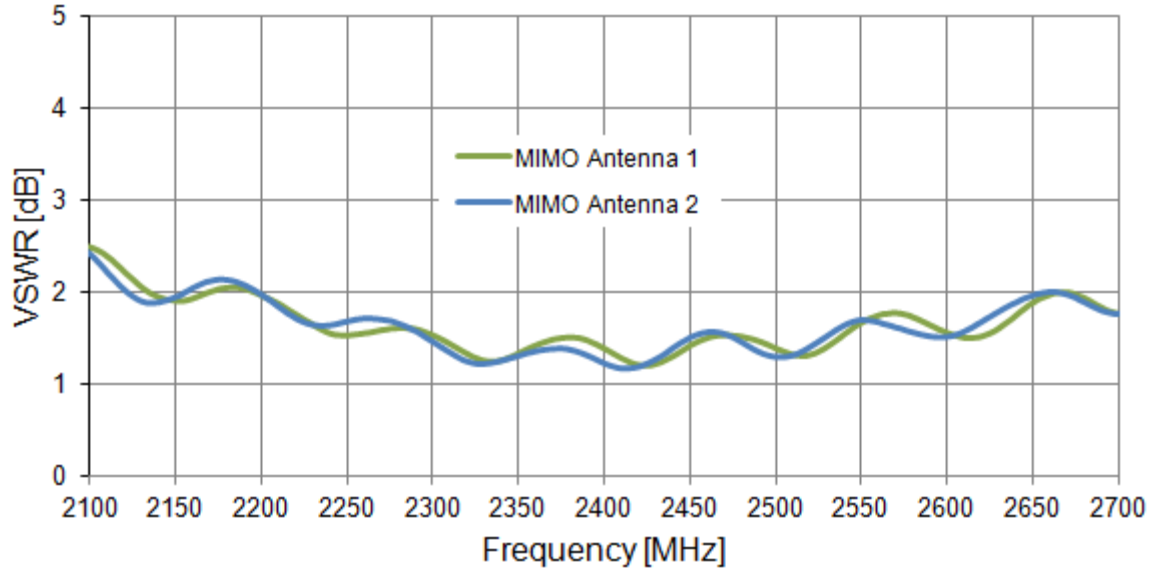

Figure 5. VSWR of the Hercules MA510 MIMO antenna from 2100 MHz to 2700 MHz.

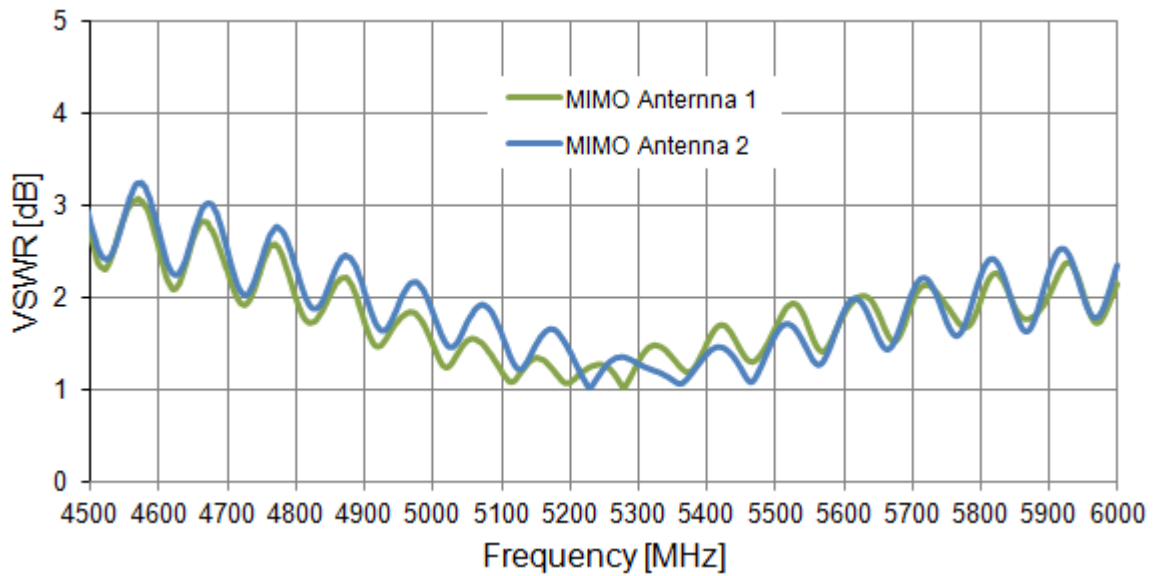

Figure 6. VSWR of the Hercules MA510 MIMO antenna from 4500 MHz to 6000 MHz

3.4 Isolation

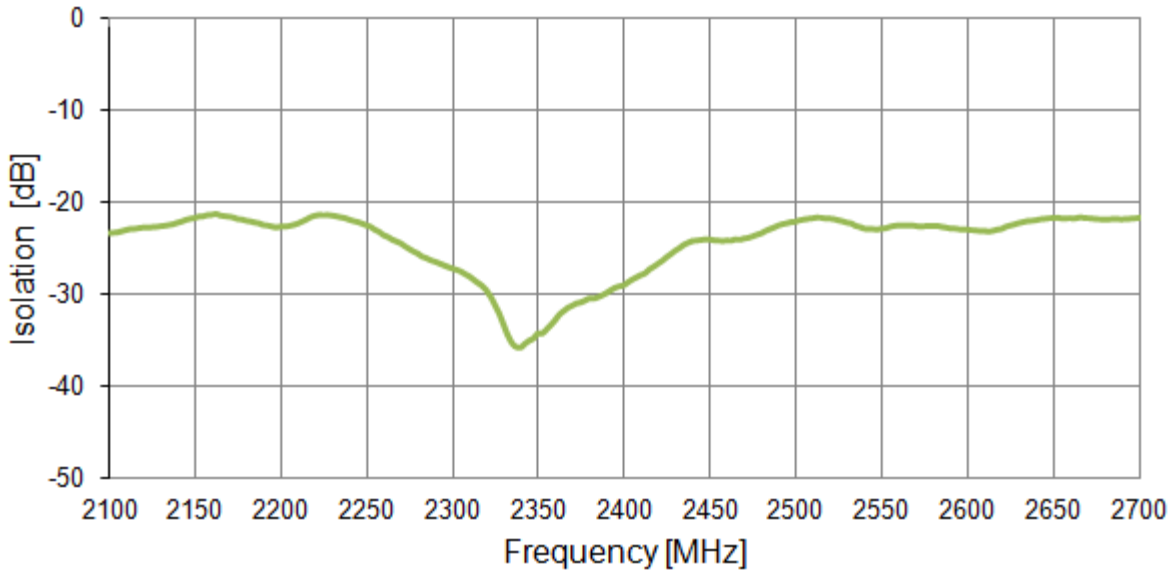

Figure 7. Isolation of the Hercules MA510 MIMO antenna from 2100 MHz to 2700 MHz

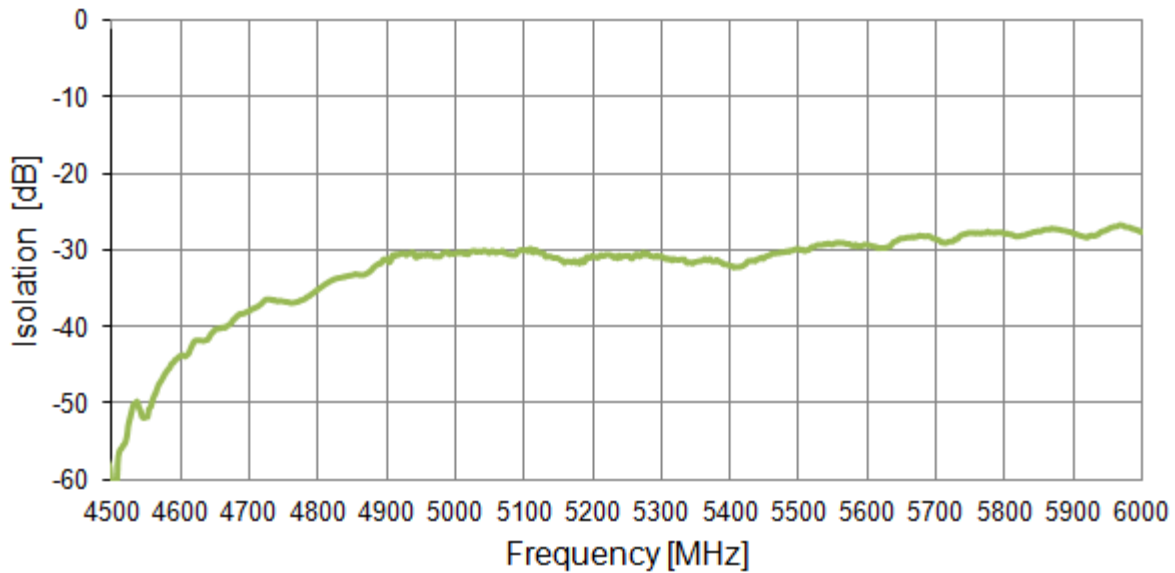

Figure 8. Isolation of the Hercules MA510 MIMO antenna from 4500 MHz to 6000 MHz

3.5 Envelope Correlation Coefficient (ECC)

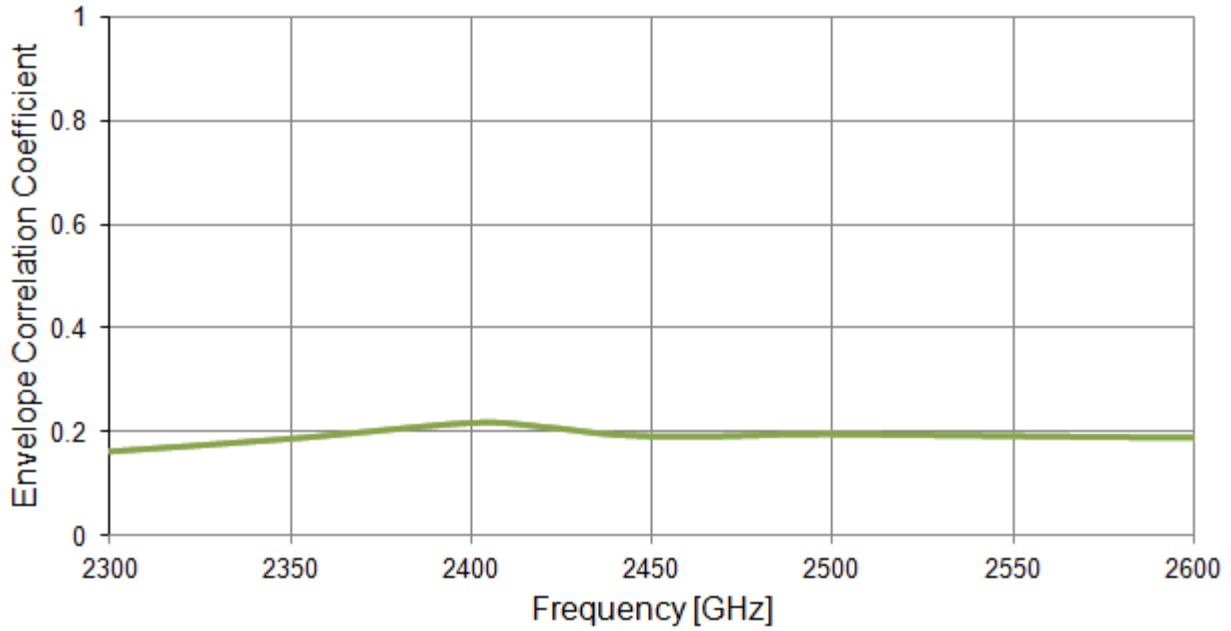

Figure 9. ECC of the Hercules MA510 MIMO antenna from 2300 MHz to 2600 MHz.

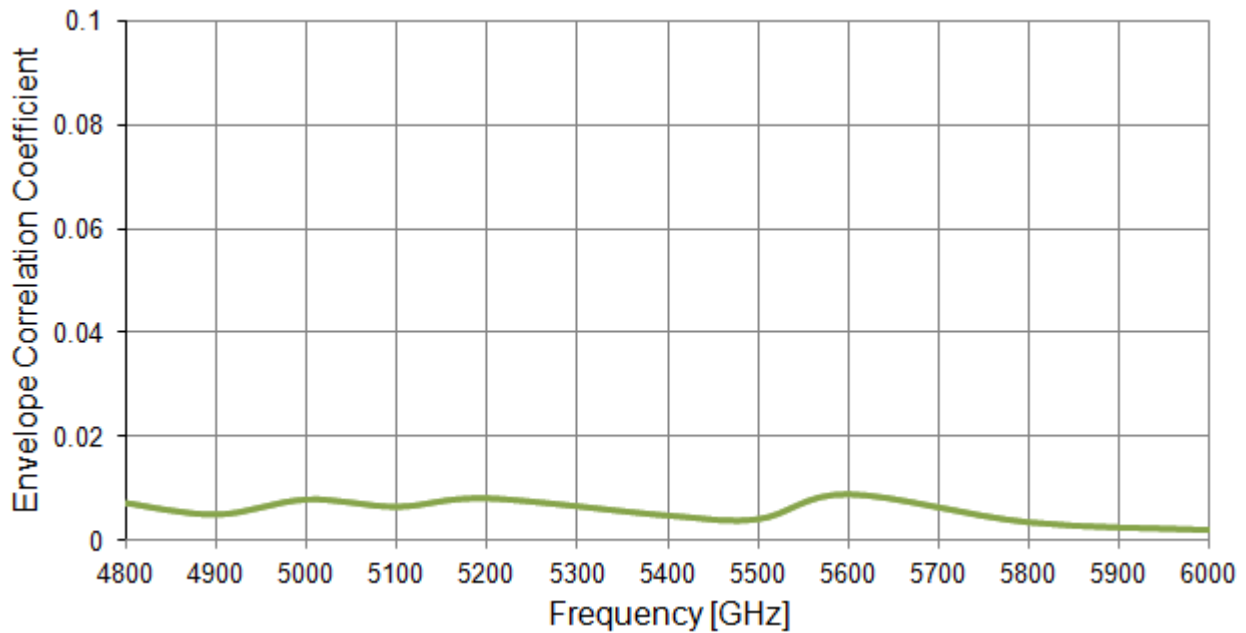

Figure 10. ECC of the Hercules MA510 MIMO antenna from 4800 MHz to 6000 MHz.

3.6 Efficiency

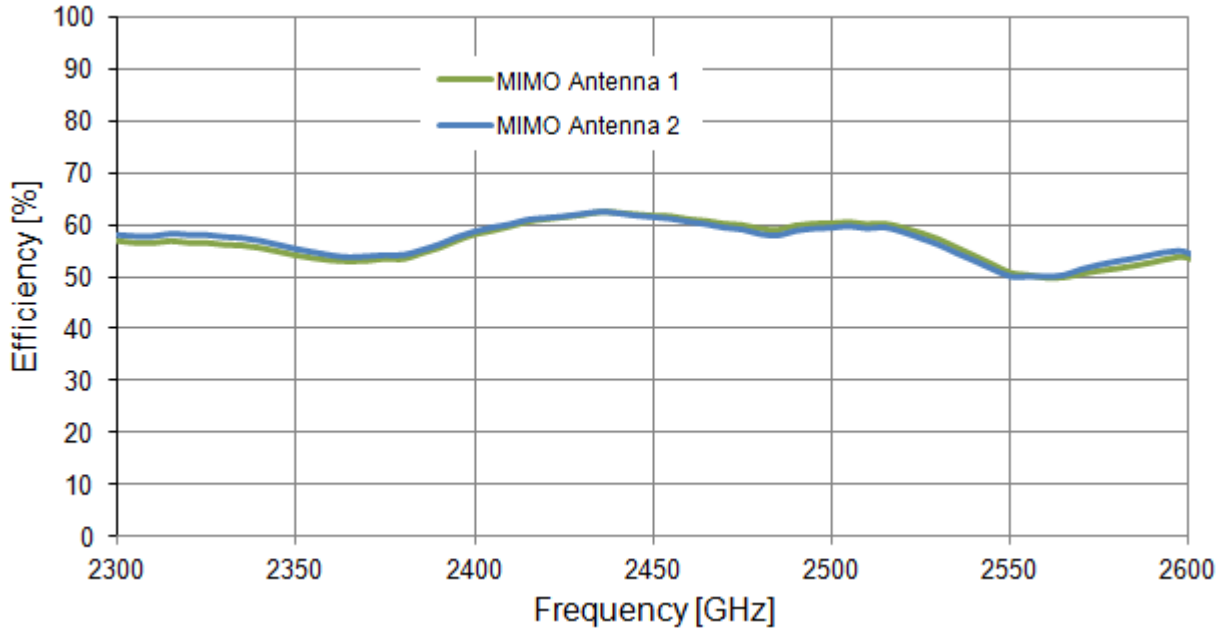

Figure 11. Efficiency of the Hercules MA510 MIMO antenna from 2300 MHz to 2600 MHz.

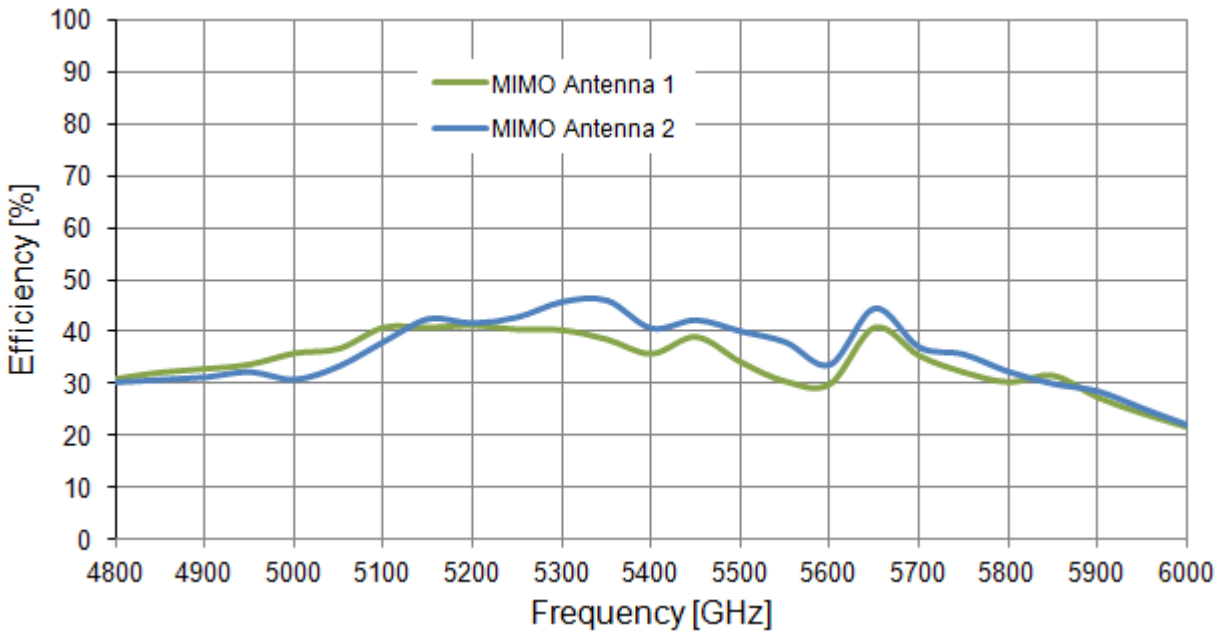

Figure 12. Efficiency of the Hercules MA510 MIMO antenna from 4800 MHz to 6000 MHz.

3.7 Peak Gain

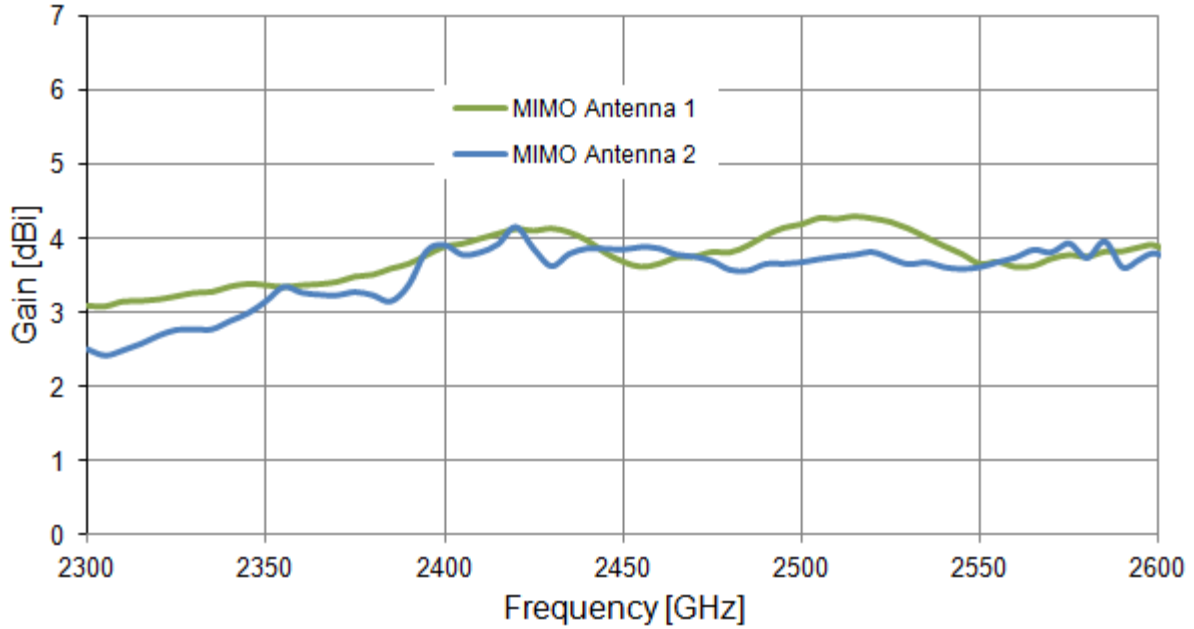

Figure 13. Peak Gain of the Hercules MA510 MIMO antenna from 2300 MHz to 2600 MHz.

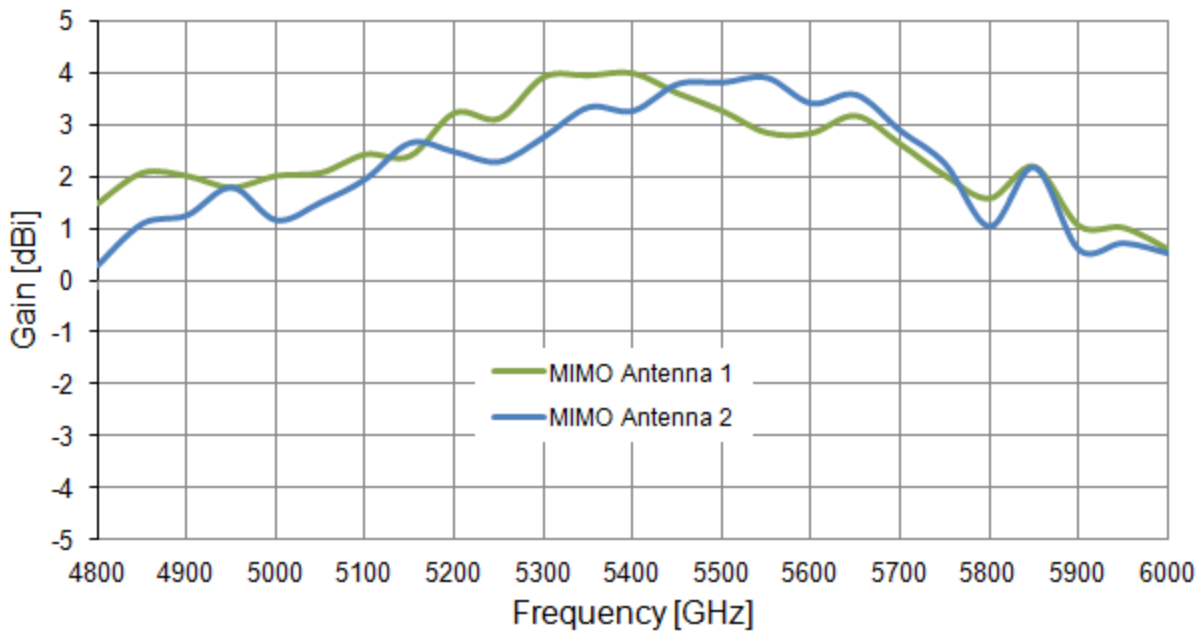

Figure 14. Peak Gain of the Hercules MA510 MIMO antenna from 4800 MHz to 6000 MHz.

3.8 Average Gain

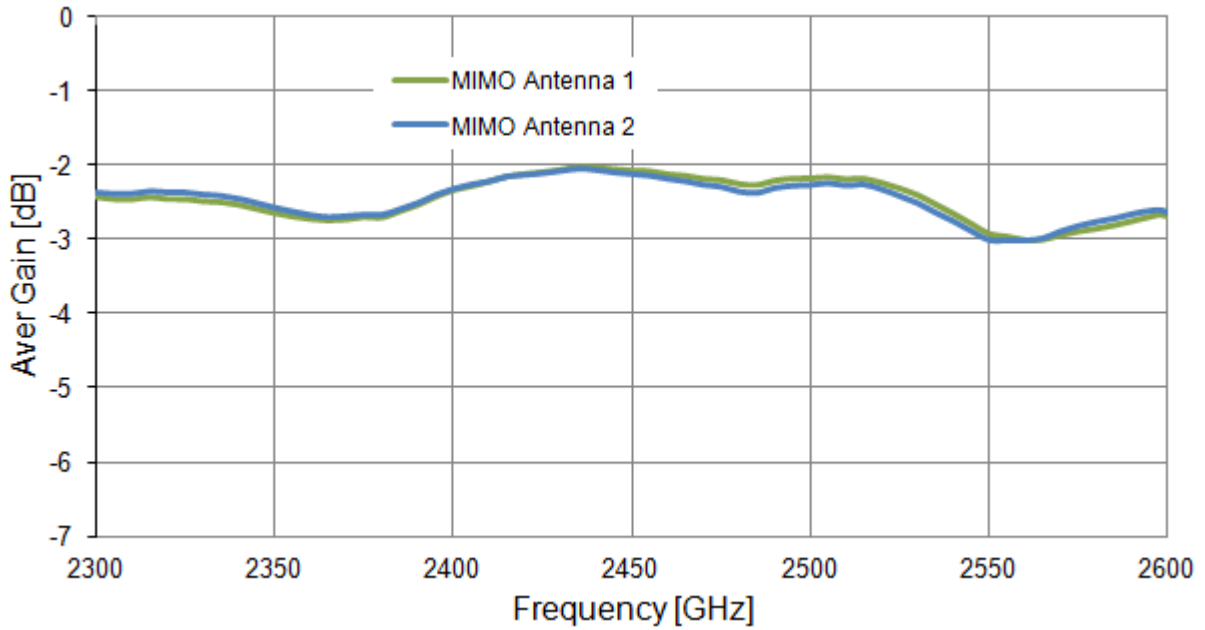

Figure 15. Average Gain of the Hercules MA510 MIMO antenna from 2300 MHz to 2600 MHz.

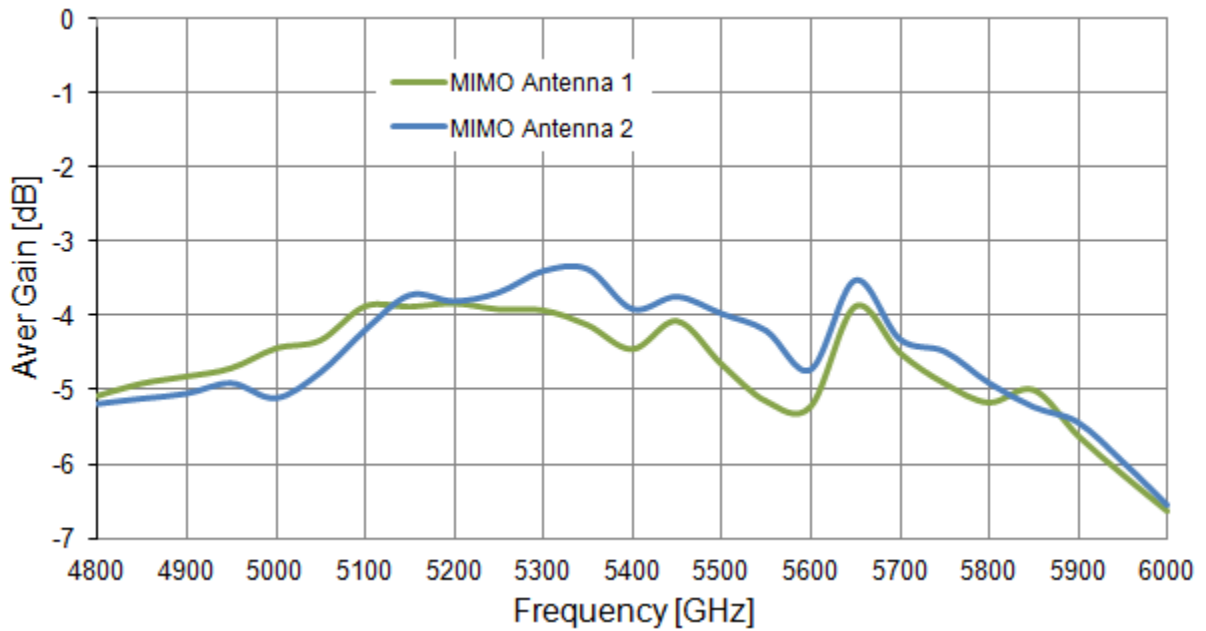

Figure 16. Average Gain of the Hercules MA510 MIMO antenna from 4800 MHz to 6000 MHz.

3.9 3D Radiation Patterns

3.9.1 MIMO Antenna 1

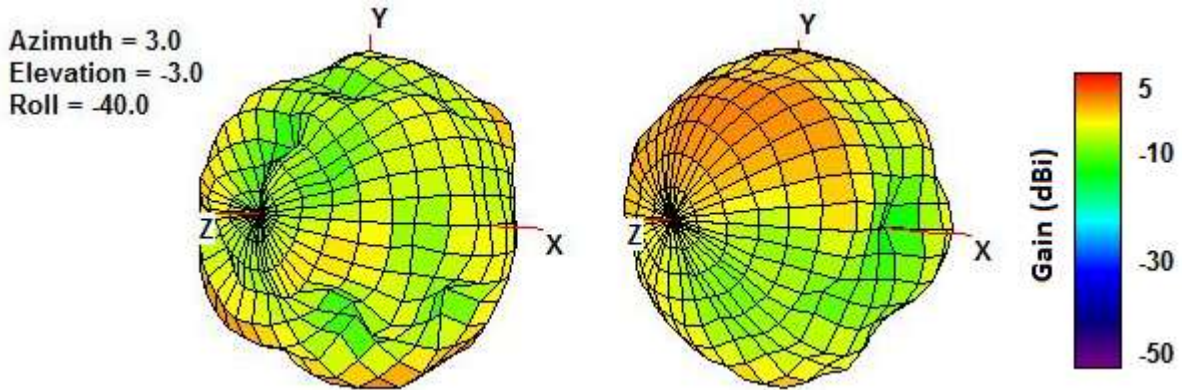

Figure 17. 3D Radiation Pattern at 2450 MHz (left side), Radiation Pattern at 5400 MHz (right side) of the MA510 Antenna.

3.9.2 MIMO Antenna 2

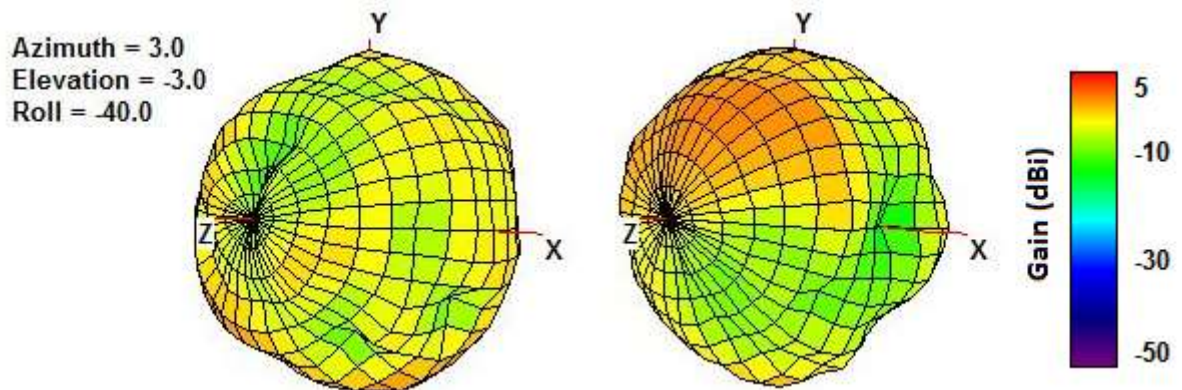
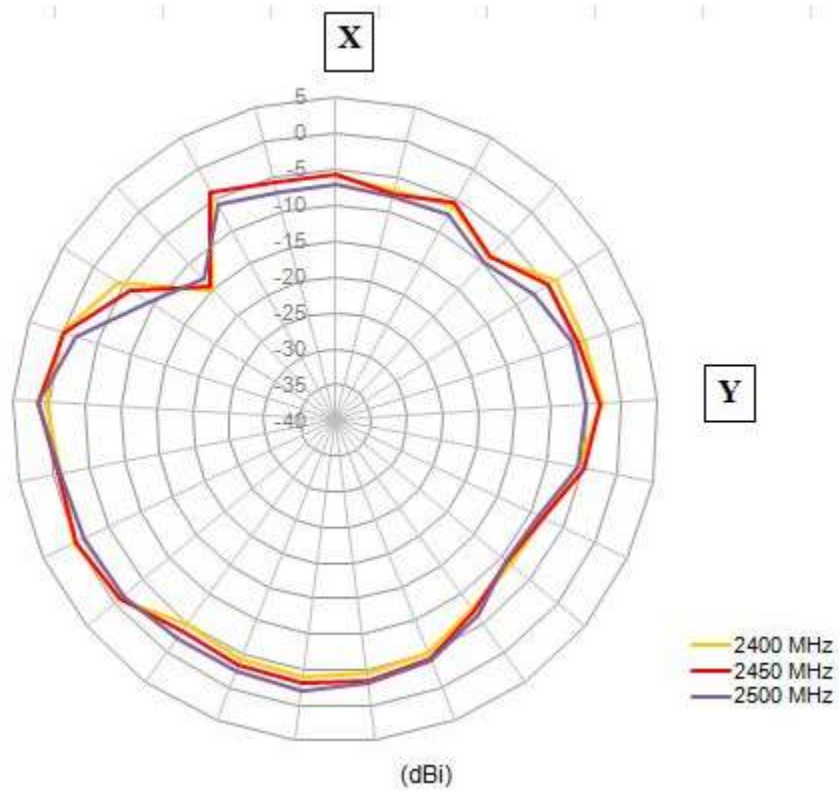

Figure 18. 3D Radiation Pattern at 2450 MHz (left side), Radiation Pattern at 5400 MHz (right side) of the MA510 Antenna

3.10 2D Radiation Patterns

3.10.1 MIMO Antenna 1 2400 MHz Band



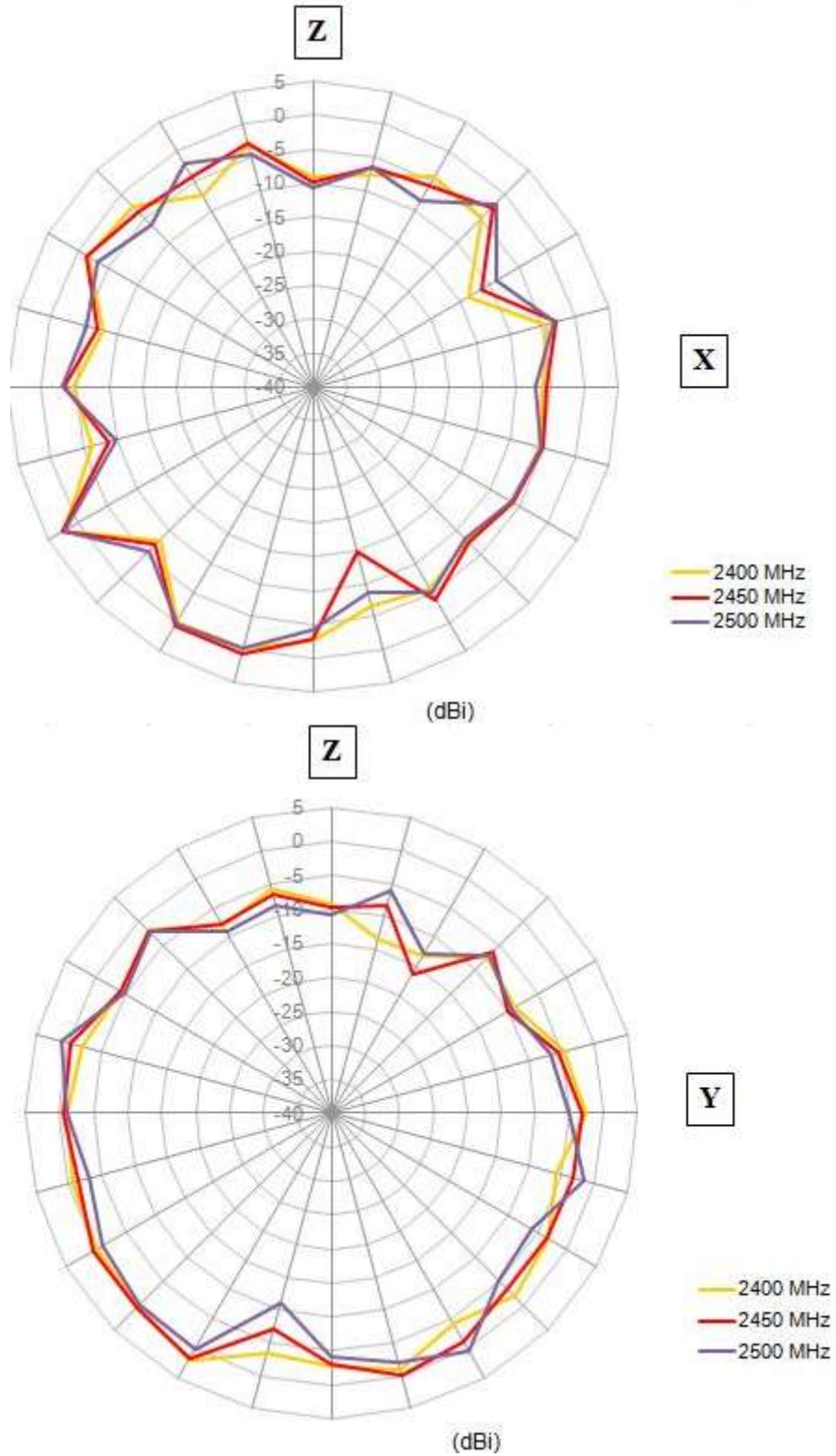
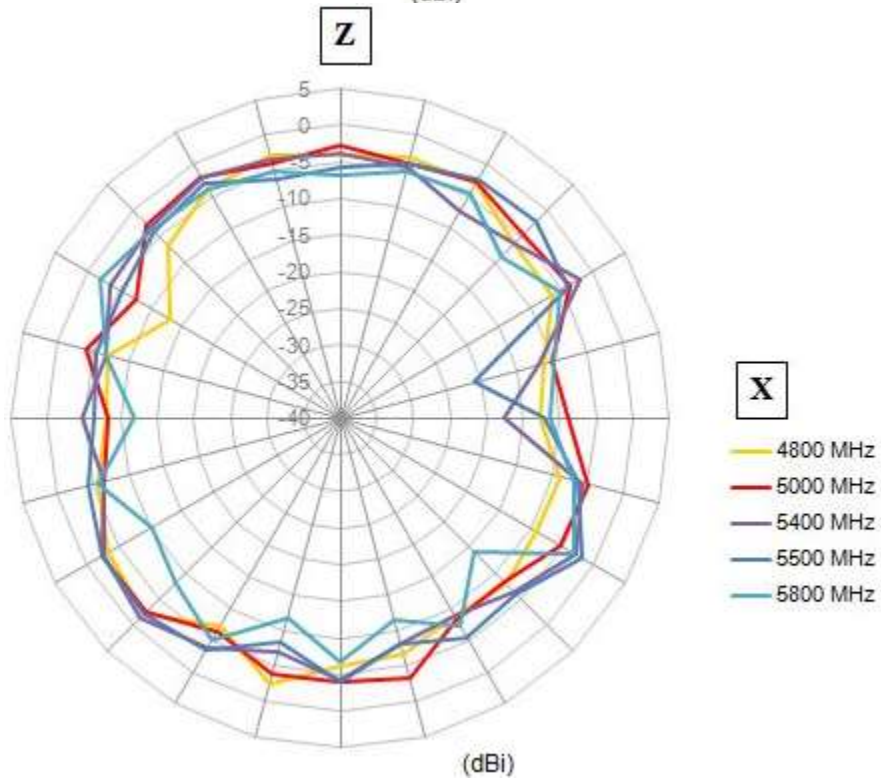
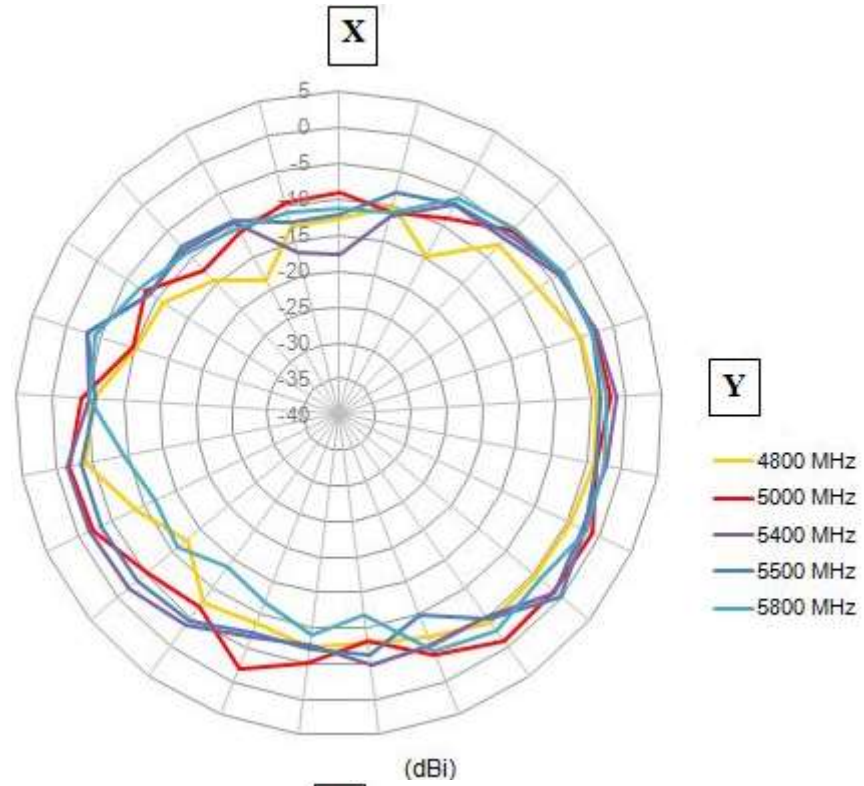

Figure 19. 2D Radiation Pattern at 2400MHz band

3.10.2 MIMO Antenna 1 5800 MHz Band



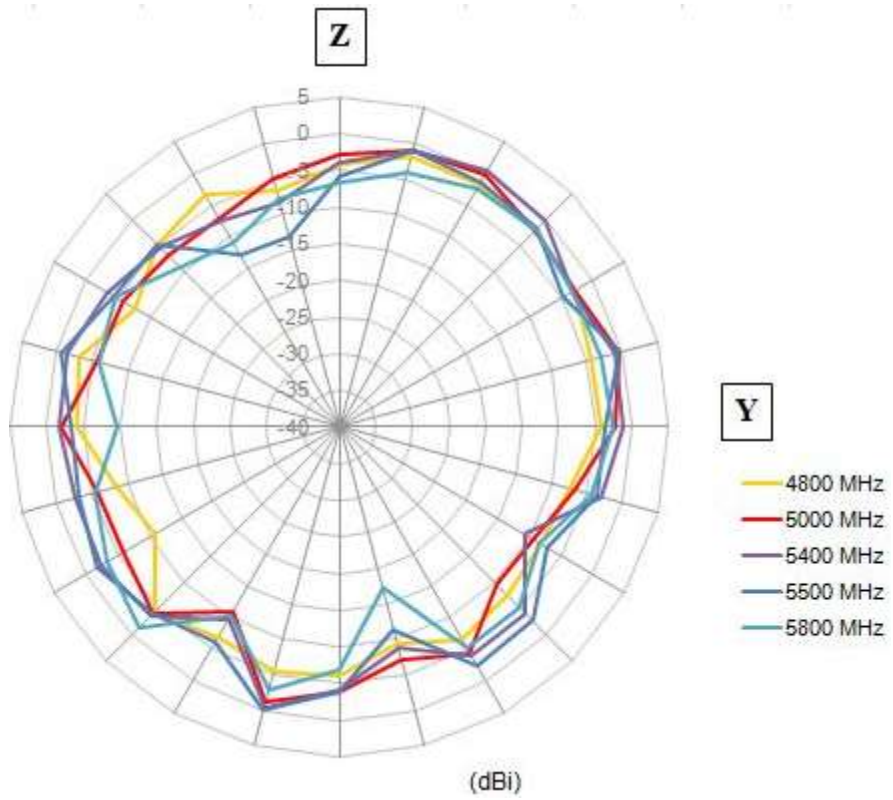
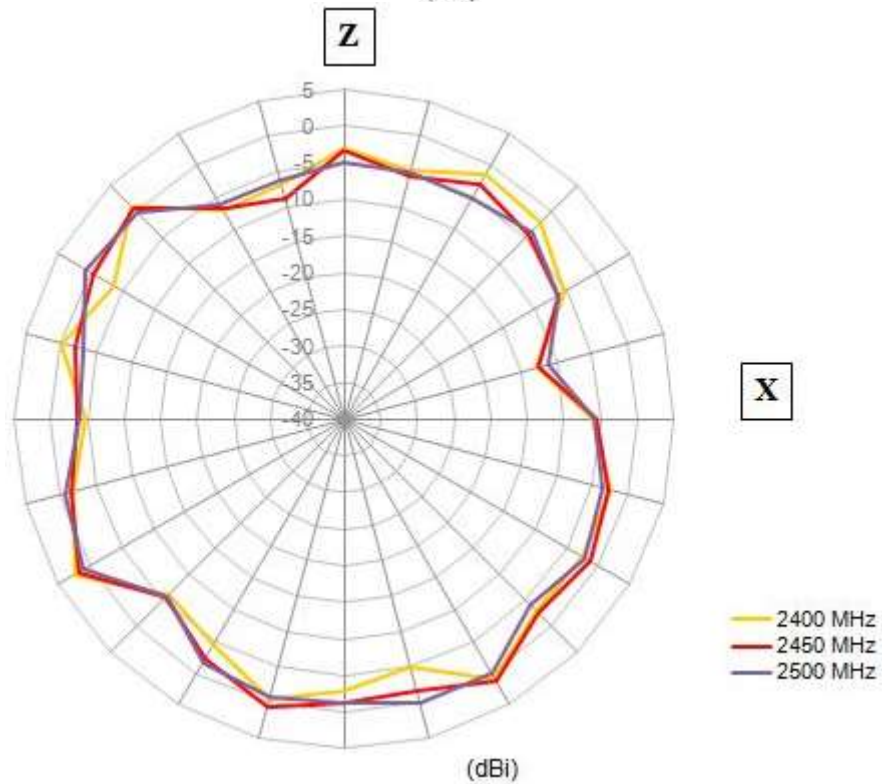
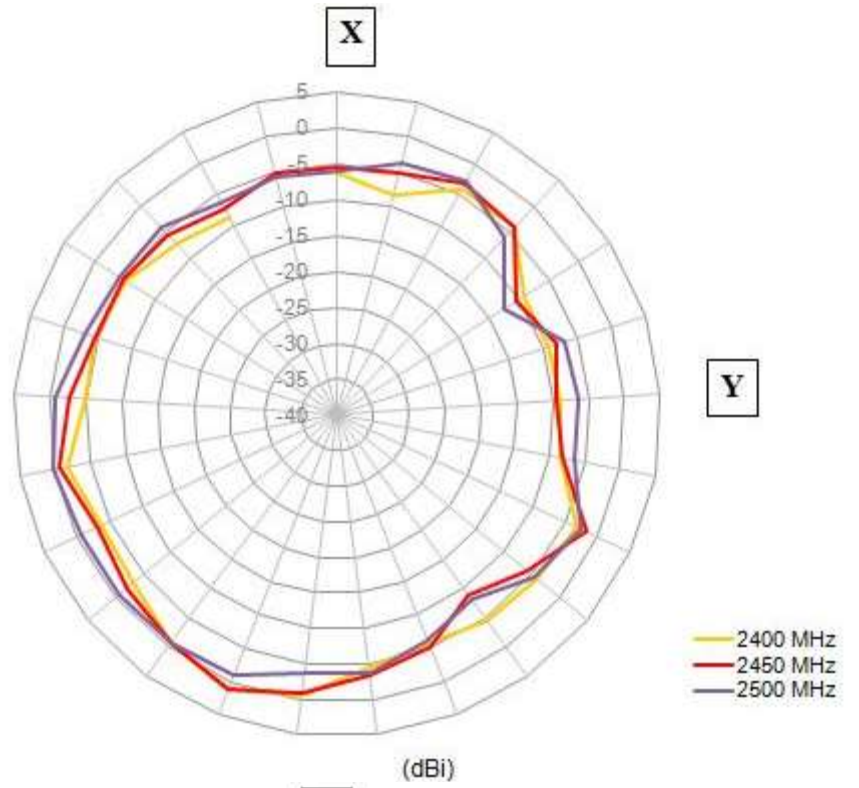

Figure 20. 2D Radiation Pattern at 5800MHz band

3.10.3 MIMO Antenna 2 2400 MHz Band



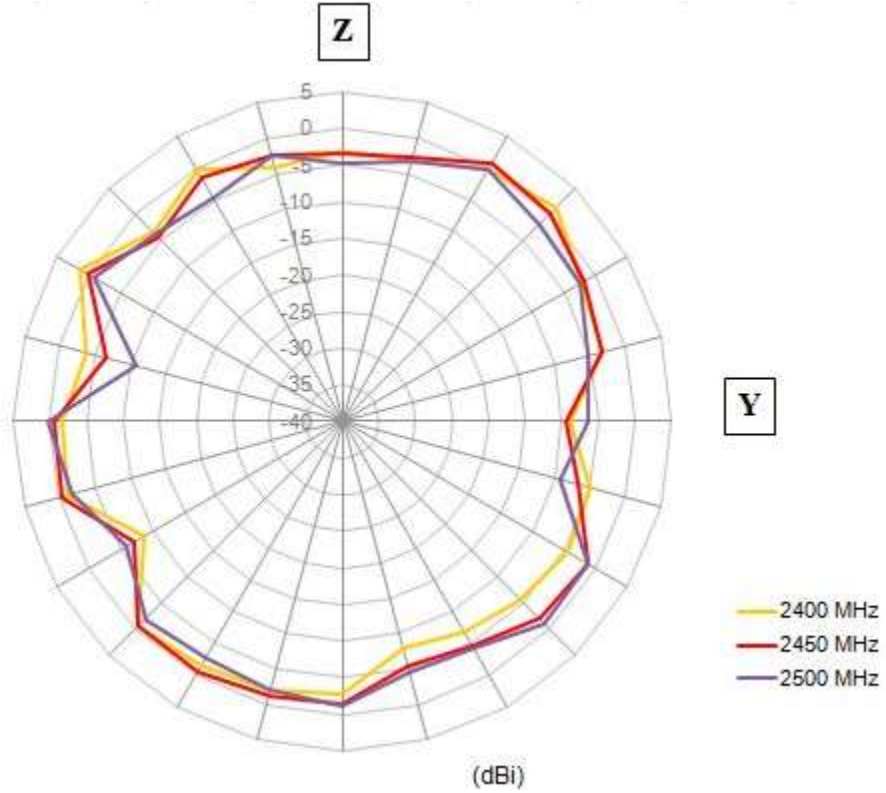
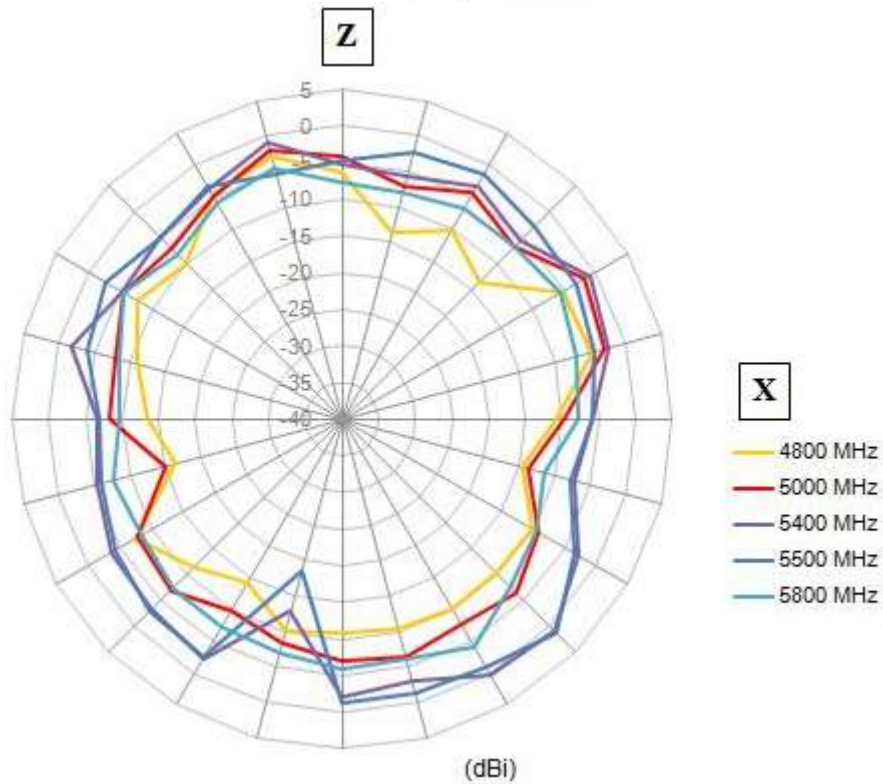
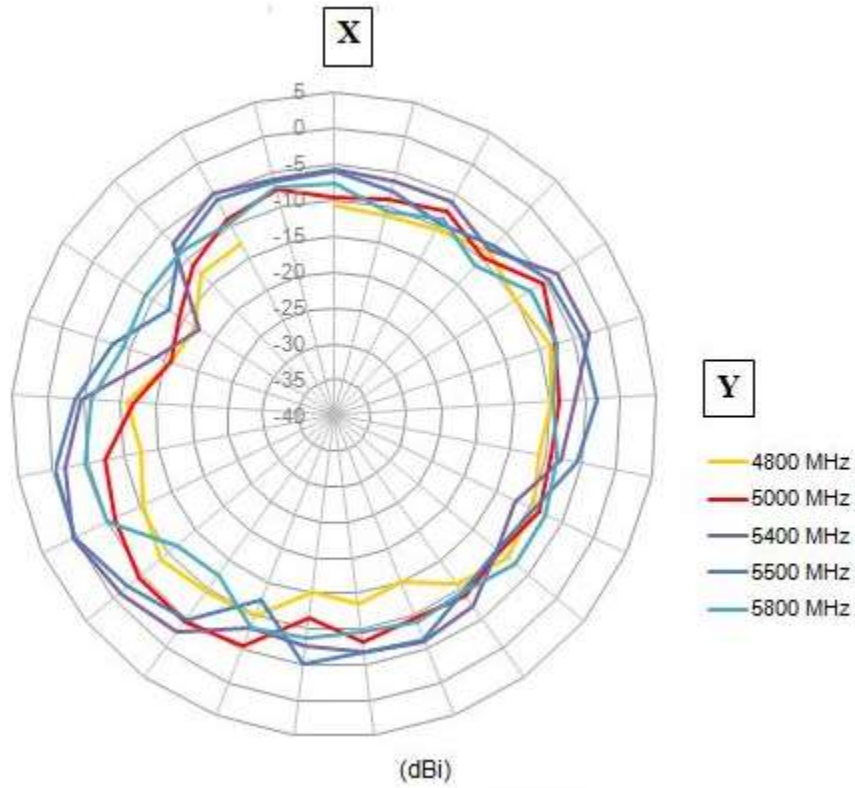

Figure 21. 2D Radiation Pattern at 2400MHz band

3.10.4 MIMO Antenna 2 5800 MHz Band



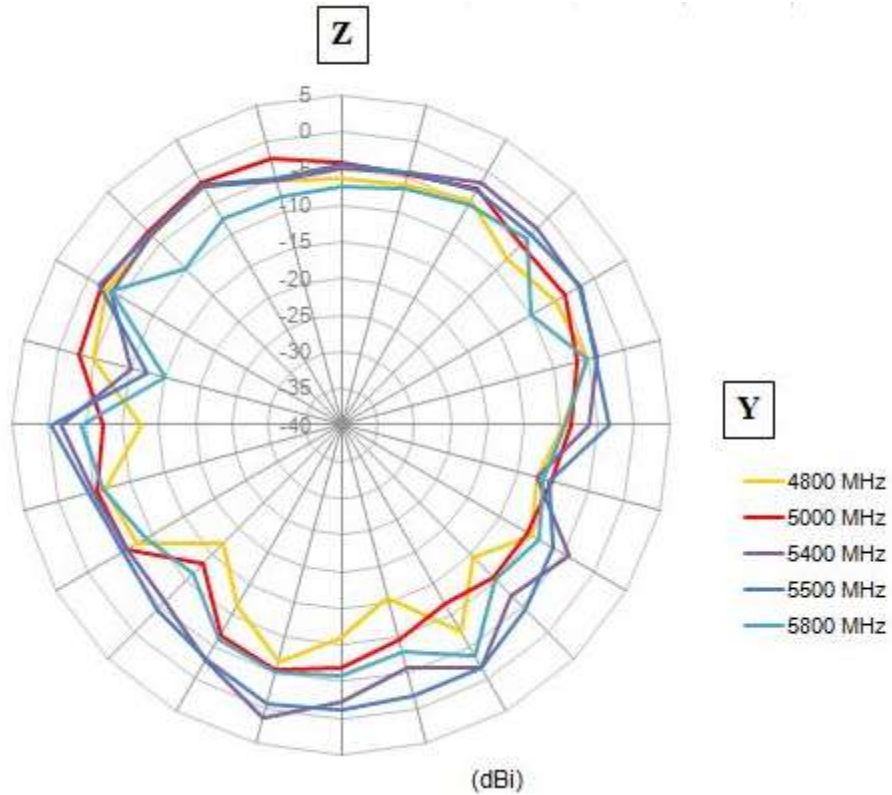
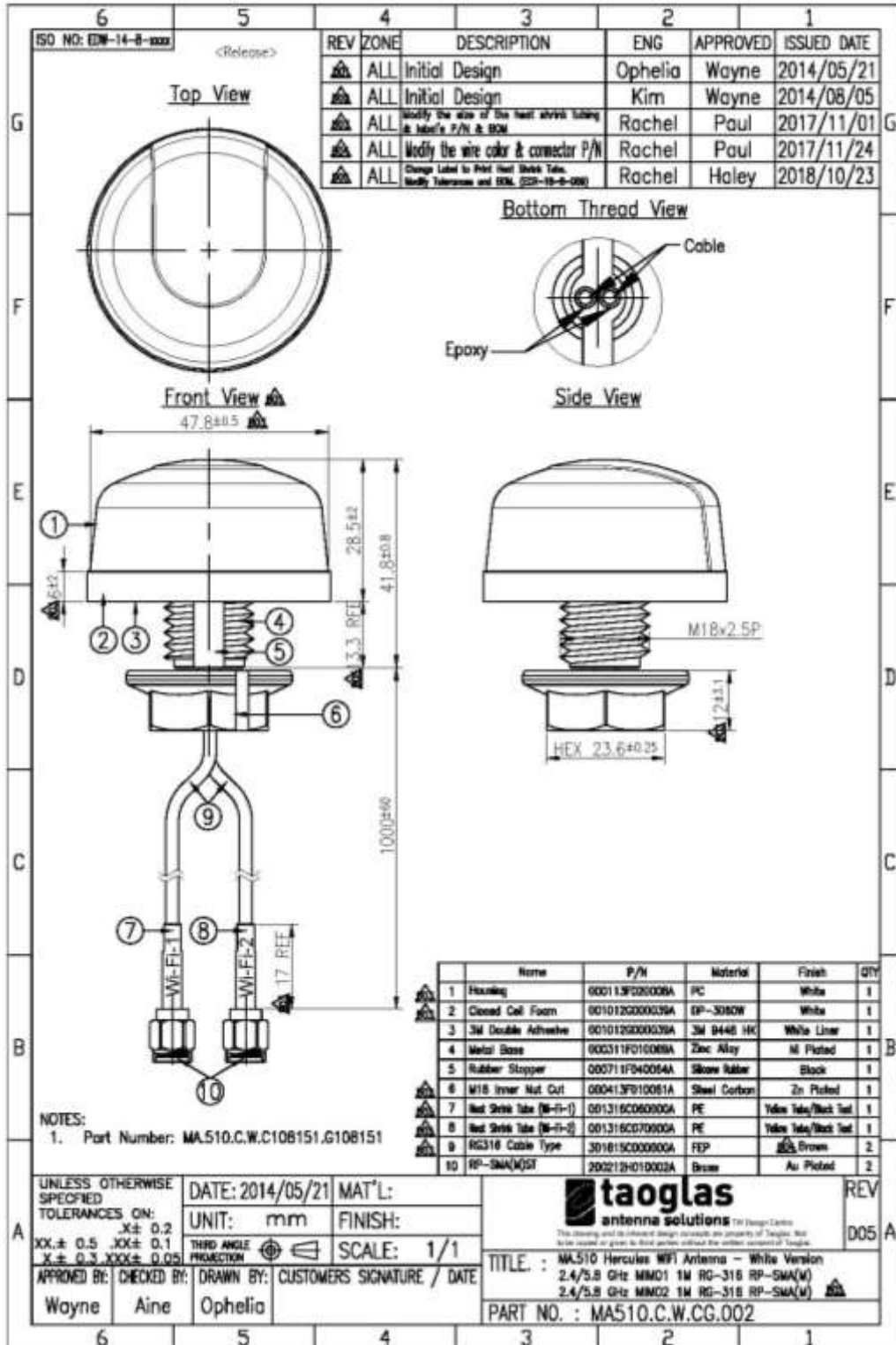

Figure 22. 2D Radiation Pattern at 5800MHz band



TAOGLAS

4. Antenna Drawing (unit: mm)



5. Installation

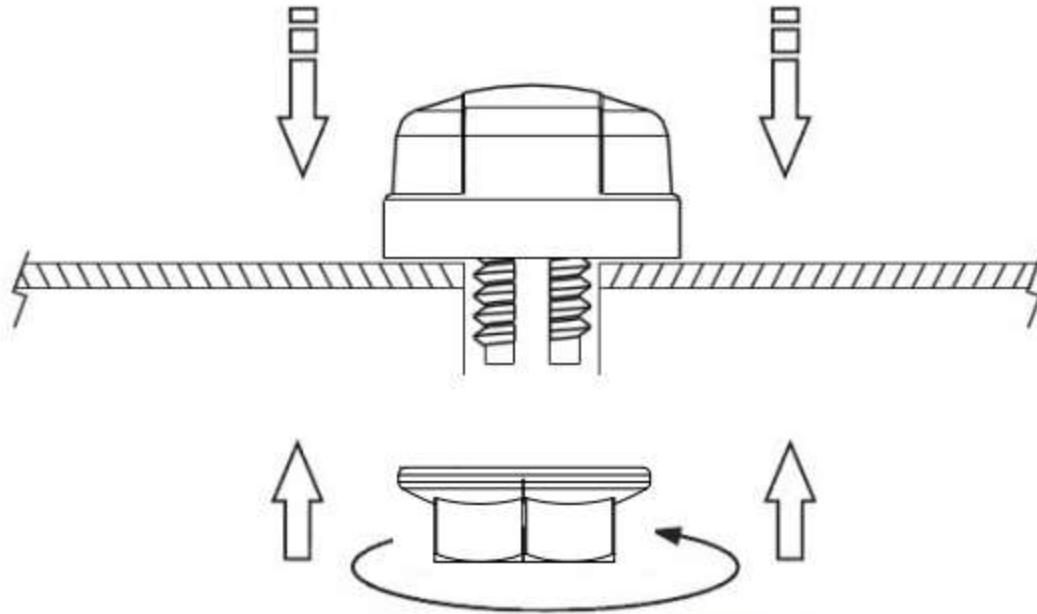

Recommended torque for Mounting is 24.5N·m
Maximum torque for mounting is 29.4N·m

Figure 23. Installation



TAOGLAS

6. Packaging

1pcs antenna per big PE bag

40 big PE bag per box

