



TAOGLAS®



Datasheet

Guardian 2 in 1 Adhesive Mount Antenna

Part No:
MA912.A.BI.001

Description:
Guardian 2in1 Adhesive Mount Antenna 2*LTE MIMO

Features:

- Low-profile Housing
- Mount on Wall or Glass
- 2* 4G/LTE MIMO 698-4000MHz
- Worldwide 4G Bands including fallback to 3G and 2G
- IP67 Waterproof Enclosure
- Dimension: 146*134*20mm
- Cables: 3m Low Loss TGC-200 and RG174
- Connectors: SMA(M)/RP-SMA(M)
- Cables and Connectors Customizable
- RoHS & REACH Compliant

1.	Introduction	3
2.	Specifications	4
3.	Antenna Characteristics	10
4.	Mechanical Drawing	61
6.	Packaging	62
7	Application Note	64
	Changelog	90

Taoglas makes no warranties based on the accuracy or completeness of the contents of this document and reserves the right to make changes to specifications and product descriptions at any time without notice. Taoglas reserves all rights to this document and the information contained herein.

Reproduction, use or disclosure to third parties without express permission is strictly prohibited.



1. Introduction



The MA912 Guardian is a new generation of combination antenna. It is the first panel antenna worldwide designed for IoT gateway and router devices. It is a low profile 2 in 1 wall and adhesive mount antenna. It is a heavy-duty, fully IP67 waterproof resistant external M2M antenna for use by RF professionals in:

- IoT Gateway and Routers
- HD Video Streaming
- Transportation
- Remote monitoring applications

This antenna delivers powerful MIMO antenna technology for worldwide 4G LTE bands at 698-4000MHz bands and dual 2.4/5.8GHz Wi-Fi. It enables designers to cover a wide range of technologies by installing a single antenna.

4G wireless applications demand high speed data uplink and downlink. High efficiency and high gain MIMO antennas are necessary to achieve the required signal to noise ratio and throughput required to solve these challenges. Taoglas also takes care to have high isolation among these antennas to prevent self-interference. Low loss cables used to keep efficiency high over long cable lengths.

The housing is made of durable ASA, is IP67 waterproof and comes with a 3M foam adhesive. The antenna can be mounted internally or externally on a vehicle or building. The MA912 comes with 3 meters TGC-200 cable as standard. Customized cables and connector versions are also available. Contact your regional Taoglas customer support for more information on how to integrate the MA912 or sales support.

2. Specifications

4G/3G/2G MIMO1 Antenna									
Frequency (MHz)		LTE700	GSM850	GSM900	DCS	PCS	UMTS1	LTE2600	LTE3500
		698~803	824~894	880~960	1710~1880	1850~1990	1920~2170	2490~2690	3300~3600
Efficiency (%)									
MIMO_1	Free space	43.92	47.52	34.92	52.65	54.62	55.40	36.80	36.43
	ABS	59.01	59.23	51.81	52.53	55.15	54.24	37.85	37.13
	Glass	58.74	57.34	53.23	52.99	55.87	53.91	38.14	37.82
	Metal	36.32	43.87	49.29	31.28	36.73	36.97	33.19	32.08
	Wall	58.74	59.92	56.46	50.65	50.54	49.08	37.66	36.87
MIMO_2	Free space	46.78	50.19	41.11	48.77	53.15	52.96	40.86	37.57
	ABS	62.00	56.24	49.57	50.06	53.93	53.64	40.37	39.32
	Glass	55.75	47.40	38.25	51.45	52.81	51.02	37.42	37.04
	Metal	48.01	53.73	47.86	25.45	31.81	34.06	40.56	37.87
	Wall	53.53	41.19	44.70	45.98	43.96	43.67	40.87	34.84
Average Gain (dB)									
MIMO_1	Free space	-3.60	-3.32	-4.57	-2.79	-2.63	-2.57	-4.38	-4.41
	ABS	-2.31	-2.29	-2.86	-2.80	-2.59	-2.66	-4.26	-4.32
	Glass	-2.36	-2.43	-2.75	-2.76	-2.53	-2.69	-4.23	-4.24
	Metal	-4.57	-3.58	-3.09	-5.08	-4.36	-4.34	-4.83	-4.96
	Wall	-2.33	-2.23	-2.49	-2.96	-2.96	-3.10	-4.26	-4.34
MIMO_2	Free space	-3.35	-3.02	-3.90	-3.12	-2.75	-2.77	-3.91	-4.28
	ABS	-2.10	-2.51	-3.06	-3.01	-2.68	-2.71	-3.97	-4.08
	Glass	-2.57	-3.26	-4.19	-2.89	-2.77	-2.93	-4.31	-4.32
	Metal	-3.24	-2.70	-3.22	-5.97	-4.98	-4.70	-3.94	-4.22
	Wall	-2.72	-3.85	-3.51	-3.38	-3.57	-3.61	-3.89	-4.60
Peak Gain (dBi)									
MIMO_1	Free space	2.48	2.90	1.44	2.98	3.27	3.27	2.40	2.99
	ABS	3.95	3.30	2.67	4.24	4.95	4.95	3.39	1.70
	Glass	3.01	3.22	3.65	4.20	5.06	6.57	4.14	2.37
	Metal	4.39	2.40	3.93	3.50	3.86	4.59	4.82	3.48
	Wall	4.04	4.27	2.97	4.44	3.74	3.74	3.88	2.25
MIMO_2	Free space	5.13	2.96	1.87	2.68	2.91	2.91	2.57	2.57
	ABS	3.63	3.82	3.61	3.26	3.63	4.59	4.44	4.02
	Glass	2.42	2.44	0.56	3.89	4.79	4.82	4.98	3.02
	Metal	2.84	2.41	2.63	2.12	3.26	3.82	5.96	3.45
	Wall	2.51	1.07	1.35	4.41	4.41	6.10	4.80	3.24
Impedance		50Ω							
Polarization		Linear							
VSWR		< 3							
Cable		3 meters TGC-200 standard, fully customizable							
Connector		SMA(M) standard, fully customizable							

MECHANICAL	
Antenna Dimensions	146*134*20mm
Casing	ASA
Weight	672g
Ingress Protection Rating	IP67
ENVIRONMENTAL	
Operation Temperature	-40°C to 85°C
Storage Temperature	-40°C to 90°C
Humidity	Non-condensing 65°C 95% RH

LTE Bands for MIMO 1 IN FREE SPACE

Band Number	LTE / LTE-Advanced / WCDMA / HSPA / HSPA+ / TD-SCDMA			
	Uplink	Downlink	MIMO 1	MIMO 2
1	UL: 1920 to 1980	DL: 2110 to 2170	✓	✓
2	UL: 1850 to 1910	DL: 1930 to 1990	✓	✓
3	UL: 1710 to 1785	DL: 1805 to 1880	✓	✓
4	UL: 1710 to 1755	DL: 2110 to 2155	✓	✓
5	UL: 824 to 849	DL: 869 to 894	✓	✓
7	UL: 2500 to 2570	DL: 2620 to 2690	✓	✓
8	UL: 880 to 915	DL: 925 to 960	✓	✓
9	UL: 1749.9 to 1784.9	DL: 1844.9 to 1879.9	✓	✓
11	UL: 1427.9 to 1447.9	DL: 1475.9 to 1495.9	✗	✗
12	UL: 699 to 716	DL: 729 to 746	✓	✓
13	UL: 777 to 787	DL: 746 to 756	✓	✓
14	UL: 788 to 798	DL: 758 to 768	✓	✓
17	UL: 704 to 716	DL: 734 to 746 (LTE only)	✓	✓
18	UL: 815 to 830	DL: 860 to 875 (LTE only)	✓	✓
19	UL: 830 to 845	DL: 875 to 890	✓	✓
20	UL: 832 to 862	DL: 791 to 821	✓	✓
21	UL: 1447.9 to 1462.9	DL: 1495.9 to 1510.9	✓	✓
22	UL: 3410 to 3490	DL: 3510 to 3590	✓	✓
23	UL: 2000 to 2020	DL: 2180 to 2200 (LTE only)	✓	✓
24	UL: 1625.5 to 1660.5	DL: 1525 to 1559 (LTE only)	✓	✓
25	UL: 1850 to 1915	DL: 1930 to 1995	✓	✓
26	UL: 814 to 849	DL: 859 to 894	✓	✓
27	UL: 807 to 824	DL: 852 to 869 (LTE only)	✓	✓
28	UL: 703 to 748	DL: 758 to 803 (LTE only)	✓	✓
29	UL: -	DL: 717 to 728 (LTE only)	✓	✓
30	UL: 2305 to 2315	DL: 2350 to 2360 (LTE only)	✓	✓
31	UL: 452.5 to 457.5	DL: 462.5 to 467.5 (LTE only)	✓	✓
32	UL: -	DL: 1452 - 1496	✓	✓
35		1850 to 1910	✓	✓
38		2570 to 2620	✓	✓
39		1880 to 1920	✓	✓
40		2300 to 2400	✓	✓
41		2496 to 2690	✓	✓
42		3400 to 3600	✓	✓
43		3600 to 3800	✓	✓

*Covered bands represent greater than 20% efficiency

LTE BANDS for MIMO 1 ON 30X30 GROUND PLANE

Band Number	LTE / LTE-Advanced / WCDMA / HSPA / HSPA+ / TD-SCDMA			
	Uplink	Downlink	MIMO 1	MIMO 2
1	UL: 1920 to 1980	DL: 2110 to 2170	✓	✓
2	UL: 1850 to 1910	DL: 1930 to 1990	✓	✓
3	UL: 1710 to 1785	DL: 1805 to 1880	✗	✓
4	UL: 1710 to 1755	DL: 2110 to 2155	✗	✓
5	UL: 824 to 849	DL: 869 to 894	✓	✓
7	UL: 2500 to 2570	DL: 2620 to 2690	✓	✓
8	UL: 880 to 915	DL: 925 to 960	✓	✓
9	UL: 1749.9 to 1784.9	DL: 1844.9 to 1879.9	✓	✓
11	UL: 1427.9 to 1447.9	DL: 1475.9 to 1495.9	✓	✓
12	UL: 699 to 716	DL: 729 to 746	✓	✓
13	UL: 777 to 787	DL: 746 to 756	✓	✓
14	UL: 788 to 798	DL: 758 to 768	✓	✓
17	UL: 704 to 716	DL: 734 to 746 (LTE only)	✓	✓
18	UL: 815 to 830	DL: 860 to 875 (LTE only)	✓	✓
19	UL: 830 to 845	DL: 875 to 890	✓	✓
20	UL: 832 to 862	DL: 791 to 821	✓	✓
21	UL: 1447.9 to 1462.9	DL: 1495.9 to 1510.9	✓	✓
22	UL: 3410 to 3490	DL: 3510 to 3590	✓	✓
23	UL: 2000 to 2020	DL: 2180 to 2200 (LTE only)	✓	✓
24	UL: 1625.5 to 1660.5	DL: 1525 to 1559 (LTE only)	✓	✓
25	UL: 1850 to 1915	DL: 1930 to 1995	✓	✓
26	UL: 814 to 849	DL: 859 to 894	✓	✓
27	UL: 807 to 824	DL: 852 to 869 (LTE only)	✓	✓
28	UL: 703 to 748	DL: 758 to 803 (LTE only)	✓	✓
29	UL: -	DL: 717 to 728 (LTE only)	✓	✓
30	UL: 2305 to 2315	DL: 2350 to 2360 (LTE only)	✓	✓
31	UL: 452.5 to 457.5	DL: 462.5 to 467.5 (LTE only)	✓	✓
32	UL: -	DL: 1452 - 1496	✓	✓
35		1850 to 1910	✓	✓
38		2570 to 2620	✓	✓
39		1880 to 1920	✓	✓
40		2300 to 2400	✓	✓
41		2496 to 2690	✓	✓
42		3400 to 3600	✓	✓
43		3600 to 3800	✓	✓

LTE Bands for MIMO 2 IN FREE SPACE

Band Number	LTE / LTE-Advanced / WCDMA / HSPA / HSPA+ / TD-SCDMA			
	Uplink	Downlink	MIMO 1	MIMO 2
1	UL: 1920 to 1980	DL: 2110 to 2170	✓	✓
2	UL: 1850 to 1910	DL: 1930 to 1990	✓	✓
3	UL: 1710 to 1785	DL: 1805 to 1880	✓	✓
4	UL: 1710 to 1755	DL: 2110 to 2155	✓	✓
5	UL: 824 to 849	DL: 869 to 894	✓	✓
7	UL: 2500 to 2570	DL: 2620 to 2690	✓	✓
8	UL: 880 to 915	DL: 925 to 960	✓	✓
9	UL: 1749.9 to 1784.9	DL: 1844.9 to 1879.9	✓	✓
11	UL: 1427.9 to 1447.9	DL: 1475.9 to 1495.9	✓	✓
12	UL: 699 to 716	DL: 729 to 746	✓	✓
13	UL: 777 to 787	DL: 746 to 756	✓	✓
14	UL: 788 to 798	DL: 758 to 768	✓	✓
17	UL: 704 to 716	DL: 734 to 746 (LTE only)	✓	✓
18	UL: 815 to 830	DL: 860 to 875 (LTE only)	✓	✓
19	UL: 830 to 845	DL: 875 to 890	✓	✓
20	UL: 832 to 862	DL: 791 to 821	✓	✓
21	UL: 1447.9 to 1462.9	DL: 1495.9 to 1510.9	✓	✓
22	UL: 3410 to 3490	DL: 3510 to 3590	✓	✓
23	UL: 2000 to 2020	DL: 2180 to 2200 (LTE only)	✓	✓
24	UL: 1625.5 to 1660.5	DL: 1525 to 1559 (LTE only)	✓	✓
25	UL: 1850 to 1915	DL: 1930 to 1995	✓	✓
26	UL: 814 to 849	DL: 859 to 894	✓	✓
27	UL: 807 to 824	DL: 852 to 869 (LTE only)	✓	✓
28	UL: 703 to 748	DL: 758 to 803 (LTE only)	✓	✓
29	UL: -	DL: 717 to 728 (LTE only)	✓	✓
30	UL: 2305 to 2315	DL: 2350 to 2360 (LTE only)	✓	✓
31	UL: 452.5 to 457.5	DL: 462.5 to 467.5 (LTE only)	✓	✓
32	UL: -	DL: 1452 - 1496	✓	✓
35		1850 to 1910	✓	✓
38		2570 to 2620	✓	✓
39		1880 to 1920	✓	✓
40		2300 to 2400	✓	✓
41		2496 to 2690	✓	✓
42		3400 to 3600	✓	✓
43		3600 to 3800	✓	✓

LTE BANDS for MIMO 2 ON 30X30 GROUND PLANE

Band Number	LTE / LTE-Advanced / WCDMA / HSPA / HSPA+ / TD-SCDMA			
	Uplink	Downlink	MIMO 1	MIMO 2
1	UL: 1920 to 1980	DL: 2110 to 2170	✓	✓
2	UL: 1850 to 1910	DL: 1930 to 1990	✓	✓
3	UL: 1710 to 1785	DL: 1805 to 1880	✓	✓
4	UL: 1710 to 1755	DL: 2110 to 2155	✓	✓
5	UL: 824 to 849	DL: 869 to 894	✓	✓
7	UL: 2500 to 2570	DL: 2620 to 2690	✓	✓
8	UL: 880 to 915	DL: 925 to 960	✓	✓
9	UL: 1749.9 to 1784.9	DL: 1844.9 to 1879.9	✓	✓
11	UL: 1427.9 to 1447.9	DL: 1475.9 to 1495.9	✓	✓
12	UL: 699 to 716	DL: 729 to 746	✓	✓
13	UL: 777 to 787	DL: 746 to 756	✓	✓
14	UL: 788 to 798	DL: 758 to 768	✓	✓
17	UL: 704 to 716	DL: 734 to 746 (LTE only)	✓	✓
18	UL: 815 to 830	DL: 860 to 875 (LTE only)	✓	✓
19	UL: 830 to 845	DL: 875 to 890	✓	✓
20	UL: 832 to 862	DL: 791 to 821	✓	✓
21	UL: 1447.9 to 1462.9	DL: 1495.9 to 1510.9	✓	✓
22	UL: 3410 to 3490	DL: 3510 to 3590	✓	✓
23	UL: 2000 to 2020	DL: 2180 to 2200 (LTE only)	✓	✓
24	UL: 1625.5 to 1660.5	DL: 1525 to 1559 (LTE only)	✓	✓
25	UL: 1850 to 1915	DL: 1930 to 1995	✓	✓
26	UL: 814 to 849	DL: 859 to 894	✓	✓
27	UL: 807 to 824	DL: 852 to 869 (LTE only)	✓	✓
28	UL: 703 to 748	DL: 758 to 803 (LTE only)	✓	✓
29	UL: -	DL: 717 to 728 (LTE only)	✓	✓
30	UL: 2305 to 2315	DL: 2350 to 2360 (LTE only)	✓	✓
31	UL: 452.5 to 457.5	DL: 462.5 to 467.5 (LTE only)	✓	✓
32	UL: -	DL: 1452 - 1496	✓	✓
35		1850 to 1910	✓	✓
38		2570 to 2620	✓	✓
39		1880 to 1920	✓	✓
40		2300 to 2400	✓	✓
41		2496 to 2690	✓	✓
42		3400 to 3600	✓	✓
43		3600 to 3800	✓	✓

3. Antenna Characteristics

3.1 LTE_MIMO

3.1.1 Test Setup

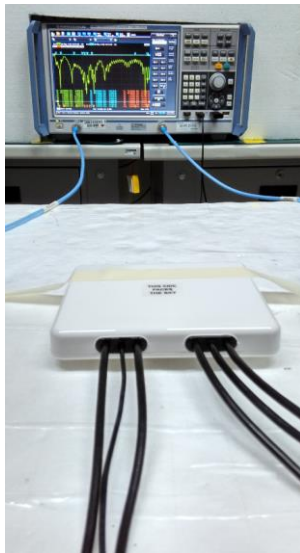

Free space



ABS

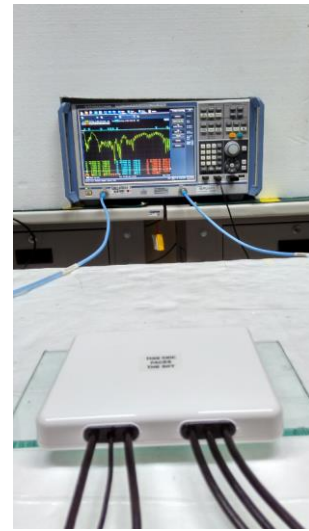

Glass

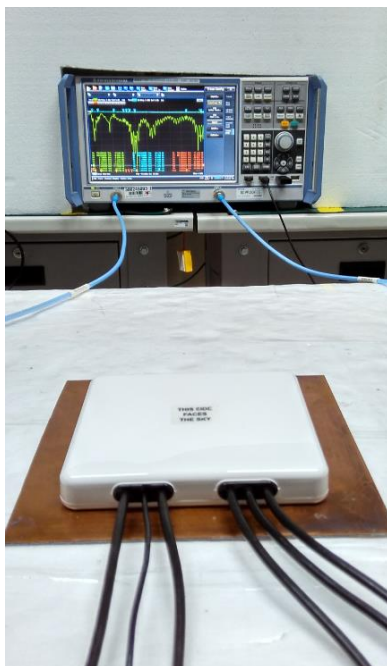

Metal

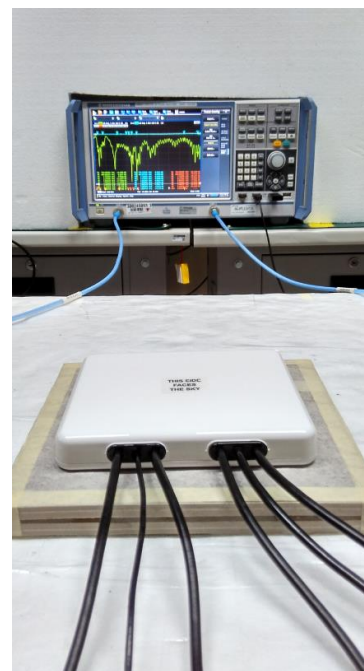

Wall

3.1.2 LTE 1 Antenna Return Loss

Performance in different environments with 1 meter cable length

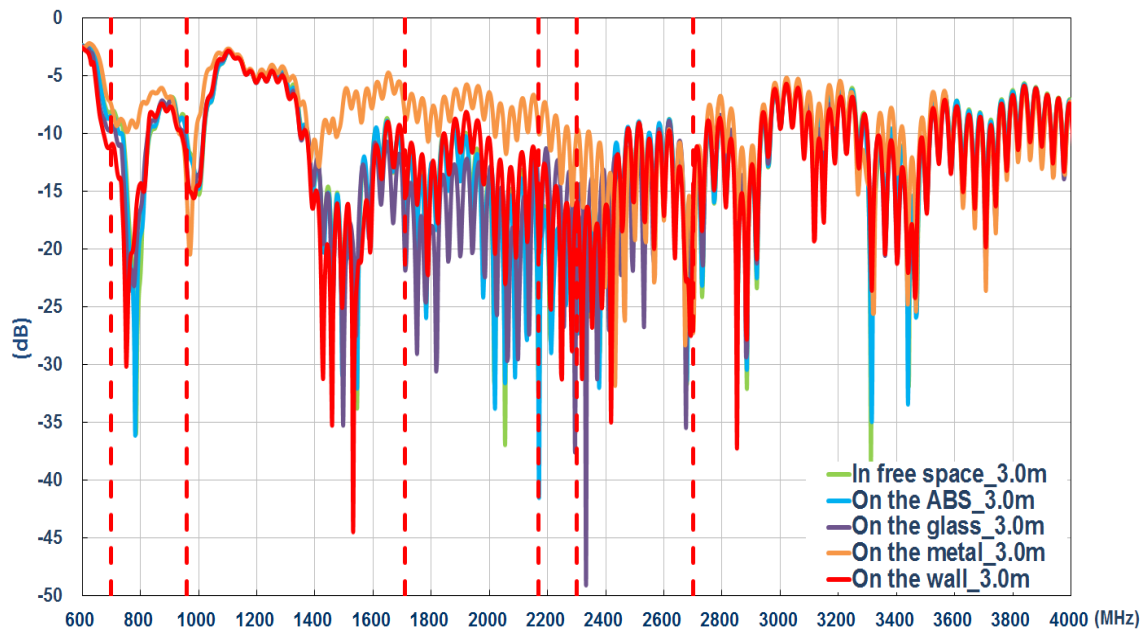

3.1.3 LTE 2 Antenna Return Loss

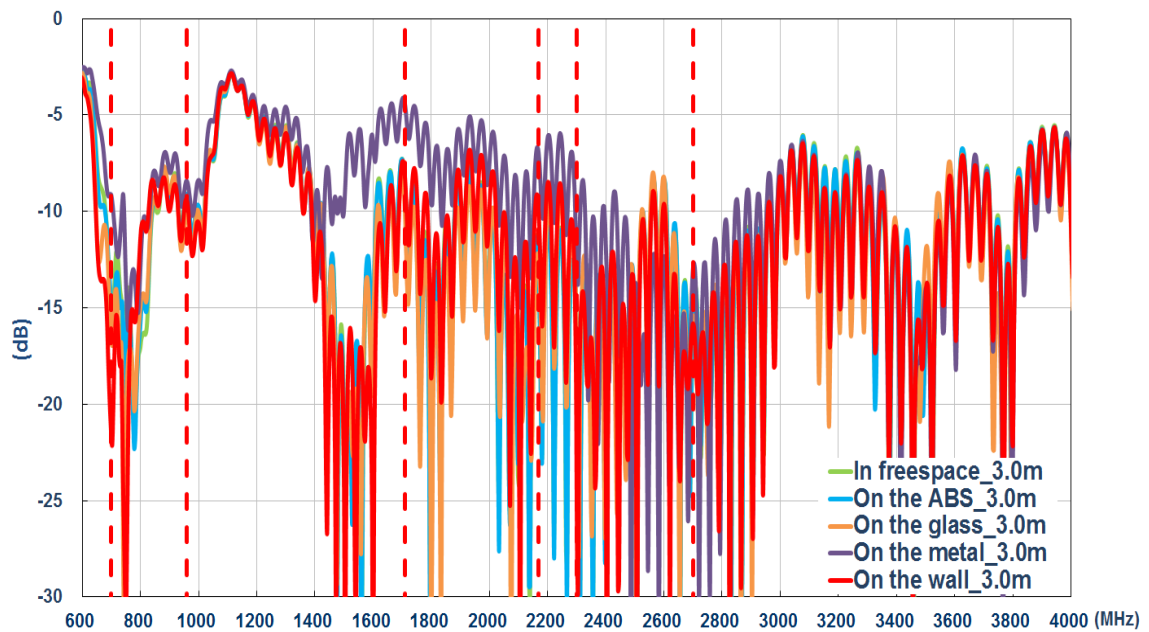

3.1.4 LTE Envelope Correlation Coefficient

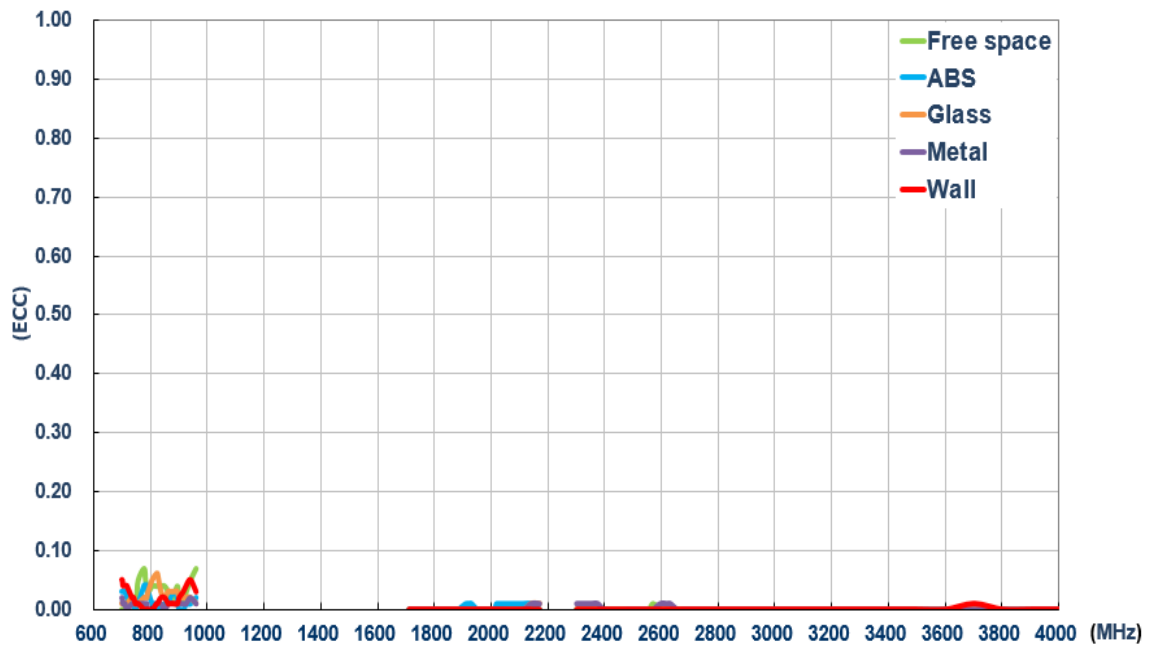

3.1.5 LTE 1 Antenna Efficiency

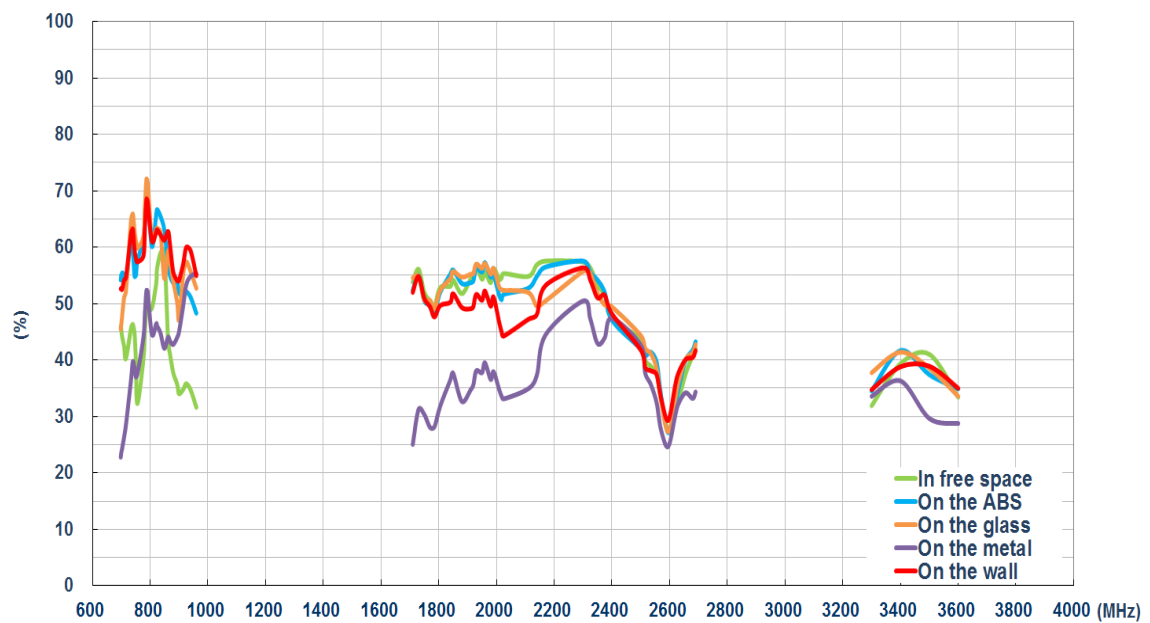

3.1.6 LTE 2 Antenna Efficiency

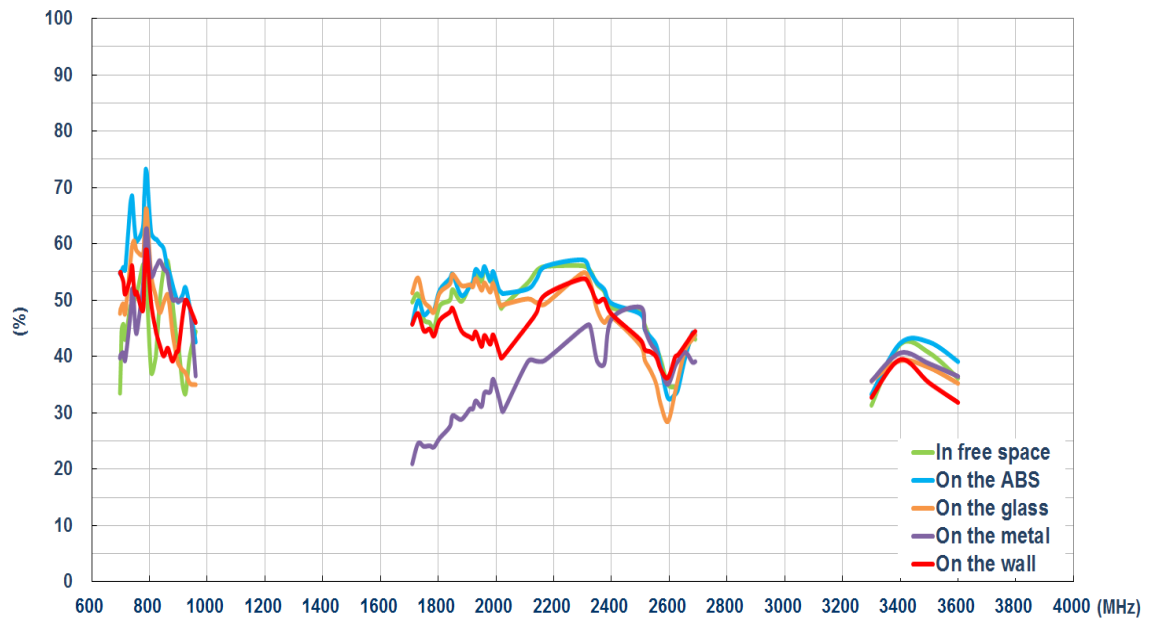

3.1.7 LTE 1 Antenna Average Gain

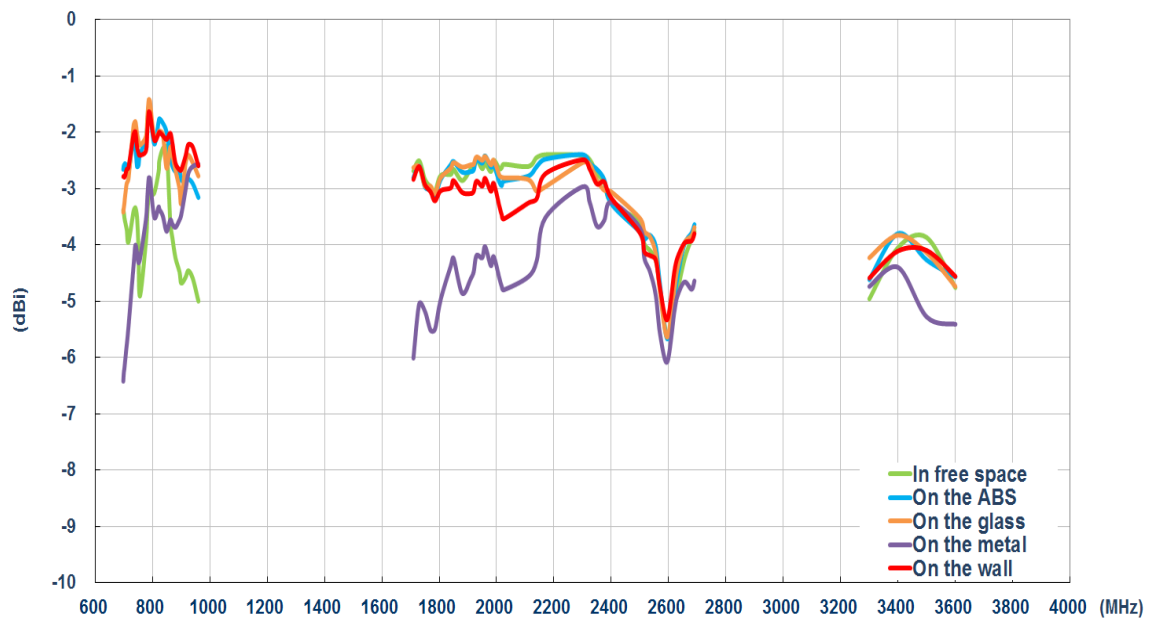

3.1.8 LTE 2 Antenna Average Gain

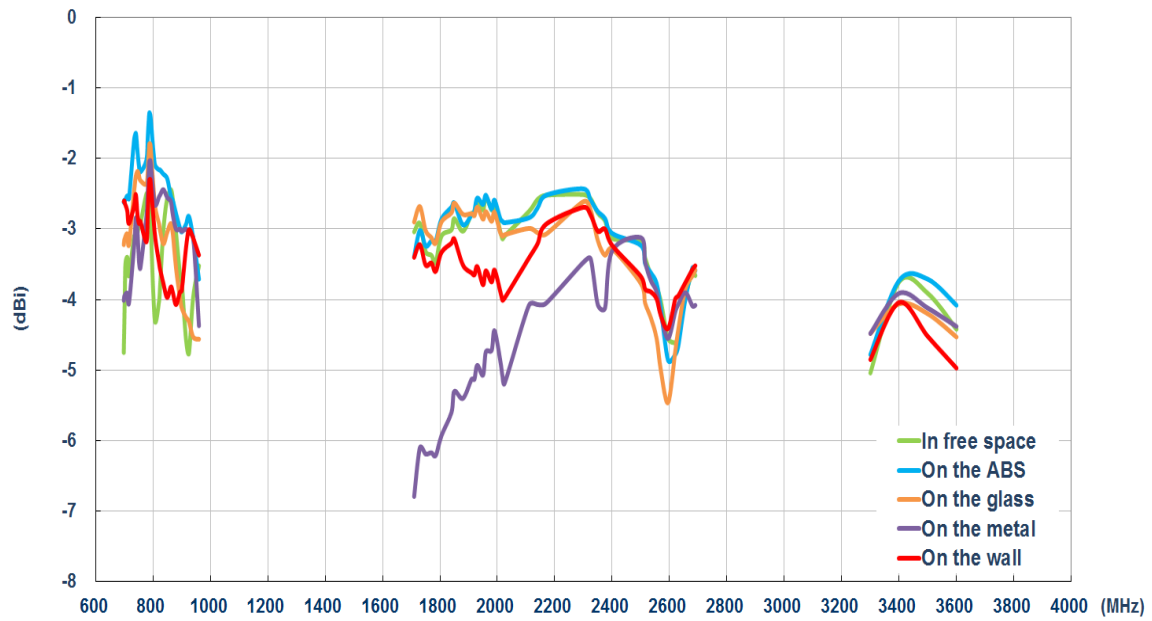

3.1.9 LTE 1 Antenna Peak Gain

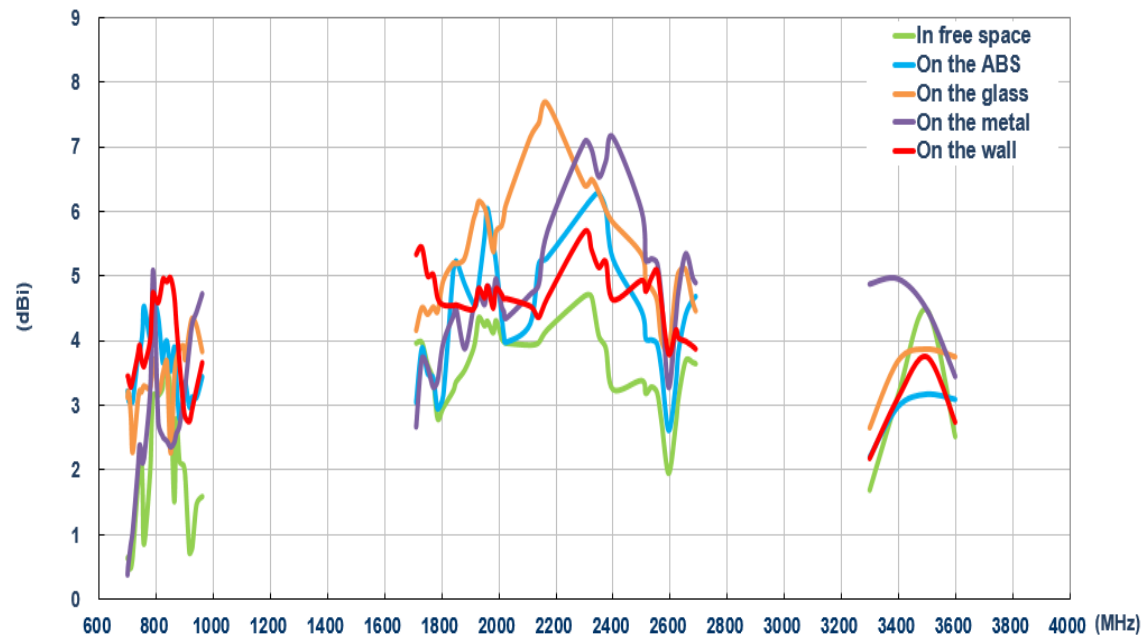

3.1.10 LTE 2 Antenna Peak Gain

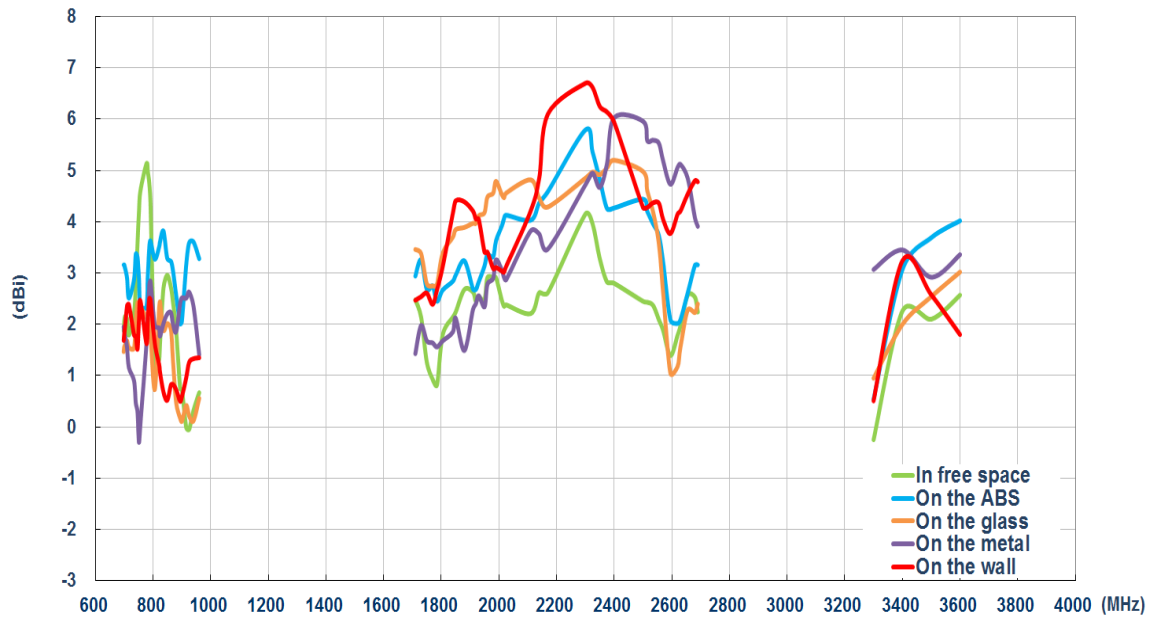

3.1.11 Test Setup for Antenna Radiation Pattern

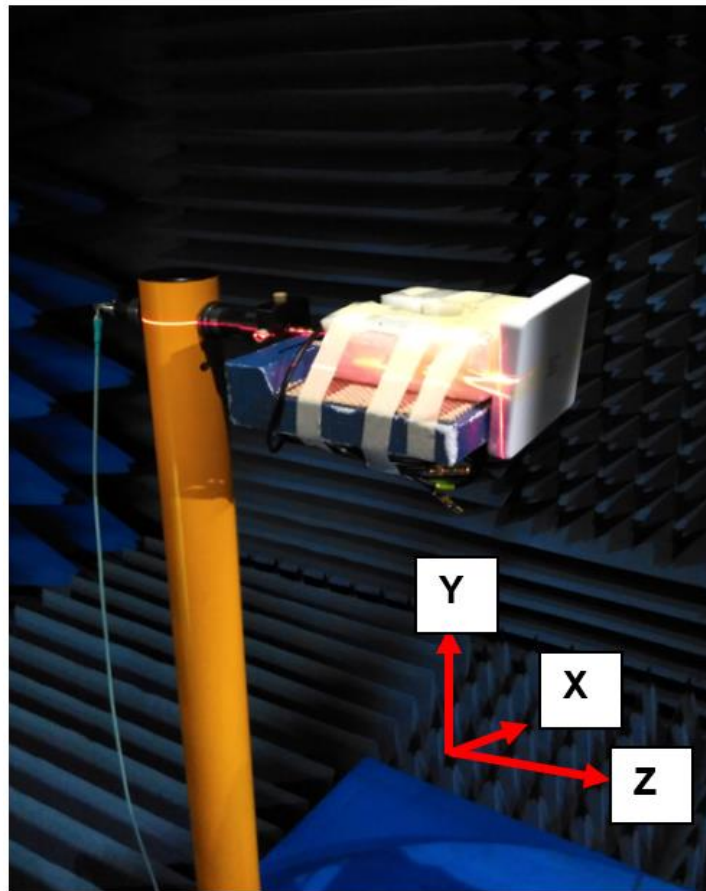

In free space

3.1.12 2D Radiation Patterns (LTE_MIMO1 with 3M cable length in free space)

XY Plane

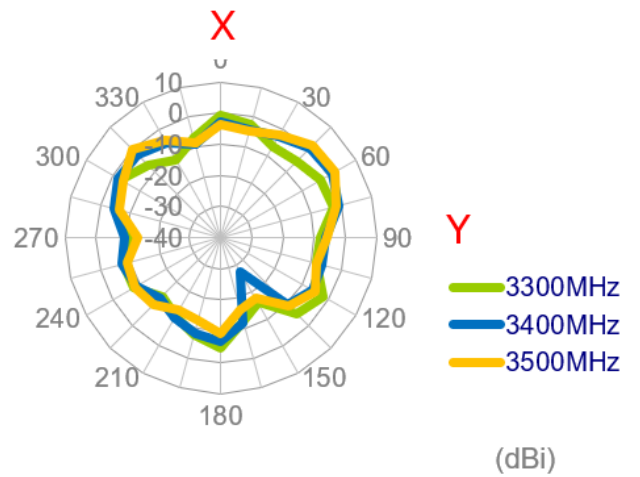
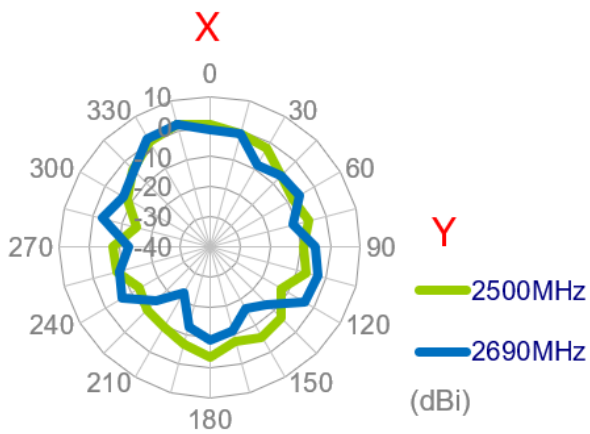
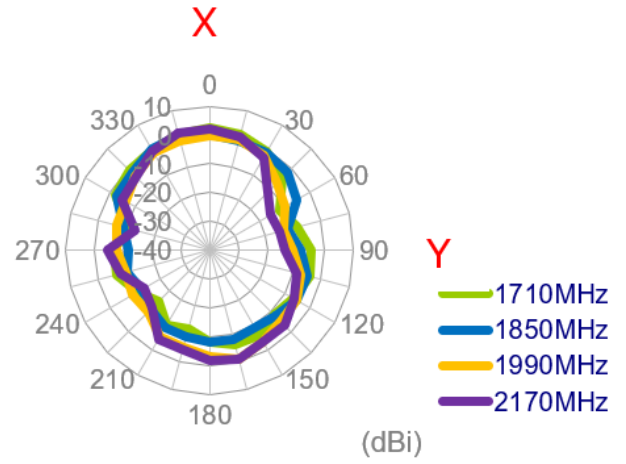
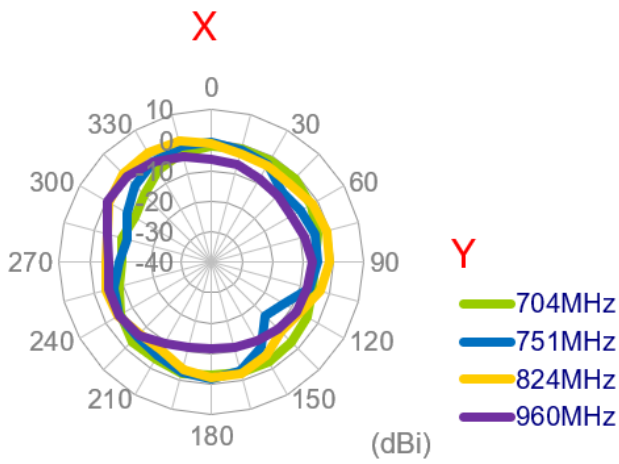

XZ Plane

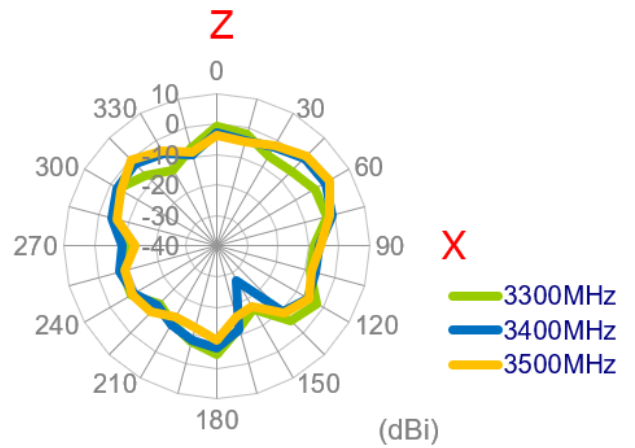
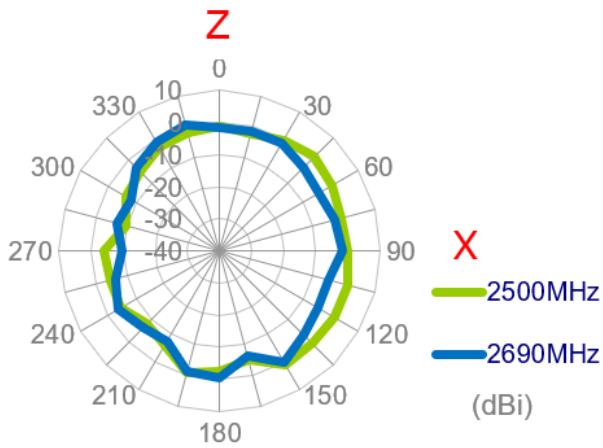
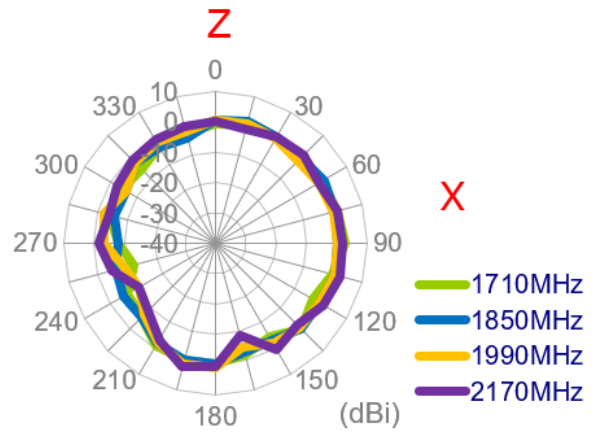
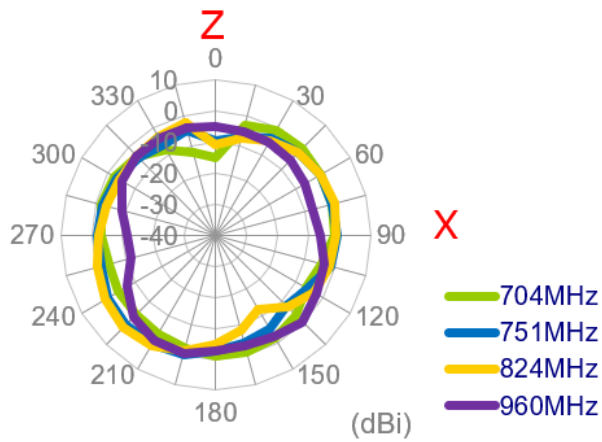

YZ Plane

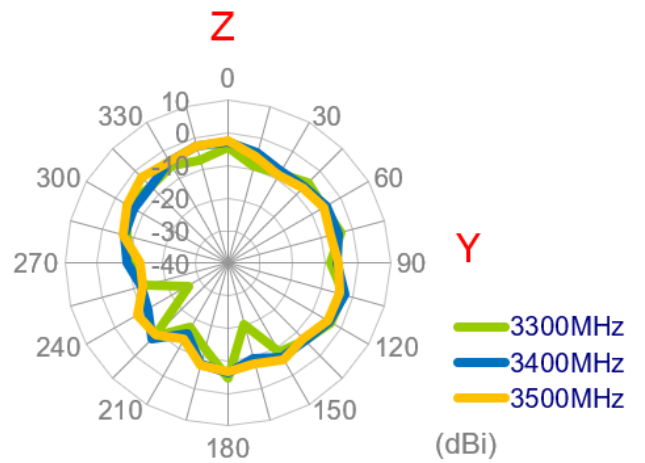
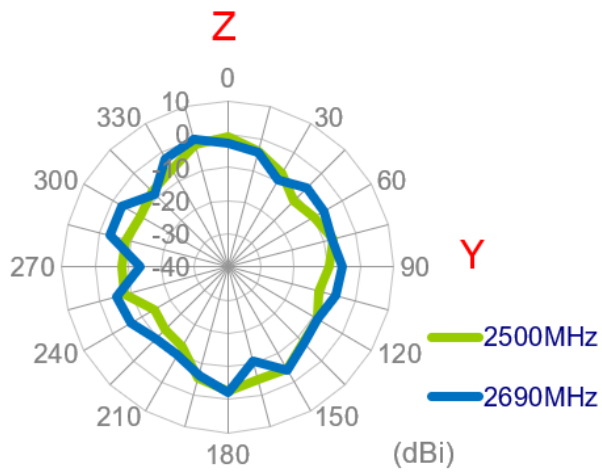
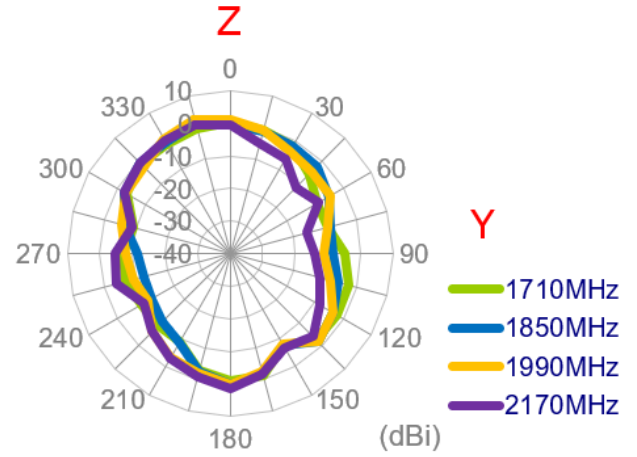
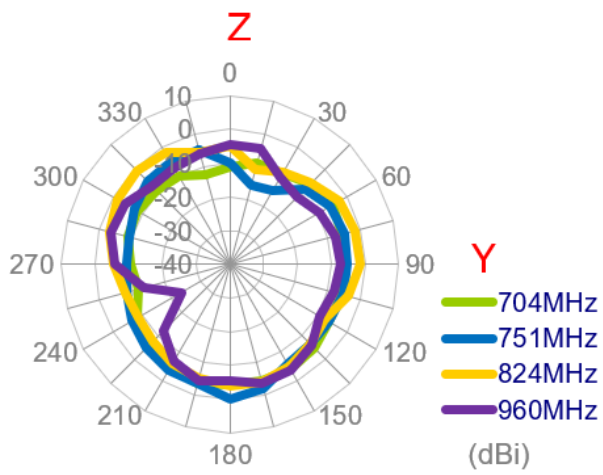

3.1.13 3D Radiation Patterns (LTE_MIMO1 with 3M cable length in free space)

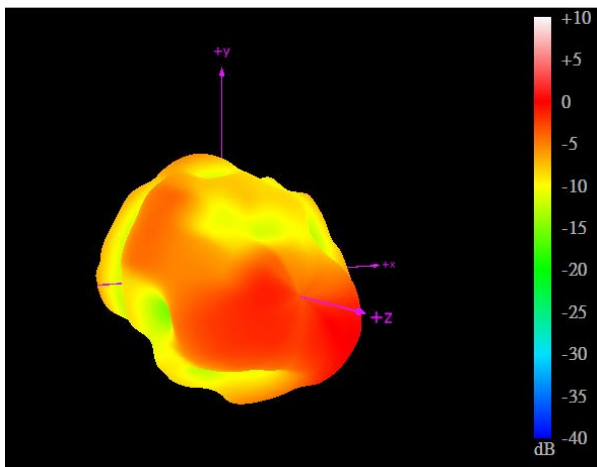

704MHz

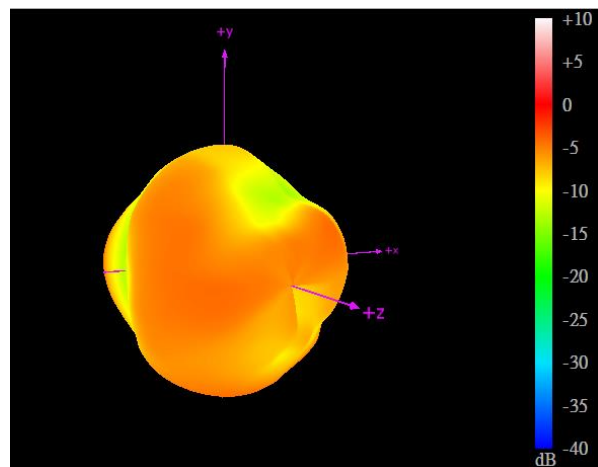

960MHz

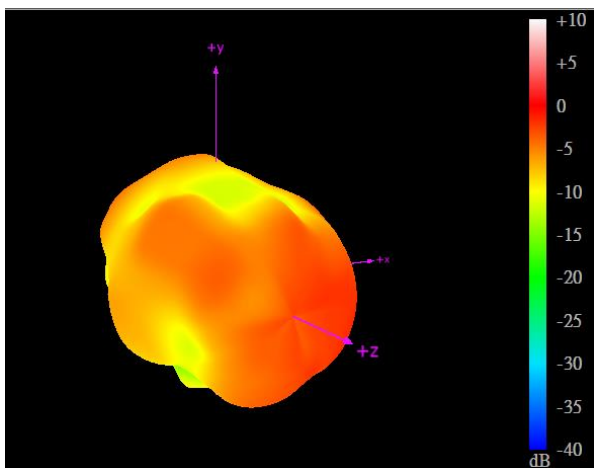

1710MHz

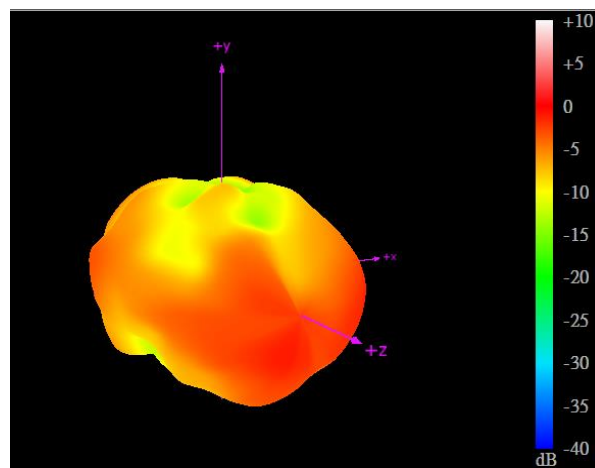

2170MHz

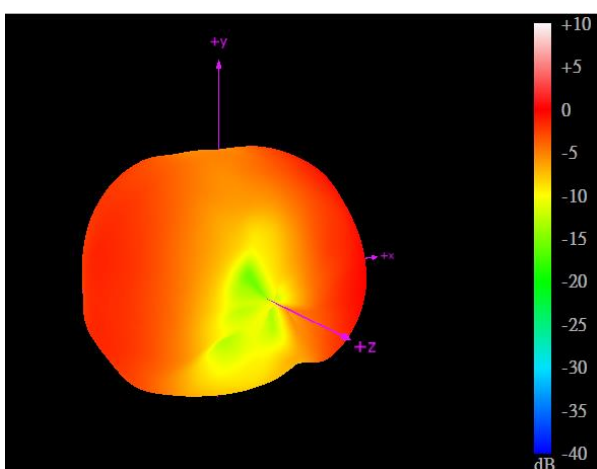

2690MHz

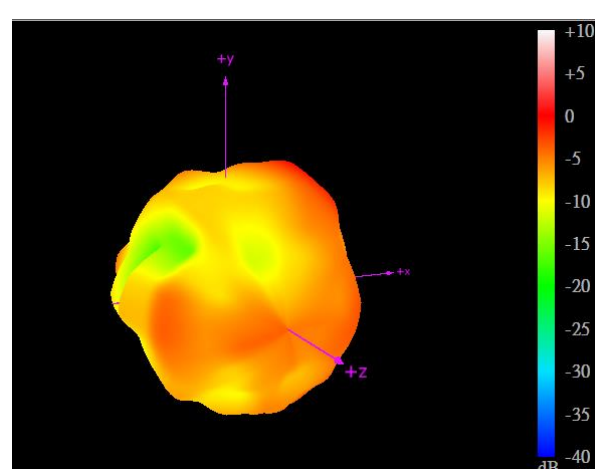

3500MHz

3.1.14 2D Radiation Patterns (LTE_MIMO2 with 3M cable length in free space)

XY Plane

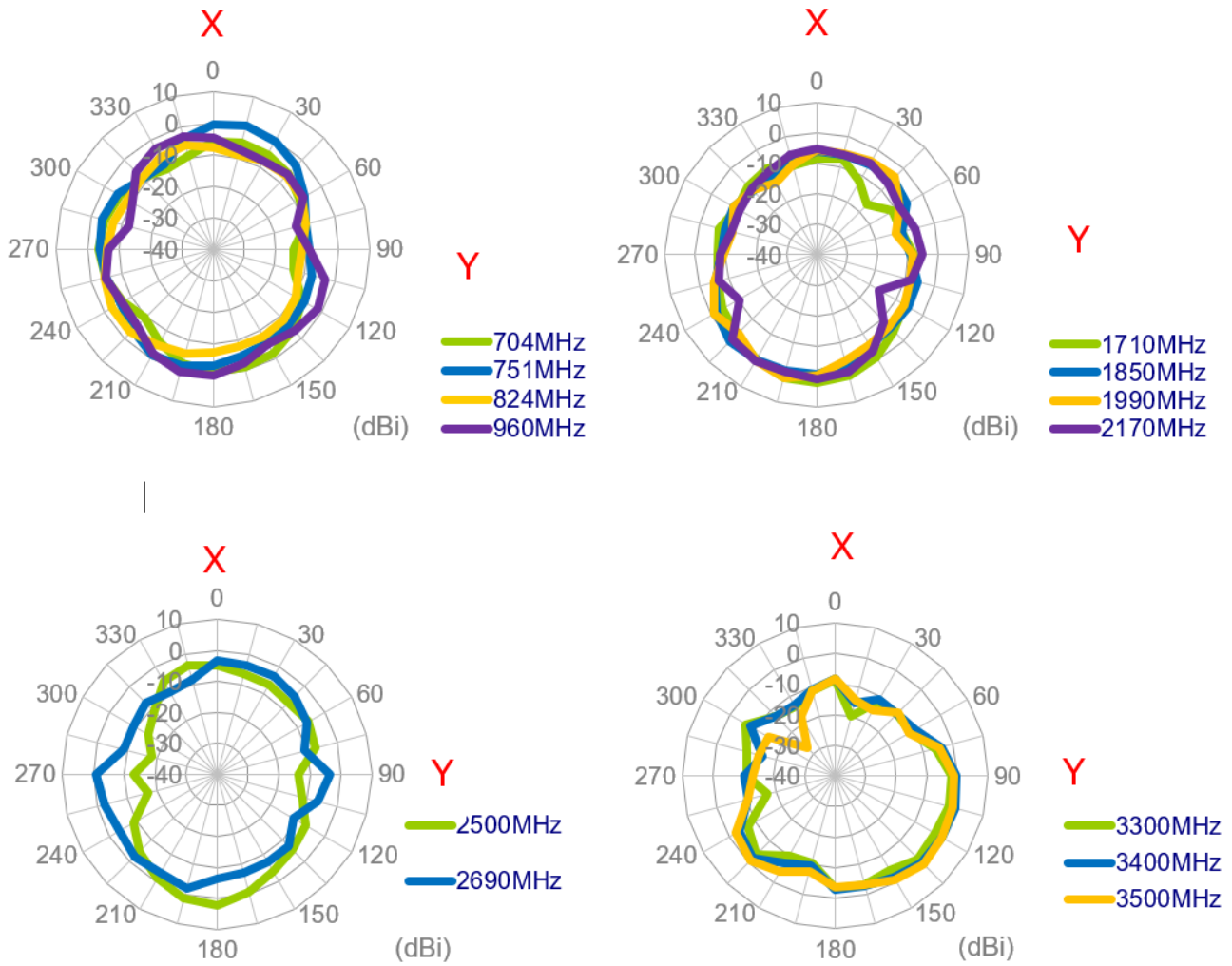

XZ Plane

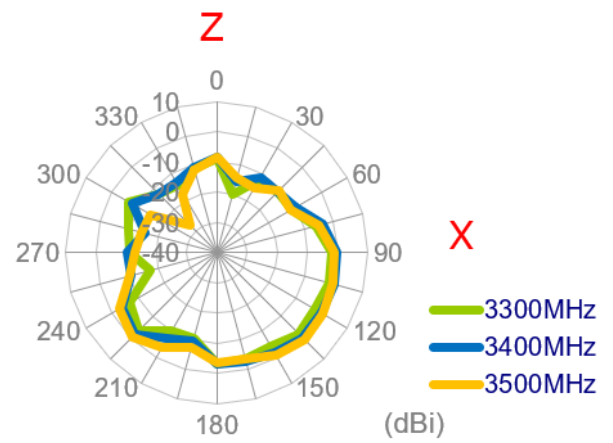
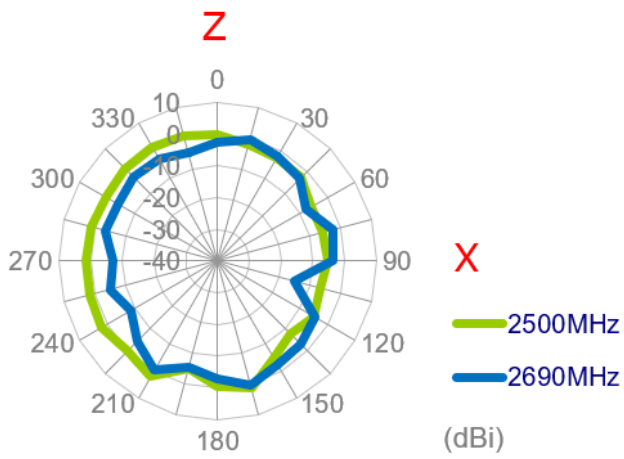
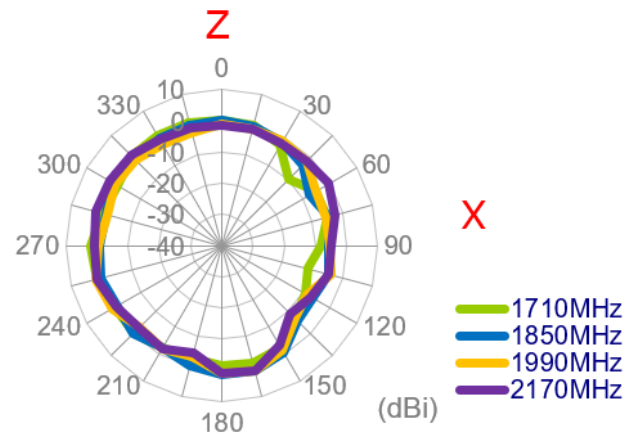
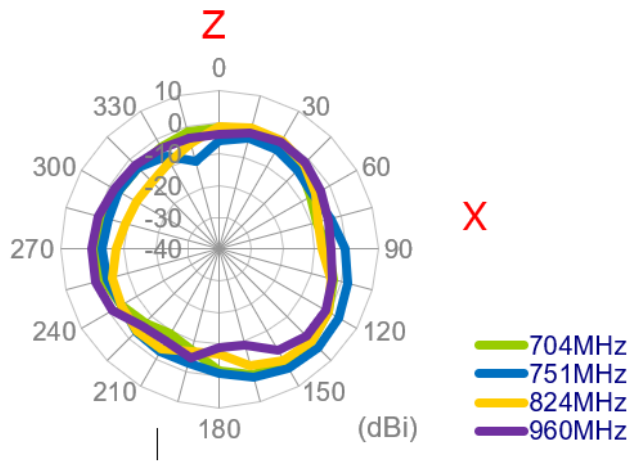

YZ Plane

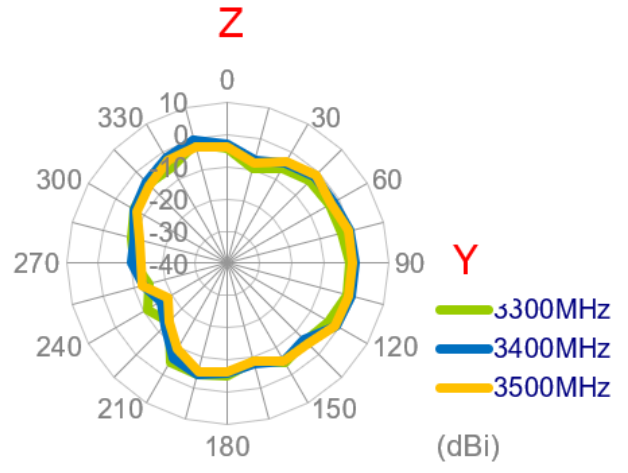
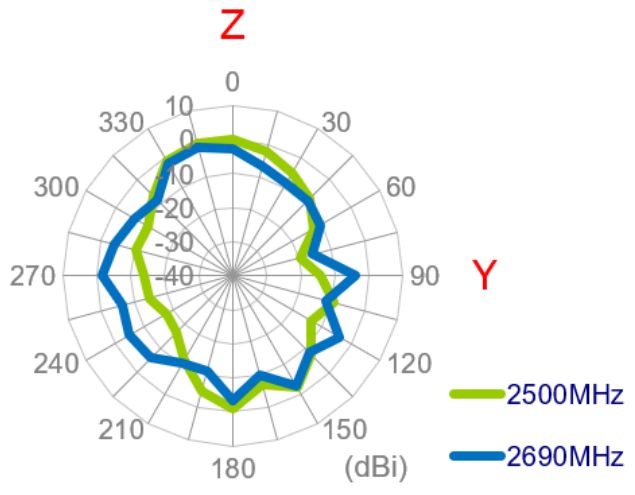
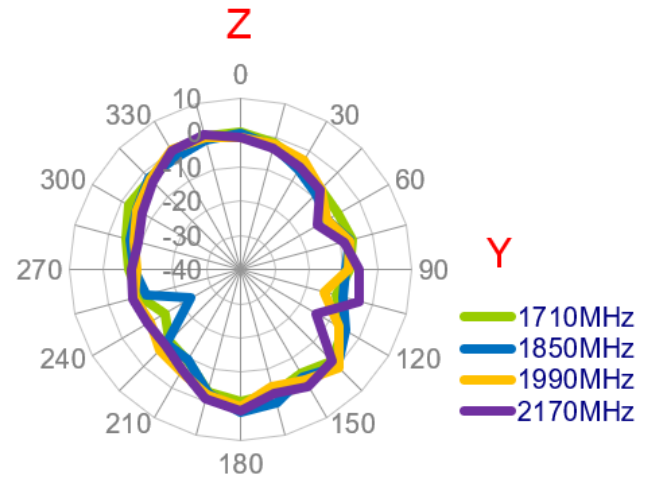
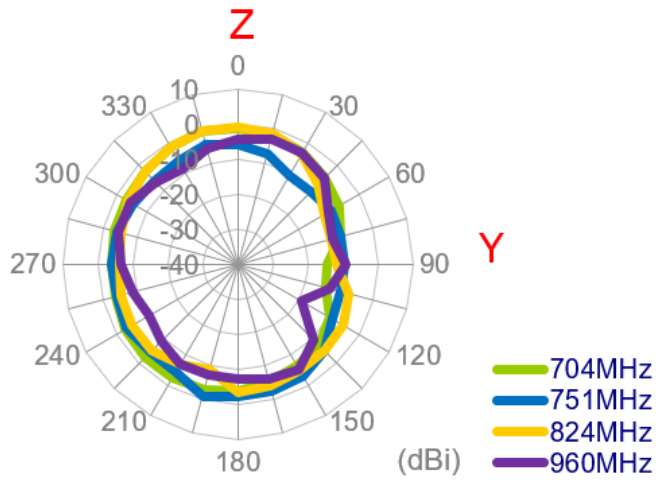

3.1.15 3D Radiation Patterns (LTE_MIMO2 with 1M cable length in free space)

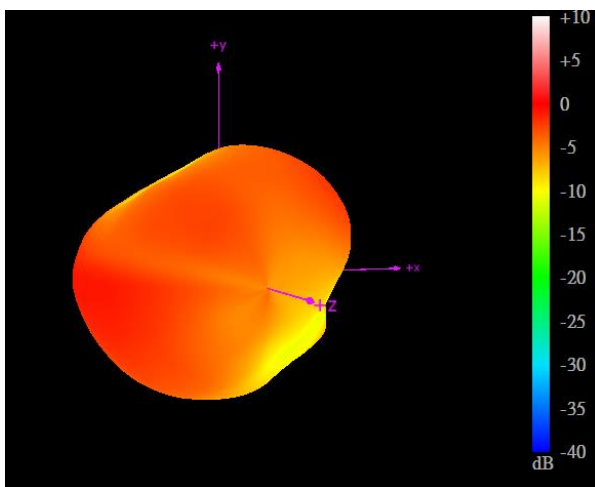

704MHz

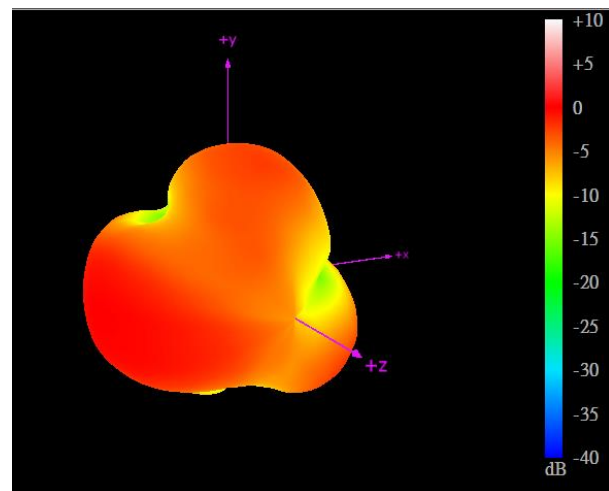

960MHz

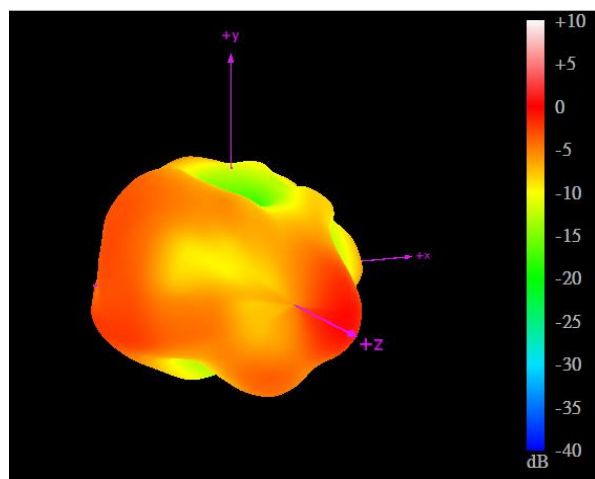

1710MHz

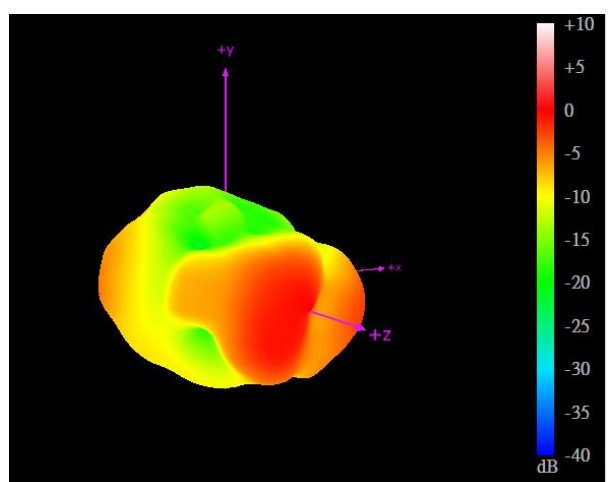

2170MHz

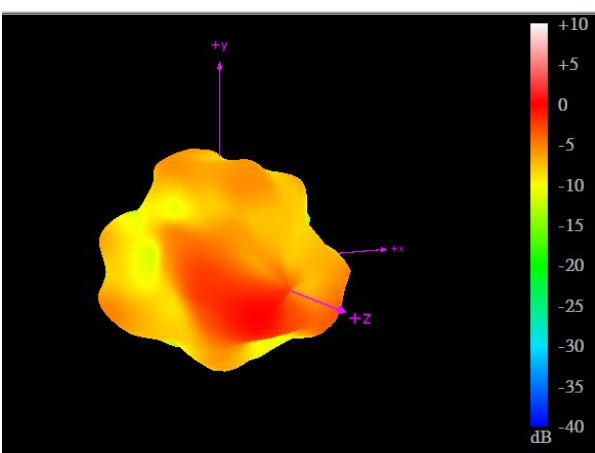

2690MHz

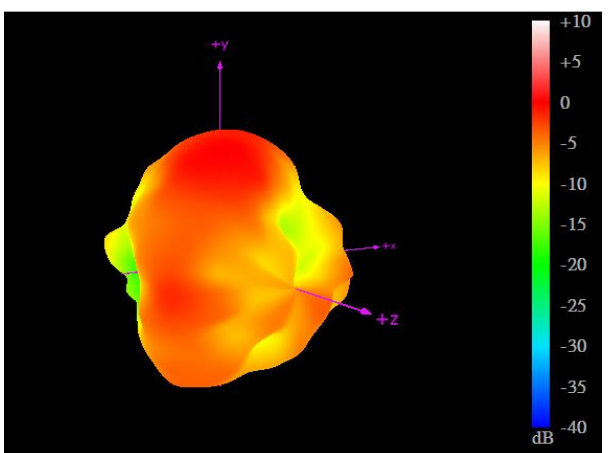

3500MHz

3.1.16 Test Setup for Antenna Radiation Pattern

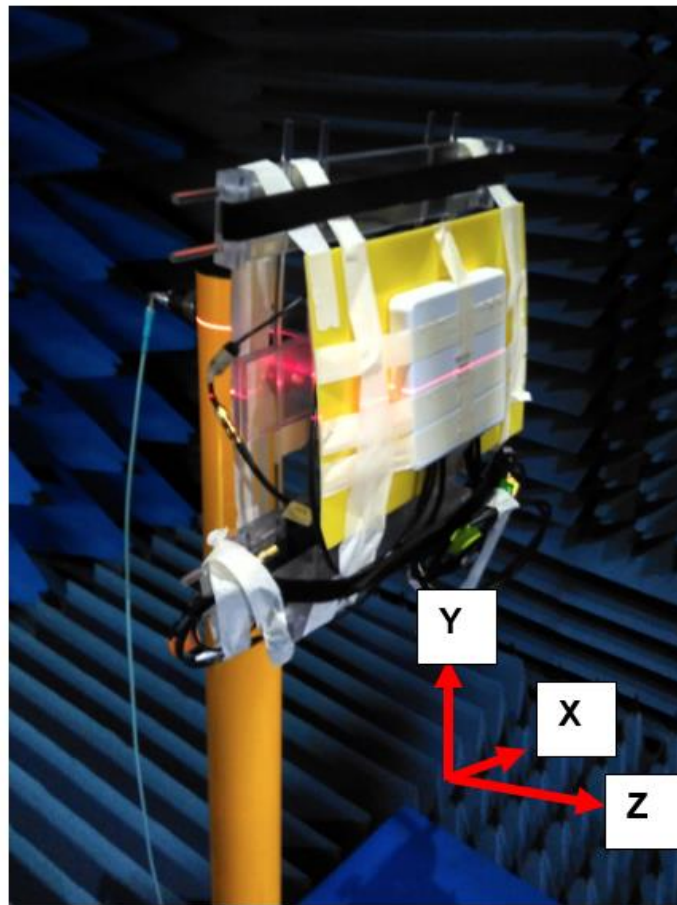

On the ABS

3.1.17 2D Radiation Patterns (LTE_MIMO1 with 3M cable length on the ABS)

XY Plane

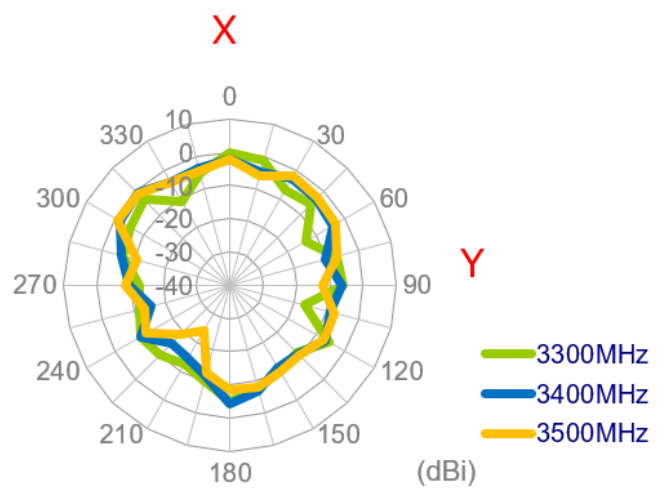
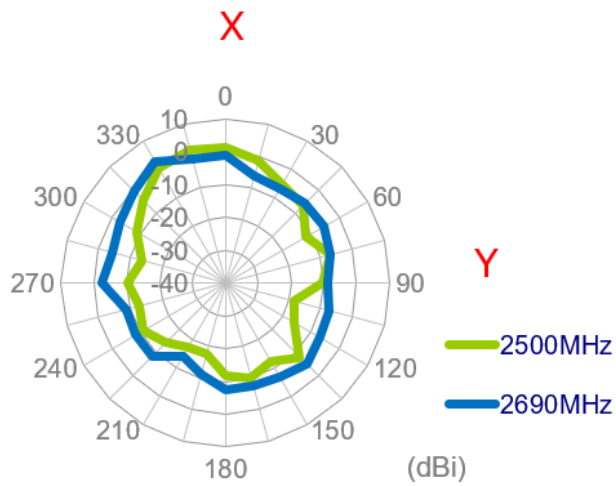
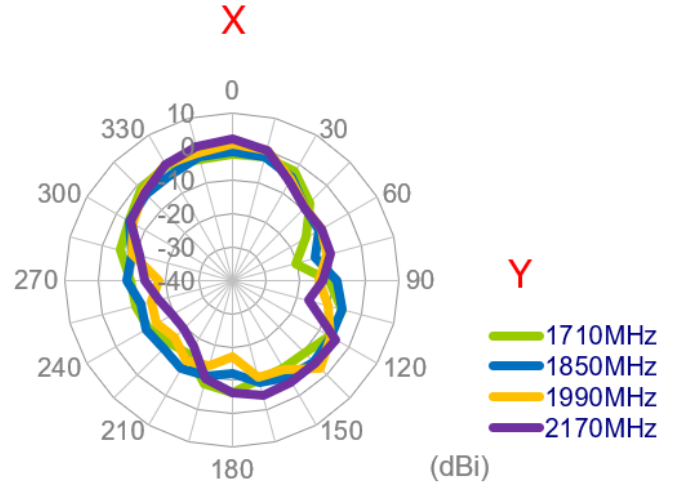
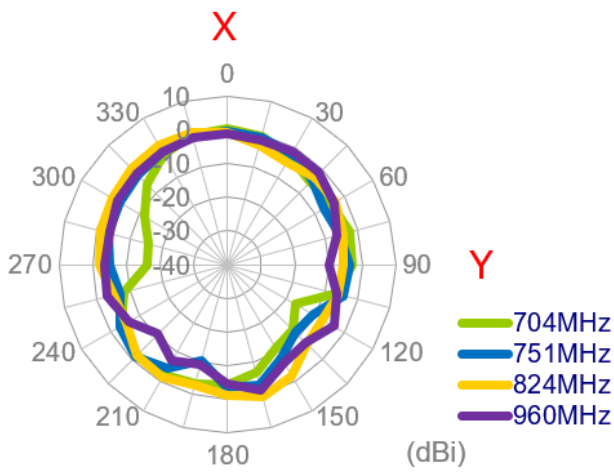

XZ Plane

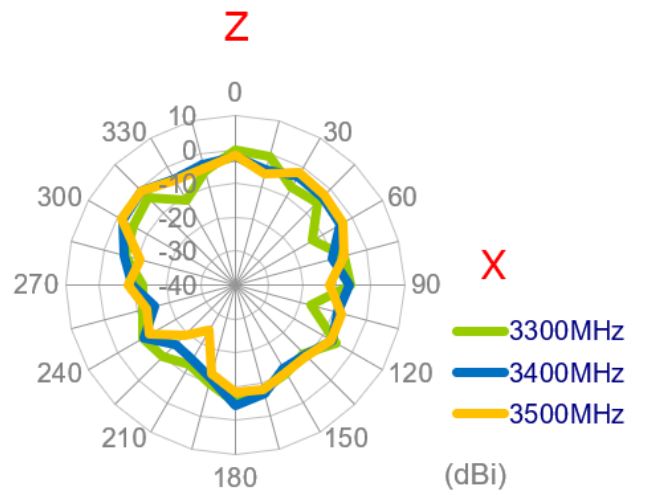
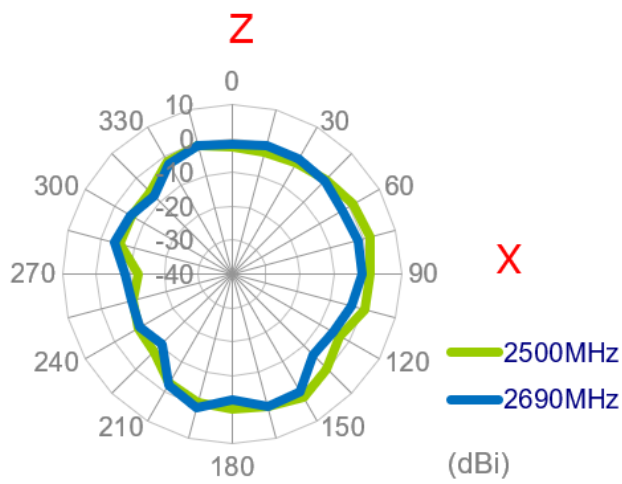
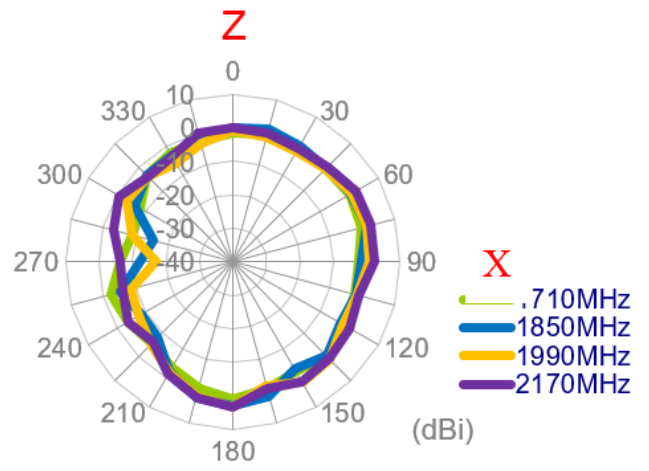
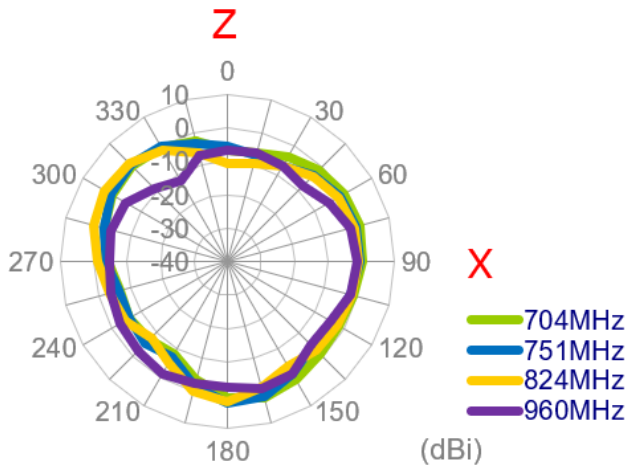

ZY Plane

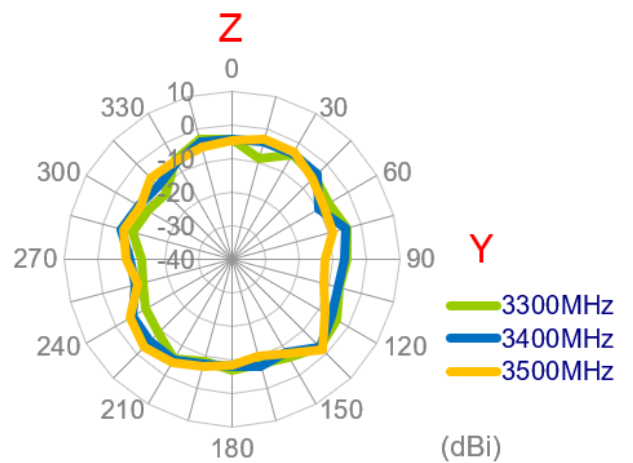
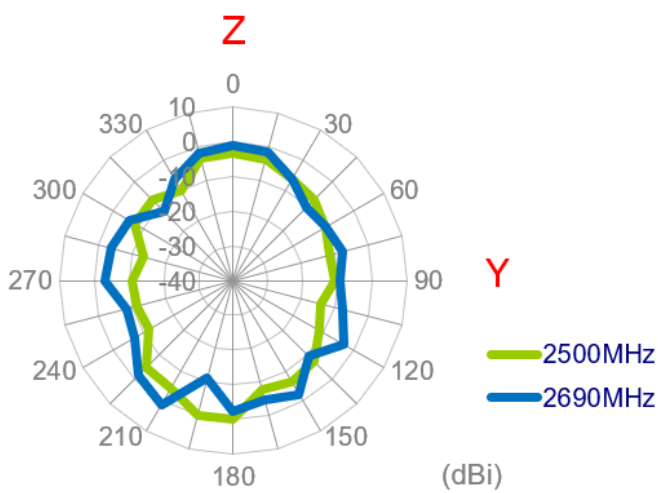
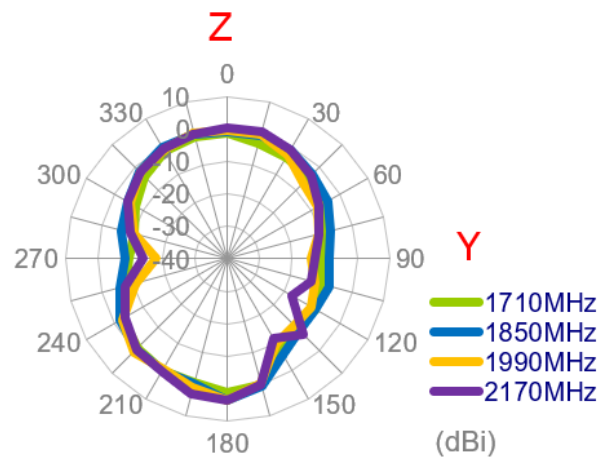
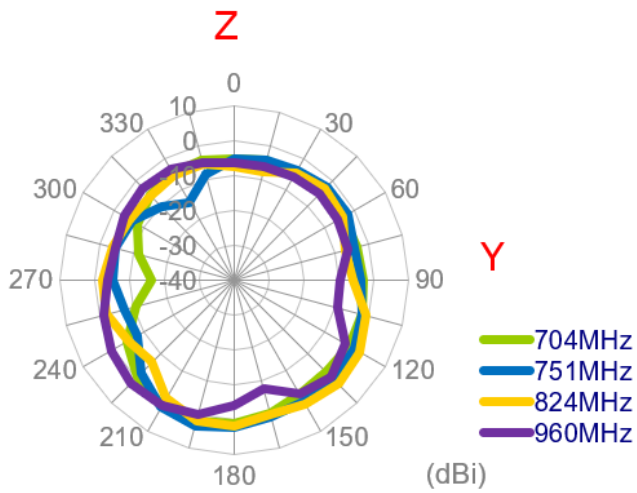

3.1.18 3D Radiation Patterns (LTE_MIMO1 with 3m cable length in free space)

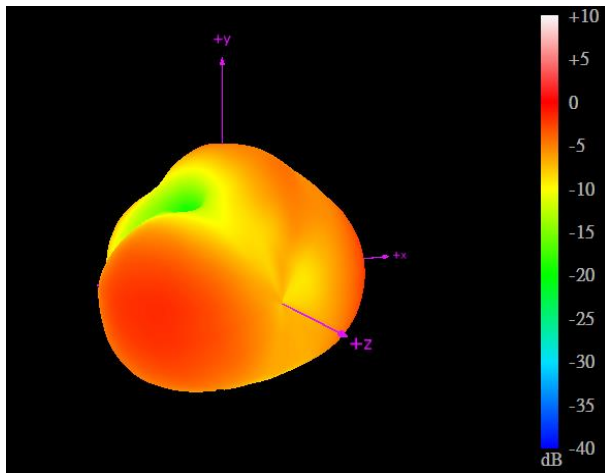

704MHz

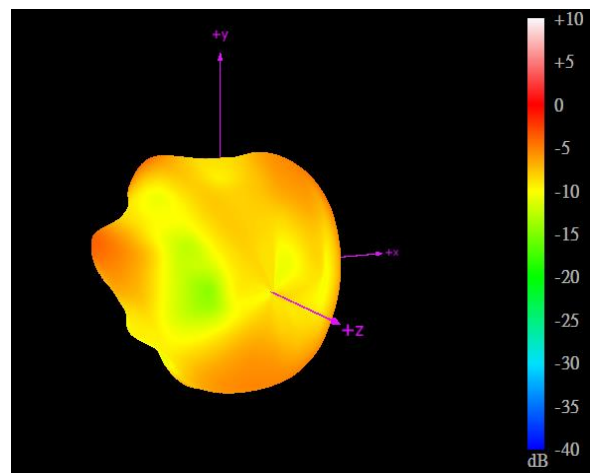

960MHz

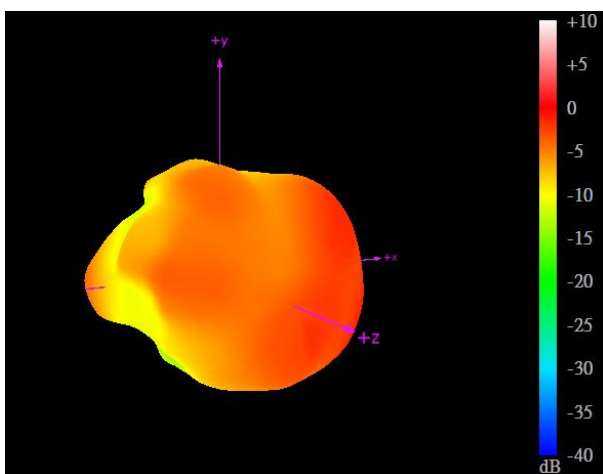

1710MHz

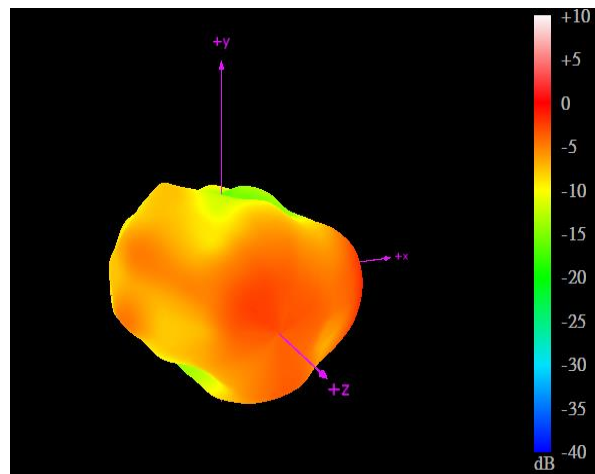

2170MHz

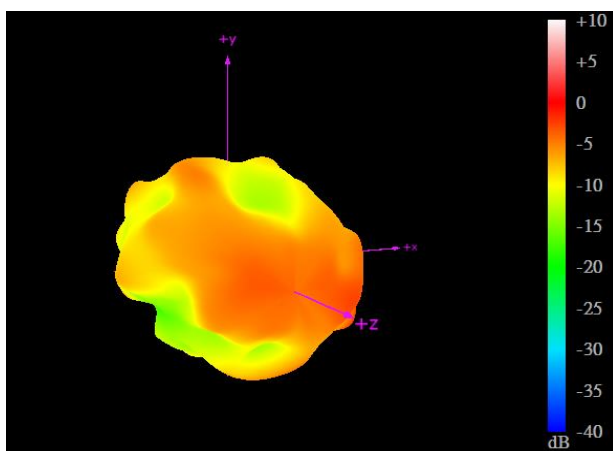

2690MHz

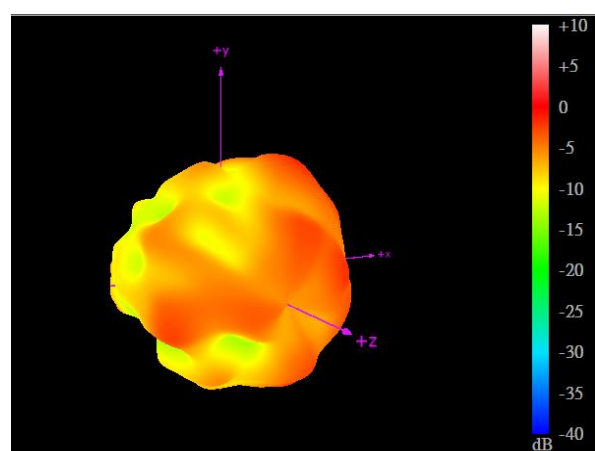

3500MHz

3.1.19 2D Radiation Patterns (LTE_MIMO2 with 3m cable length on the ABS)

XY Plane

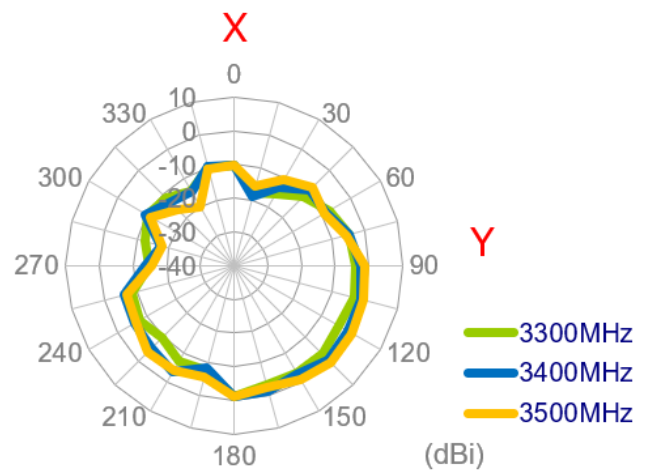
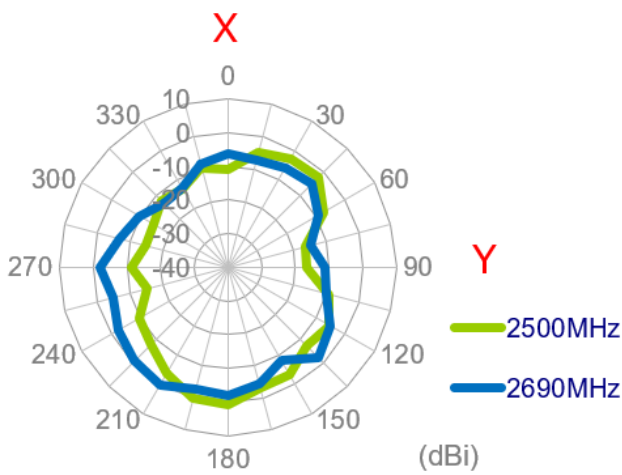
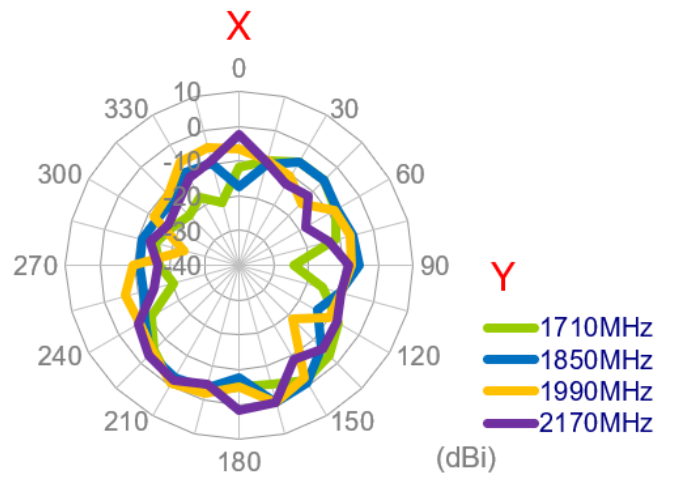
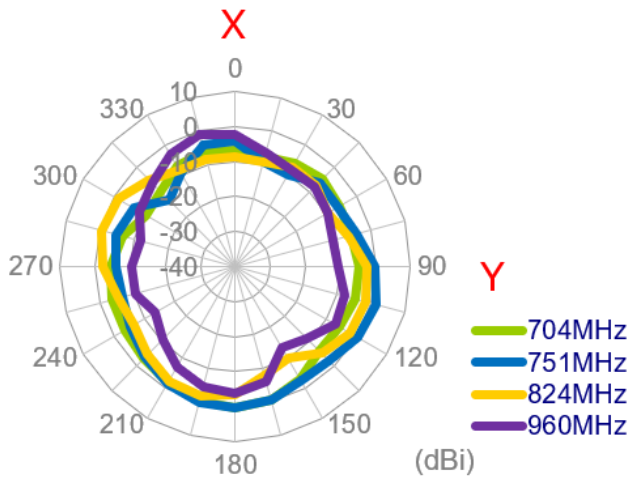

XZ Plane

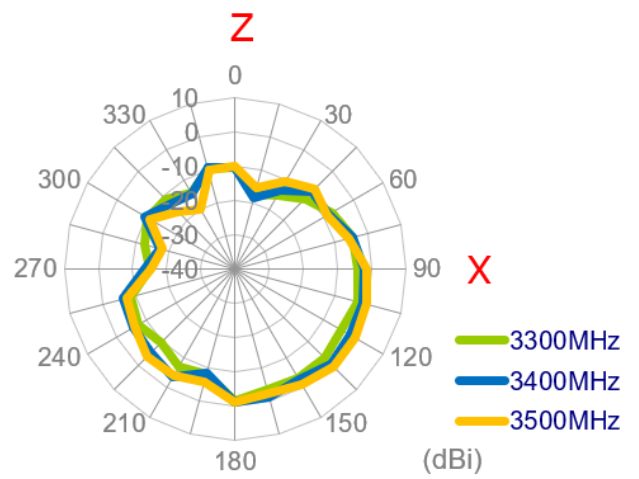
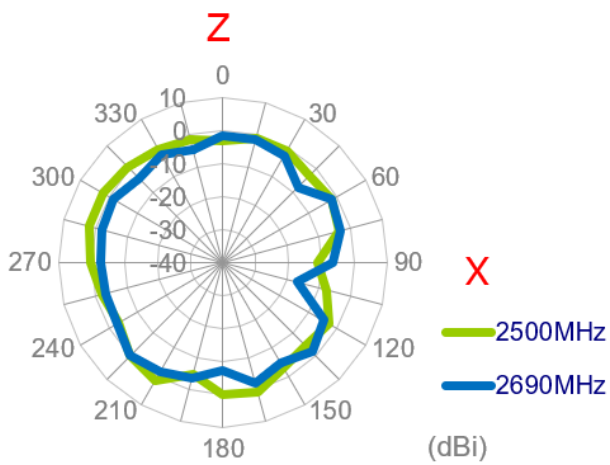
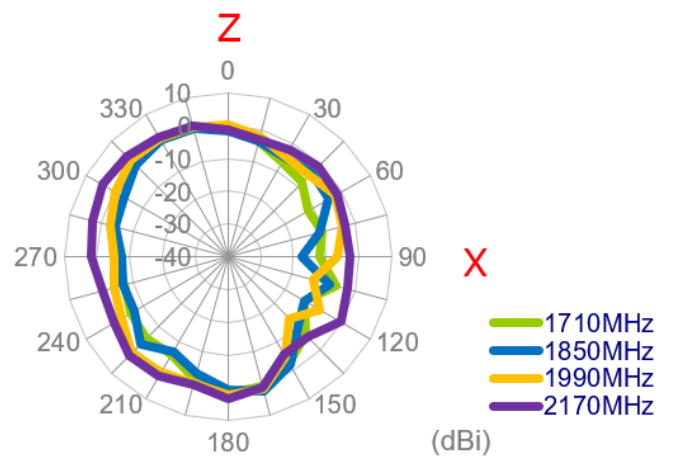
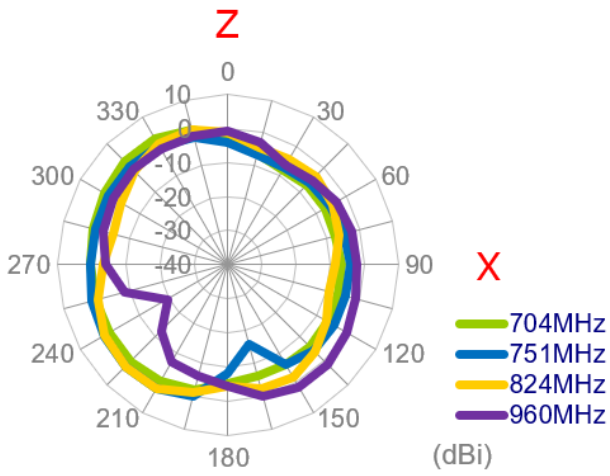

ZY Plane

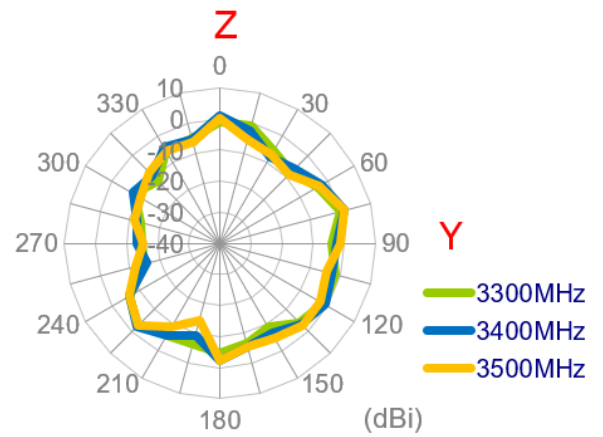
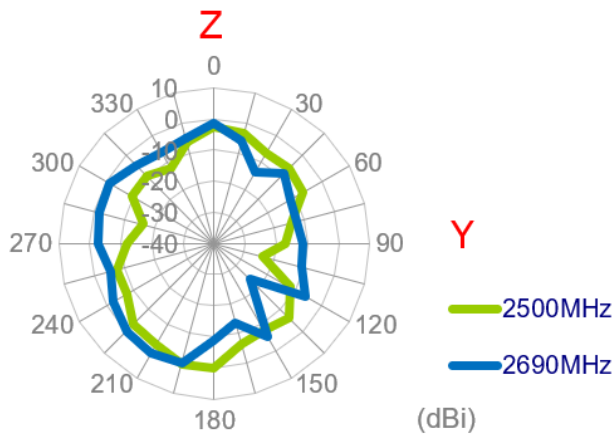
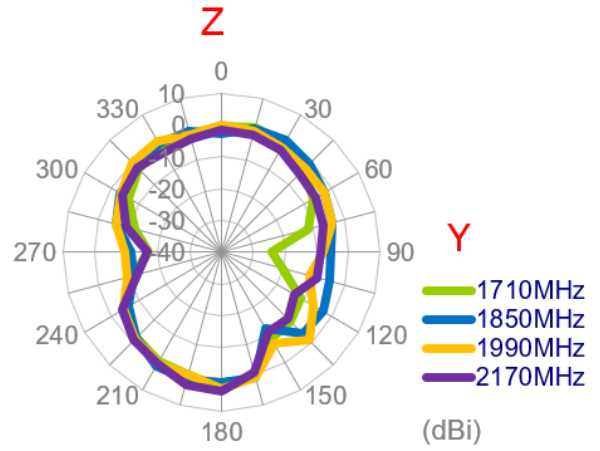
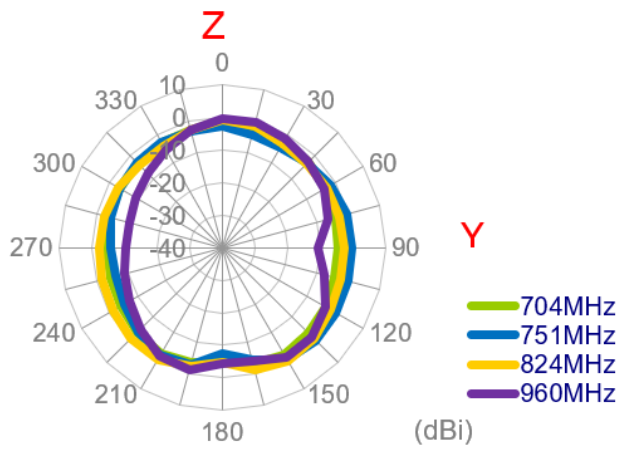

3.1.20 3D Radiation Patterns (LTE_MIMO2 with 3m cable length on the ABS)

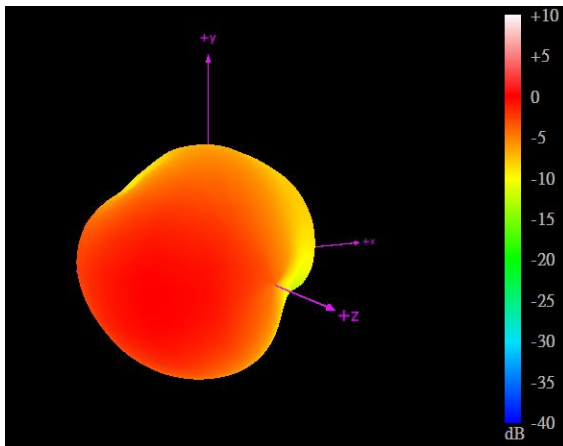

704MHz

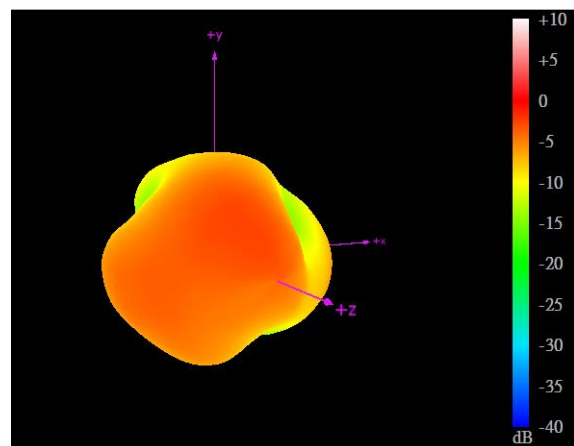

960MHz

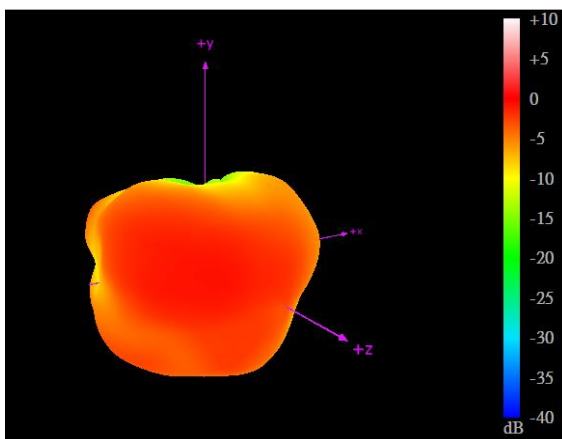

1710MHz

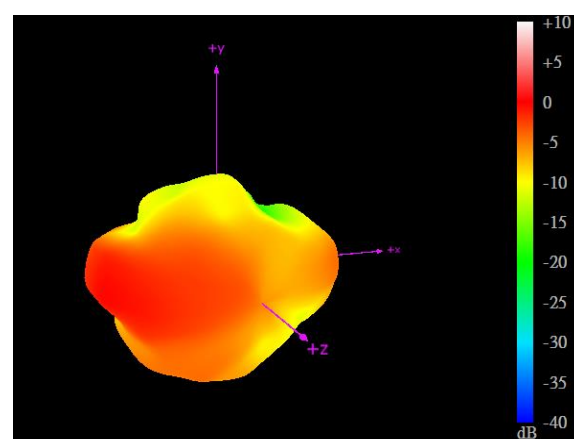

2170MHz

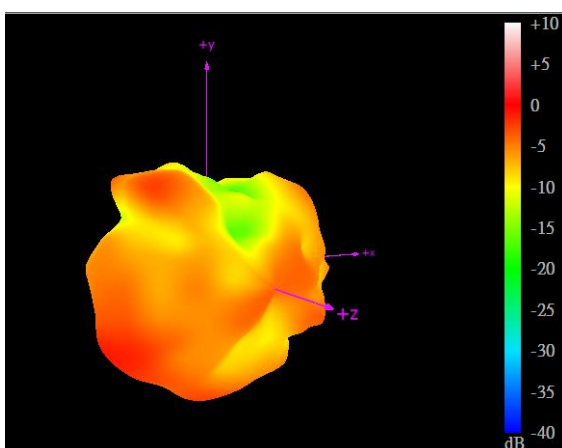

2690MHz

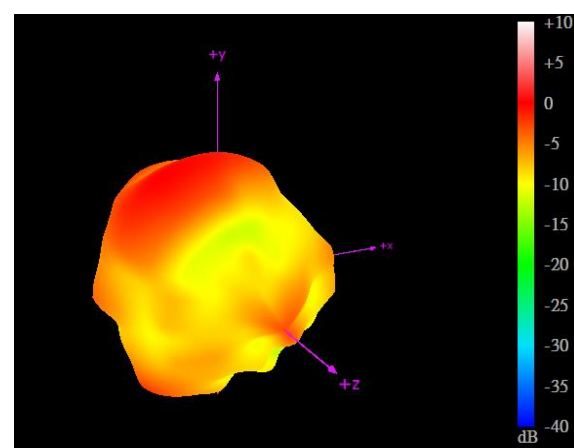

3500MHz

3.1.21 Test Setup for Antenna Radiation Pattern

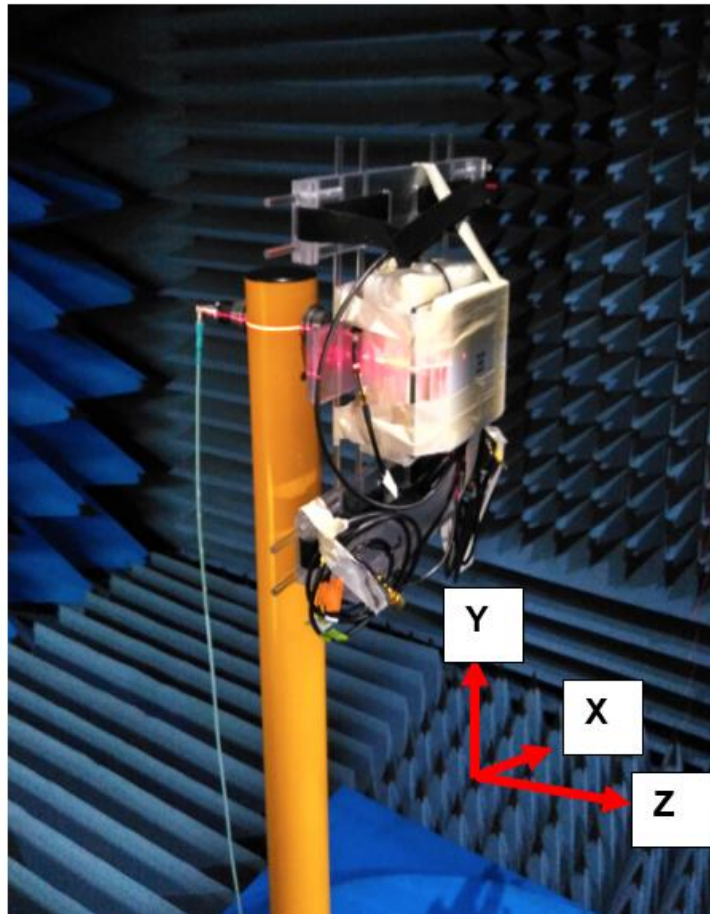

On the glass

3.1.22 2D Radiation Patterns (LTE_MIMO1 with 3M cable length on the glass)

XY Plane

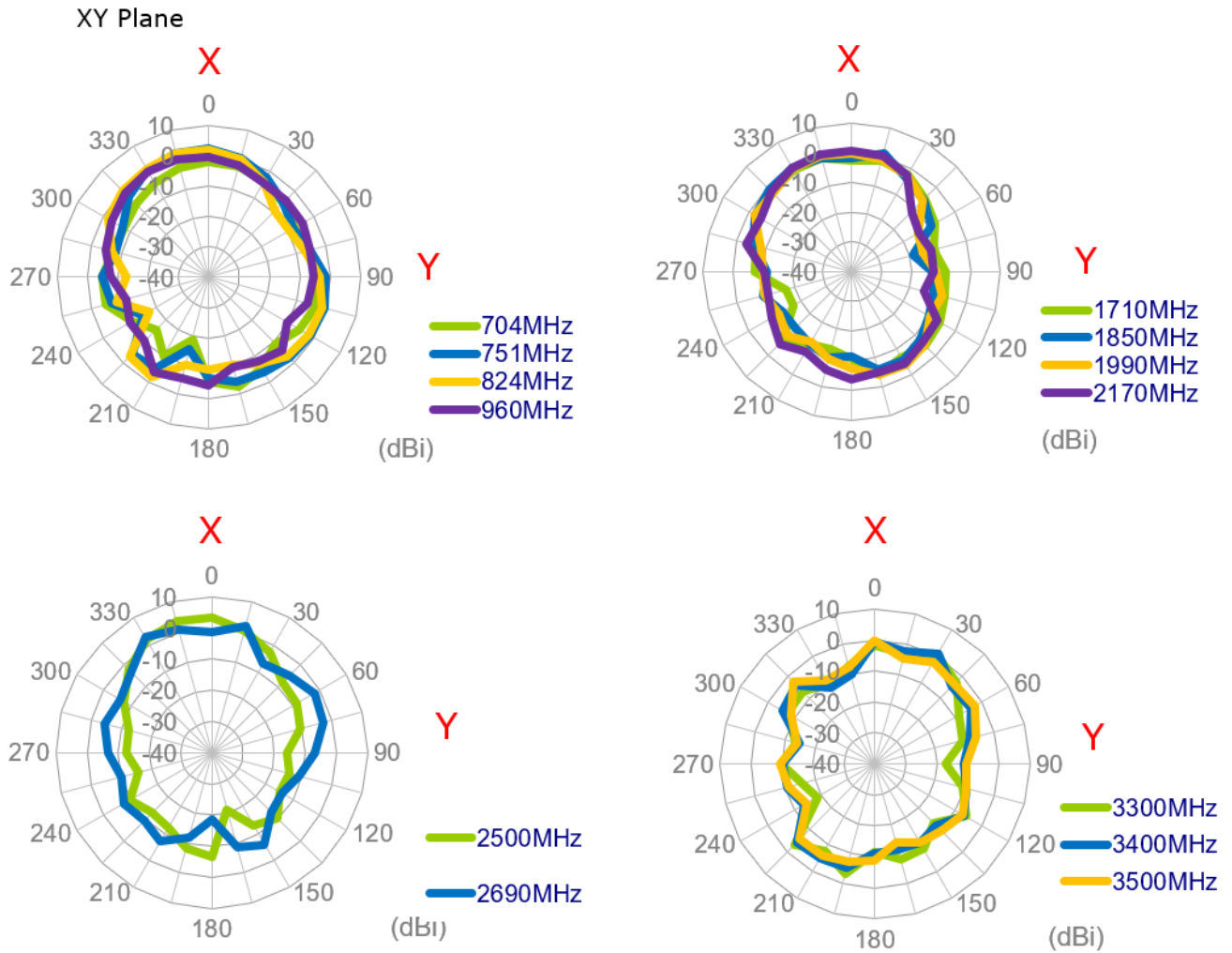

XZ Plane

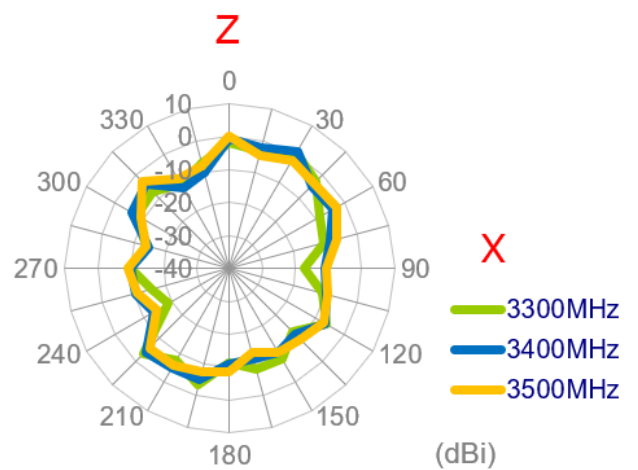
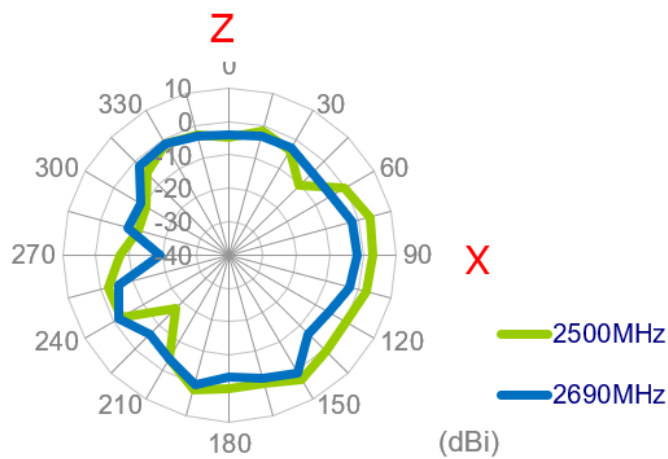
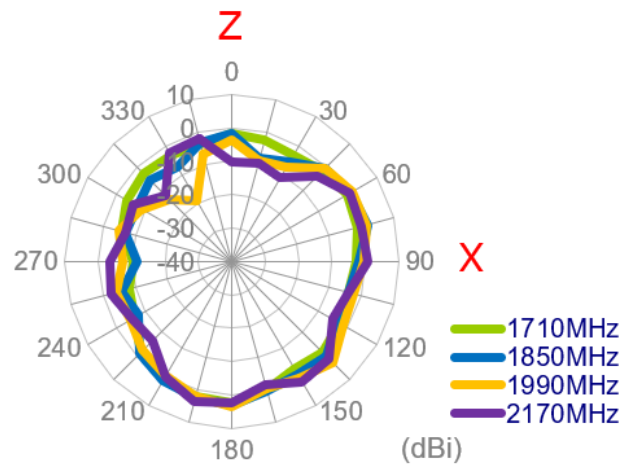
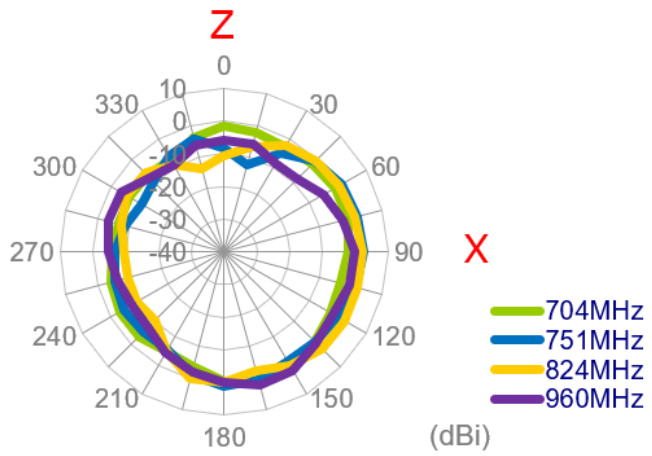

ZY Plane

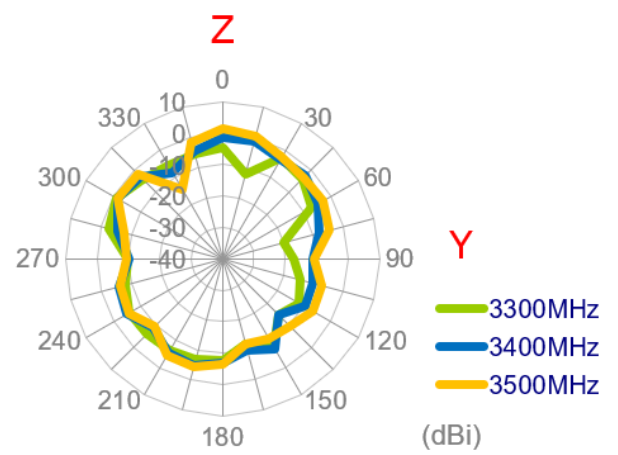
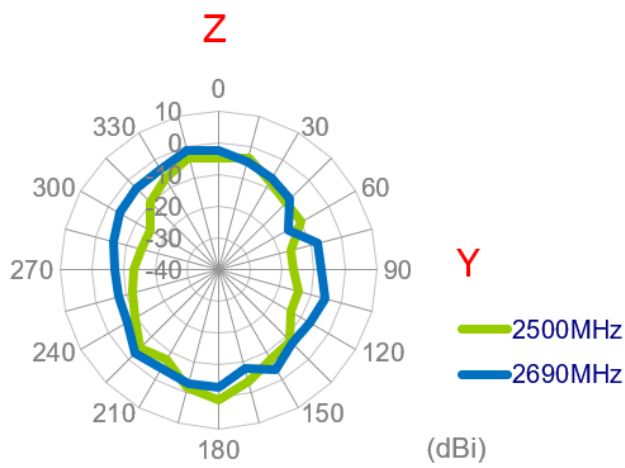
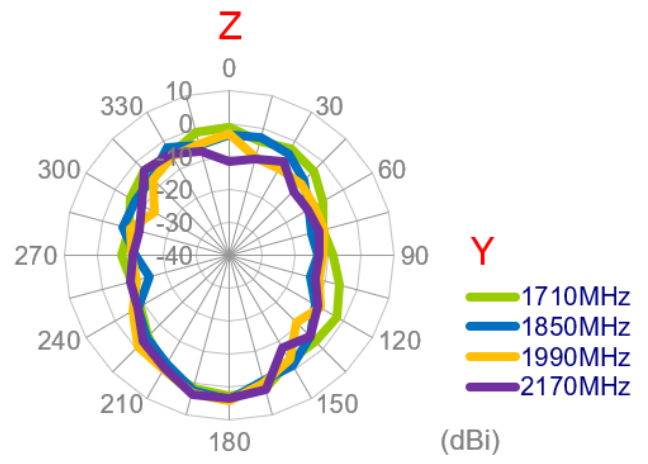
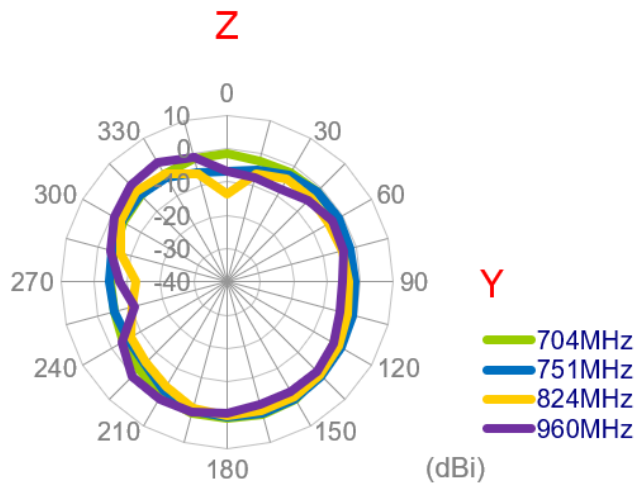

3.1.23 3D Radiation Patterns (LTE_MIMO1 with 3m cable length on the glass)

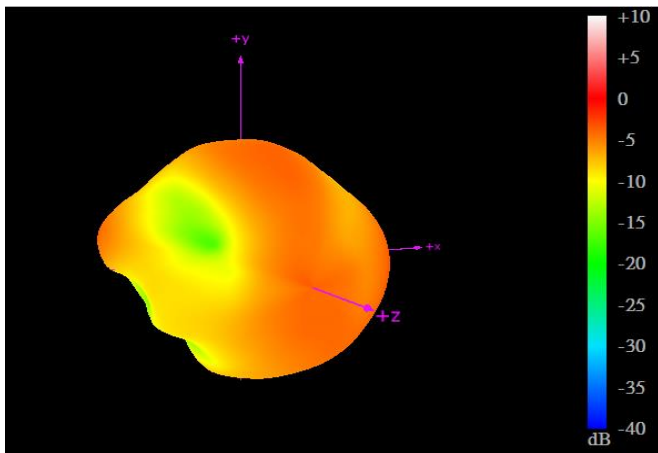

704MHz

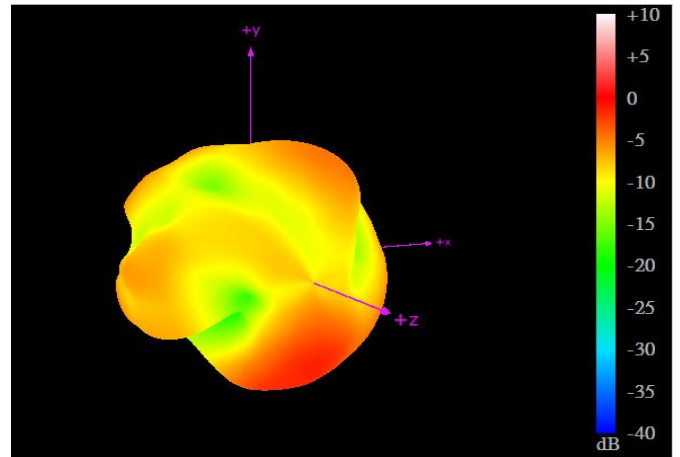

960MHz

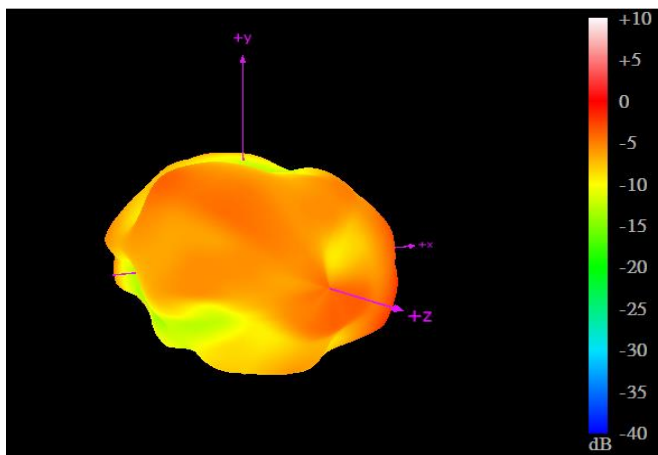

1710MHz

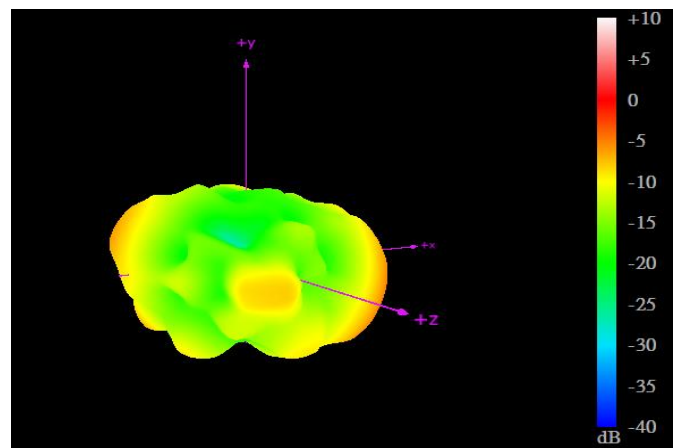

2170MHz

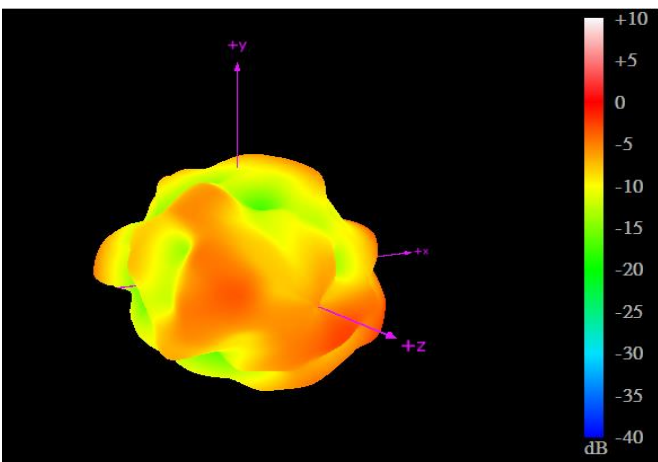

2690MHz

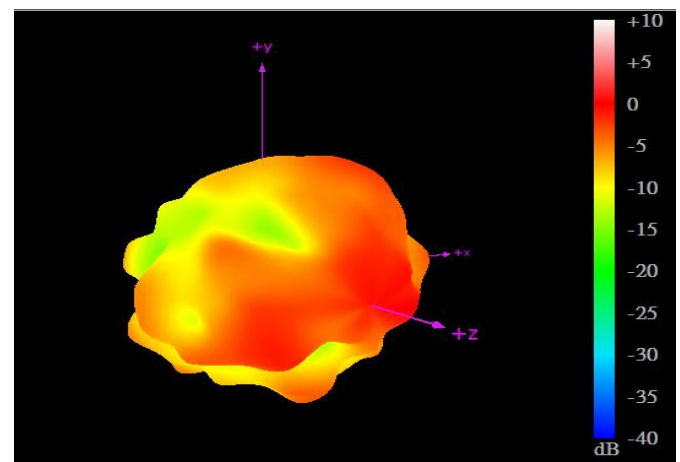

3500MHz

3.1.24 2D Radiation Patterns (LTE_MIMO2 with 3m cable length on the glass)

XY Plane

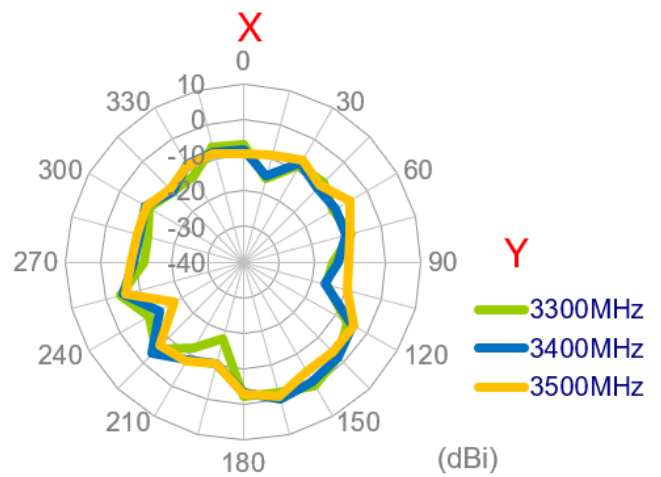
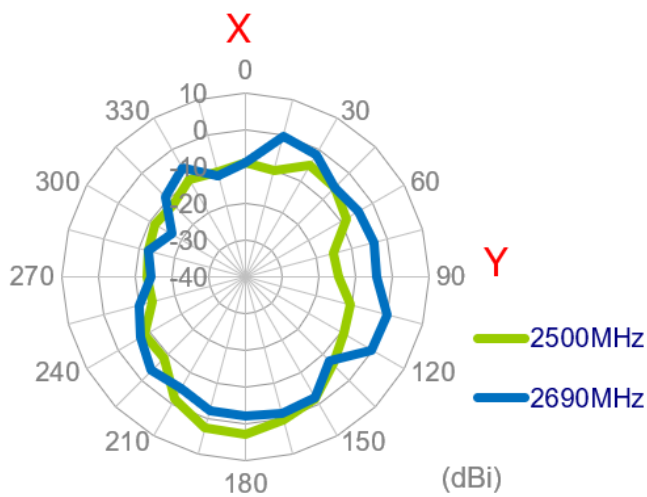
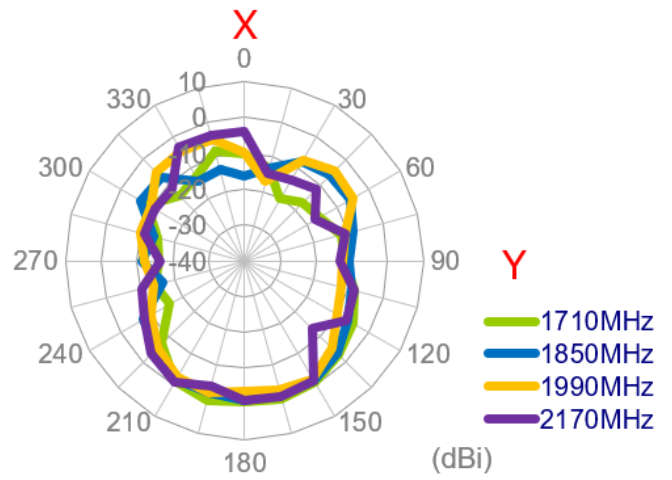
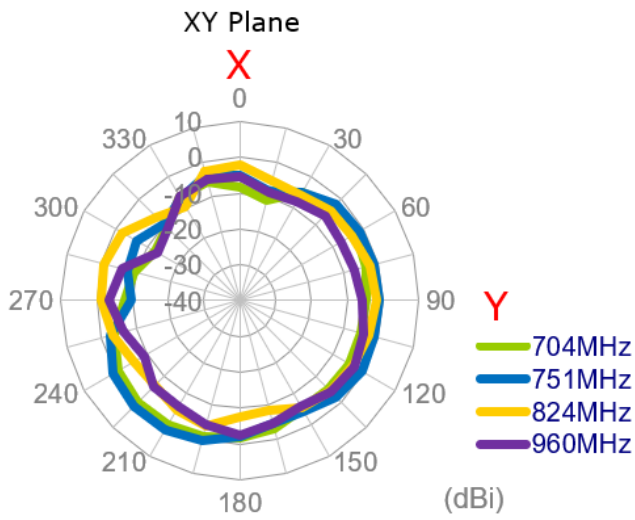

XZ Plane

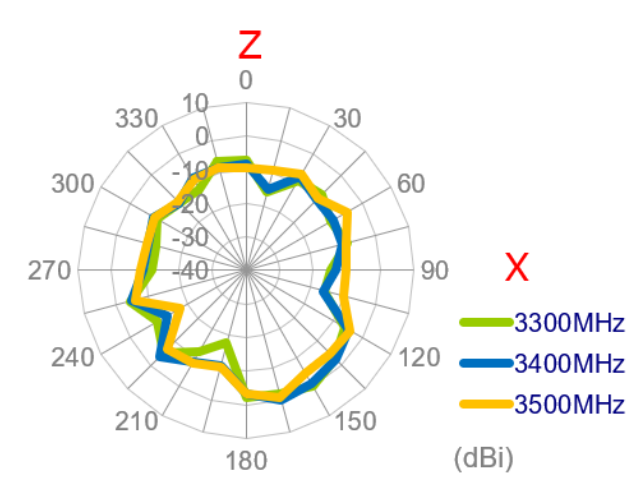
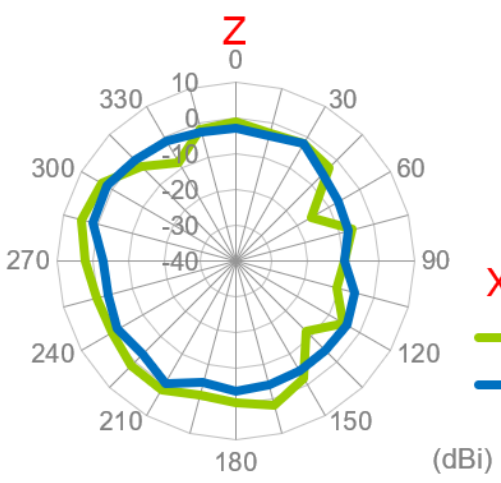
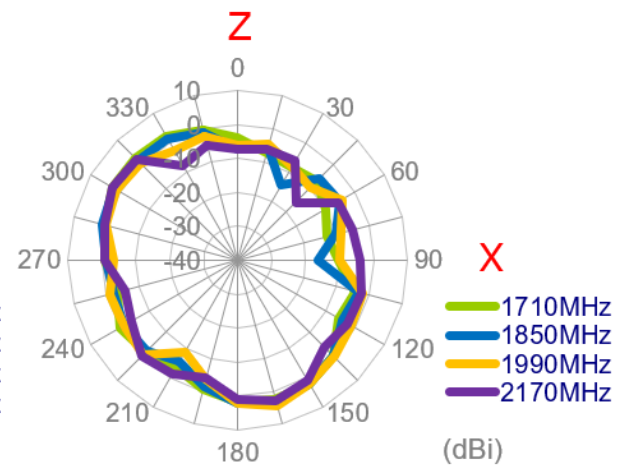
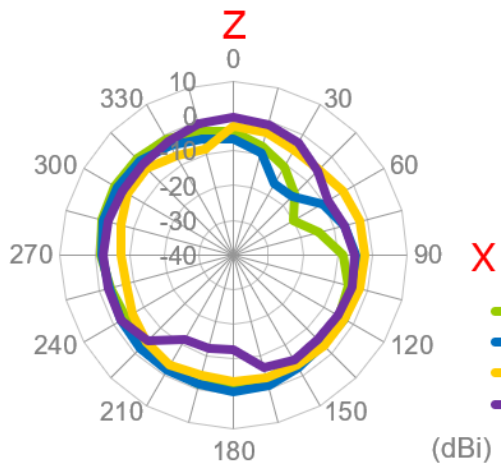

ZY Plane

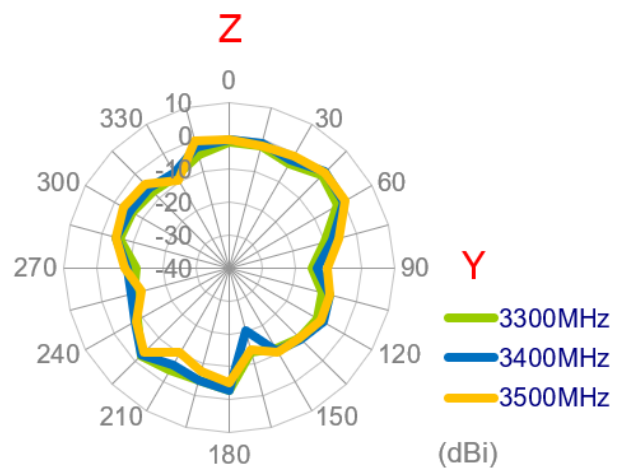
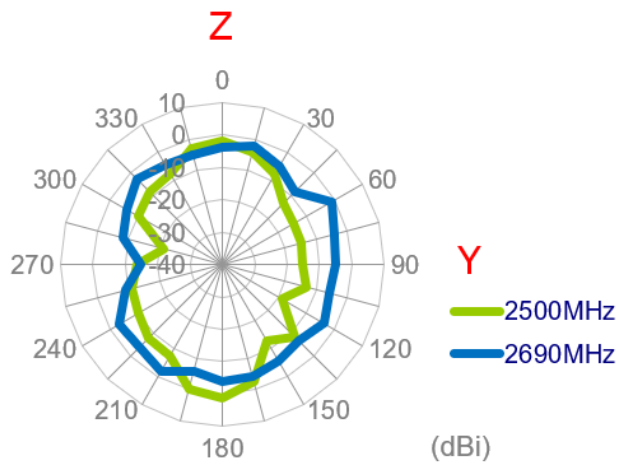
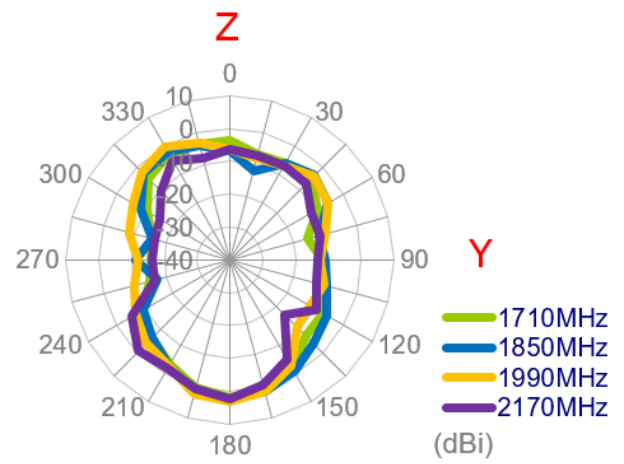
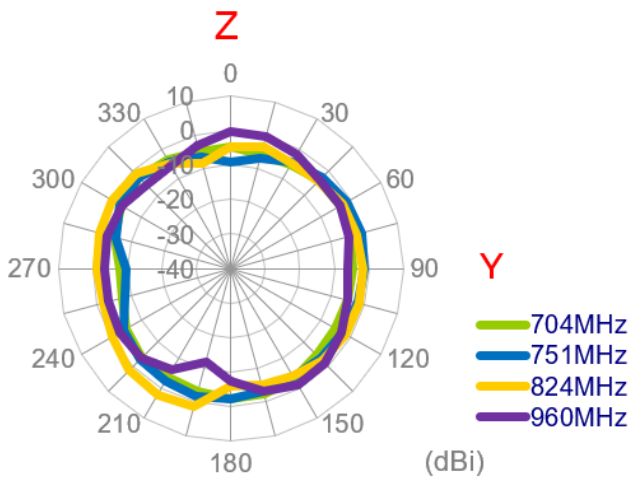

3.1.25 3D Radiation Patterns (LTE_MIMO2 with 3m cable length on the glass)

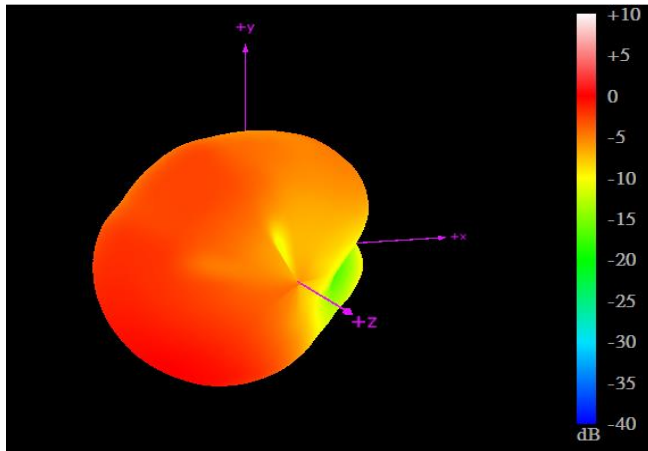

704MHz

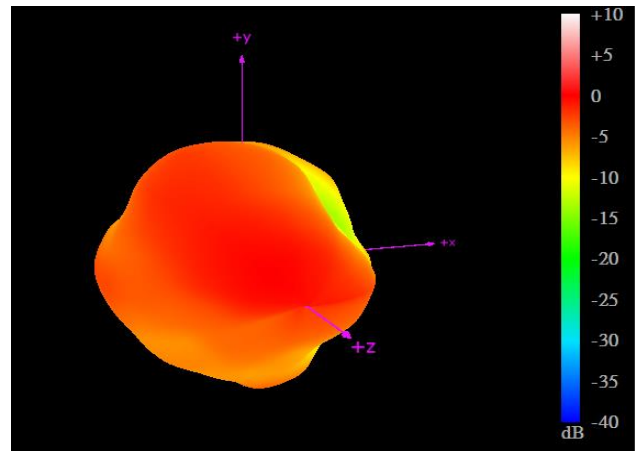

960MHz

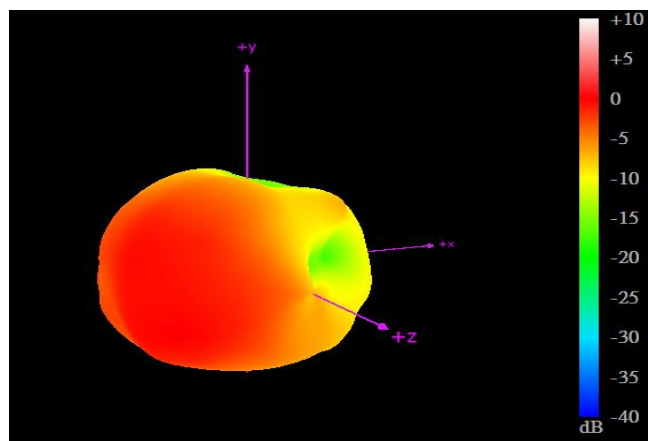

1710MHz

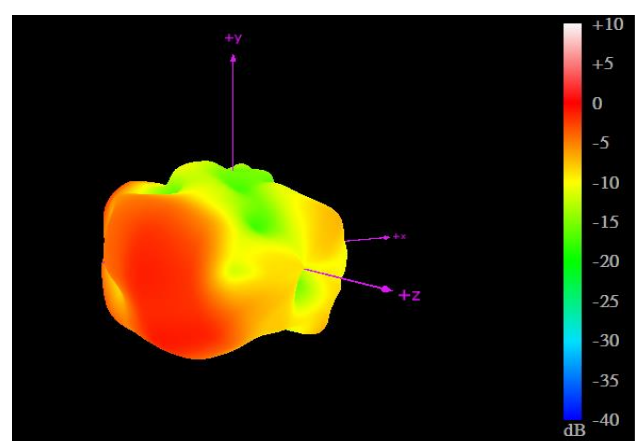

2170MHz

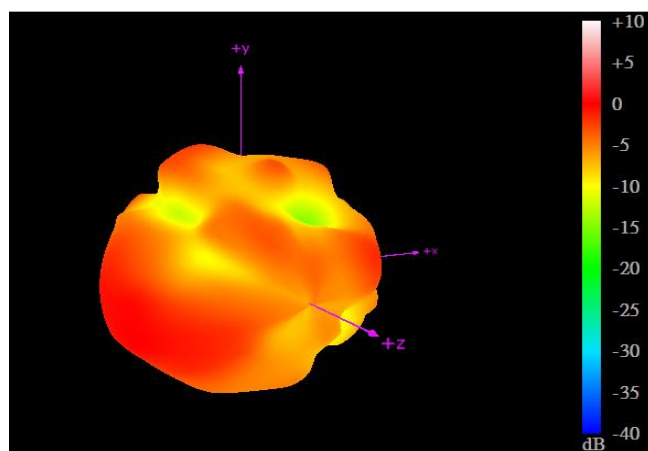

2690MHz

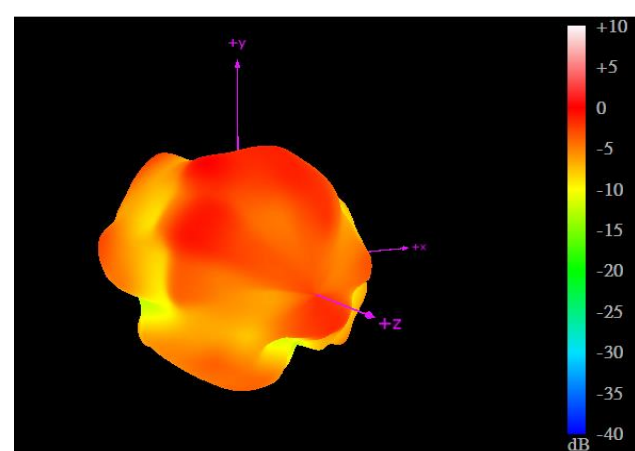

3500MHz

3.1.26 Test Setup for Antenna Radiation Pattern

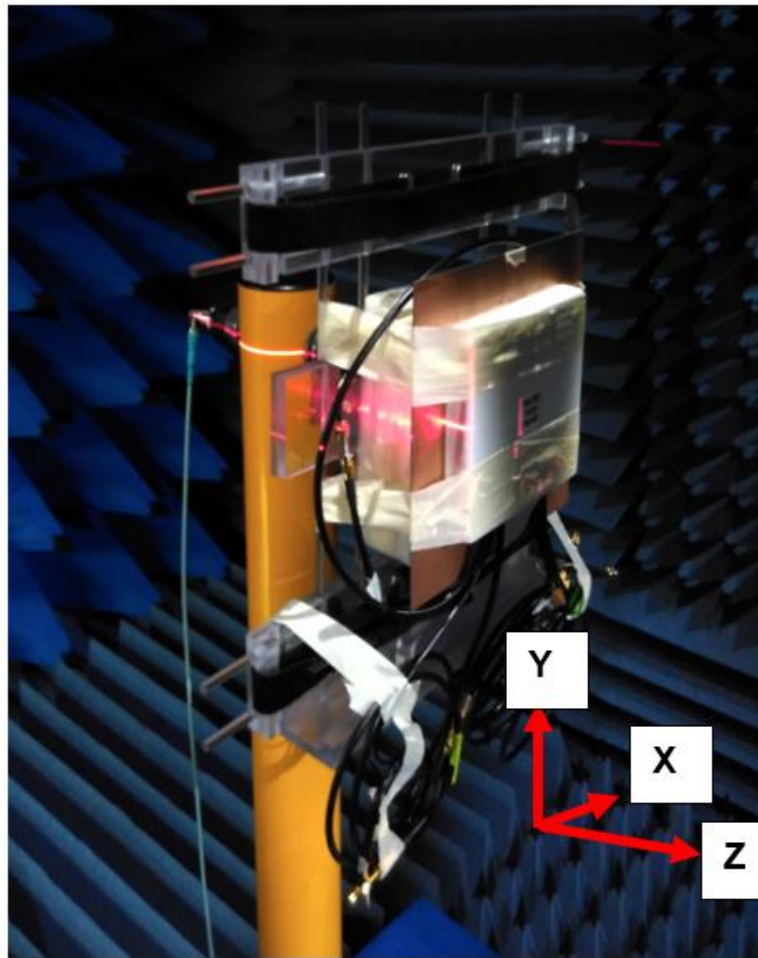

On the metal

3.1.27 2D Radiation Patterns (LTE_MIMO1 with 3M cable length on the metal)

XY Plane

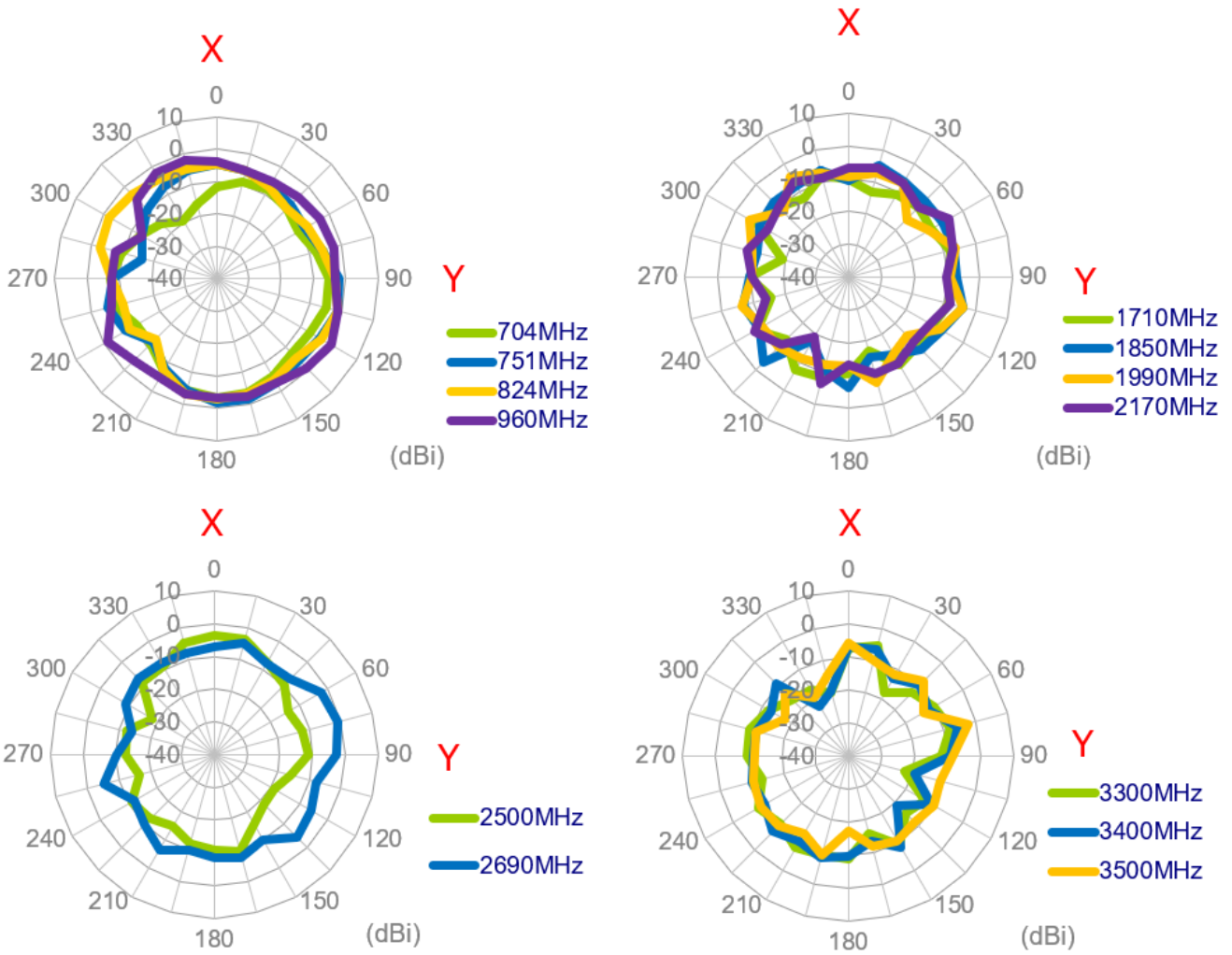

XZ Plane

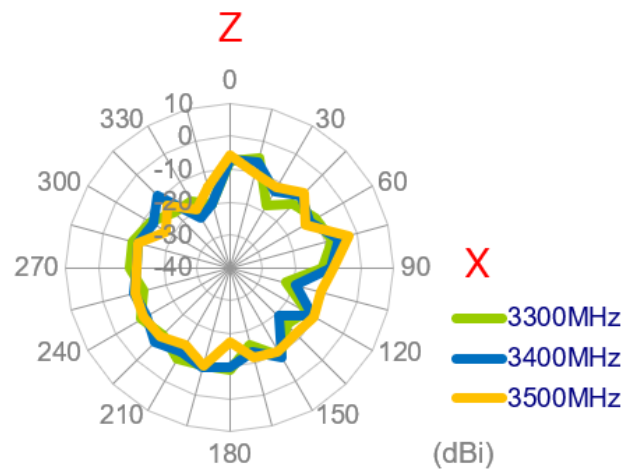
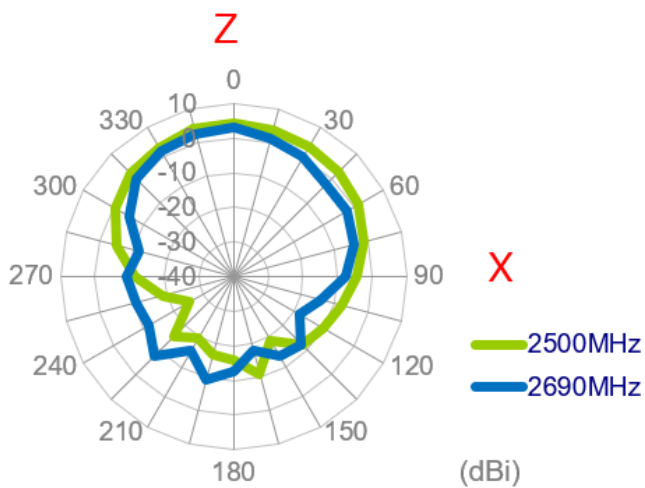
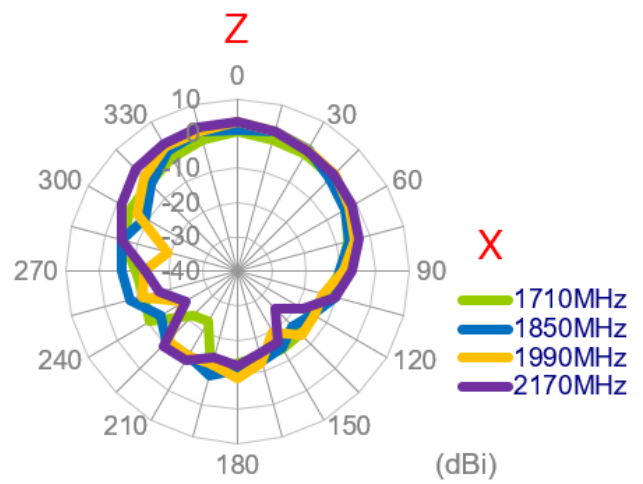
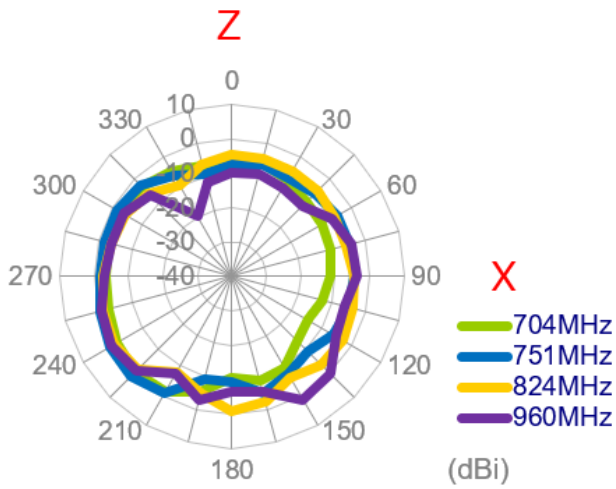

ZY Plane

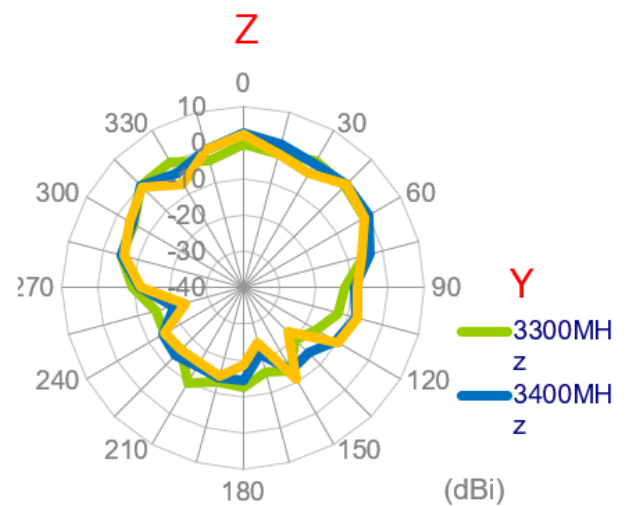
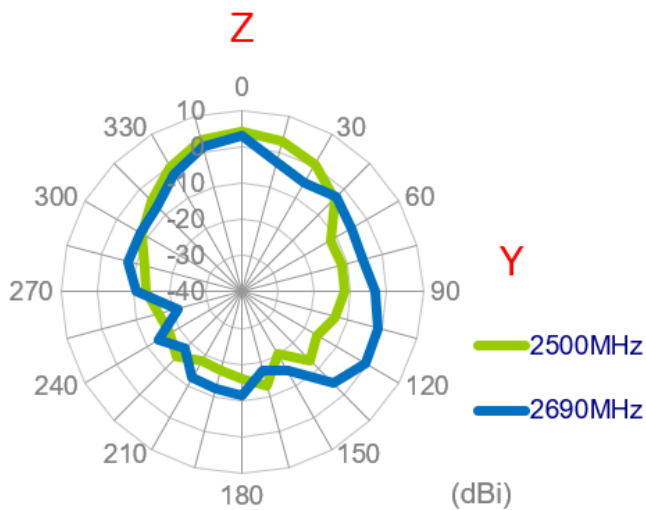
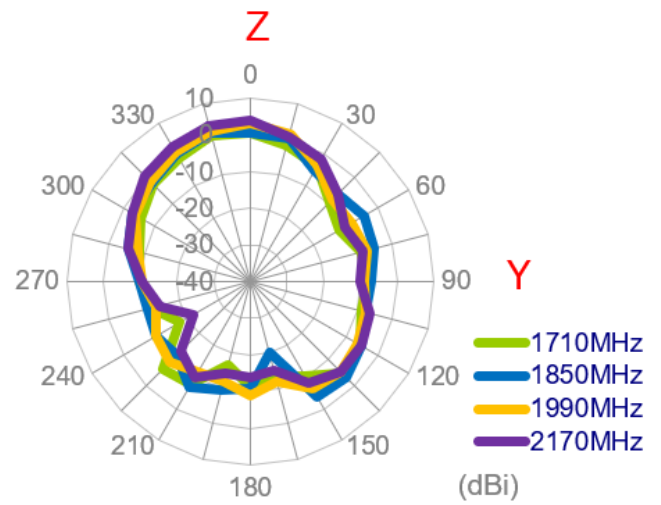
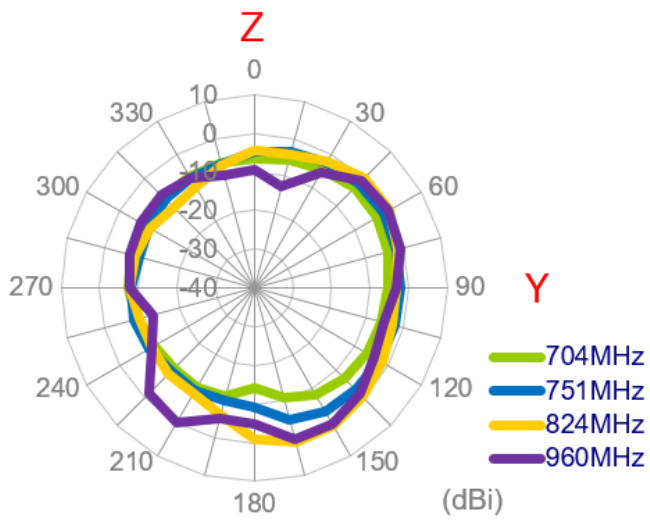

3.1.28 3D Radiation Patterns (LTE_MIMO1 with 3m cable length on the metal)

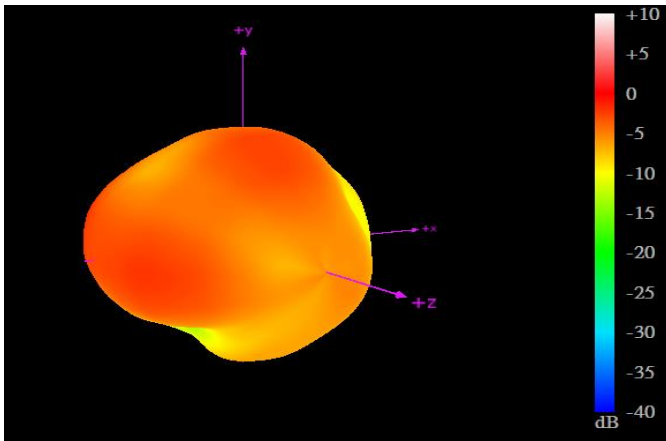

704MHz

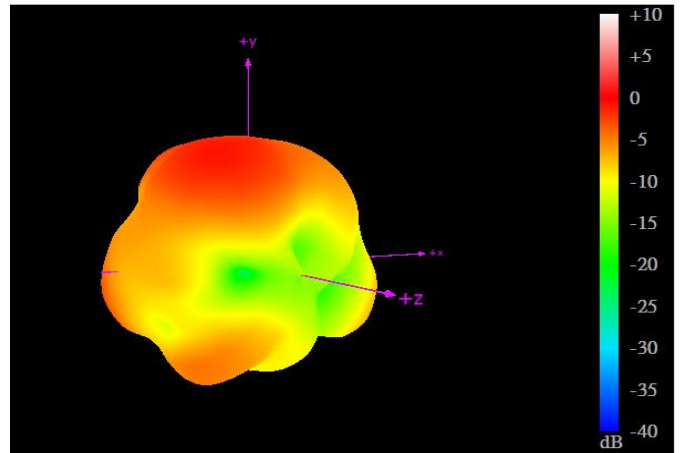

960MHz

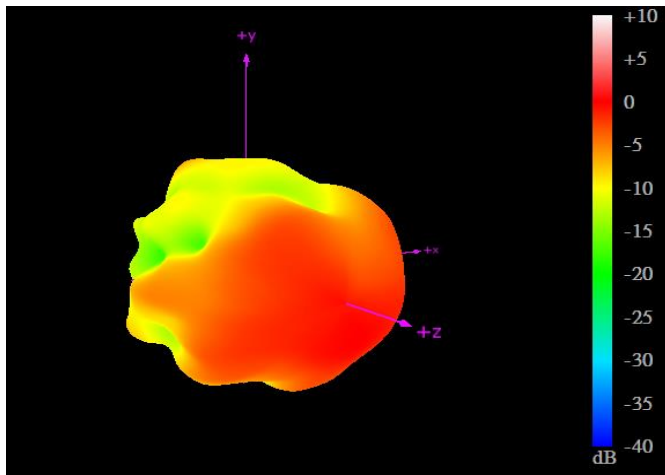

1710MHz

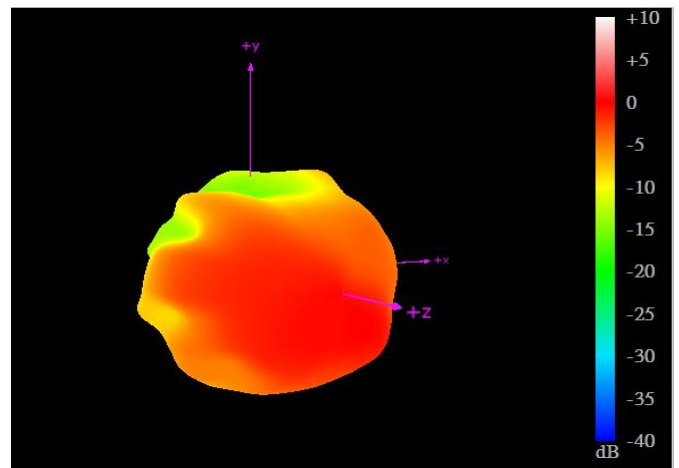

2170MHz

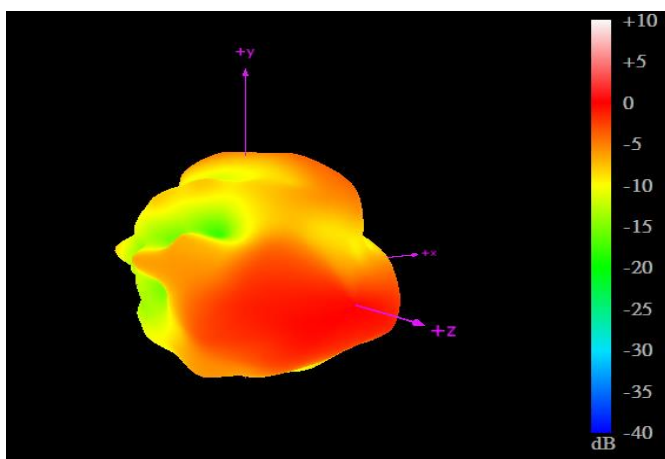

2690MHz

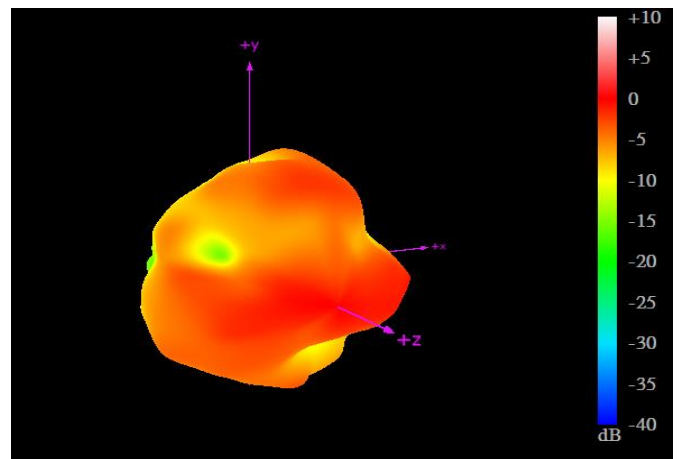

3500MHz

3.1.29 2D Radiation Patterns (LTE_MIMO2 with 3m cable length on the metal)

XY Plane

XY Plane

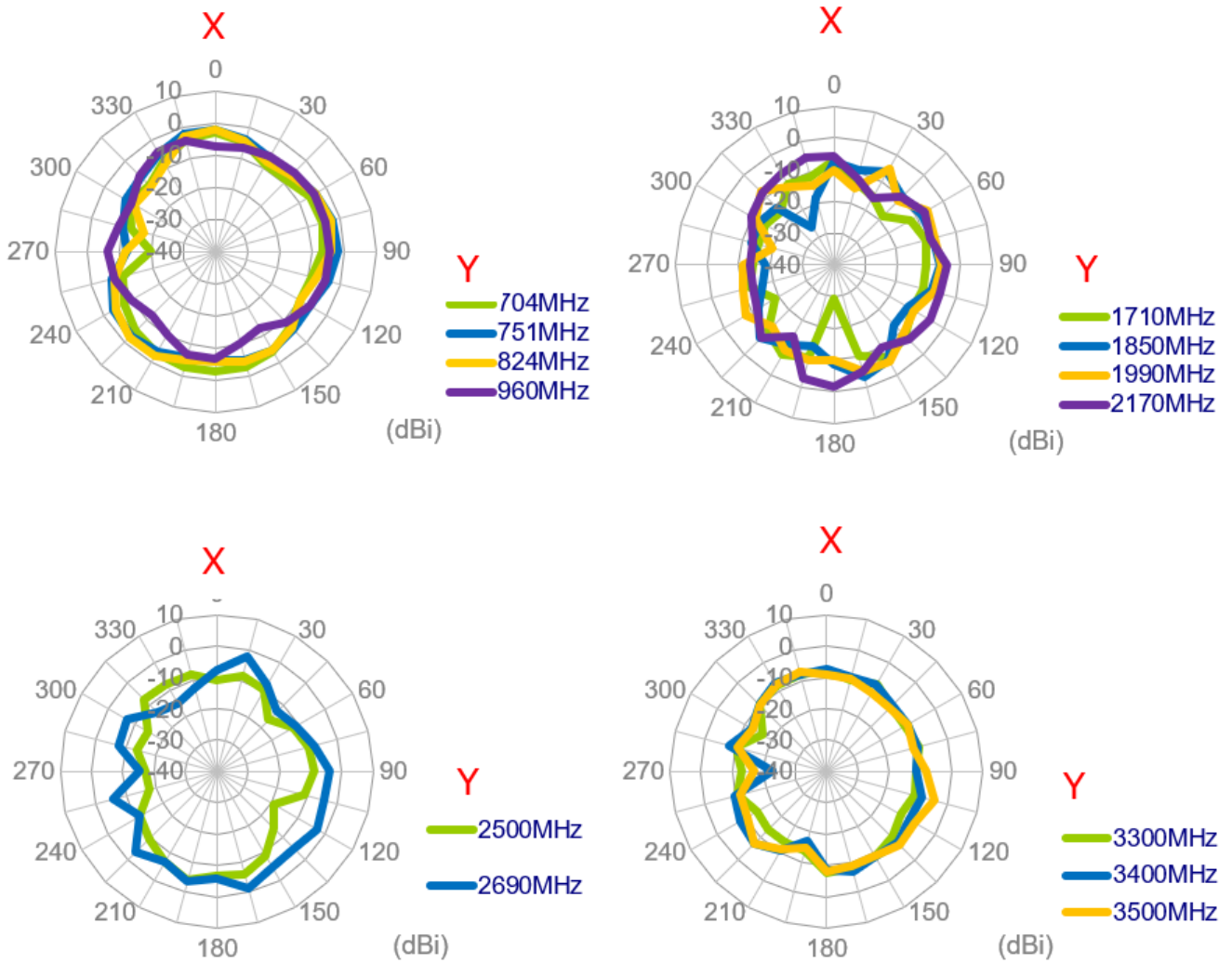

XZ Plane

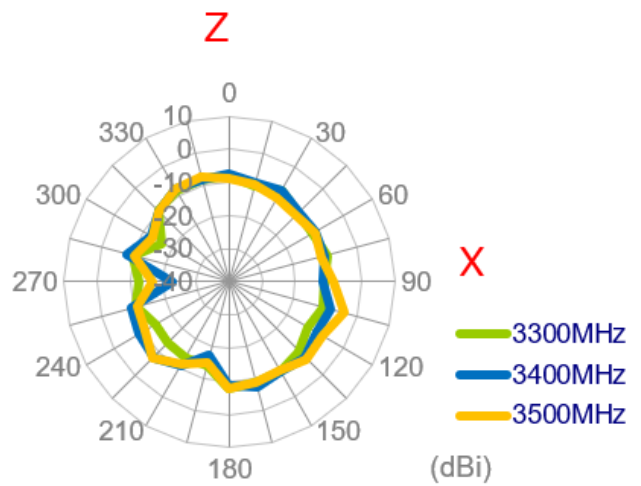
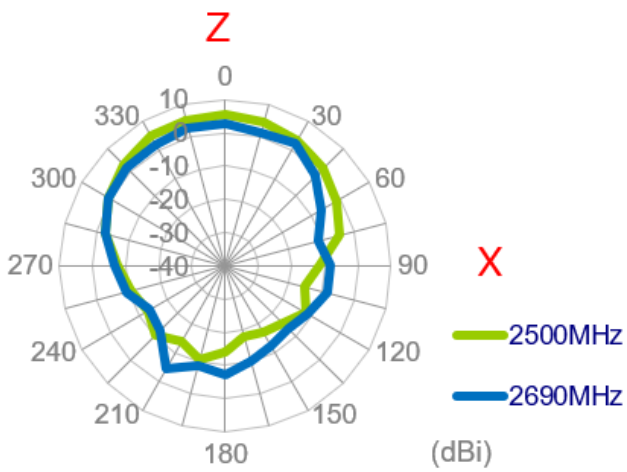
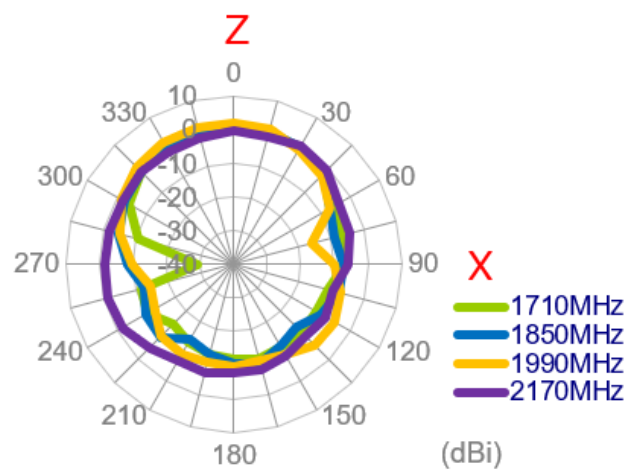
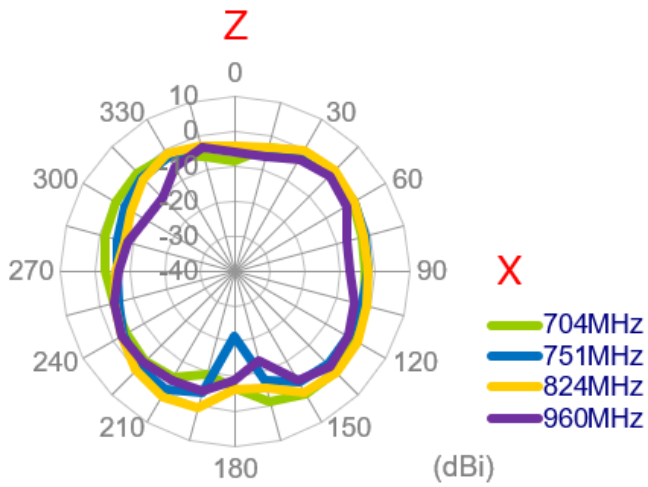

ZY Plane

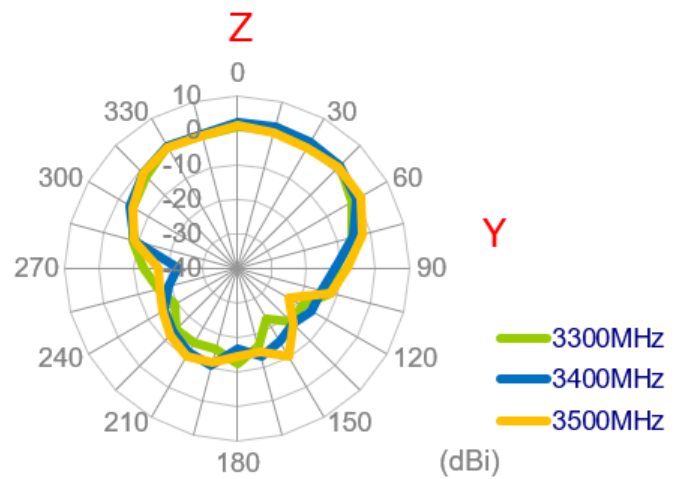
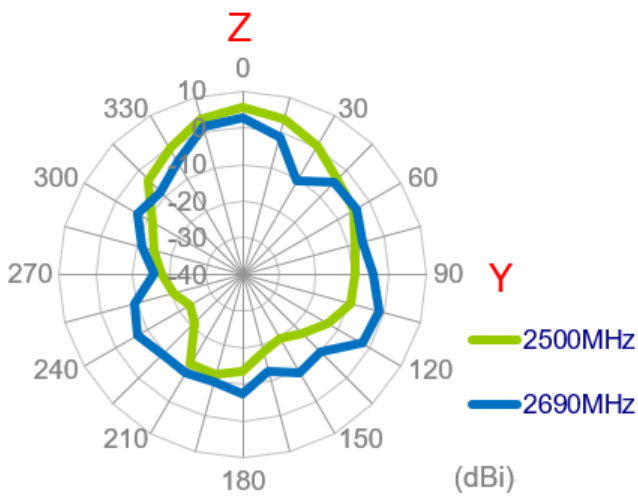
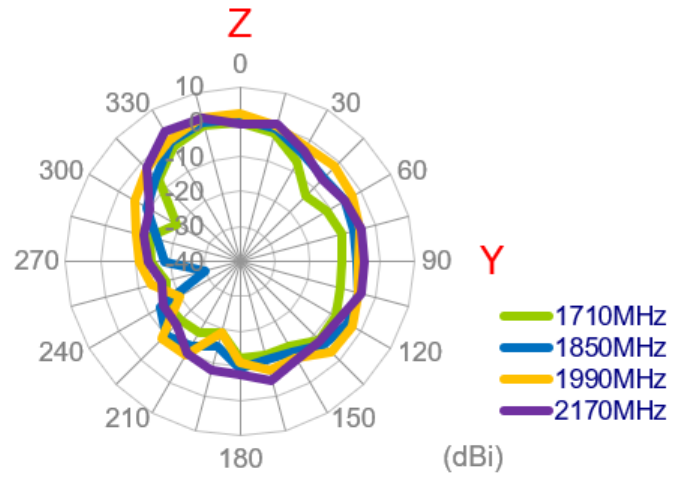
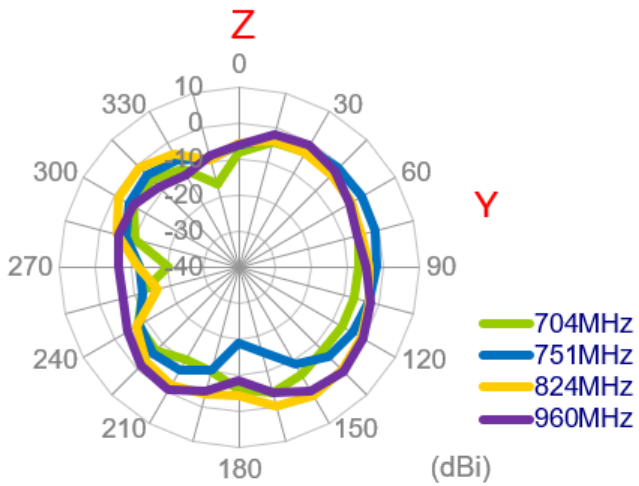

3.1.30 3D Radiation Patterns (LTE_MIMO2 with 3m cable length on the metal)

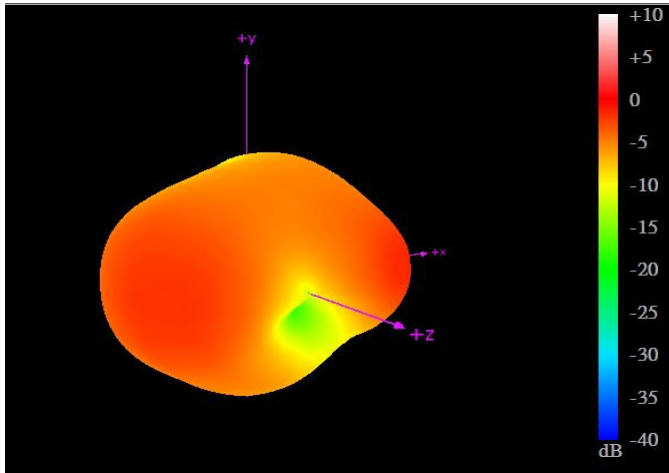

704MHz

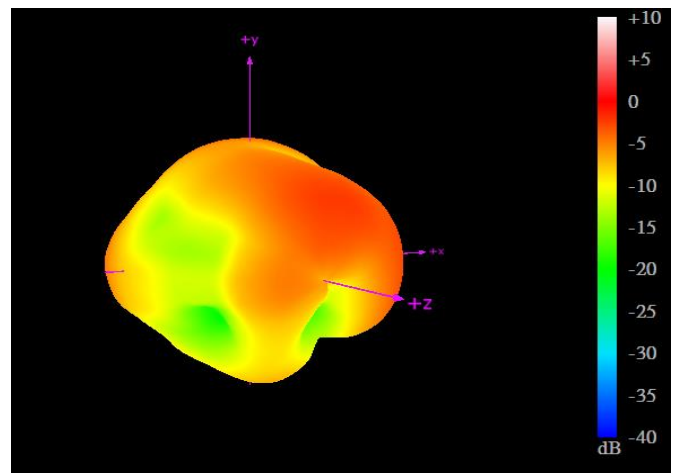

960MHz

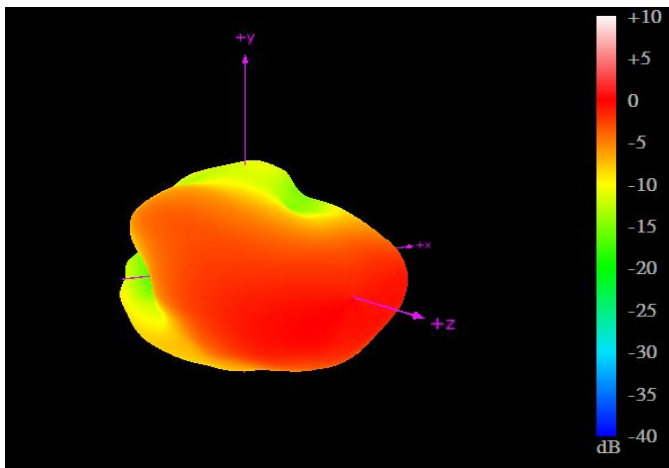

1710MHz

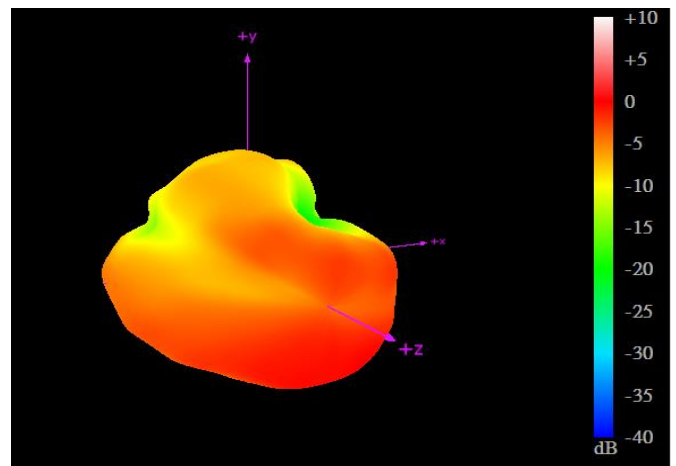

2170MHz

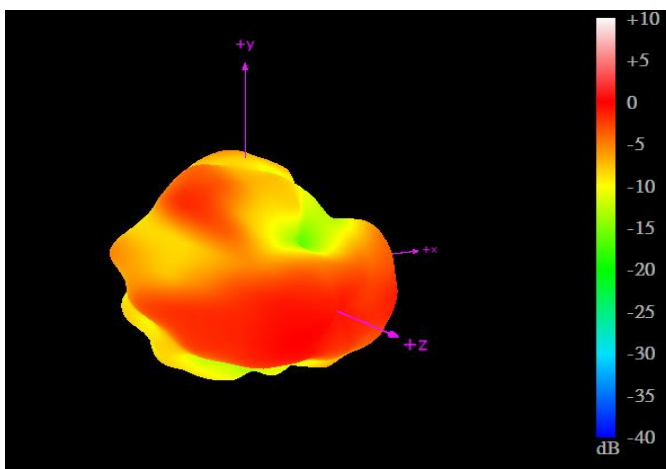

2690MHz

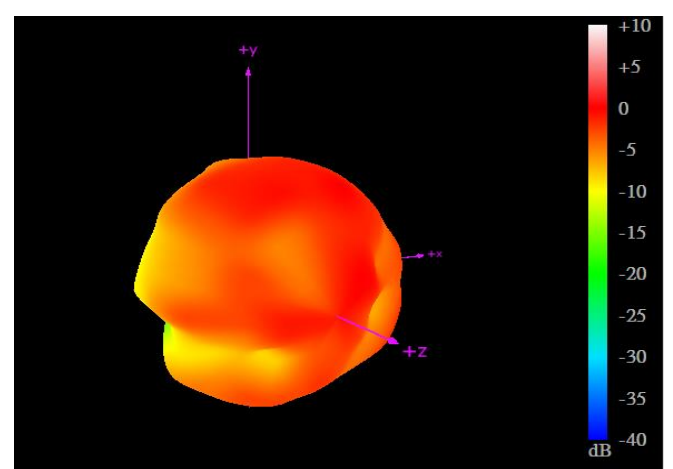

3500MHz

3.1.31 Test Setup for Antenna Radiation Pattern

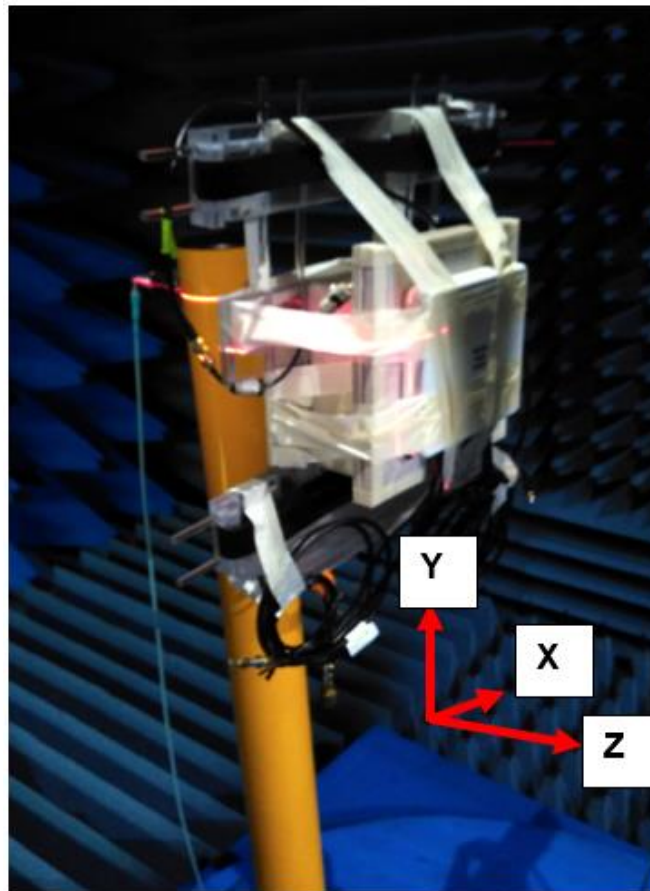

On the wall

3.1.32 2D Radiation Patterns (LTE_MIMO1 with 3M cable length on the wall)

XY Plane

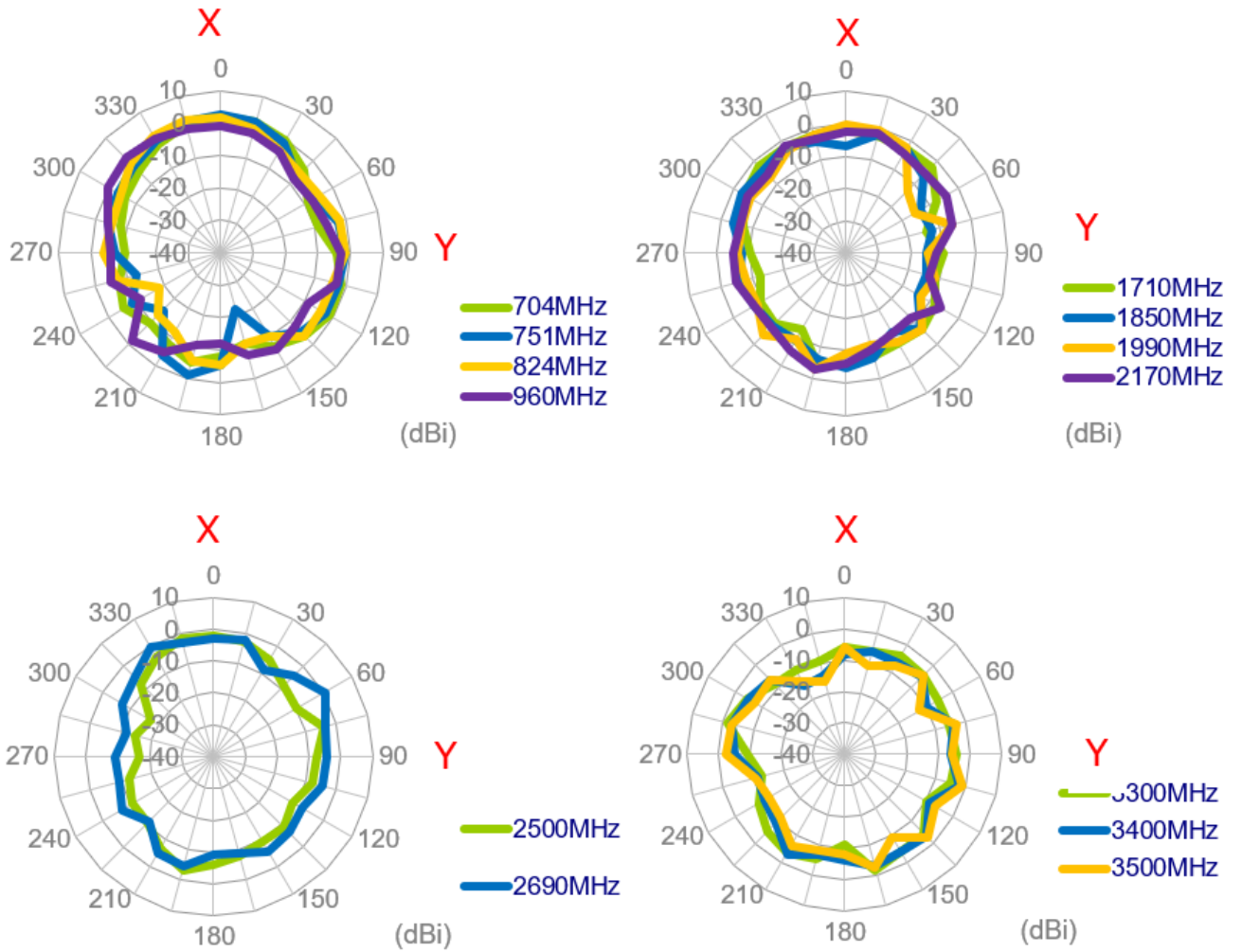

XZ Plane

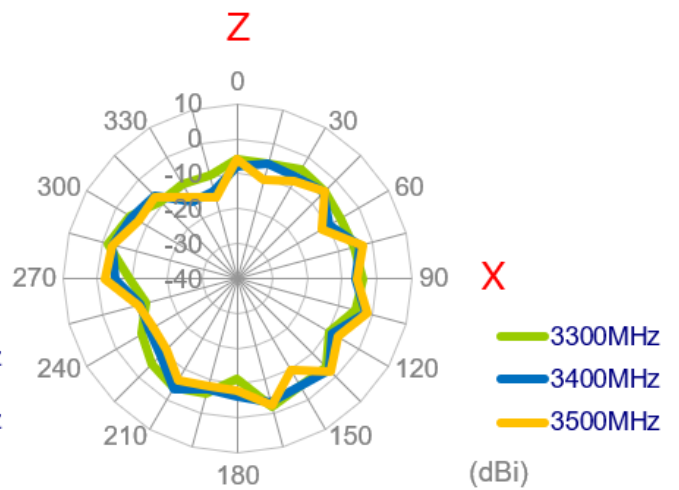
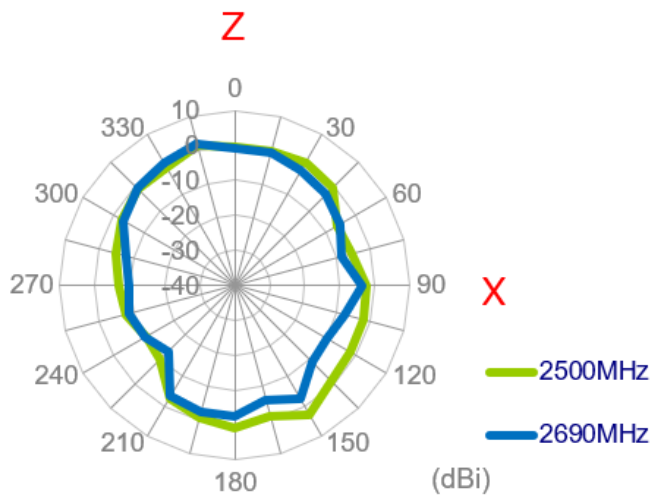
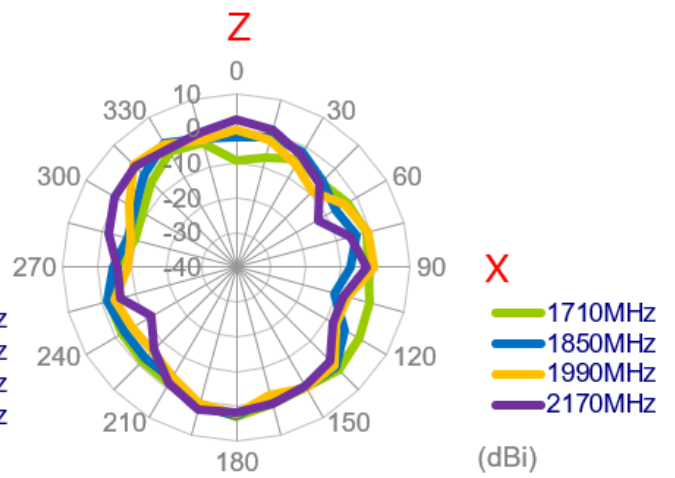
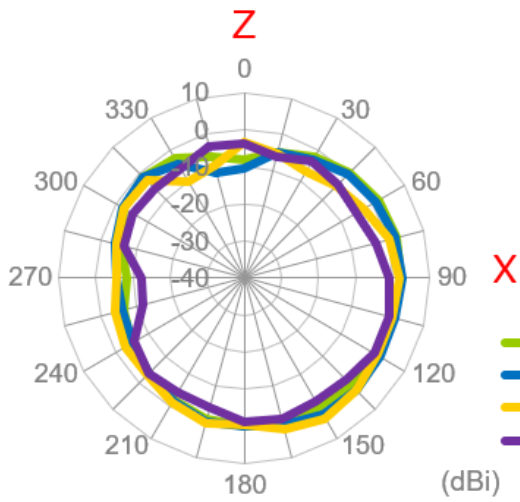

ZY Plane

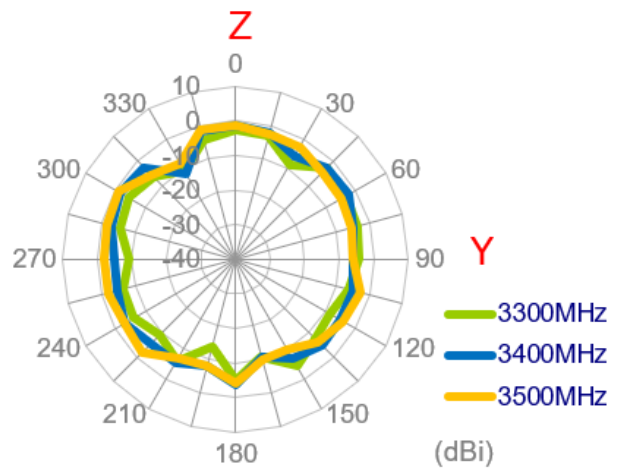
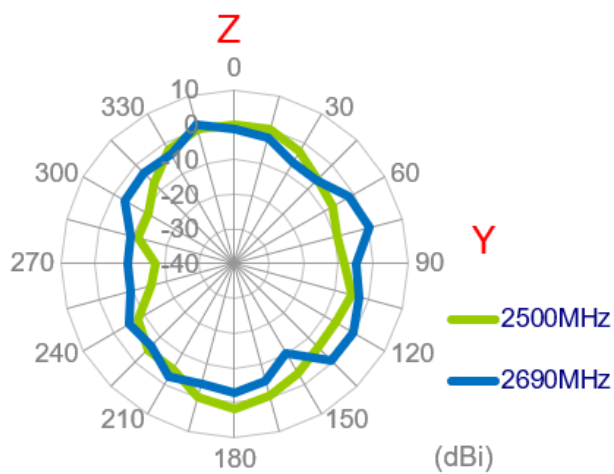
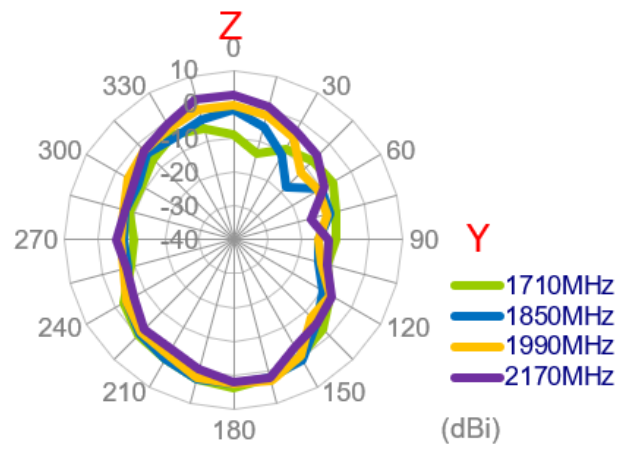
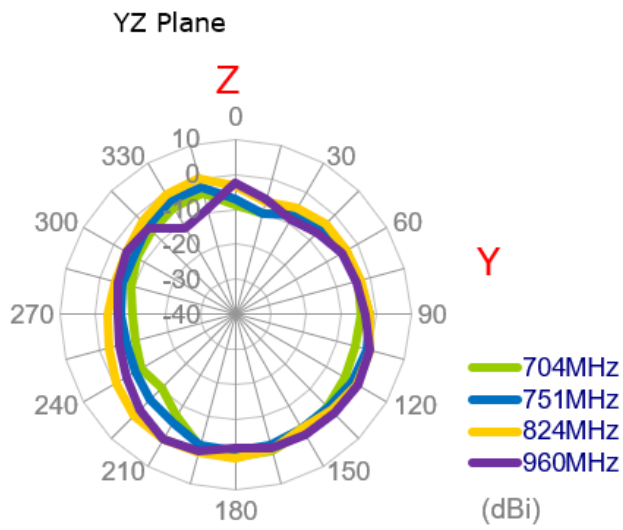

3.1.33 3D Radiation Patterns (LTE_MIMO1 with 3m cable length on the wall)

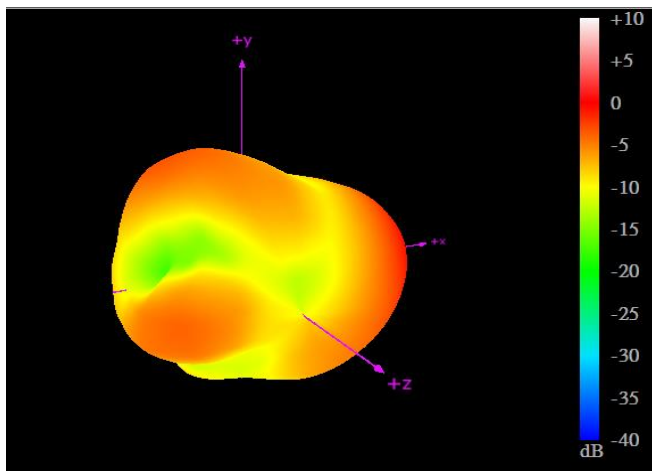

704MHz

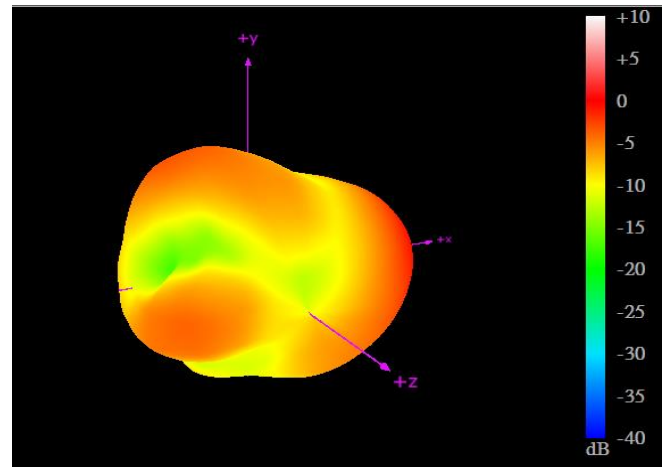

960MHz

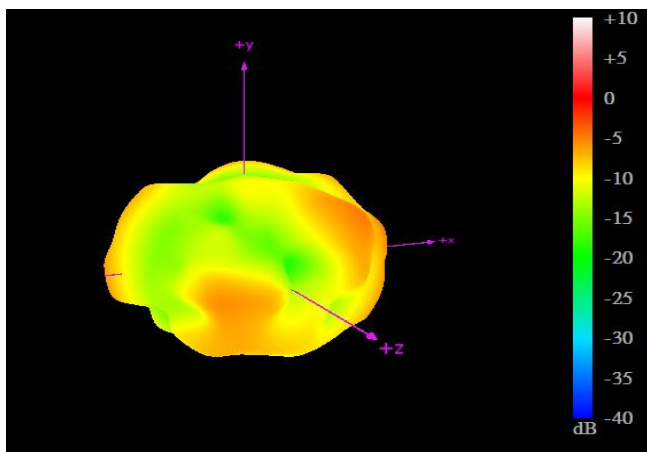

1710MHz

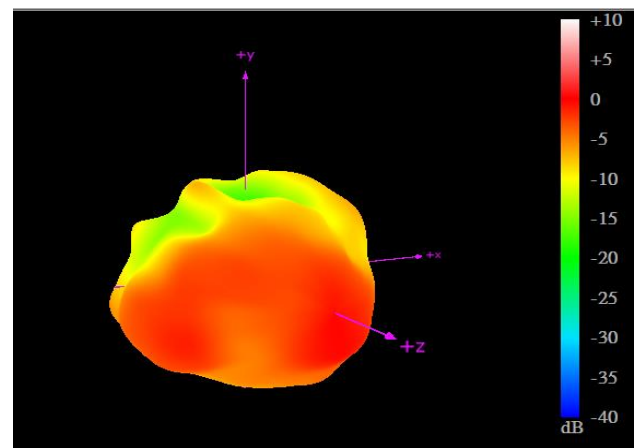

2170MHz

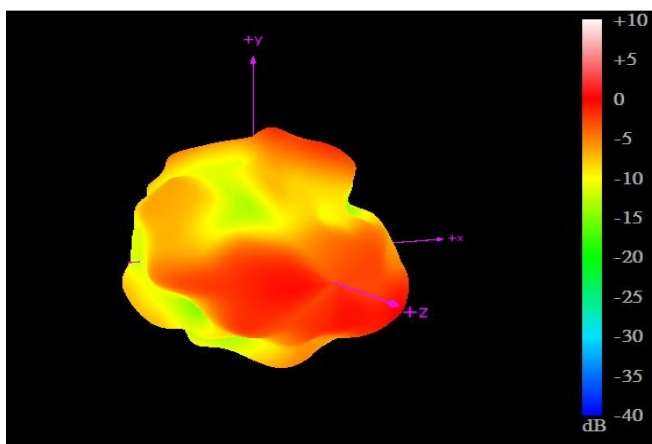

2690MHz

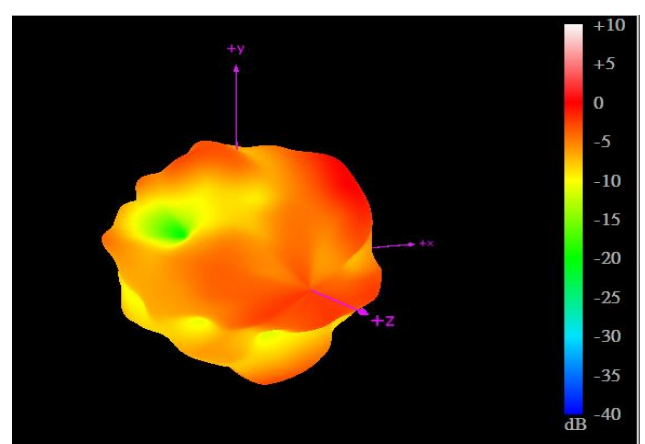

3500MHz

3.1.34 2D Radiation Patterns (LTE_MIMO2 with 3m cable length on the metal)

XY Plane

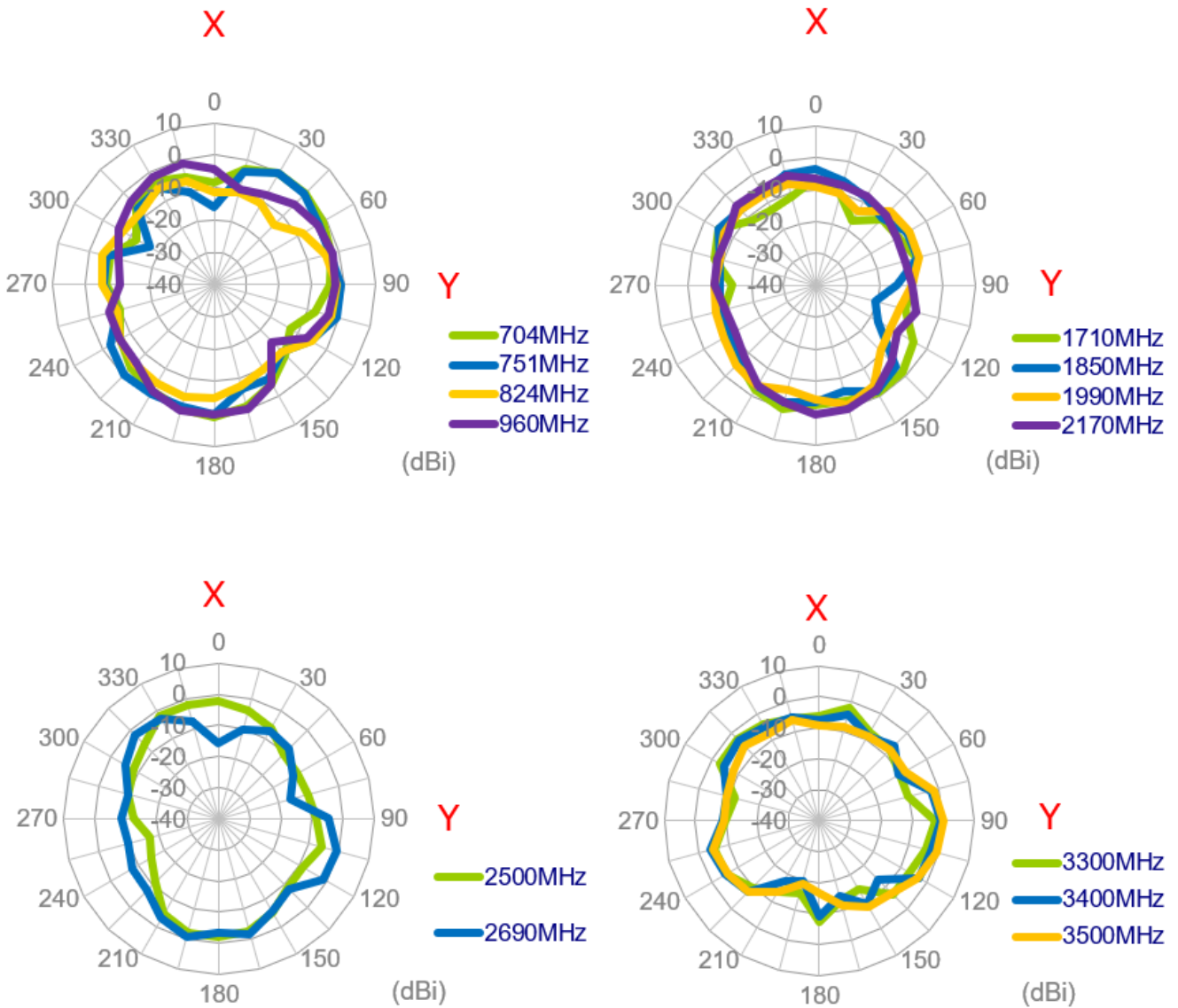

XZ Plane

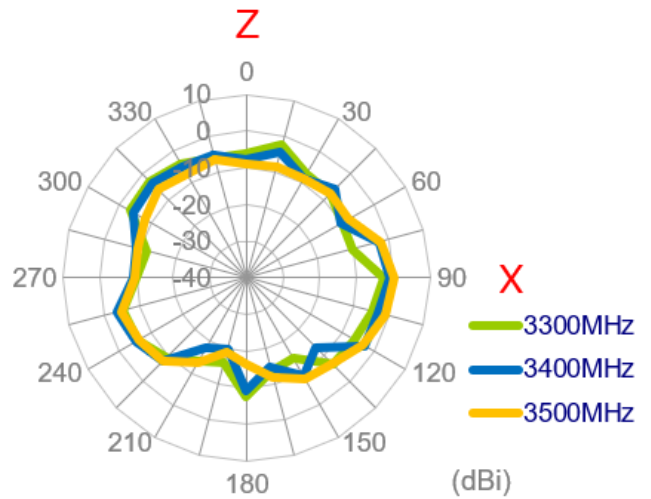
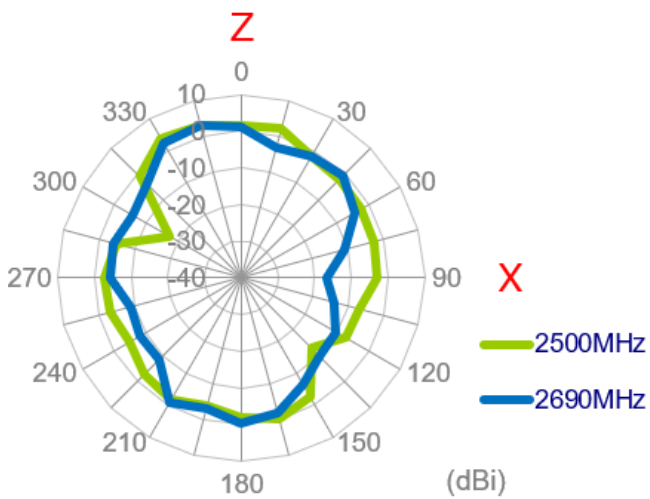
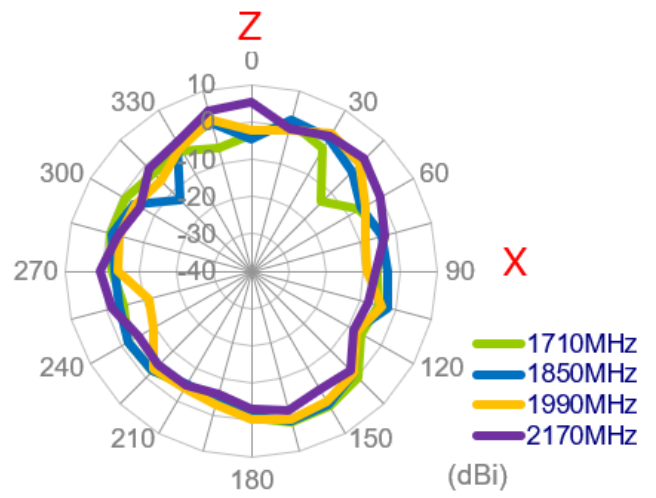
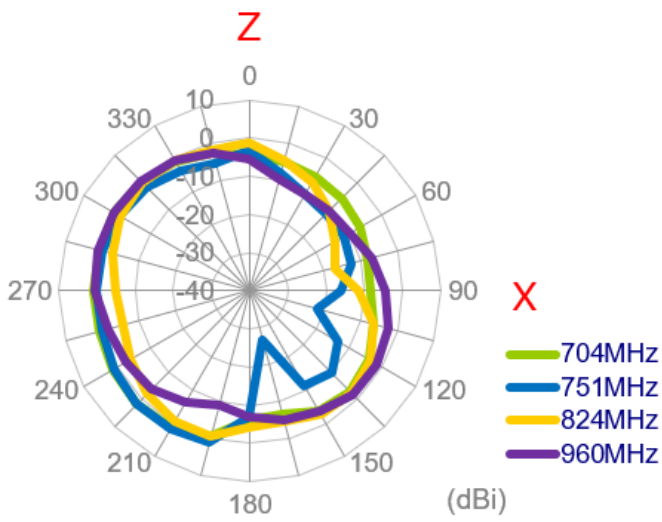

ZY Plane

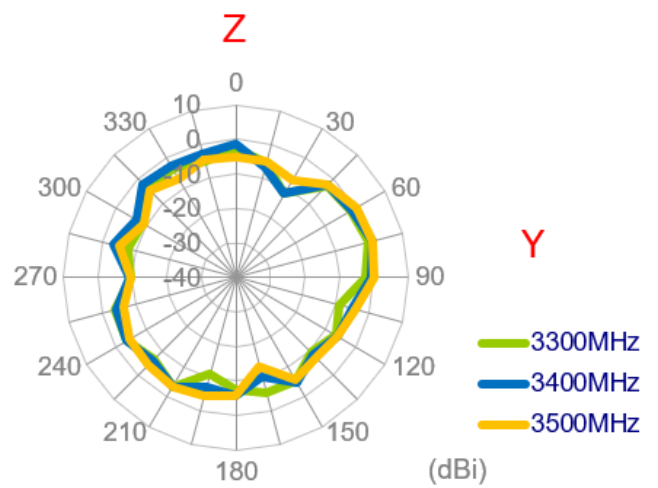
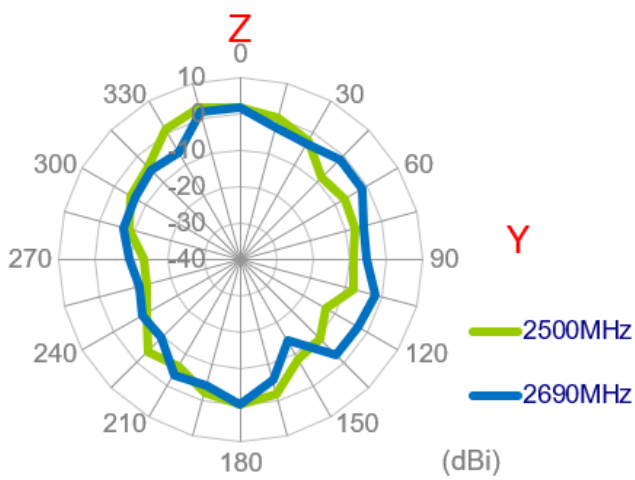
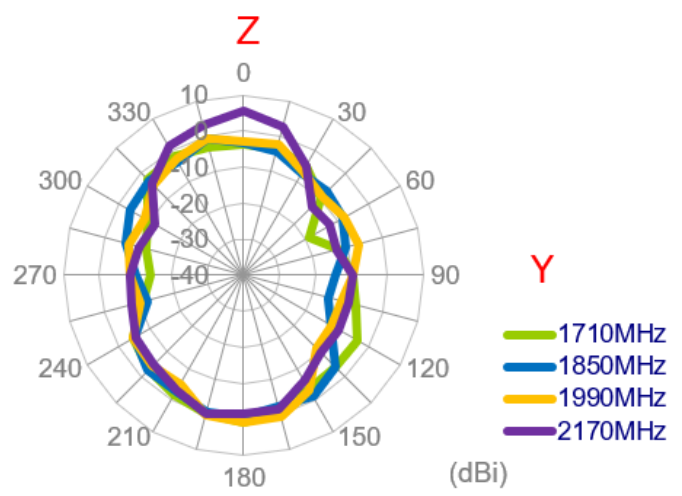
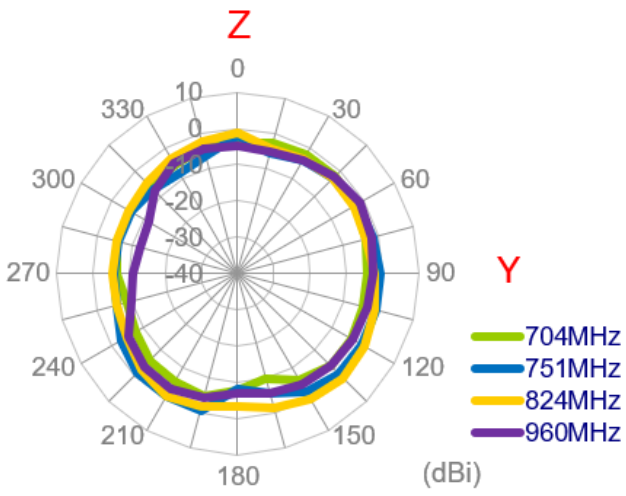

3.1.35 3D Radiation Patterns (LTE_MIMO2 with 3m cable length on the metal)

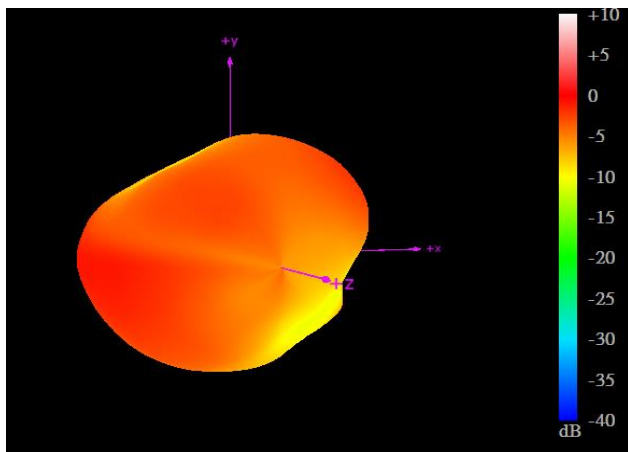

704MHz

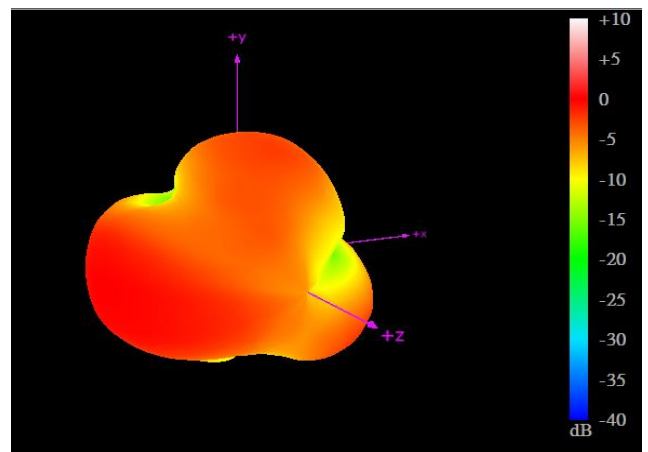

960MHz

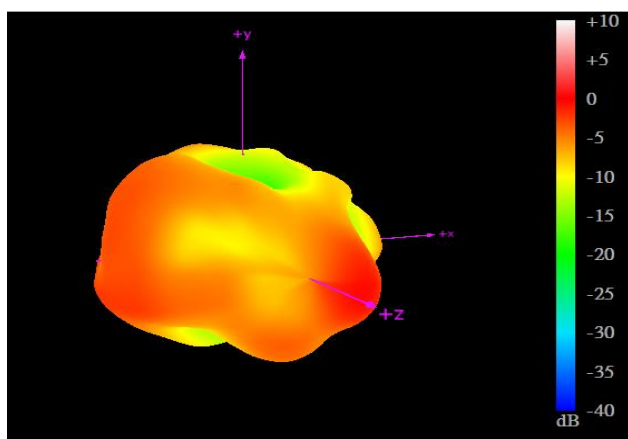

1710MHz

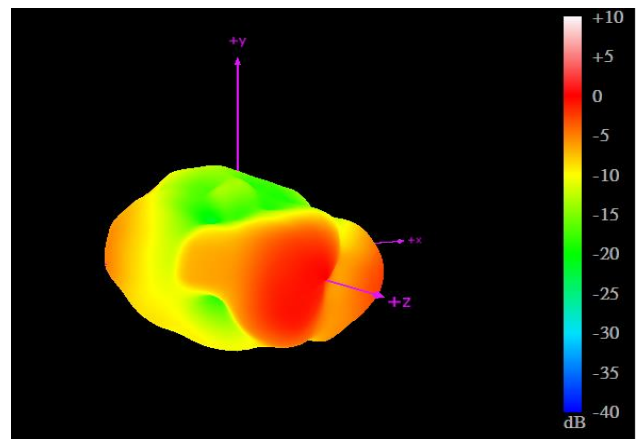

2170MHz

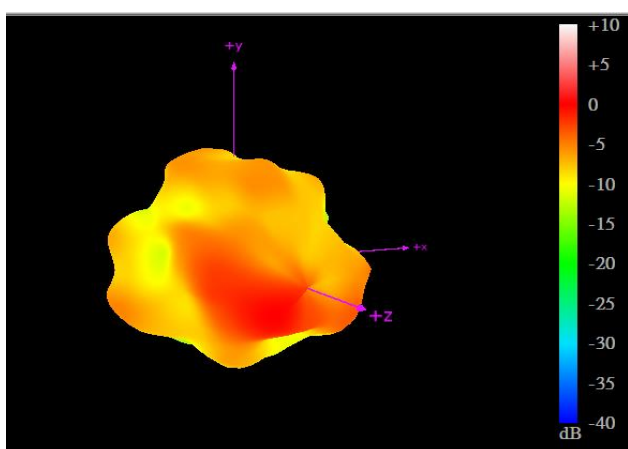

2690MHz

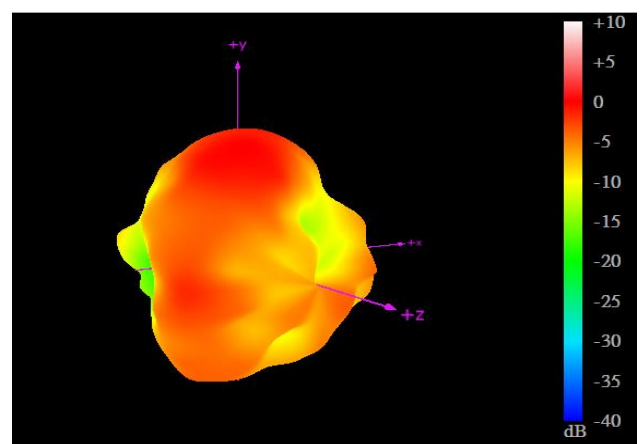

3500MHz

4. Mechanical Drawing (Units: mm)

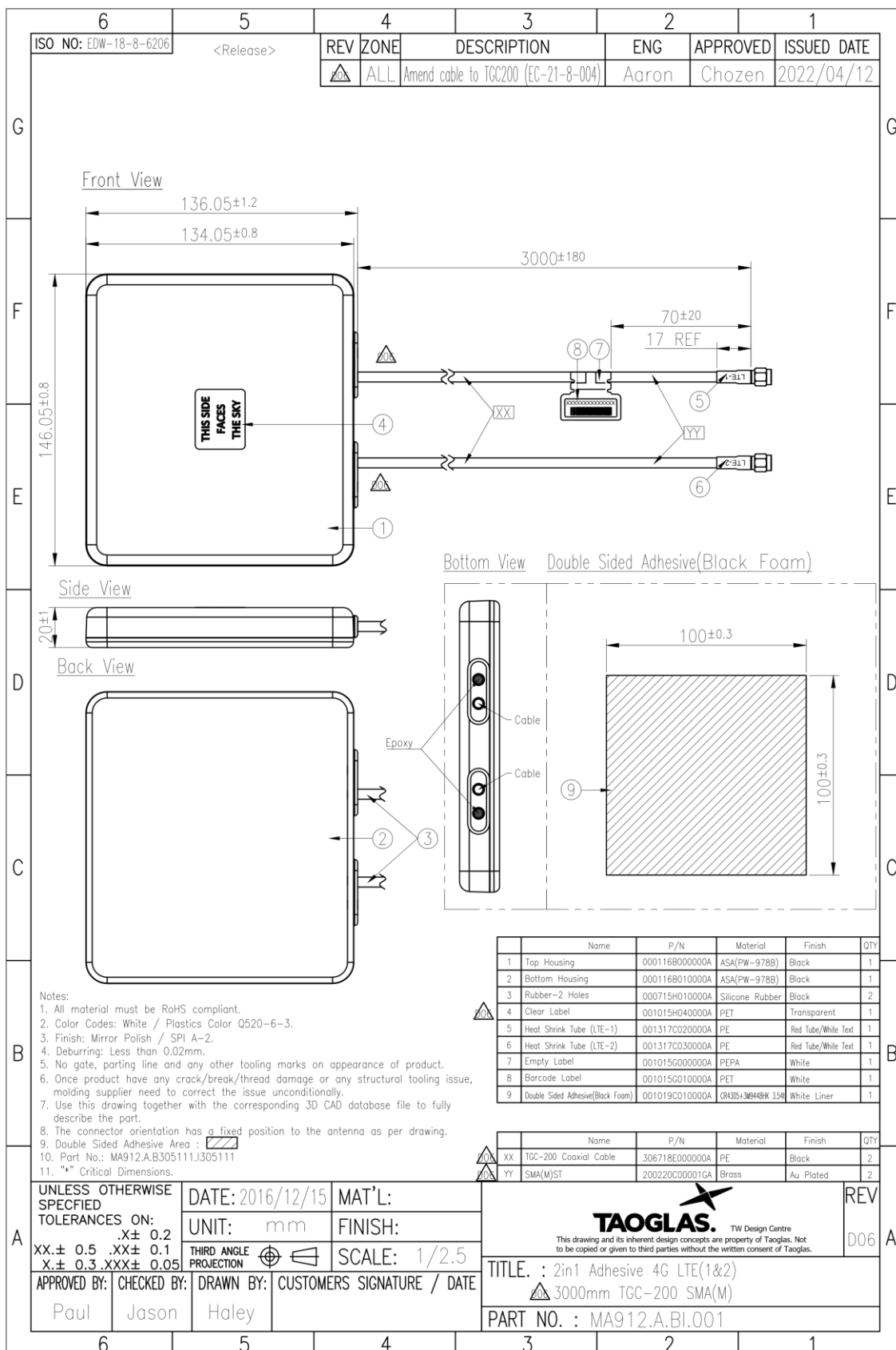

5. Packaging

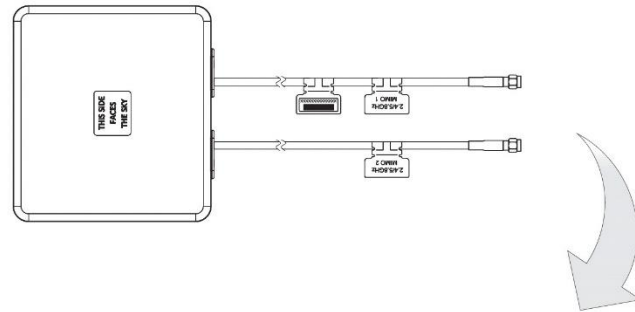

1 No. MA912.A.BI.001 per small box
 Box Dimensions - 260 x 235 x 105mm
 Weight - 0.75Kg

8 pcs MA912.A.BI.001 per carton
 Carton Dimensions - 540 x 490 x 240mm
 Weight - 6.6Kg

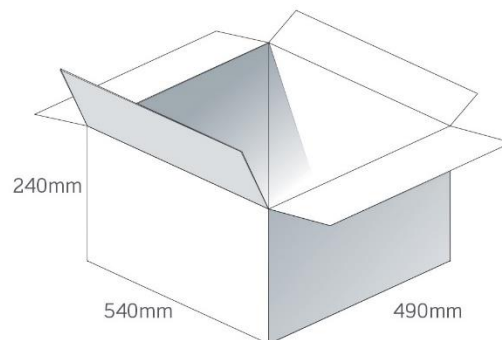

Pallet Dimensions 1200*1000*1400mm
 20 Cartons per Pallet
 4 Cartons per layer
 5 Layers

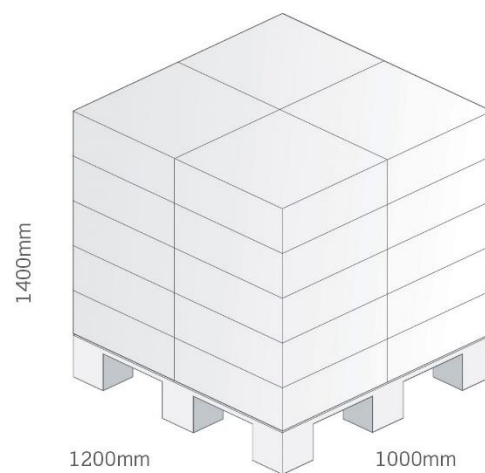

6. Application Note

6.1 In free space (LTE)

6.1.1 Return Loss (LTE MIMO 1)

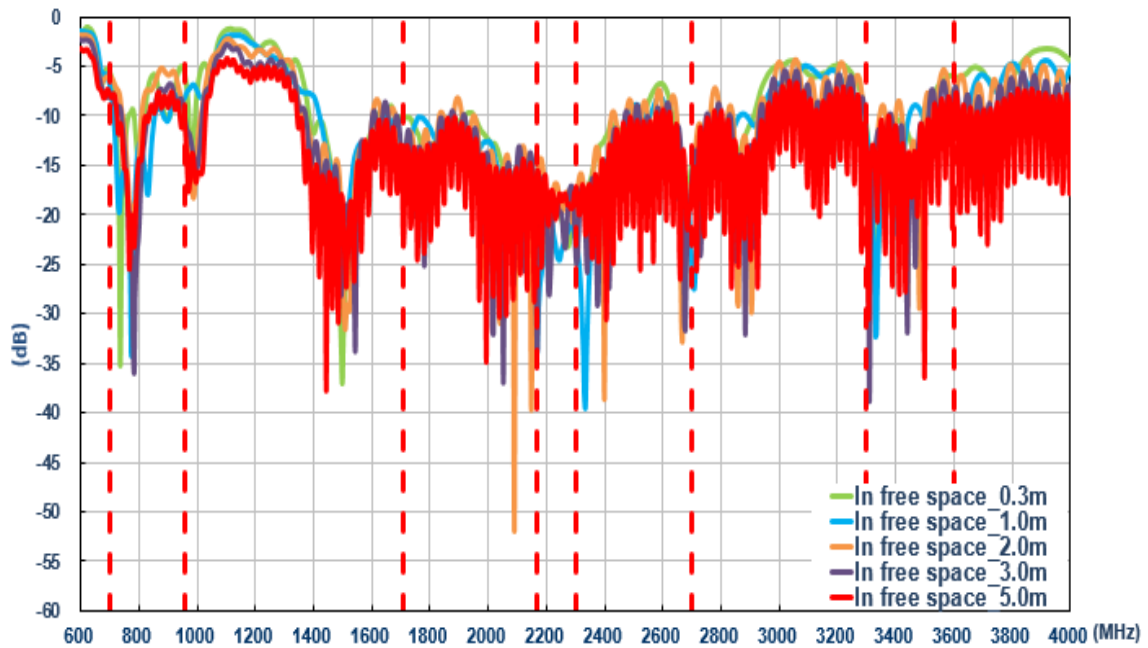

The MA912 antenna performance with different cable lengths is shown above.

6.1.2 Return Loss (LTE MIMO 2)

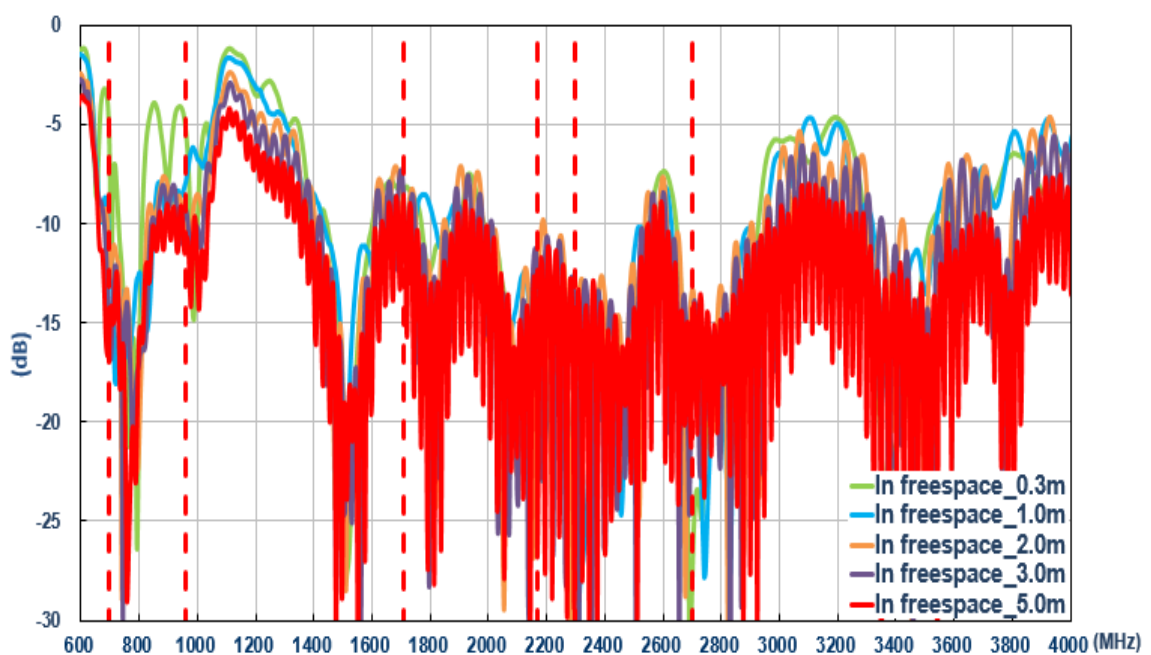

6.1.3 Isolation (LTE antenna)

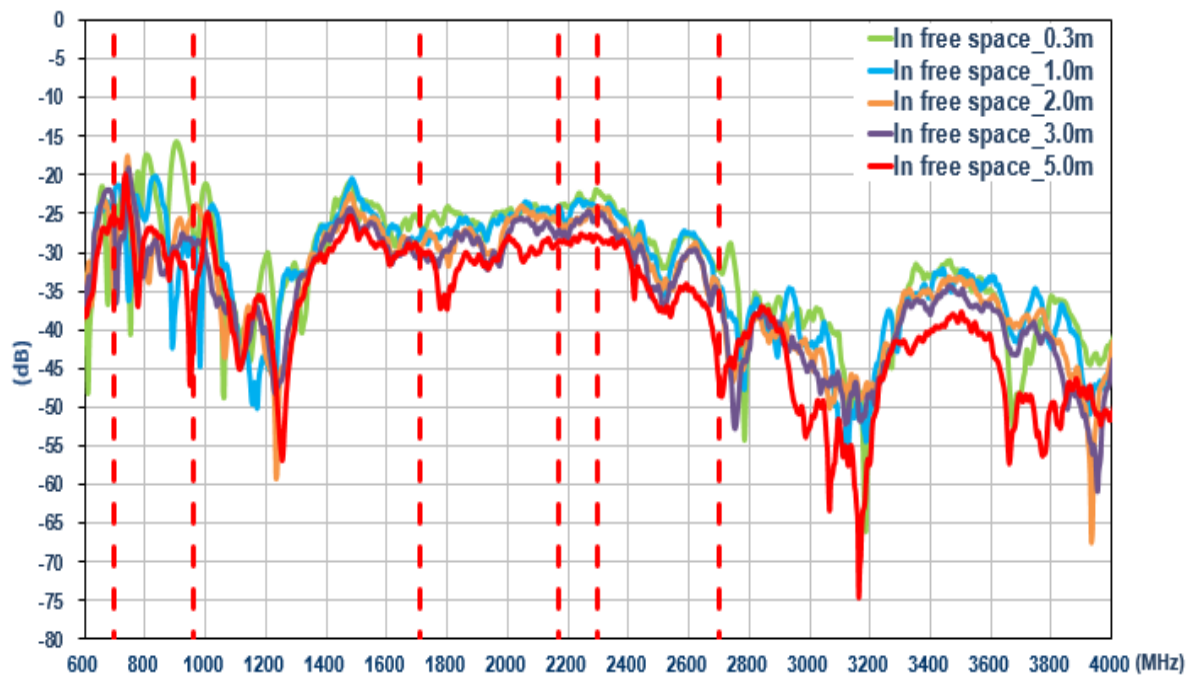

6.1.4 Efficiency (MIMO 1)

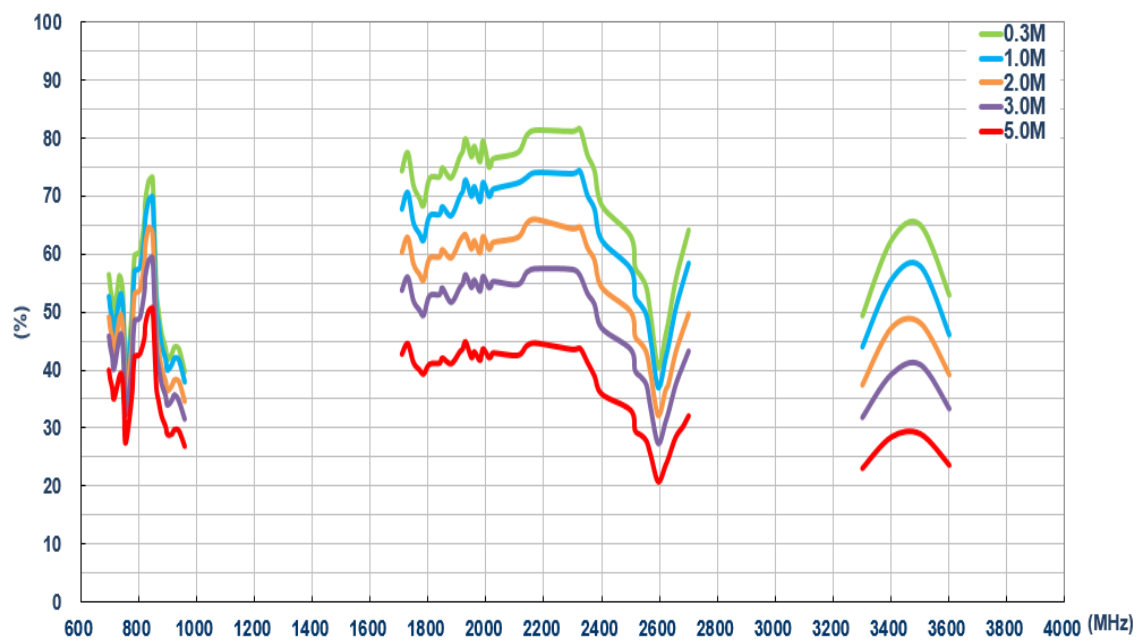

6.1.5 Efficiency (LTE MIMO 2)

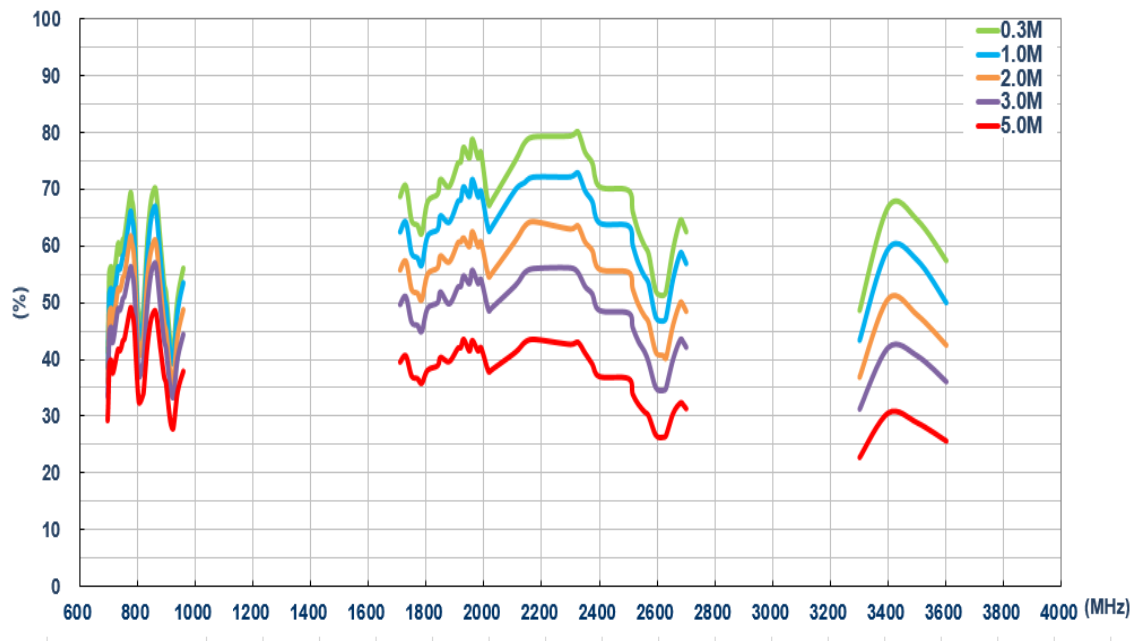

6.1.6 Average Gain (LTE MIMO 1)

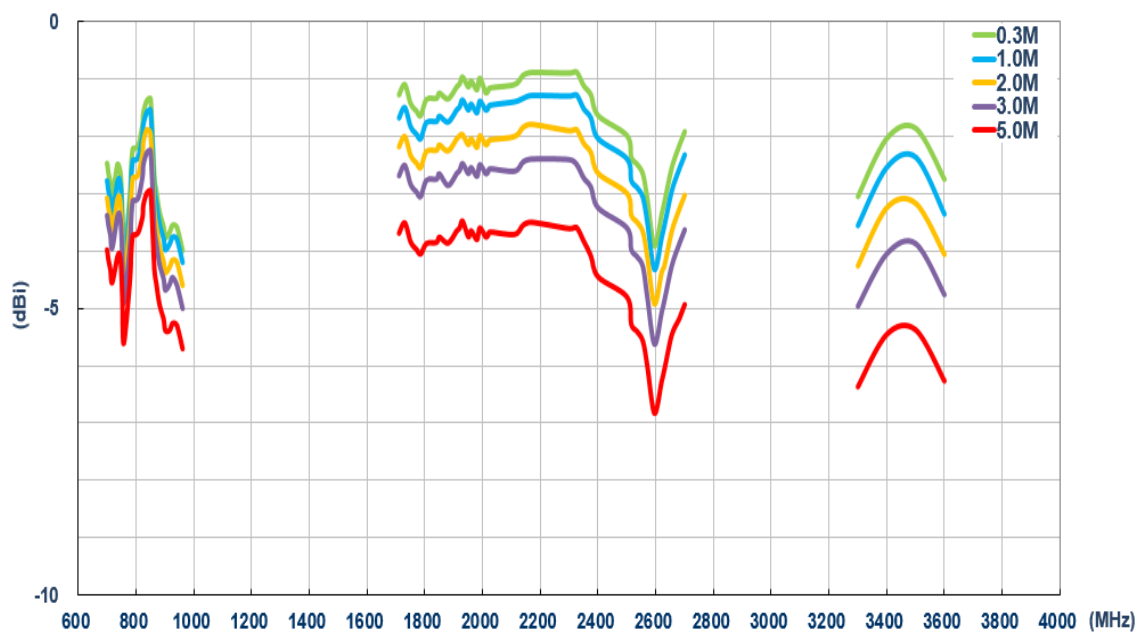

6.1.7 Average Gain (MIMO 2)

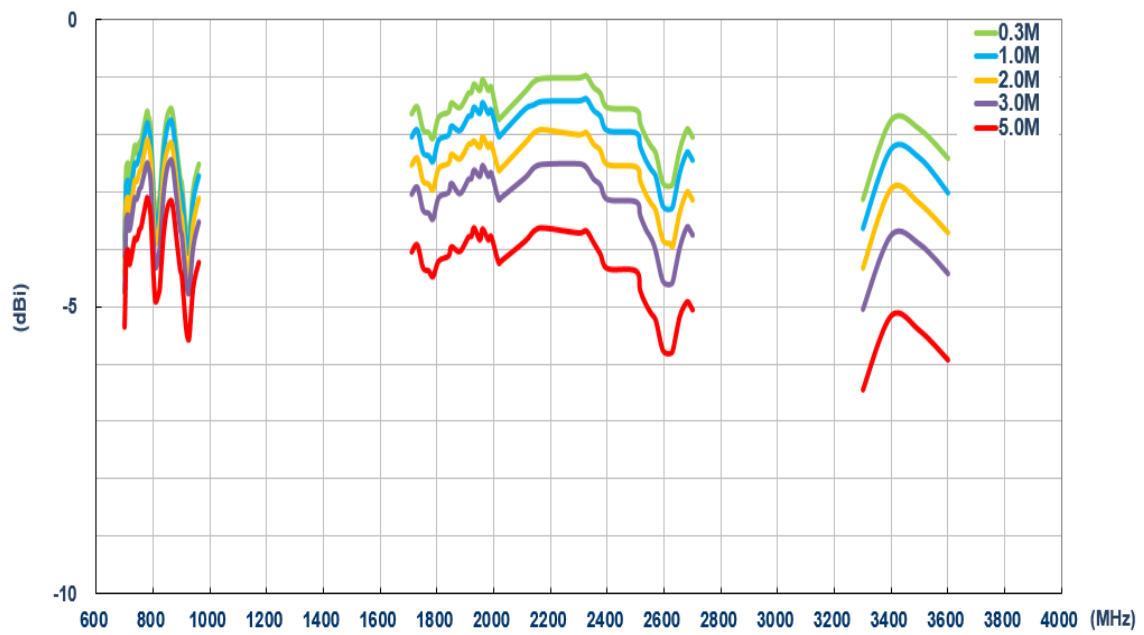

6.1.8 Peak Gain (MIMO 1)

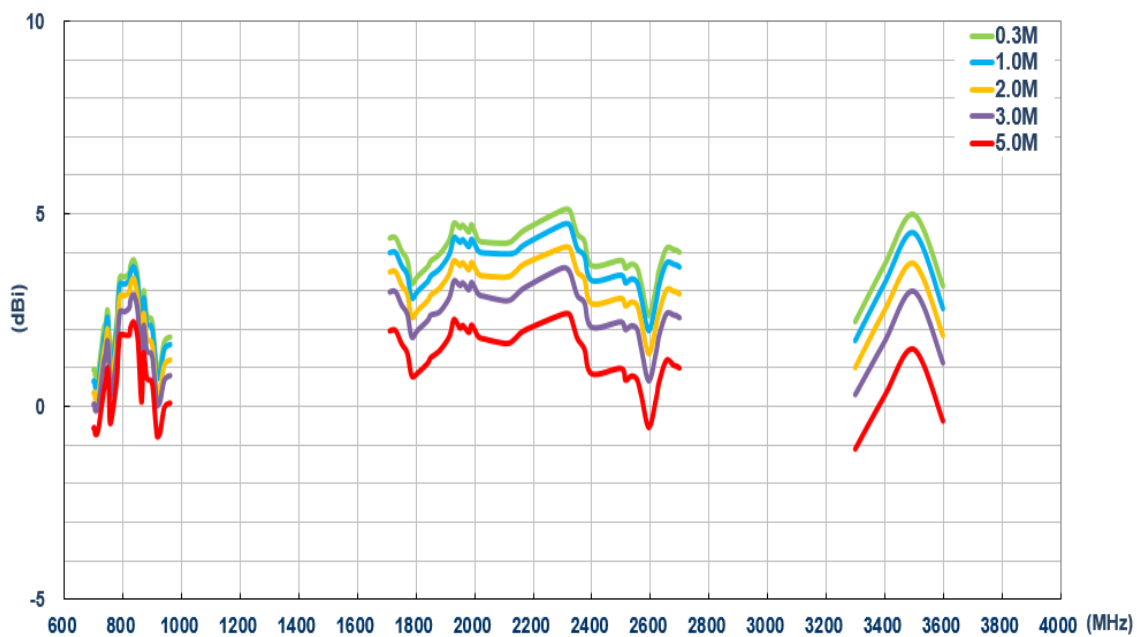

6.1.9 Peak Gain (MIMO 2)

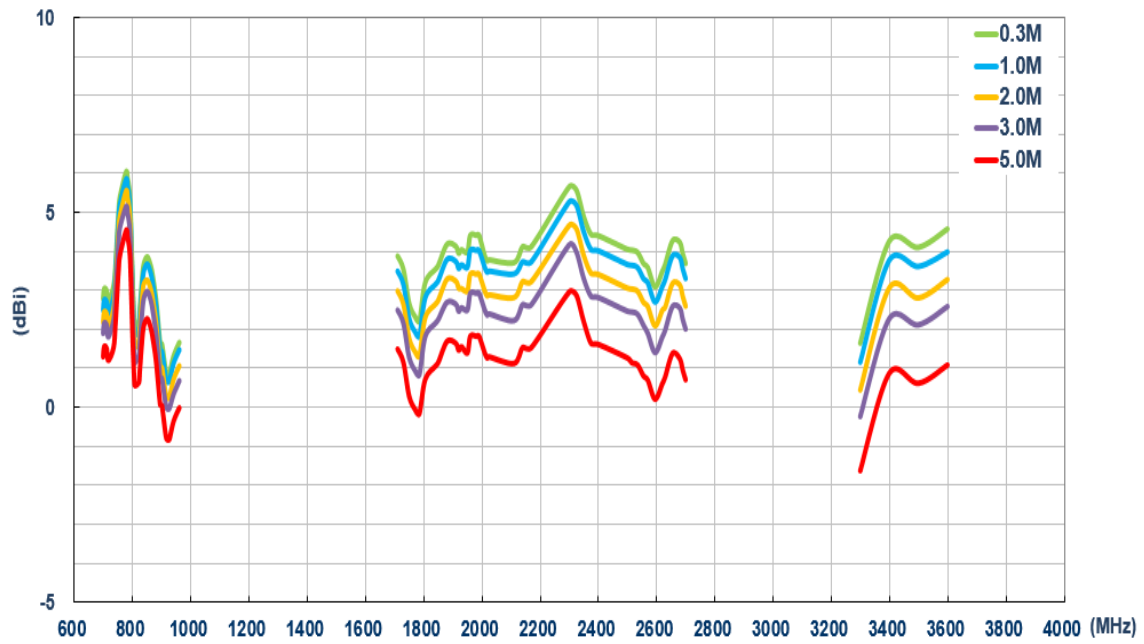

6.2 On the ABS (LTE)

6.2.1 Return Loss (LTE MIMO 1)

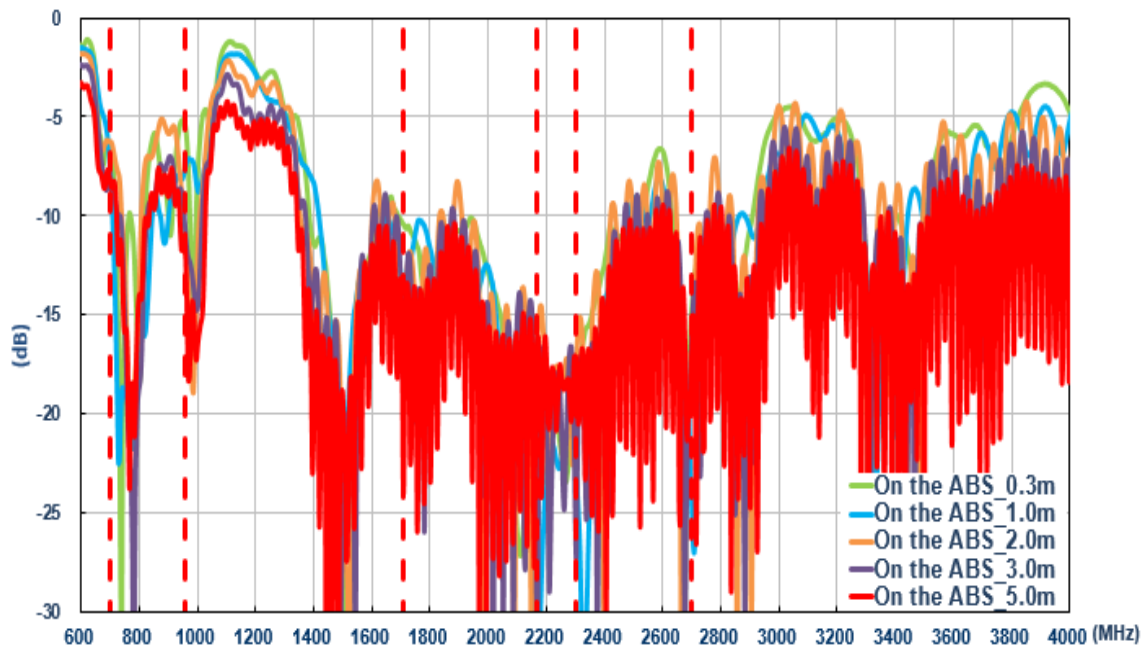

6.2.2 Return Loss (Wi-Fi MIMO 2)

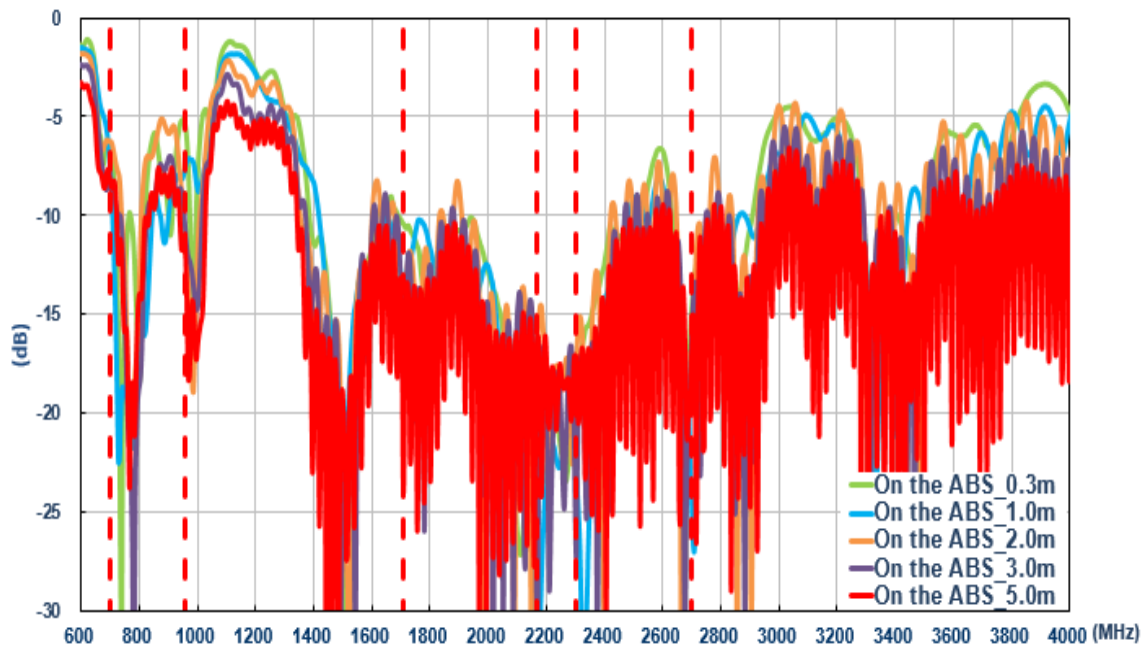

6.2.3 Isolation (LTE antenna)

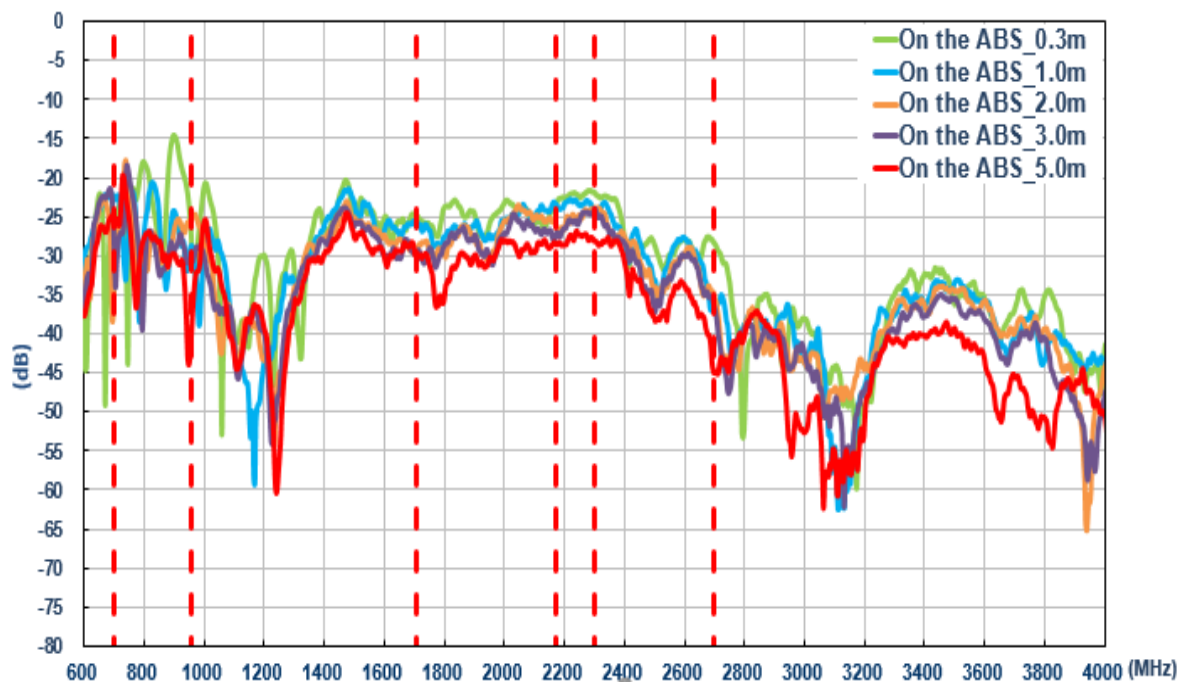

6.2.4 Efficiency (MIMO 1)

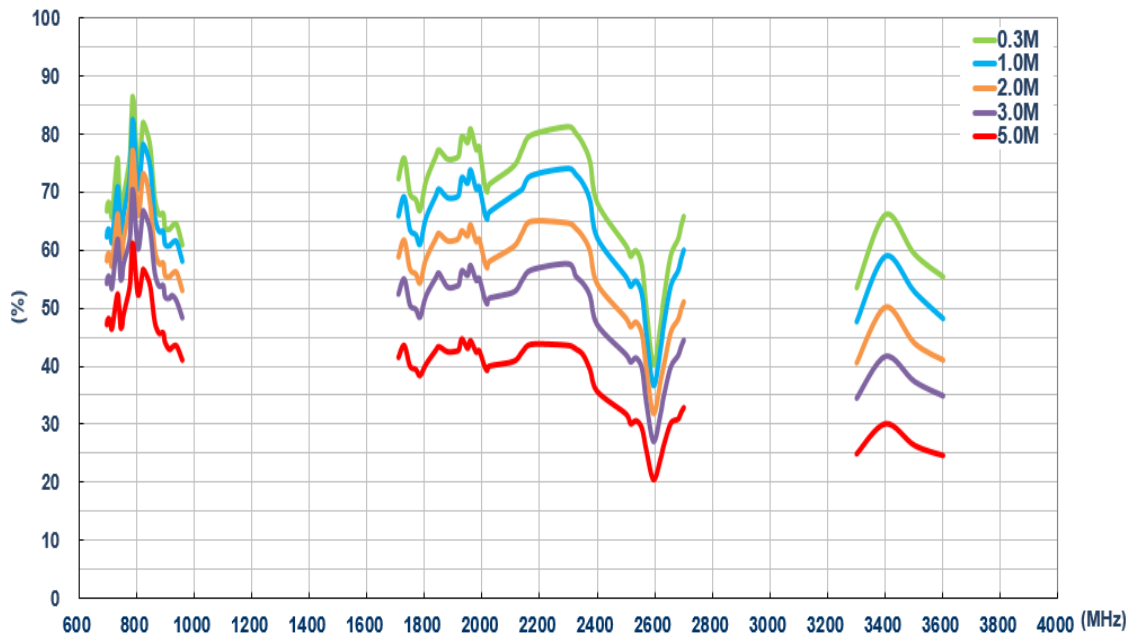

6.2.5 Efficiency (MIMO 2)

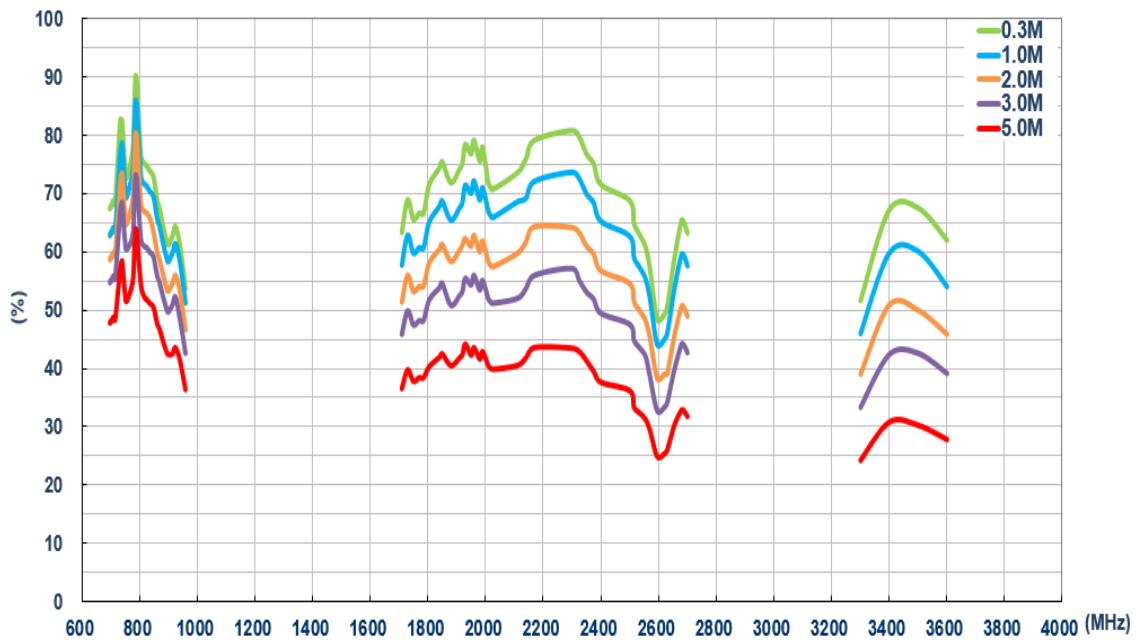

6.2.6 Average Gain (MIMO 1)

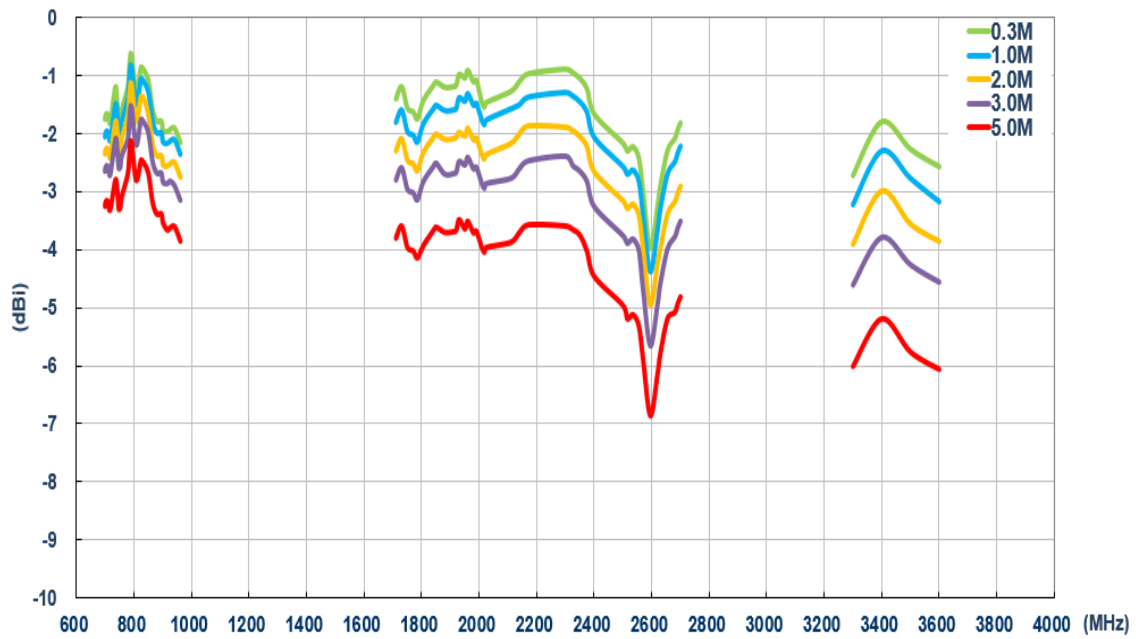

6.2.7 Average Gain (MIMO 2)

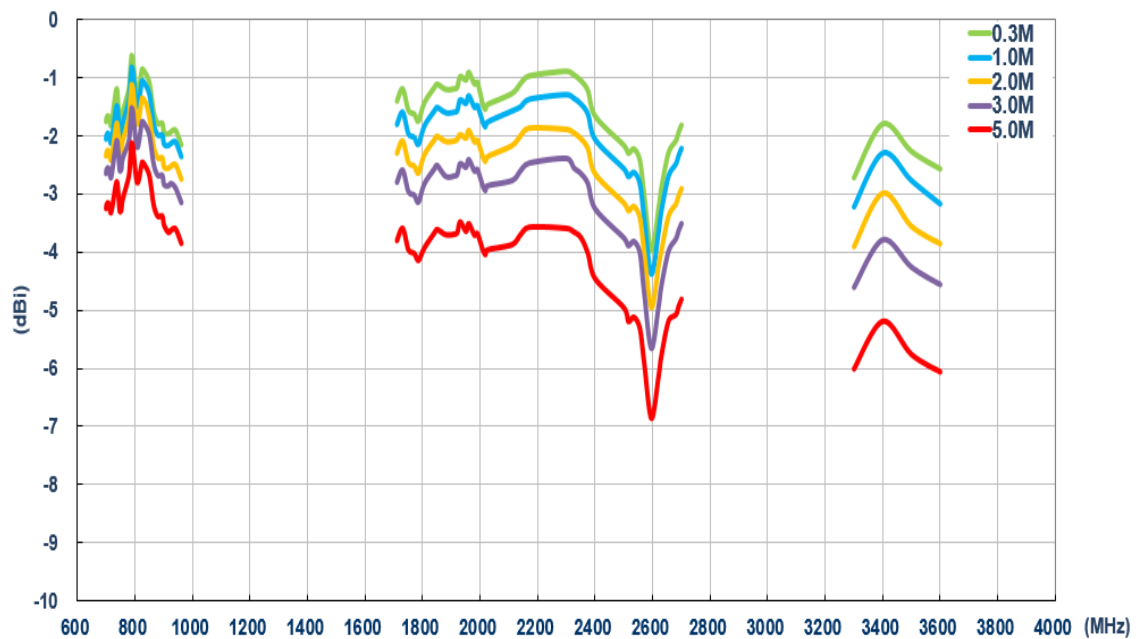

6.2.8 Peak Gain (MIMO 1)

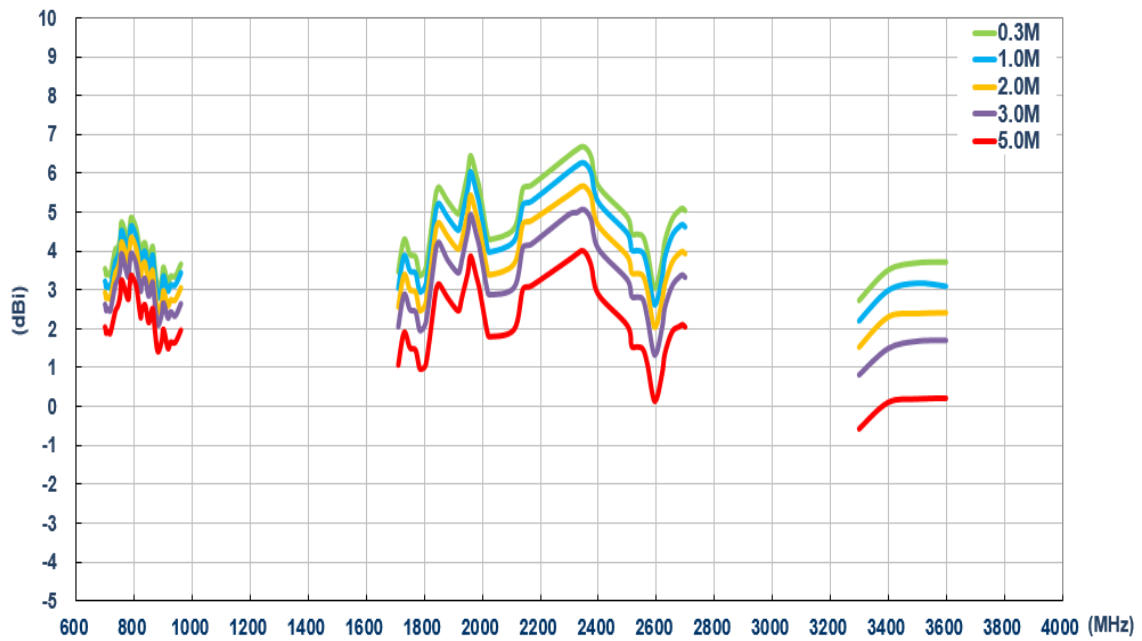

6.2.9 Peak Gain (MIMO 2)

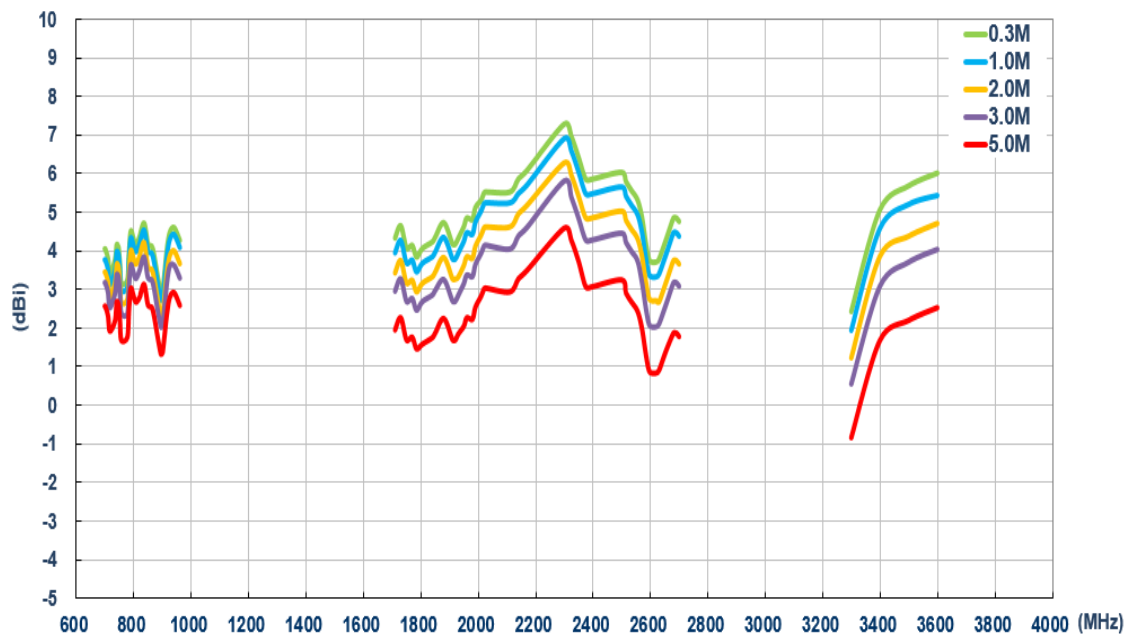

6.2 On the ABS (LTE)

6.2.1 Return Loss (LTE MIMO 1)

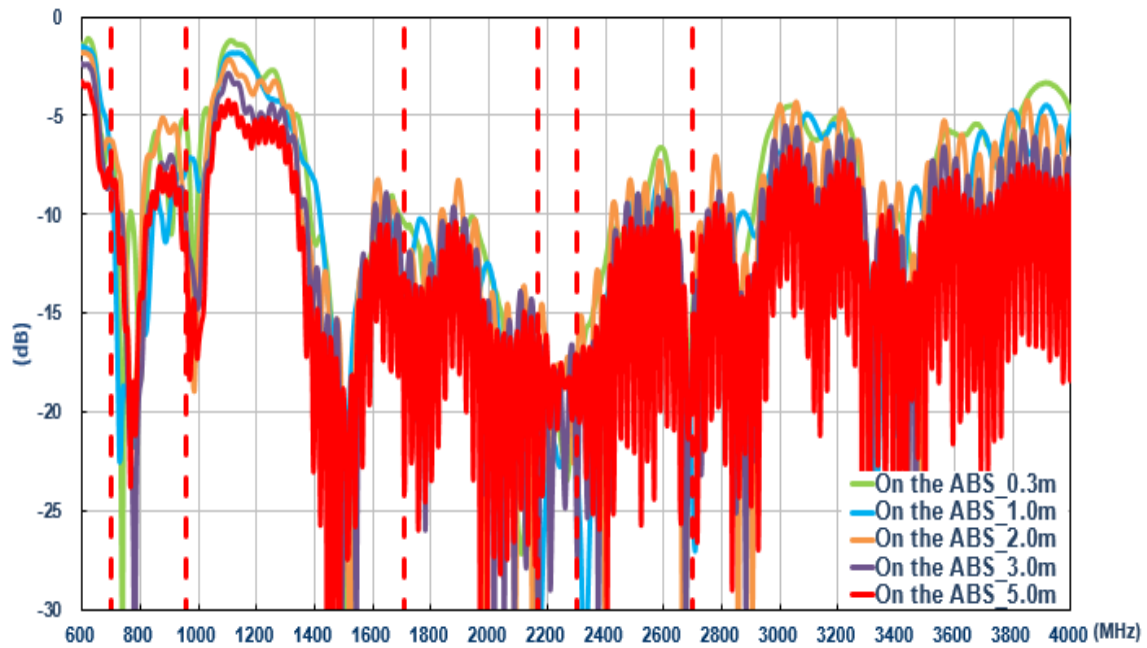

6.2.2 Return Loss (LTE MIMO 2)

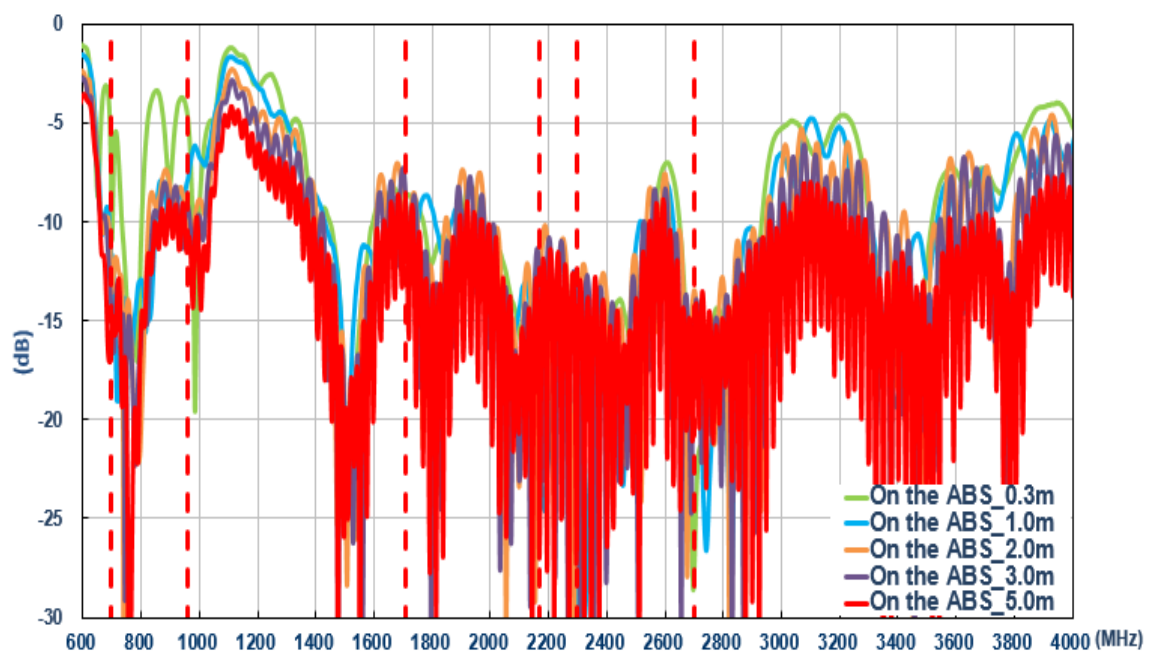

6.2.3 Isolation (LTE antenna)

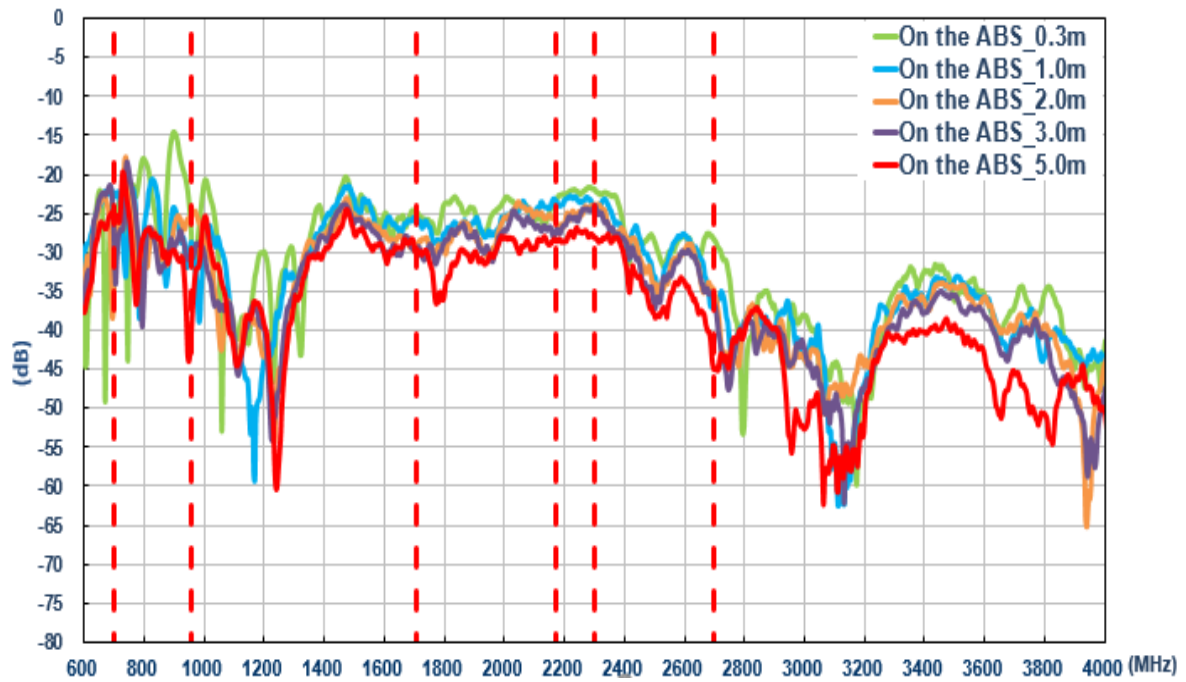

6.2.4 Efficiency (MIMO 1)

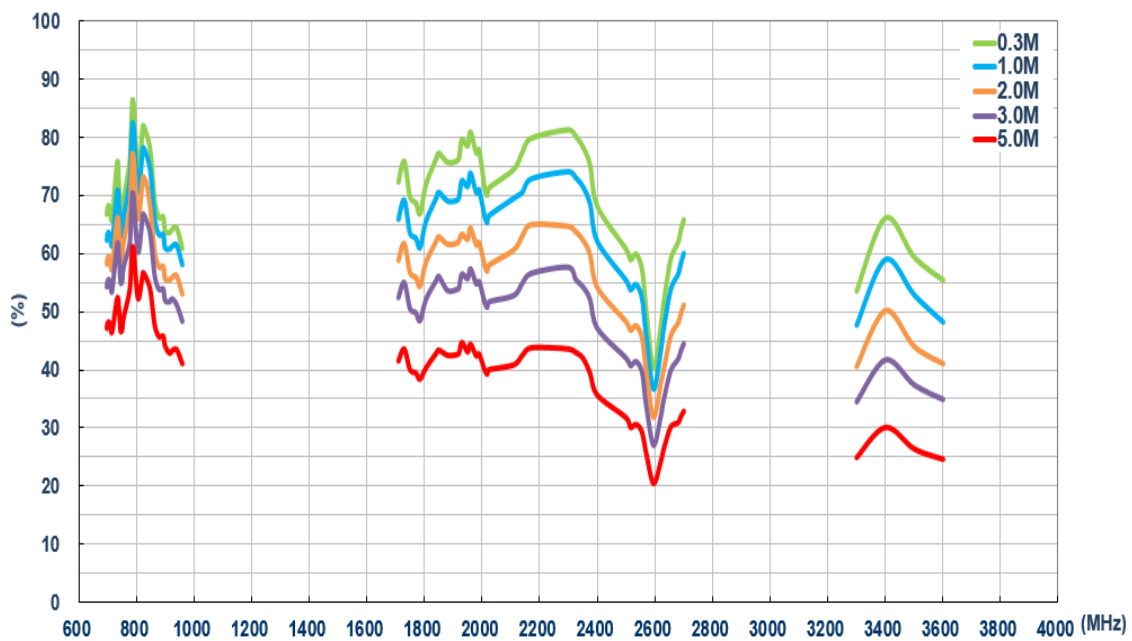

6.2.5 Efficiency (MIMO 2)

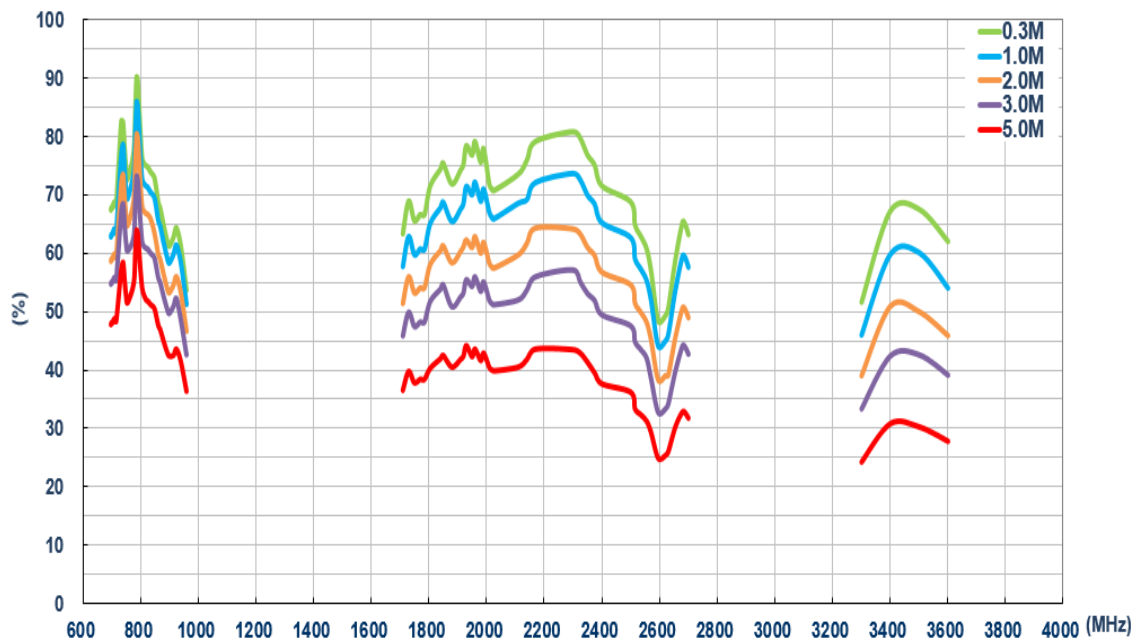

6.2.6 Average Gain (LTE MIMO 1)

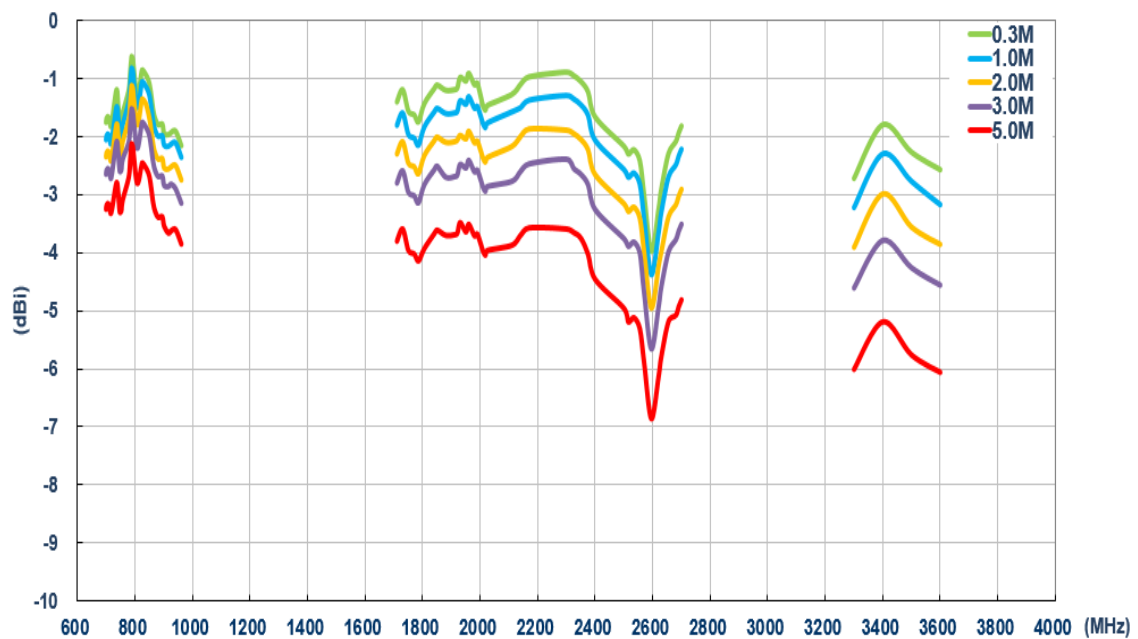

6.2.7 Average Gain (MIMO 2)

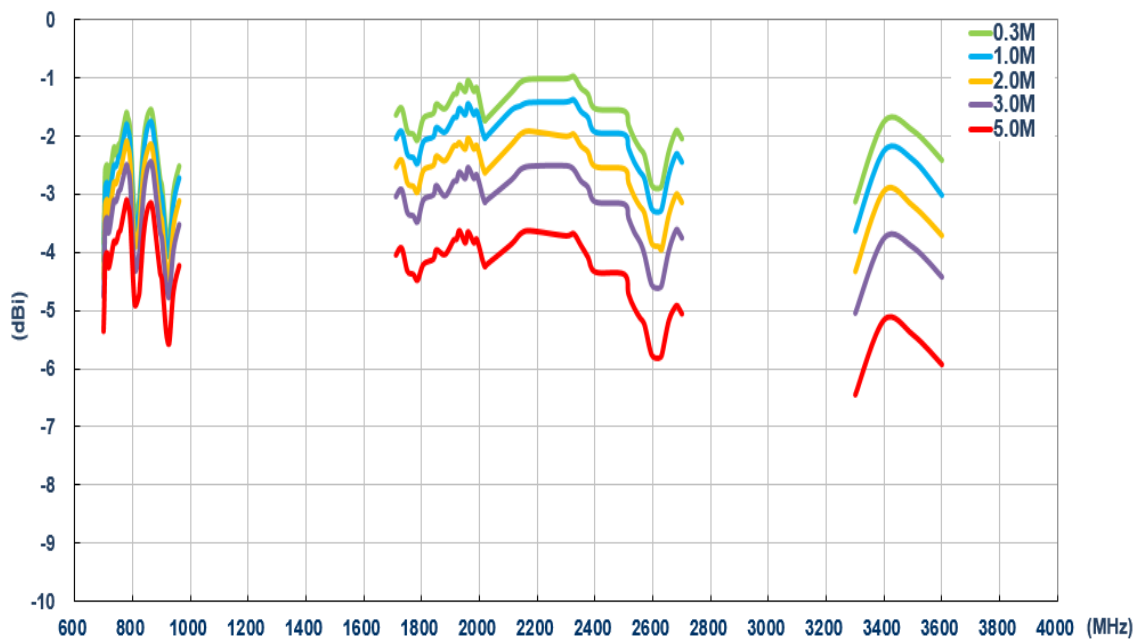

6.2.8 Peak Gain (MIMO 1)

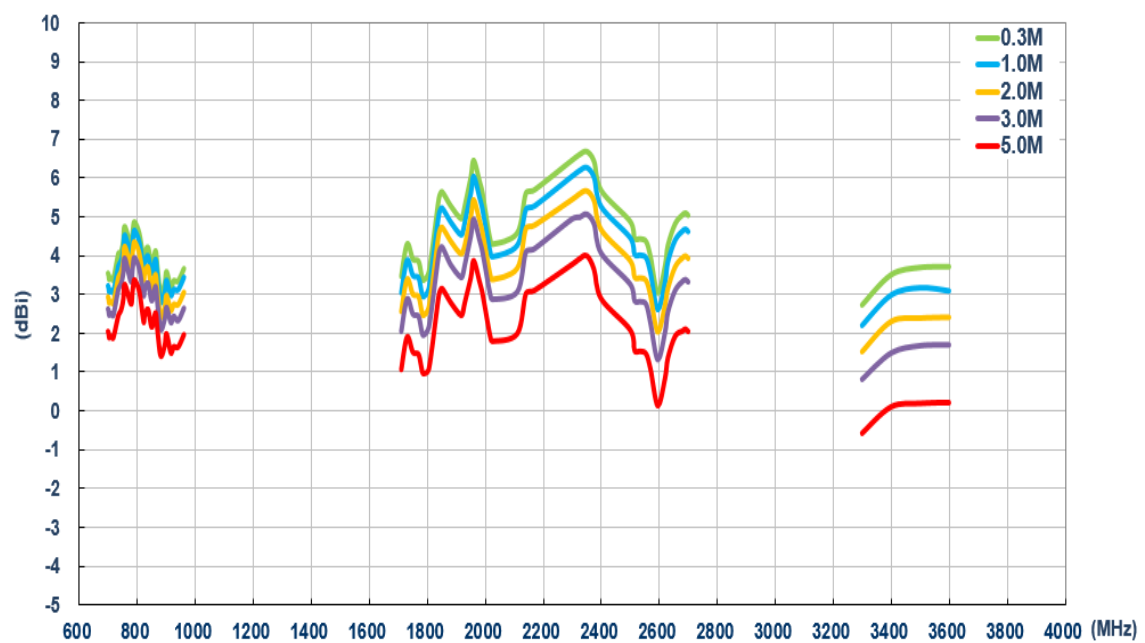

6.2.9 Peak Gain (MIMO 2)

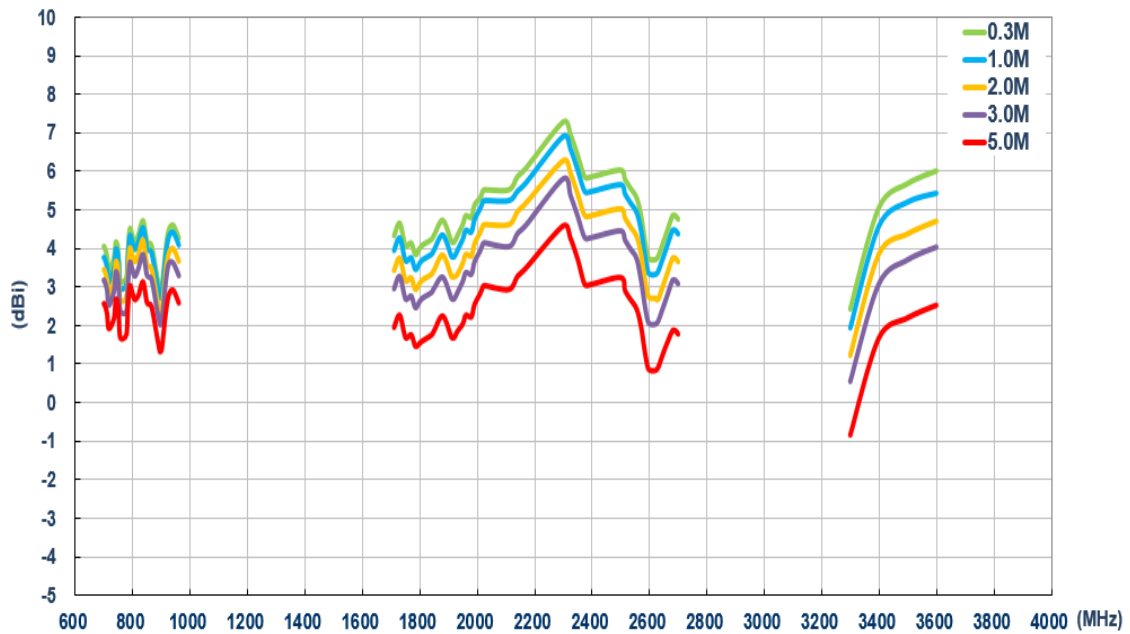

6.3 On the glass (LTE)

6.3.1 Return Loss (LTE MIMO 1)

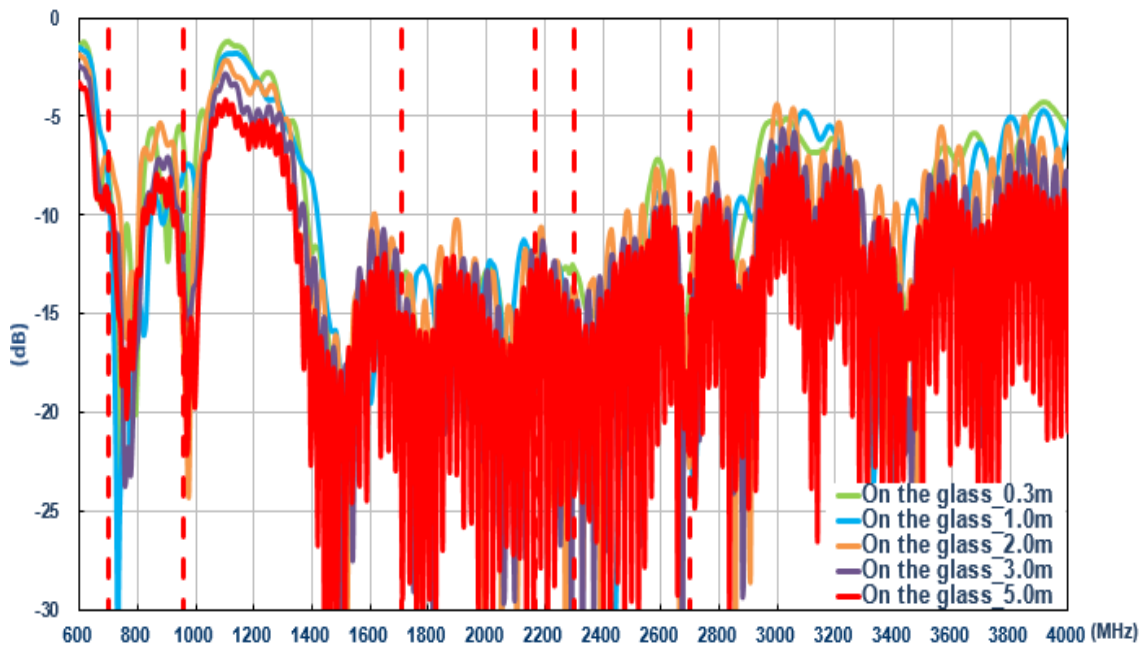

6.3.2 Return Loss (Wi-Fi MIMO 2)

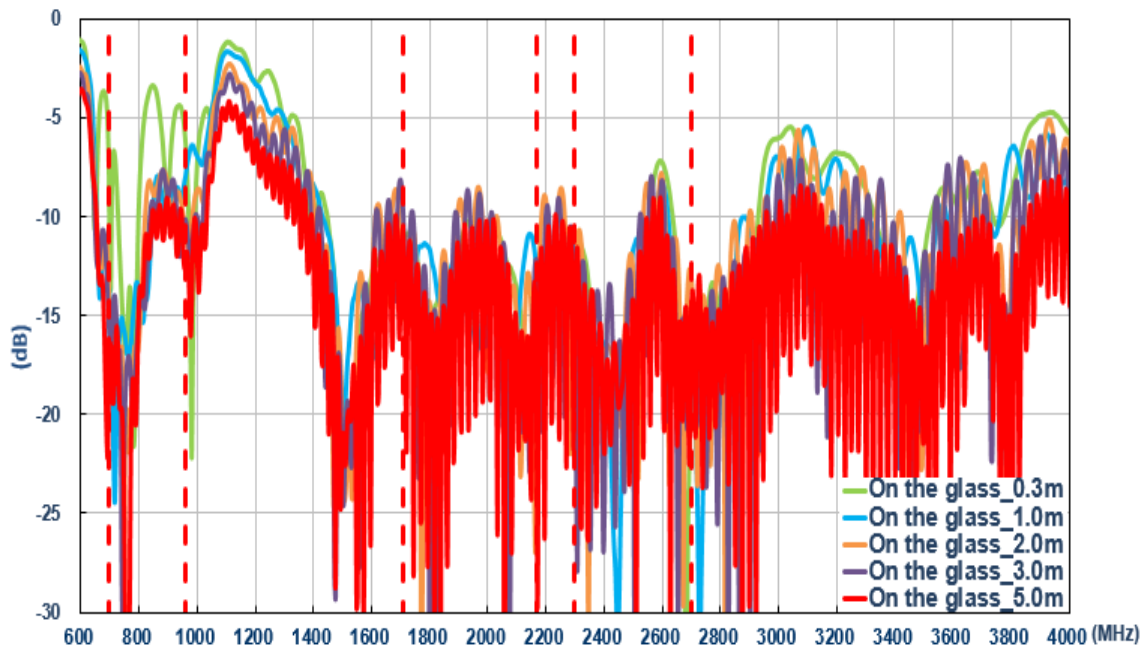

6.3.3 Isolation (LTE antenna)

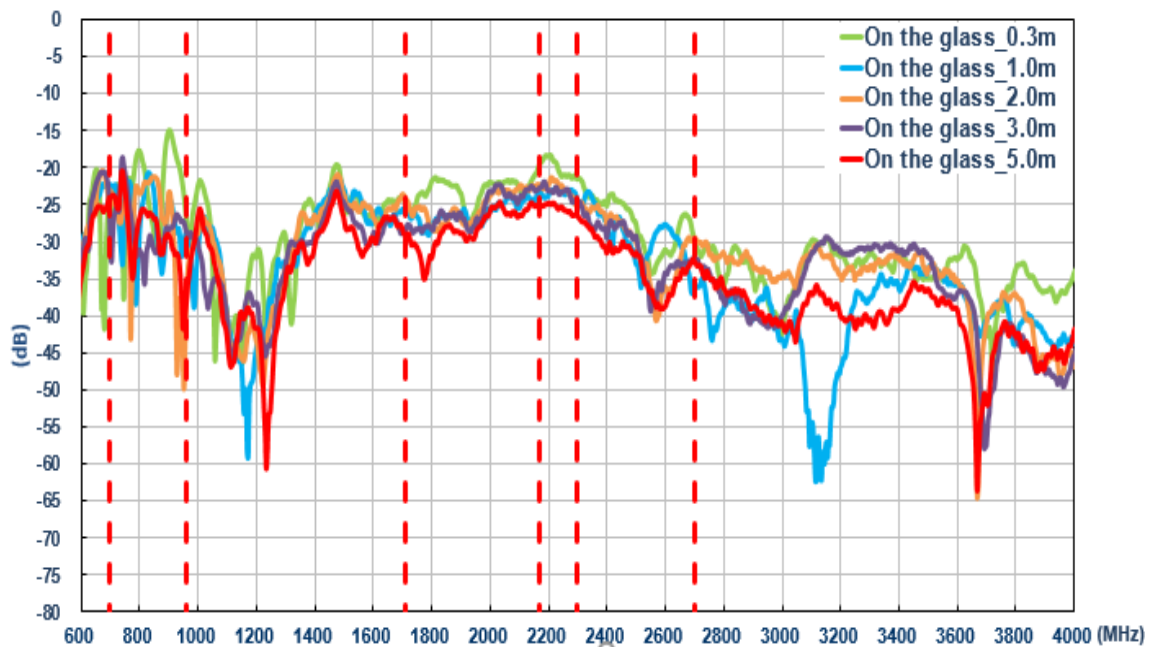

6.3.4 Efficiency (MIMO 1)

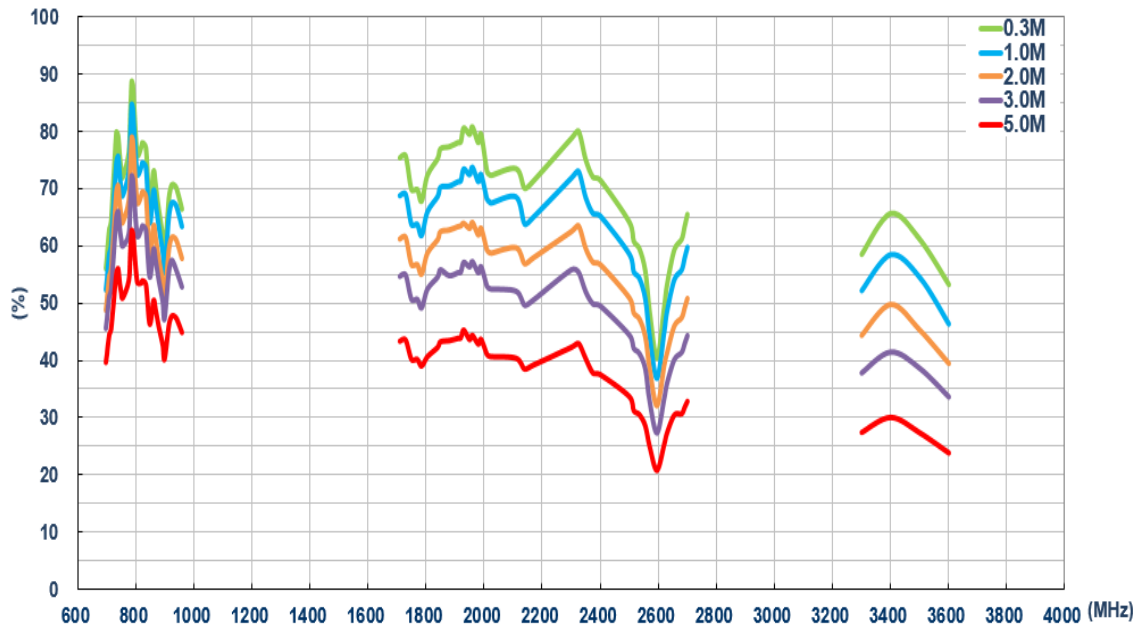

6.3.5 Efficiency (MIMO 2)

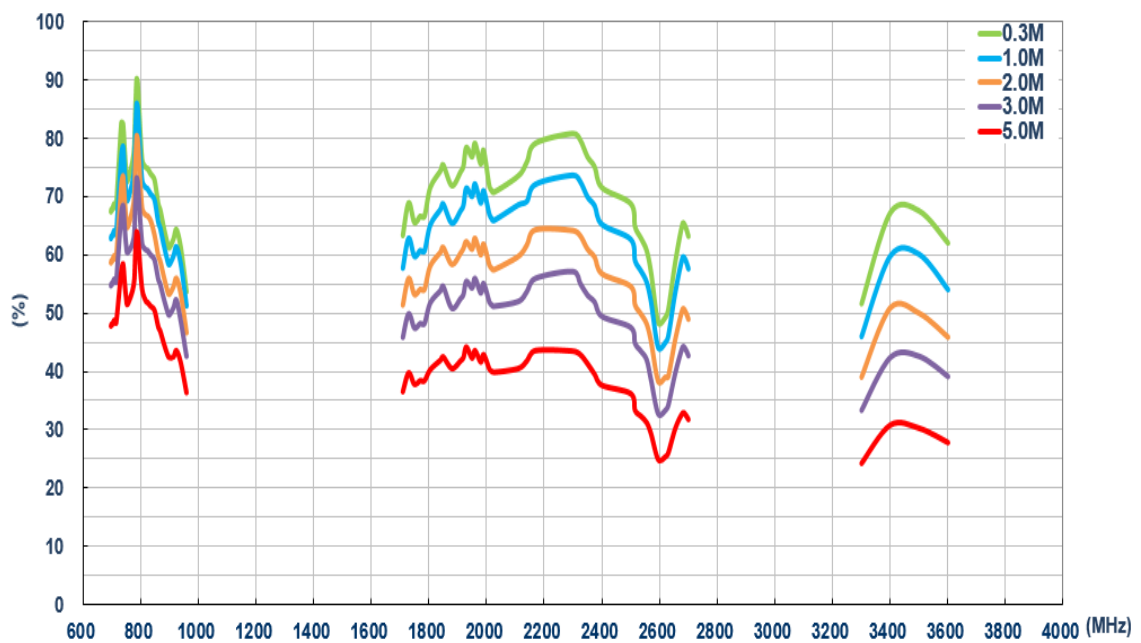

6.3.6 Average Gain (MIMO 1)

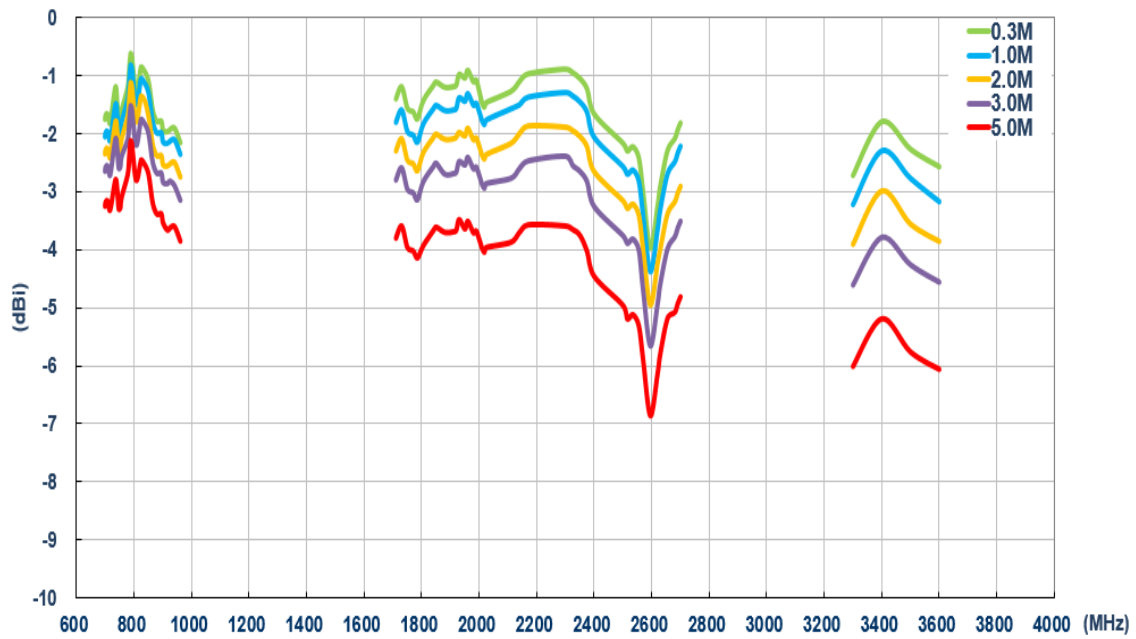

6.3.7 Average Gain (MIMO 2)

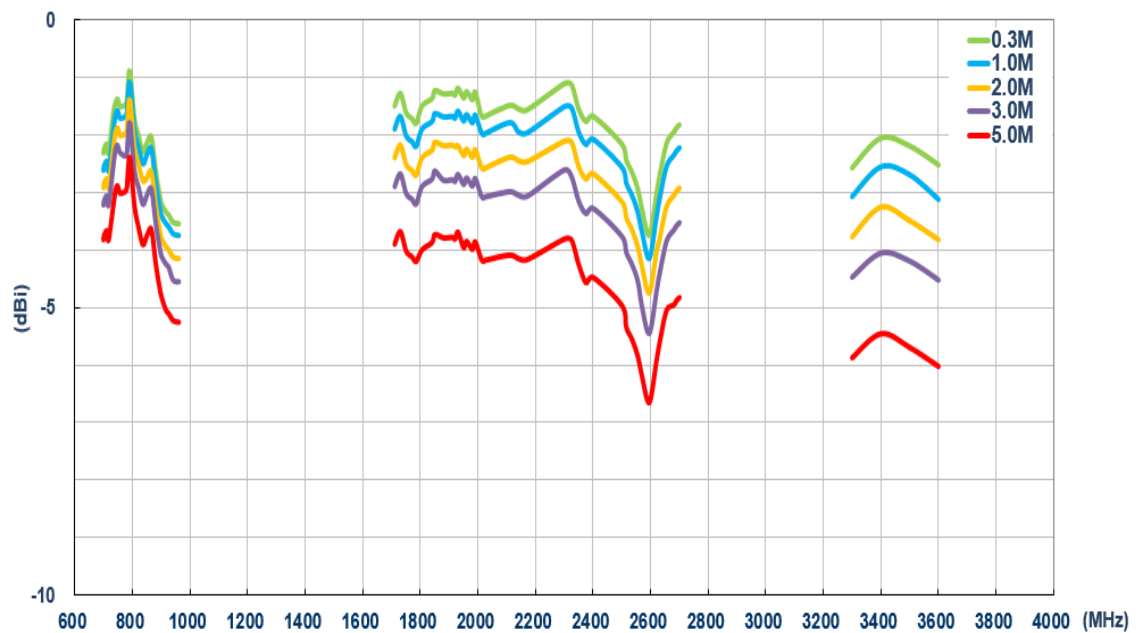

6.3.8 Peak Gain (MIMO 1)

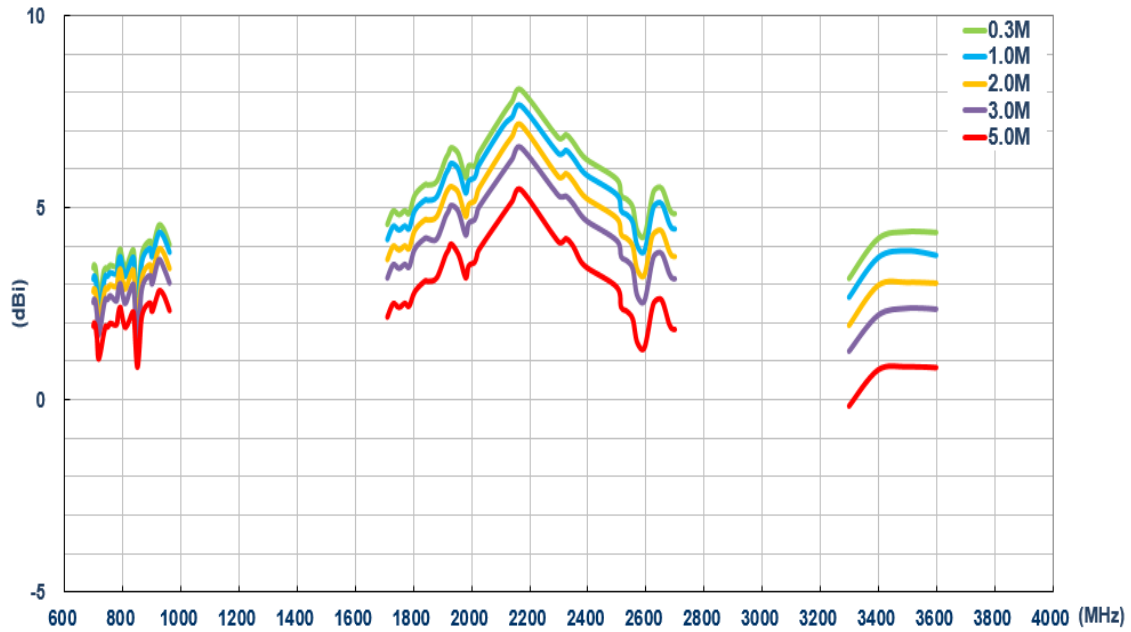

6.3.9 Peak Gain (MIMO 2)

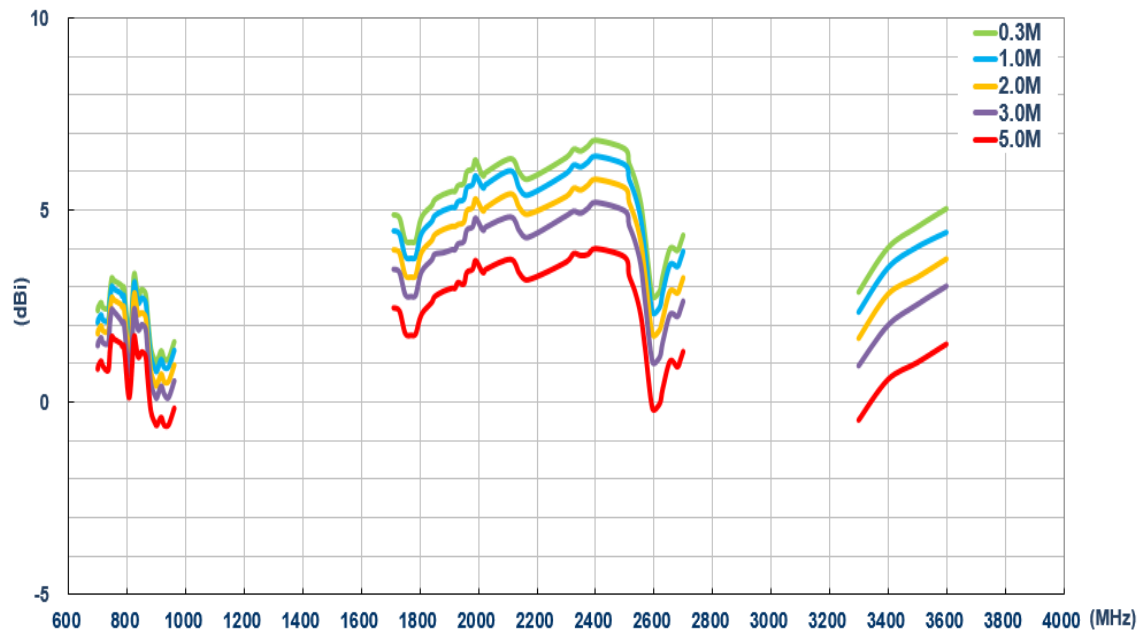

6.4 On the metal (LTE)

6.4.1 Return Loss (LTE MIMO 1)

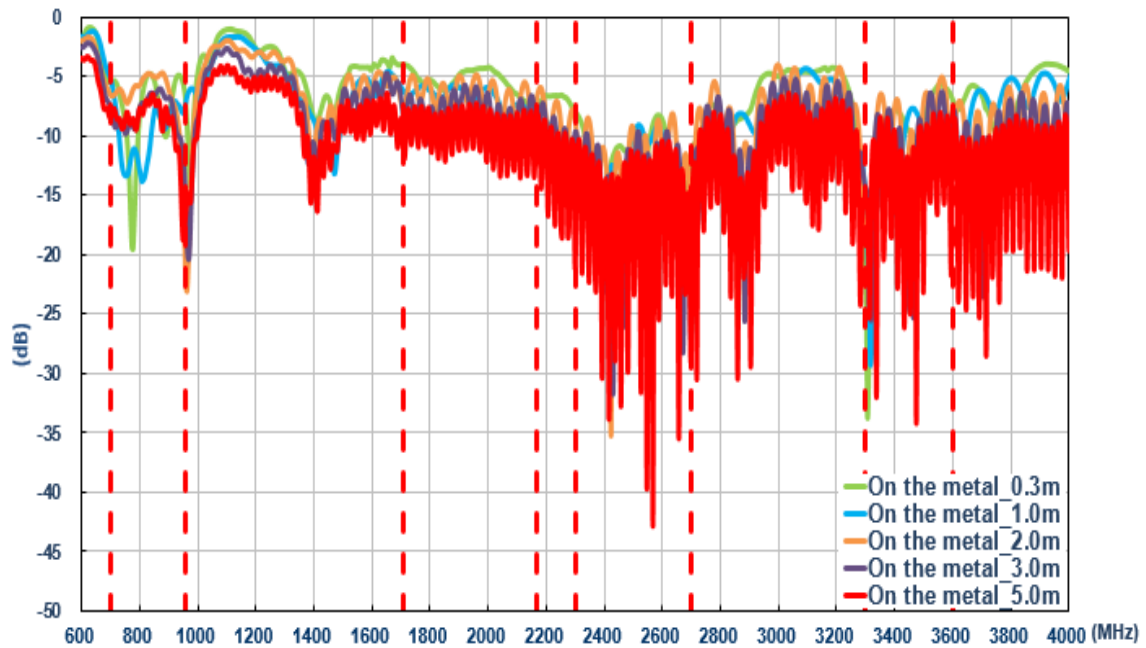

6.4.2 Return Loss (LTE MIMO 2)

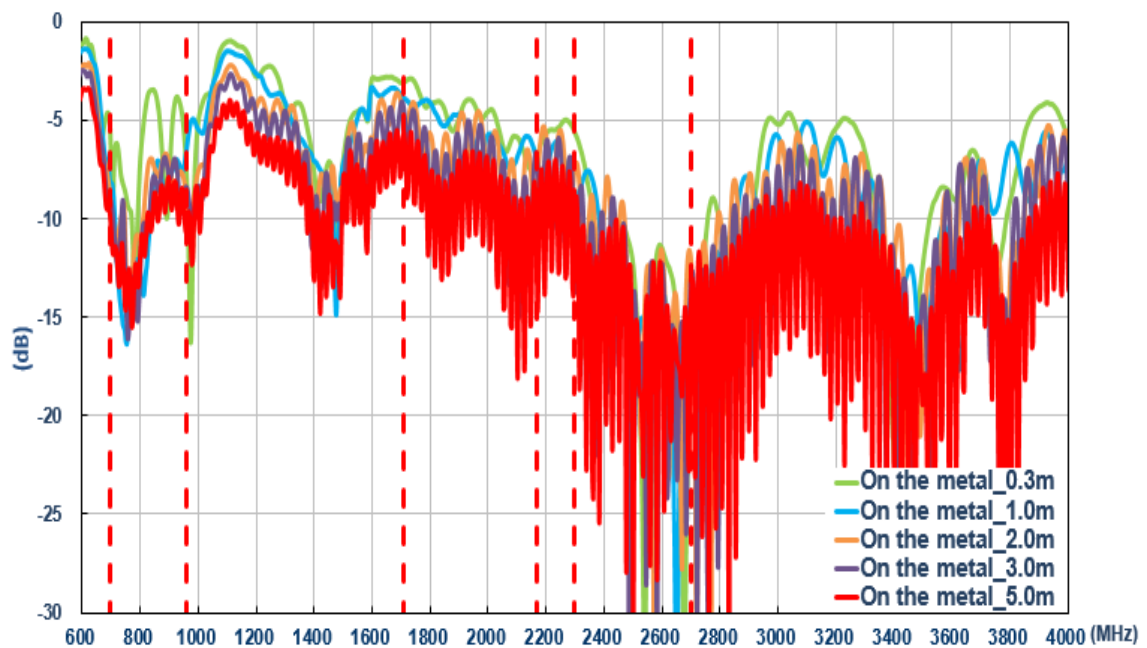

6.4.3 Isolation (LTE antenna)

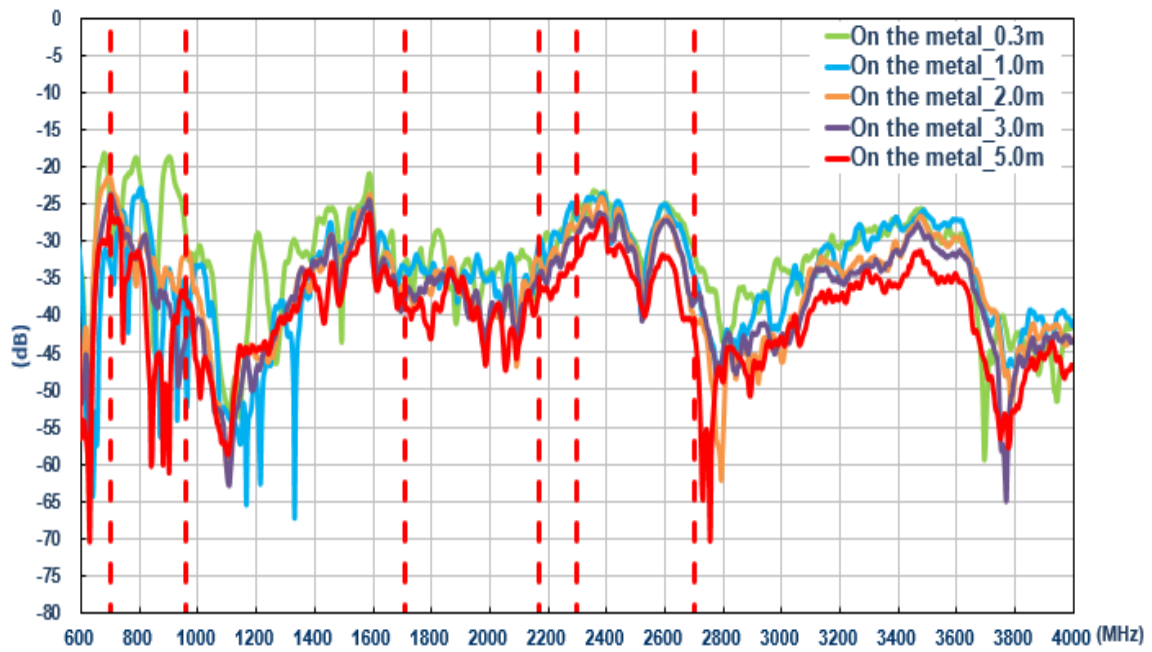

6.4.4 Efficiency (MIMO 1)

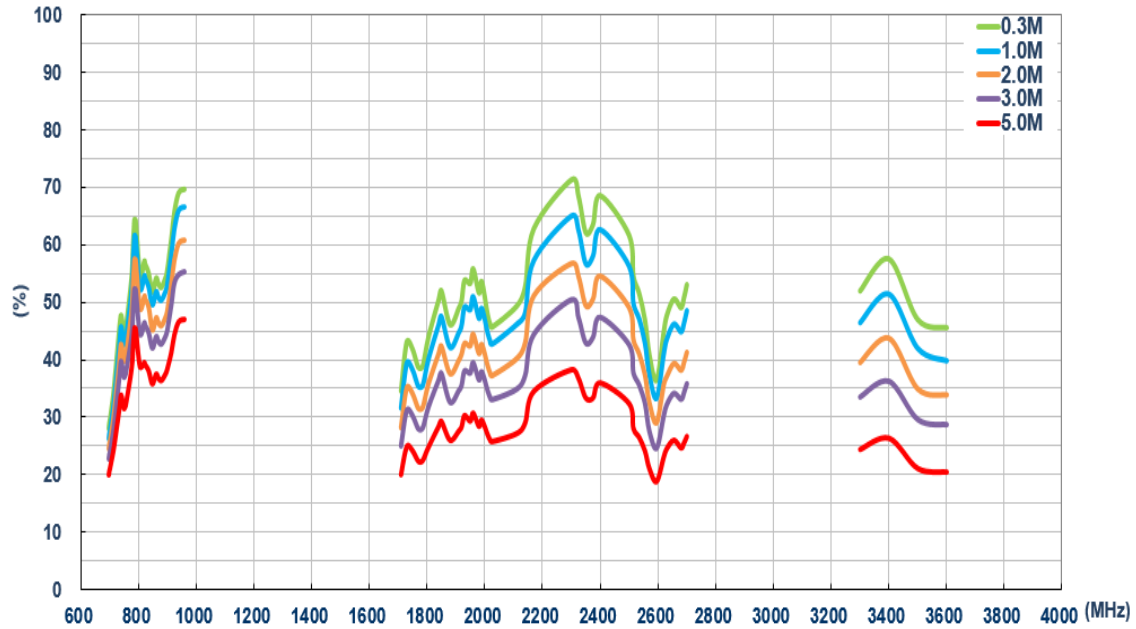

6.4.5 Efficiency (MIMO 2)

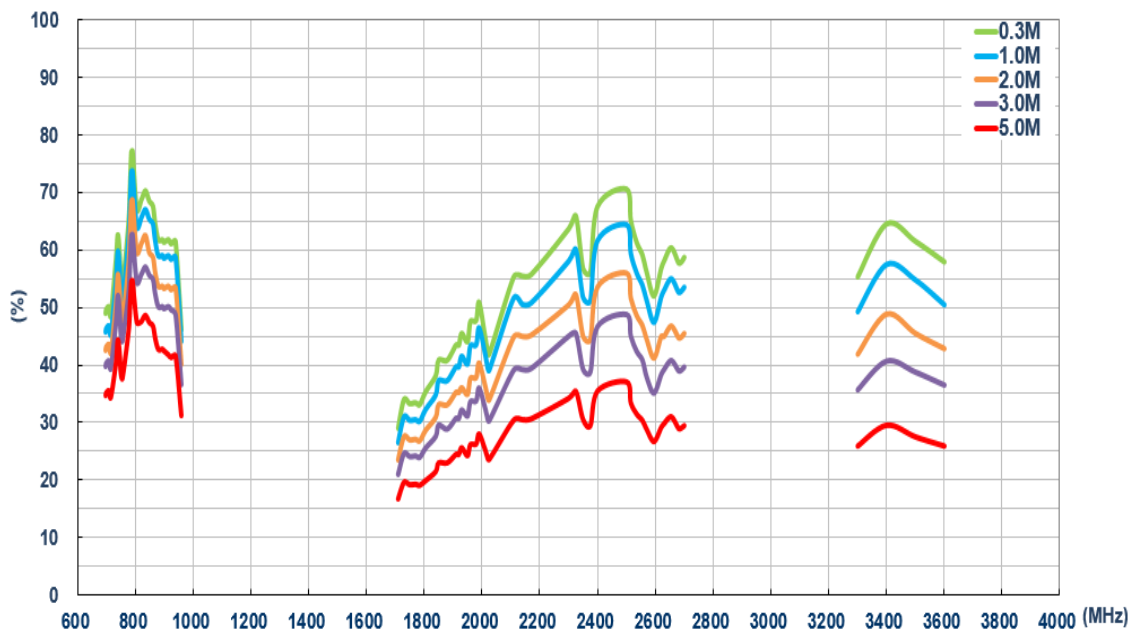

6.4.6 Average Gain (LTE MIMO 1)

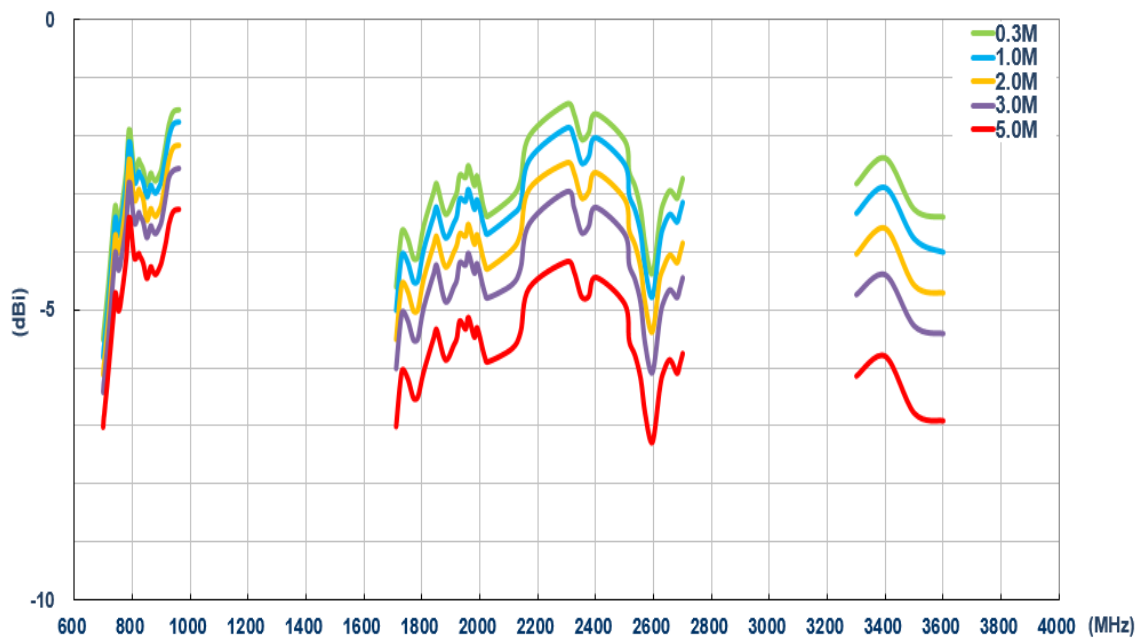

6.4.7 Average Gain (MIMO 2)

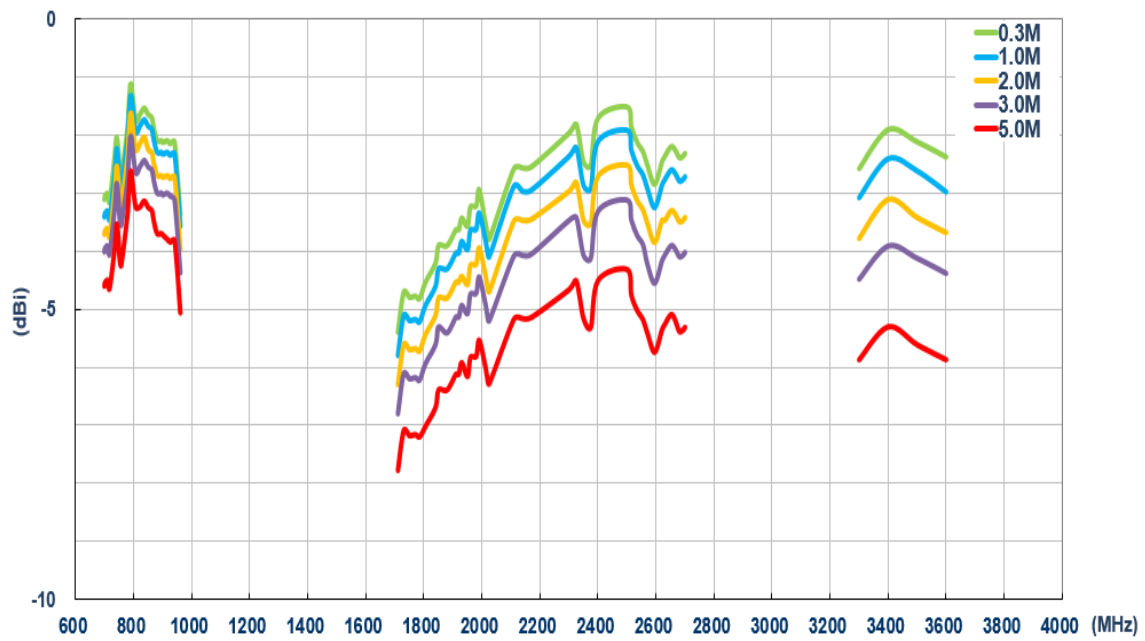

6.4.8 Peak Gain (MIMO 1)

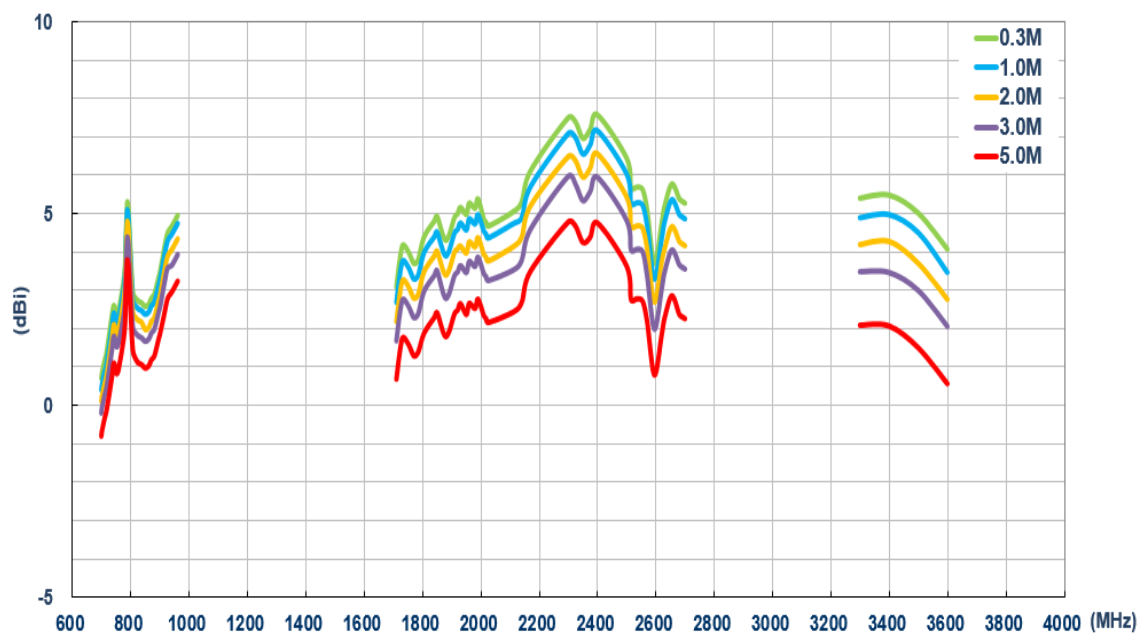

6.4.9 Peak Gain (MIMO 2)

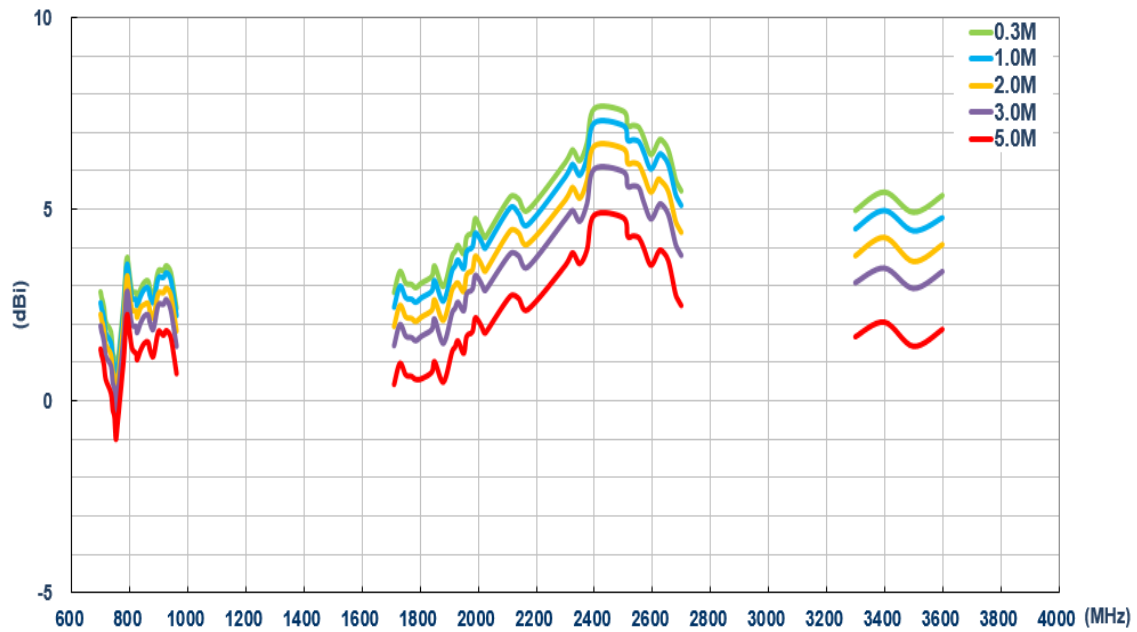

6.5 On the wall (LTE)

6.5.1 Return Loss (LTE MIMO 1)

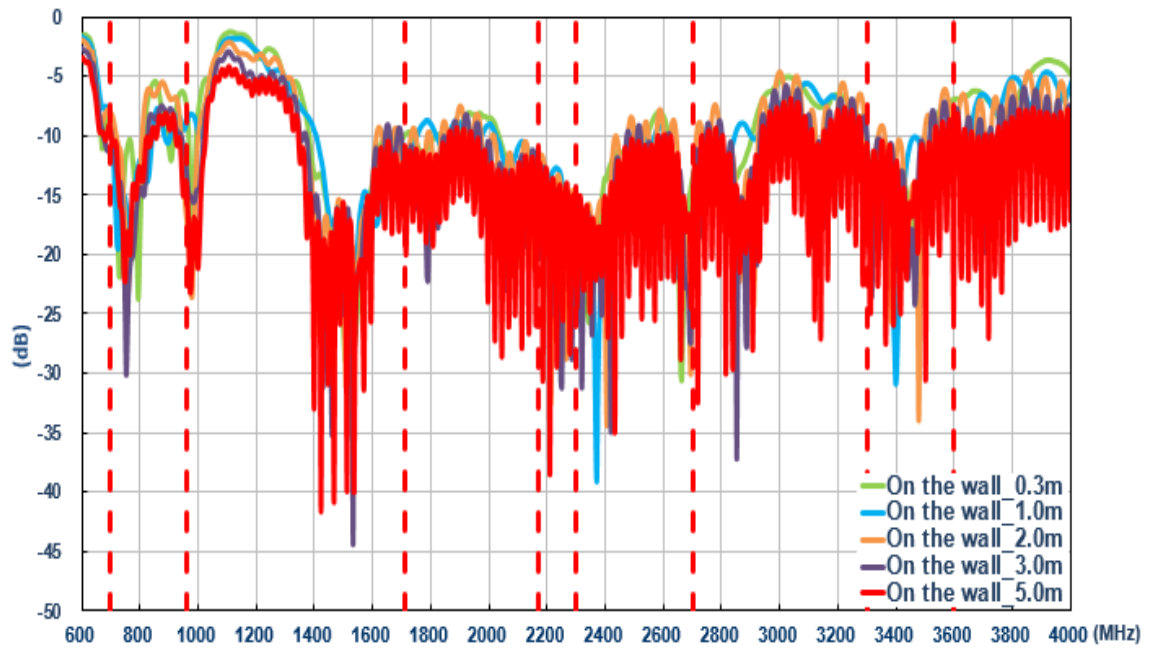

6.5.2 Return Loss (Wi-Fi MIMO 2)

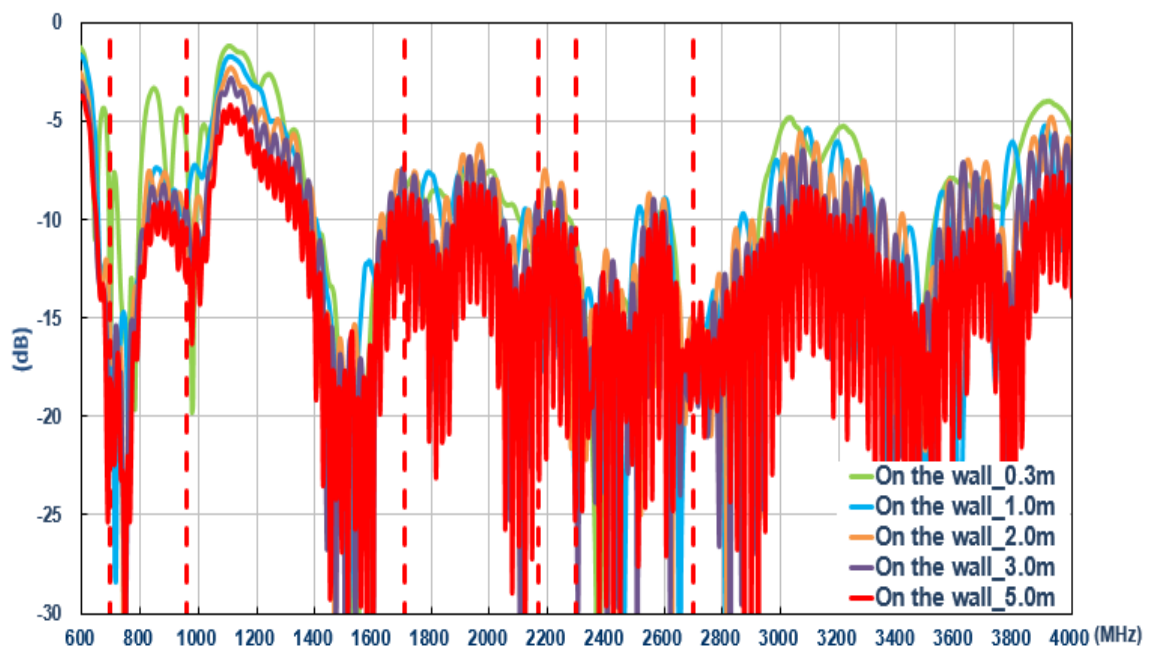

6.5.3 Isolation (LTE antenna)

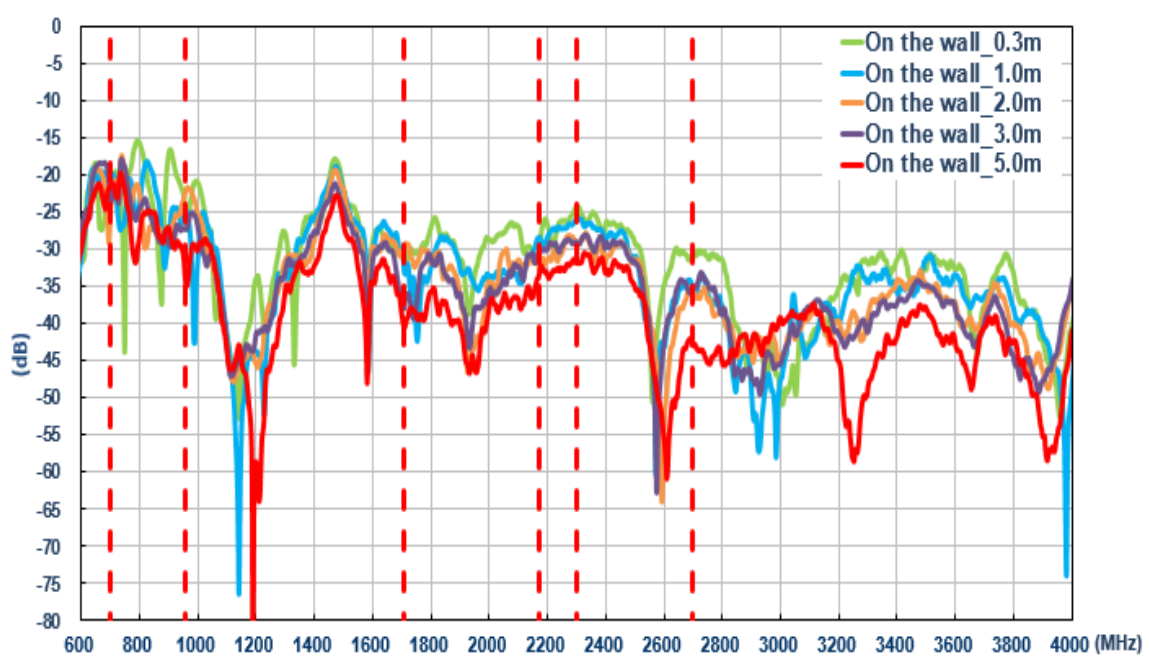

6.5.4 Efficiency (MIMO 1)

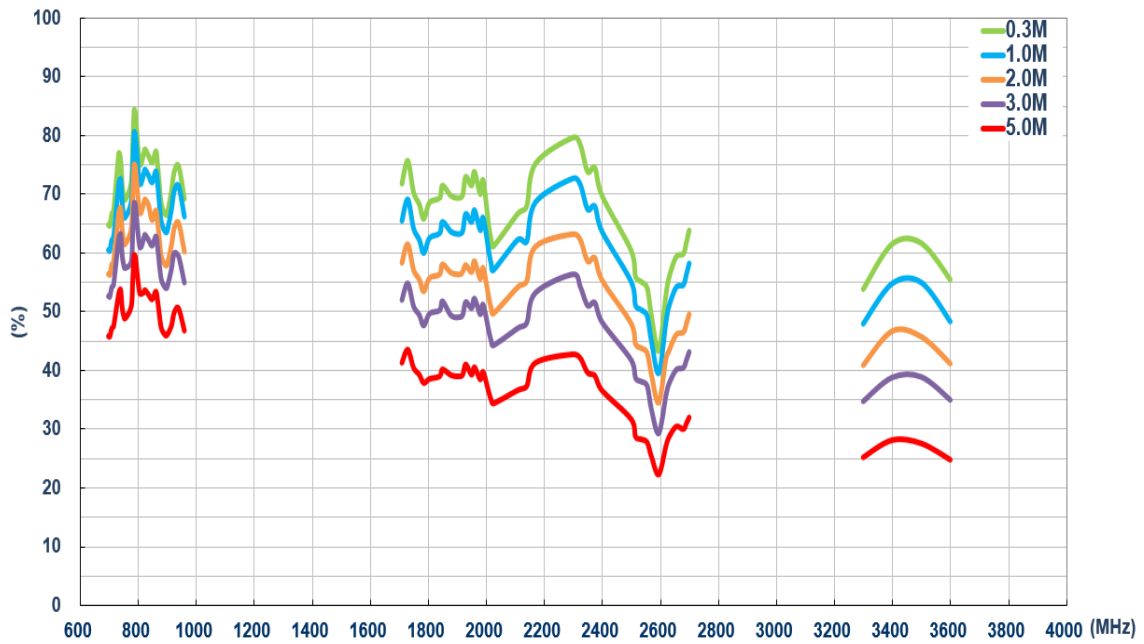

6.5.5 Efficiency (MIMO 2)

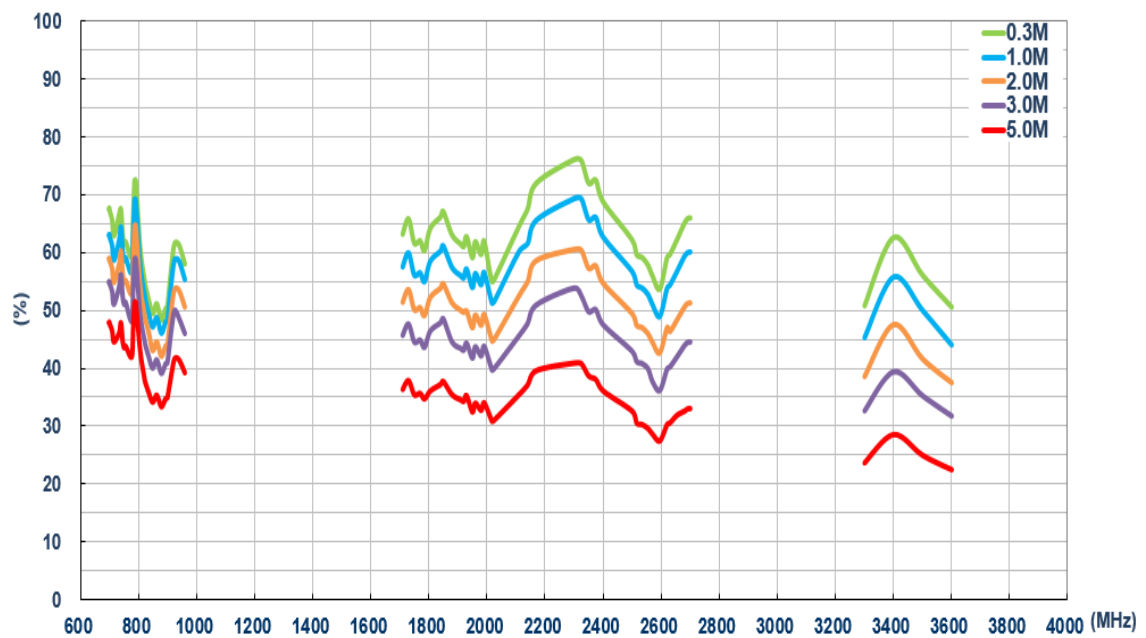

6.5.6 Average Gain (MIMO 1)

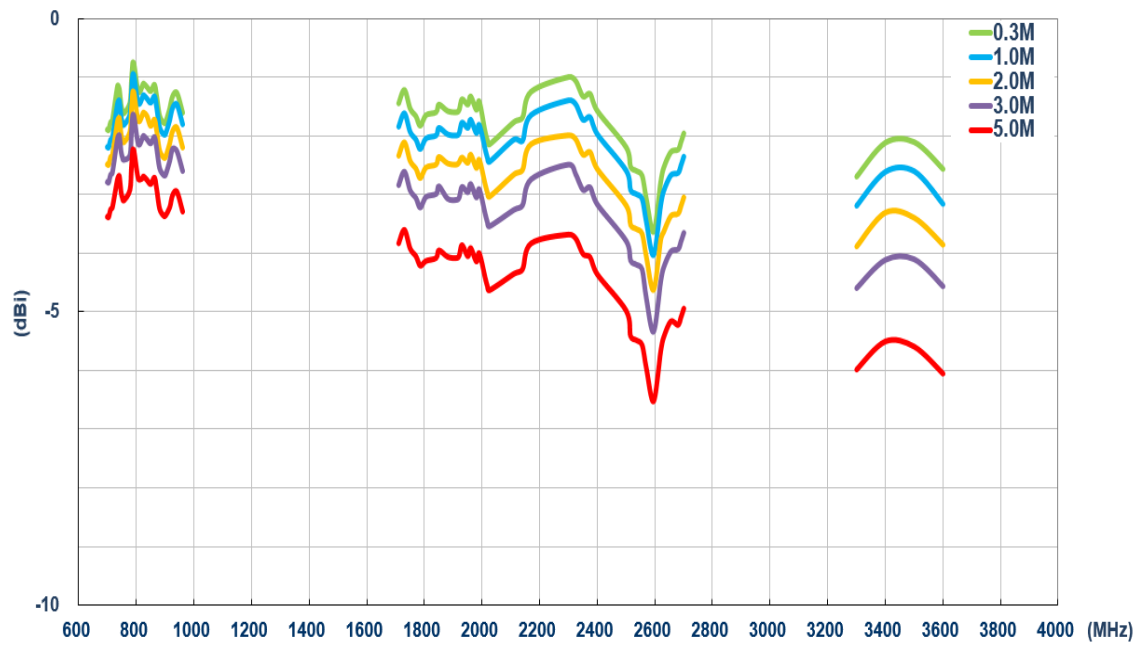

6.5.7 Average Gain (MIMO 2)

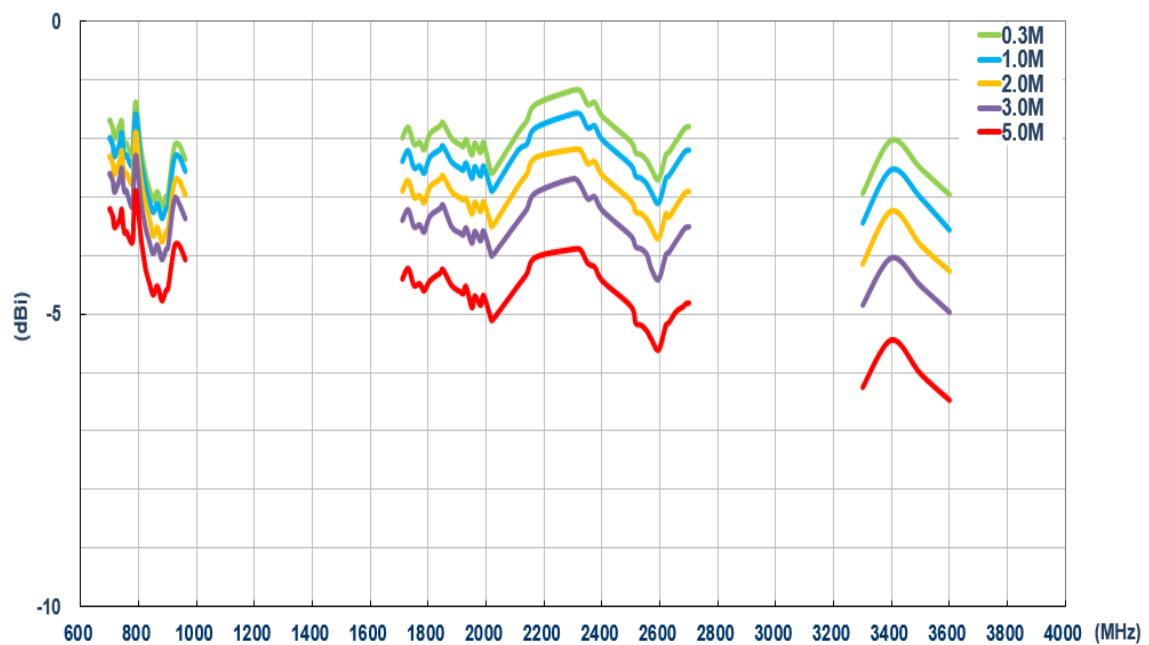

6.5.8 Peak Gain (MIMO 1)

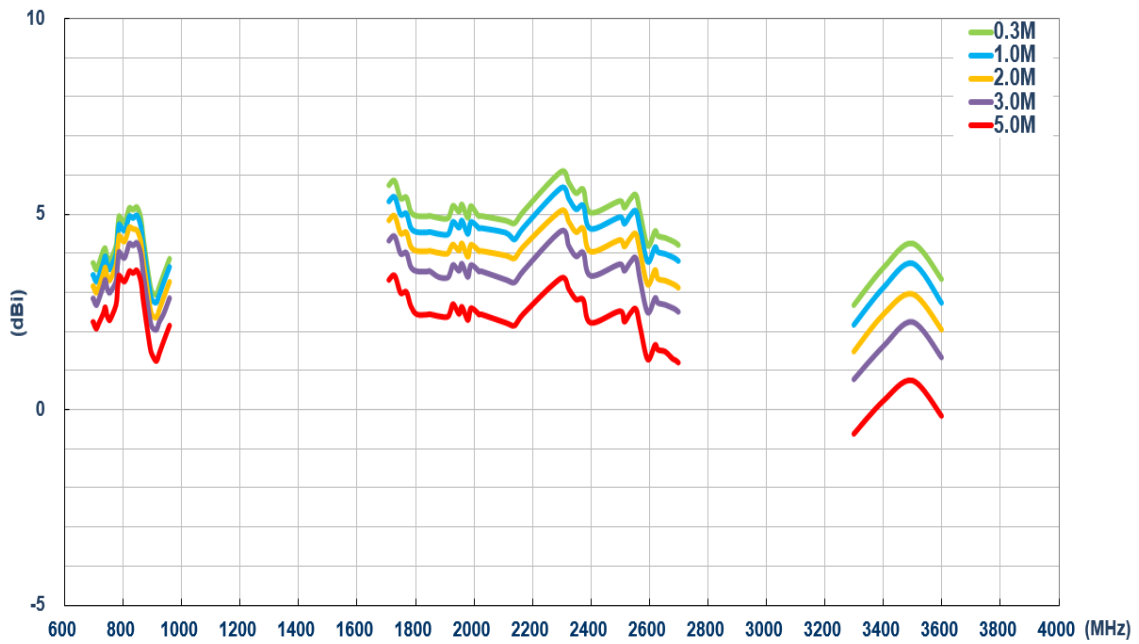

6.5.9 Peak Gain (MIMO 2)

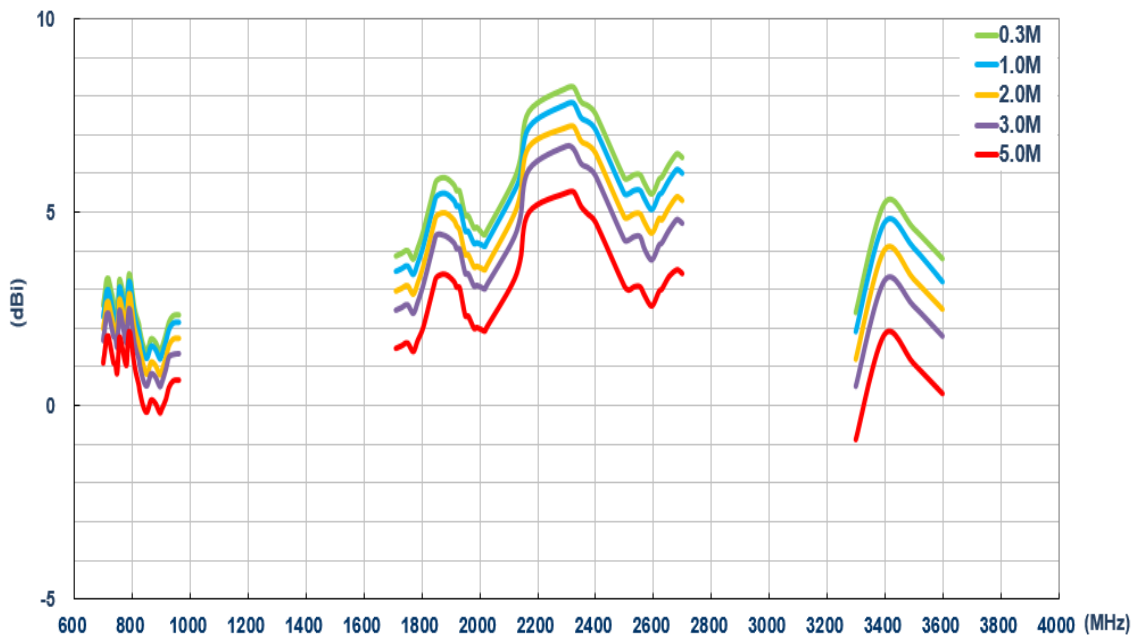

Changelog for the datasheet

SPE-17-8-085 – MA912.A.BI.001

Revision: C (Current Versions)

Date:	2022-07-18
Notes:	Updated Drawing
Author:	Cesar Sousa

Previous Revisions

Revision: B

Date:	2019-10-20
Notes:	Updated Drawing
Author:	Jack Conroy

Revision: A (Original First Release)

Date:	2017-10-11
Notes:	Initial Datasheet Release
Author:	Author