

Specification

Part No. : **MA912.W.A.BI.001**

Product : **Guardian** 2* LTE MIMO
Name 2 in 1 Adhesive Mount Antenna

Features : Low-Profile Housing – Mounts Flush to Wall
2* LTE MIMO
698 to 960MHz
1710 to 2170MHz
2490 to 2690MHz
3300 to 3600MHz
Worldwide 4G Bands including 3G and 2G
IP67 Waterproof Resistant Enclosure
Dims: 146*134*20mm
Cable: 3000mm Low Loss KSR200-P
Connector: SMA(M)
Custom Cables and Connectors Available
RoHS Compliant



1. Introduction

The MA912 Guardian is a new generation of combination antenna. It is the first panel antenna worldwide designed for IoT gateway and router devices. It is a low profile 2 in 1 wall and adhesive mount antenna. It is a heavy-duty, fully IP67 waterproof resistant external M2M antenna for use by RF professionals in:

- IoT Gateway and Routers
- HD Video Streaming
- Transportation
- Remote monitoring applications

This antenna delivers powerful MIMO antenna technology for worldwide 4G LTE bands at 698 to 960 MHz/1710 to 2170 MHz/2490 to 2690 MHz/3300 to 3600 MHz, dual-band 2.4/5.8 GHz WIFI. It enables designers to install only one antenna to cover all of these technologies.

The housing dimension is 146*134*20mm (L*W*H). It is IP67 waterproof and comes with a 3M foam adhesive. The antenna can be mounted internally or externally on a vehicle. The cables are 3 meter, low loss KSR-200P coaxial cable for the LTE antennas. Customized cables and connector versions are also available. Also available in black.

2G/3G/4G LTE Antenna									
Frequency (MHz)	LTE700	GSM850	GSM900	DCS	PCS	UMTS1	LTE2600	LTE3500	
	698~803	824~894	880~960	1710~1880	1850~1990	1920~2170	2490~2690	3300~3600	
Efficiency (%)									
MIMO_1	Free	43.92	47.52	34.92	52.65	54.62	55.40	36.80	36.43
	ABS	59.01	59.23	51.81	52.53	55.15	54.24	37.85	37.13
	Glass	58.74	57.34	53.23	52.99	55.87	53.91	38.14	37.82
	Metal	36.32	43.87	49.29	31.28	36.73	36.97	33.19	32.08
	Wall	58.74	59.92	56.46	50.65	50.54	49.08	37.66	36.87
MIMO_2	Free	46.78	50.19	41.11	48.77	53.15	52.96	40.86	37.57
	ABS	62.00	56.24	49.57	50.06	53.93	53.64	40.37	39.32
	Glass	55.75	47.40	38.25	51.45	52.81	51.02	37.42	37.04
	Metal	48.01	53.73	47.86	25.45	31.81	34.06	40.56	37.87
	Wall	53.53	41.19	44.70	45.98	43.96	43.67	40.87	34.84
Average Gain (dBi)									
MIMO_1	Free	-3.60	-3.32	-4.57	-2.79	-2.63	-2.57	-4.38	-4.41
	ABS	-2.31	-2.29	-2.86	-2.80	-2.59	-2.66	-4.26	-4.32
	Glass	-2.36	-2.43	-2.75	-2.76	-2.53	-2.69	-4.23	-4.24
	Metal	-4.57	-3.58	-3.09	-5.08	-4.36	-4.34	-4.83	-4.96
	Wall	-2.33	-2.23	-2.49	-2.96	-2.96	-3.10	-4.26	-4.34
MIMO_2	Free	-3.35	-3.02	-3.90	-3.12	-2.75	-2.77	-3.91	-4.28
	ABS	-2.10	-2.51	-3.06	-3.01	-2.68	-2.71	-3.97	-4.08
	Glass	-2.57	-3.26	-4.19	-2.89	-2.77	-2.93	-4.31	-4.32
	Metal	-3.24	-2.70	-3.22	-5.97	-4.98	-4.70	-3.94	-4.22
	Wall	-2.72	-3.85	-3.51	-3.38	-3.57	-3.61	-3.89	-4.60
Peak Gain (dBi)									
MIMO_1	Free	2.48	2.90	1.44	2.98	3.27	3.27	2.40	2.99
	ABS	3.95	3.30	2.67	4.24	4.95	4.95	3.39	1.70
	Glass	3.01	3.22	3.65	4.20	5.06	6.57	4.14	2.37
	Metal	4.39	2.40	3.93	3.50	3.86	4.59	4.82	3.48
	Wall	4.04	4.27	2.97	4.44	3.74	3.74	3.88	2.25
MIMO_2	Free	5.13	2.96	1.87	2.68	2.91	2.91	2.57	2.57
	ABS	3.63	3.82	3.61	3.26	3.63	4.59	4.44	4.02
	Glass	2.42	2.44	0.56	3.89	4.79	4.82	4.98	3.02
	Metal	2.84	2.41	2.63	2.12	3.26	3.82	5.96	3.45
	Wall	2.51	1.07	1.35	4.41	4.41	6.10	4.80	3.24
Impedance			50Ω						
Polarization			Linear						
VSWR			< 3						
Cable			3 meter KSR-200P standard, fully customizable						
Connector			SMA(M) standard, fully customizable						

2. Specification

MECHANICAL	
Antenna Dimensions	146*134*20mm
Casing	ASA
Weight (including cable)	672g
Ingress Protection Rating	IP67
ENVIRONMENTAL	
Operation Temperature	-40°C to 85°C
Storage Temperature	-40°C to 90°C
Humidity	Non-condensing 65°C 95% RH

3. Antenna Characteristics

3.1 LTE MIMO Antenna

3.1.1 Test Setup

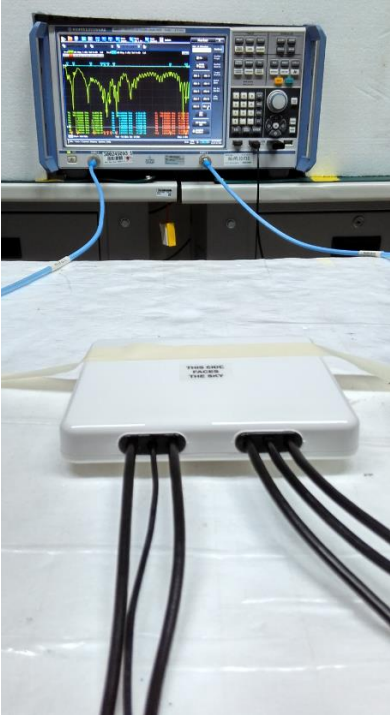

Free space



ABS

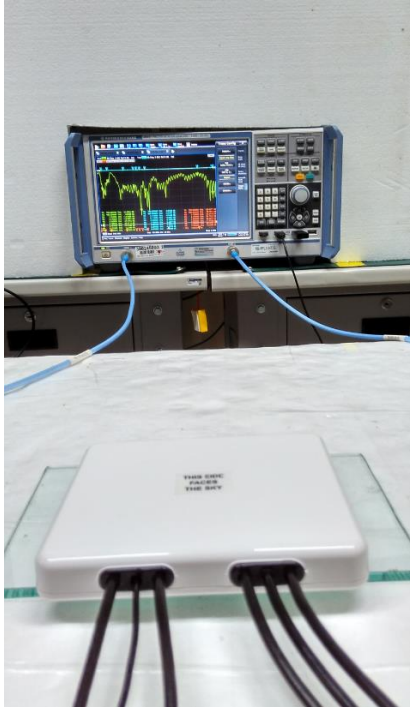

Glass

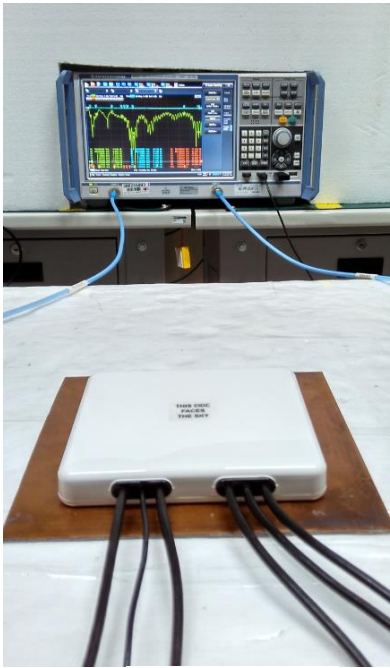

Metal



Wall

3.1.2 LTE 1 Antenna Return Loss

Performance in different environments with 3 meter cable length

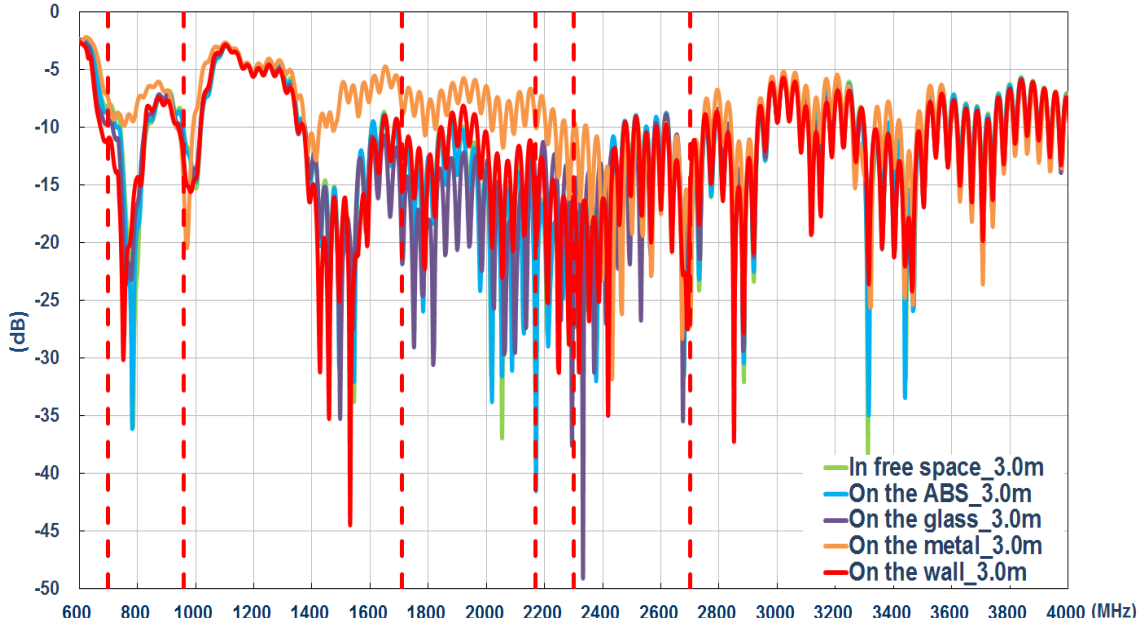

3.1.3 LTE 2 Antenna Return Loss

Performance in different environments with 3 meter cable length

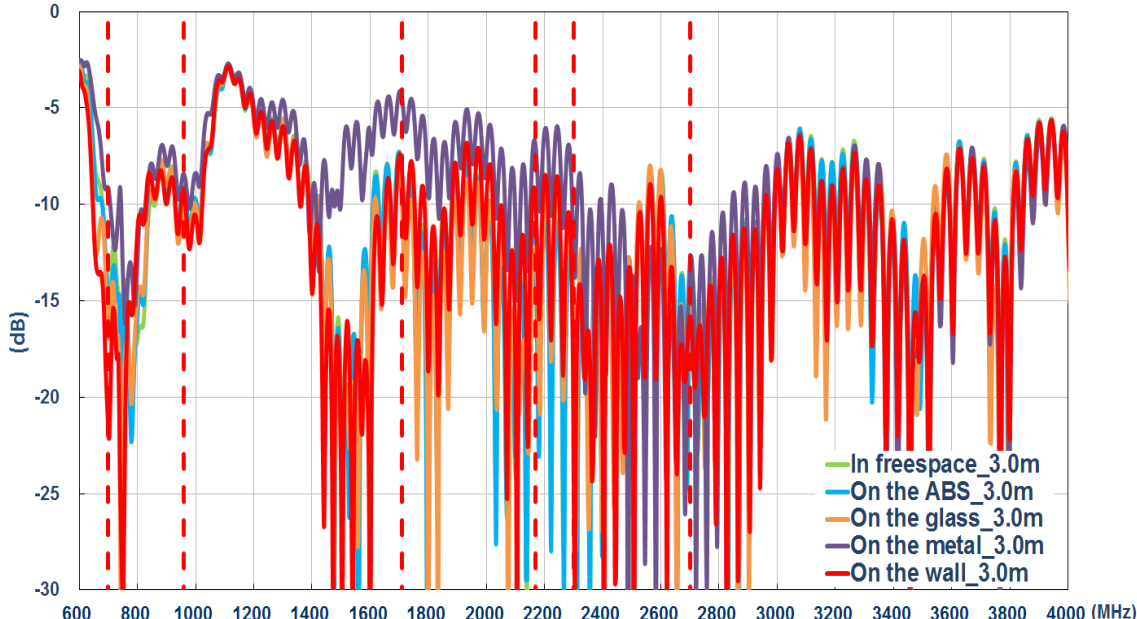

3.1.4 LTE Envelope Correlation Coefficient
Performance in different environments with 3 meter cable length

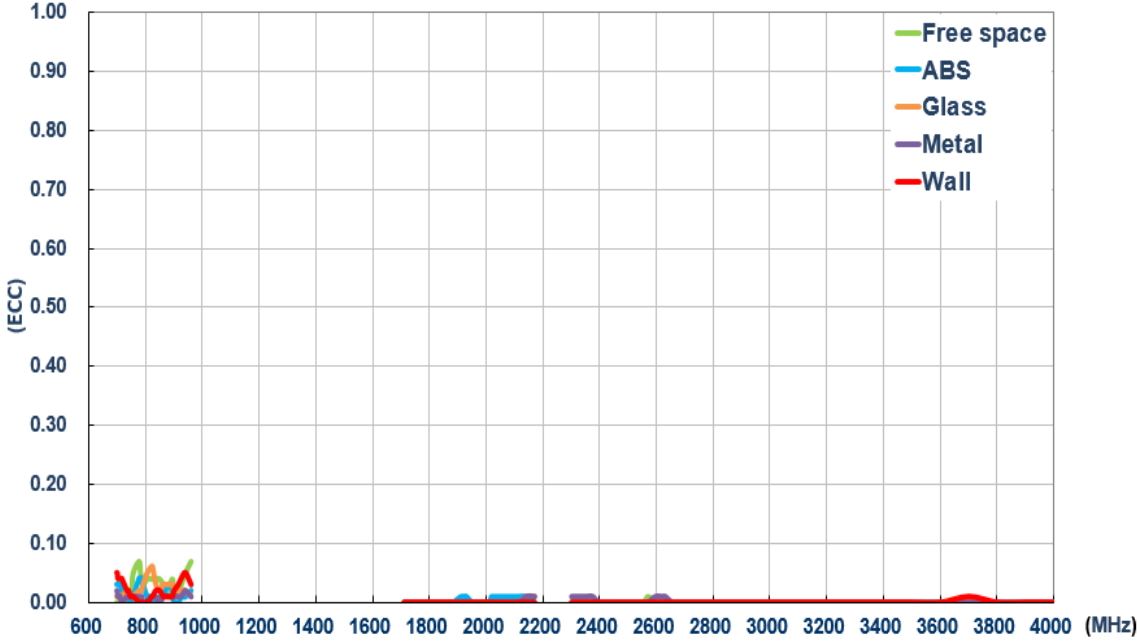

3.1.5 LTE 1 Antenna Efficiency
Performance in different environments with 3 meter cable length

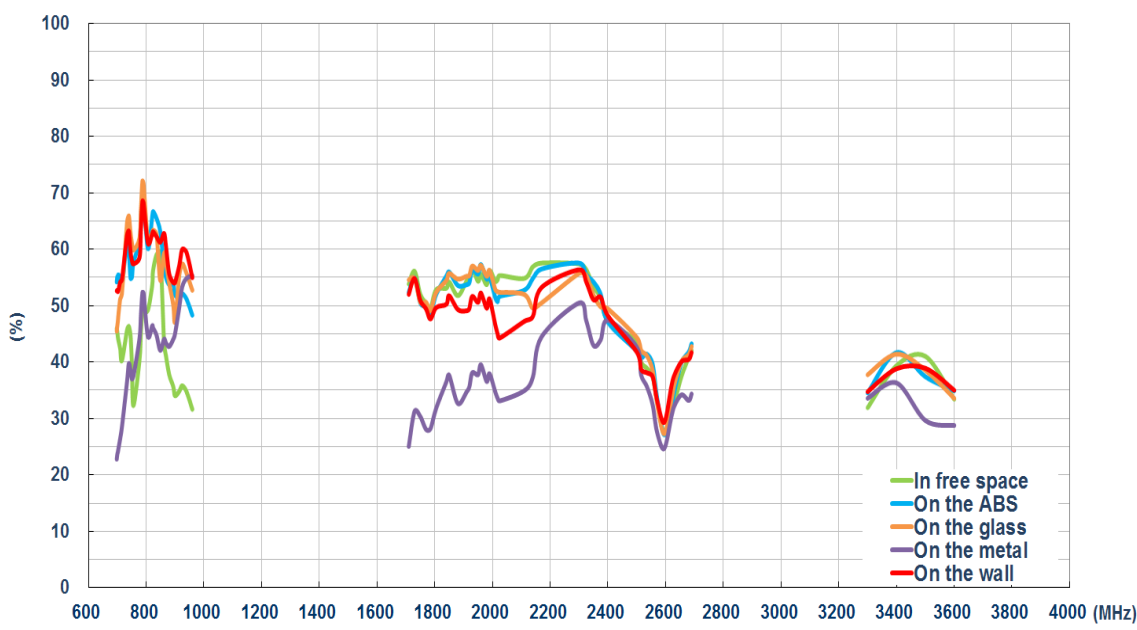

3.1.6 LTE 2 Antenna Efficiency

Performance in different environments with 3 meter cable length

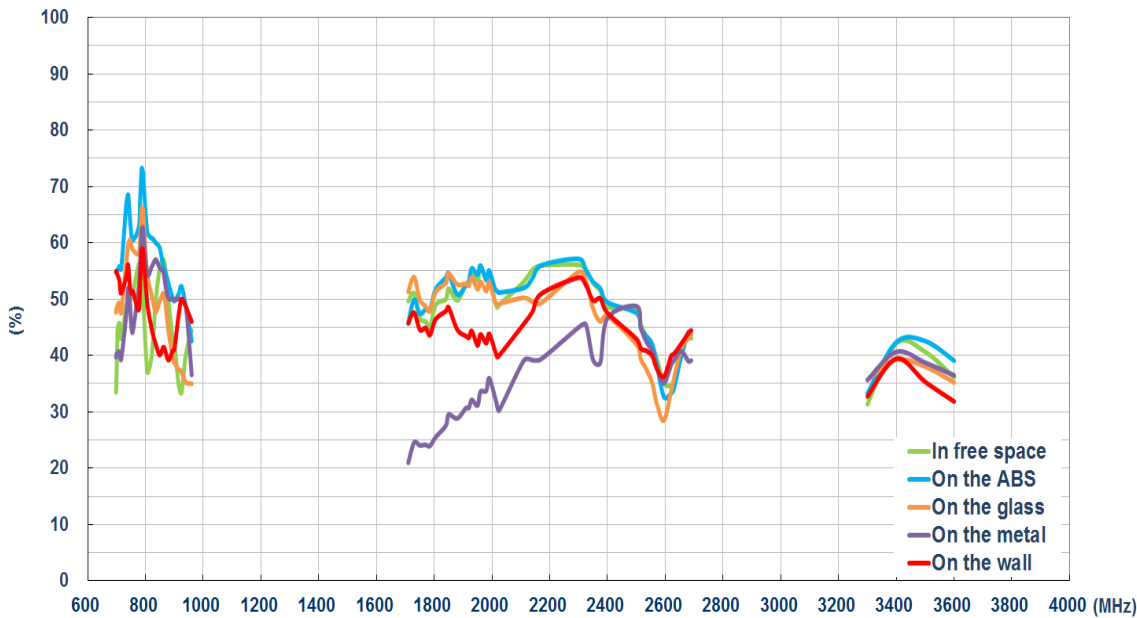

3.1.7 LTE 1 Antenna Average Gain

Performance in different environments with 3 meter cable length

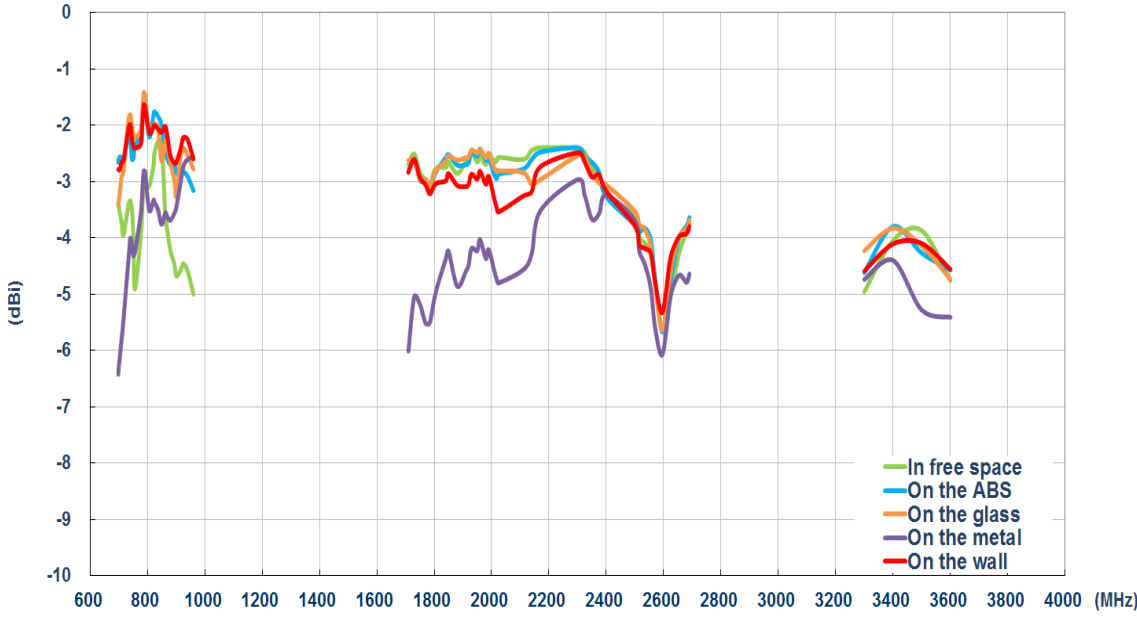

3.1.8 LTE 2 Antenna Average Gain

Performance in different environments with 3 meter cable length

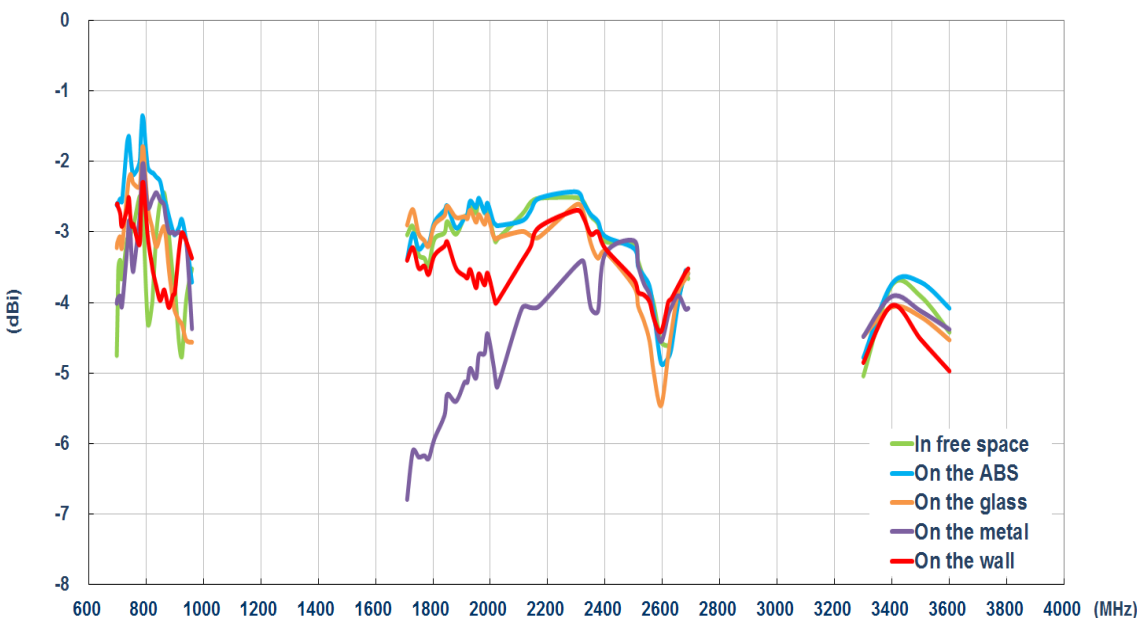

3.1.9 LTE 1 Antenna Peak Gain

Performance in different environments with 3 meter cable length

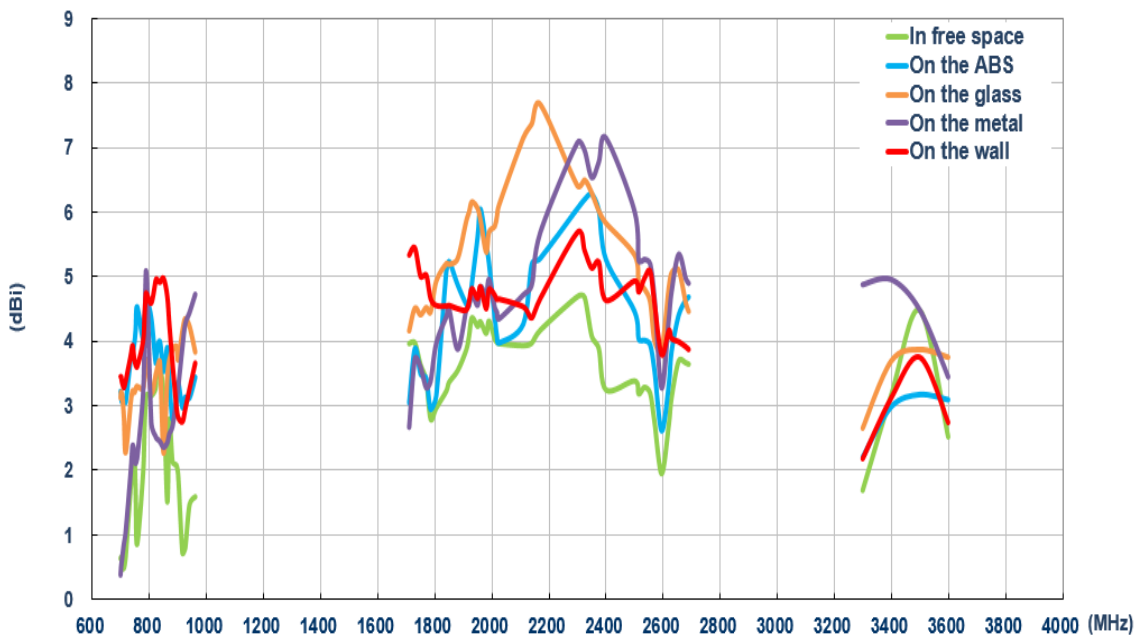

3.1.10 LTE 2 Antenna Peak Gain

Performance in different environments with 3 meter cable length

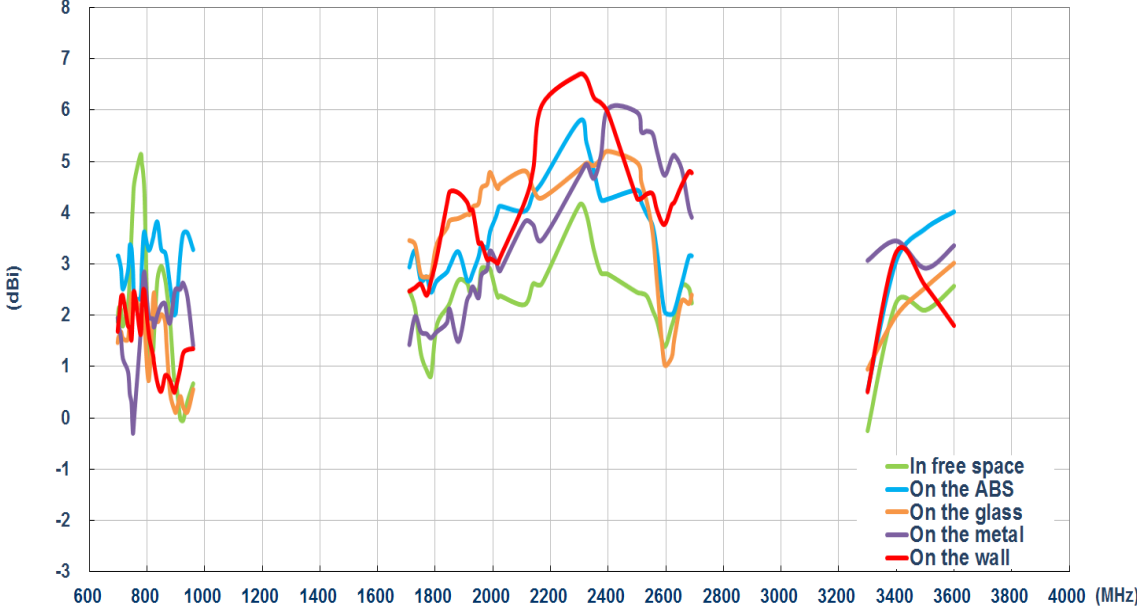

3.1.11 Test Setup For Antenna Radiation Pattern

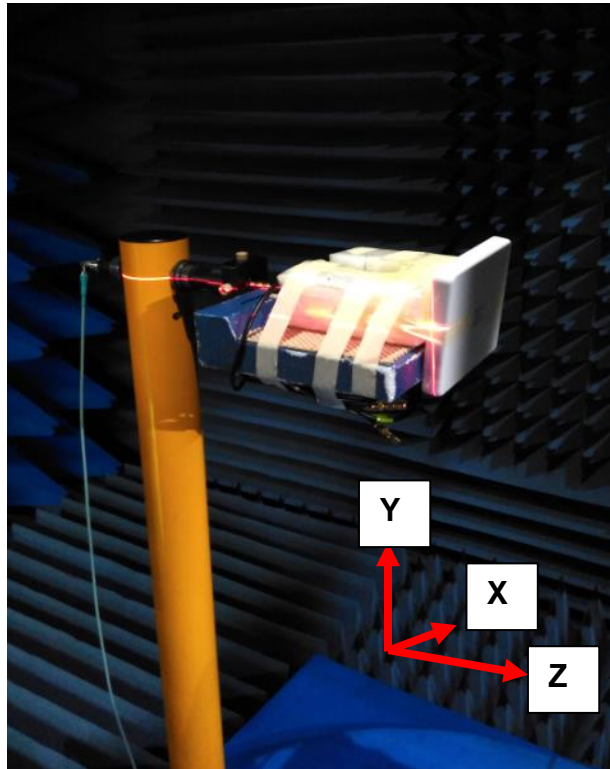

In free space

3.1.12 2D Radiation Pattern
 LTE MIMO1 with 3M cable length in free space

XY Plane

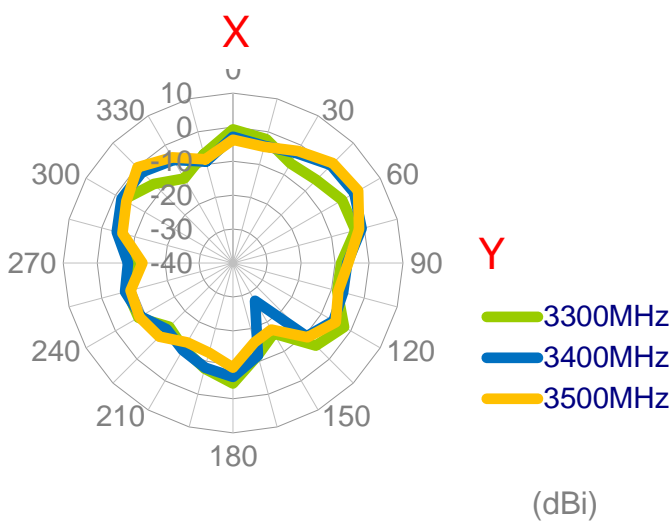
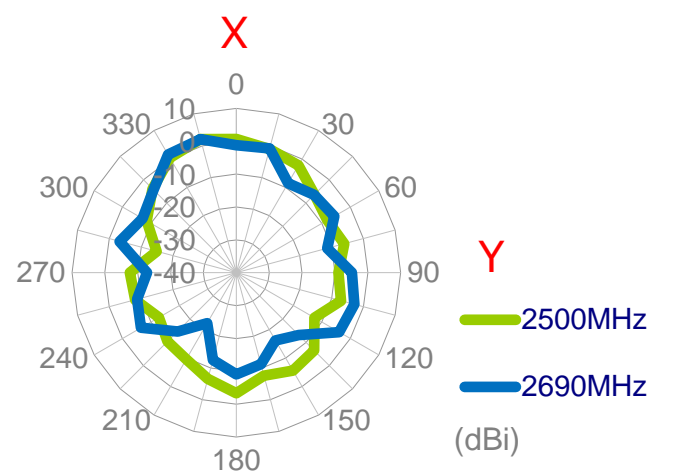
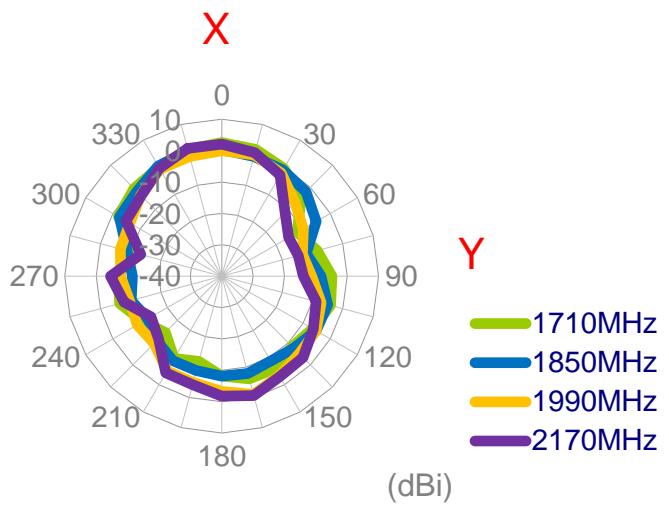
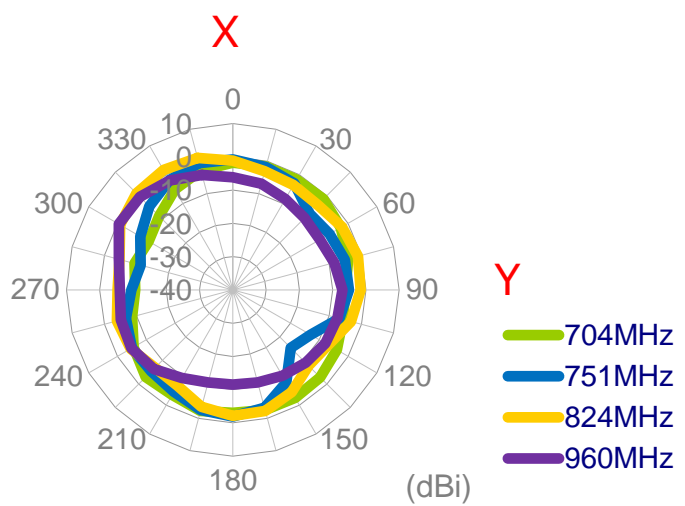

XZ Plane

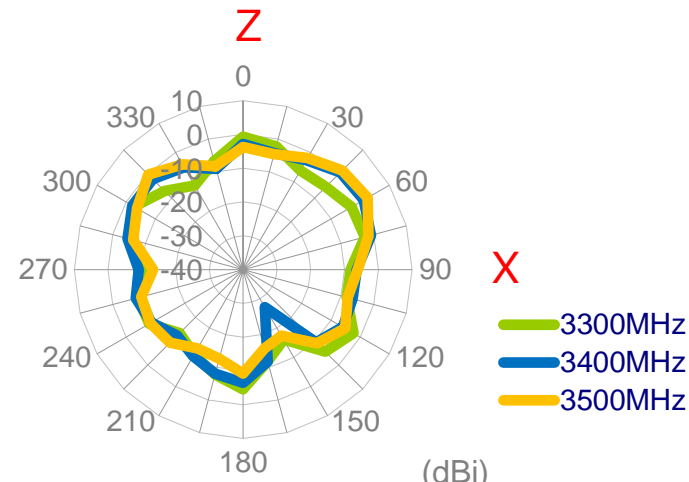
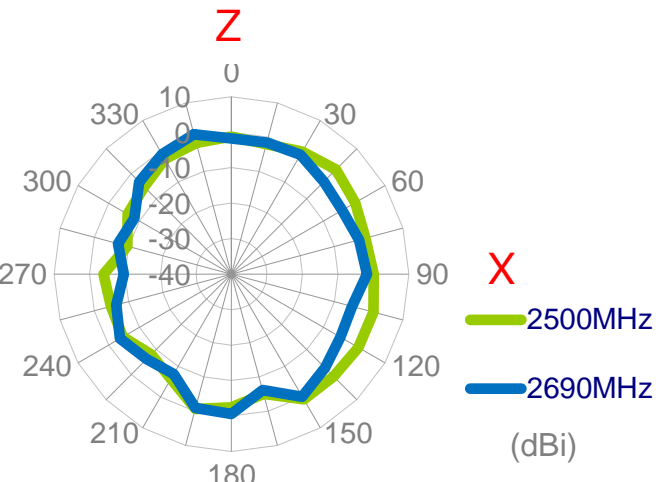
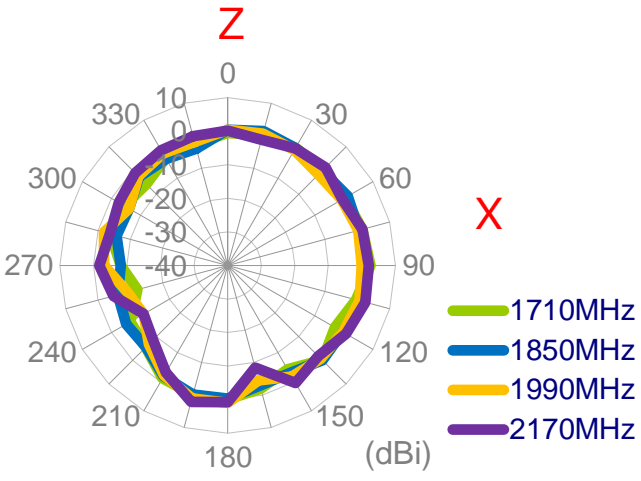
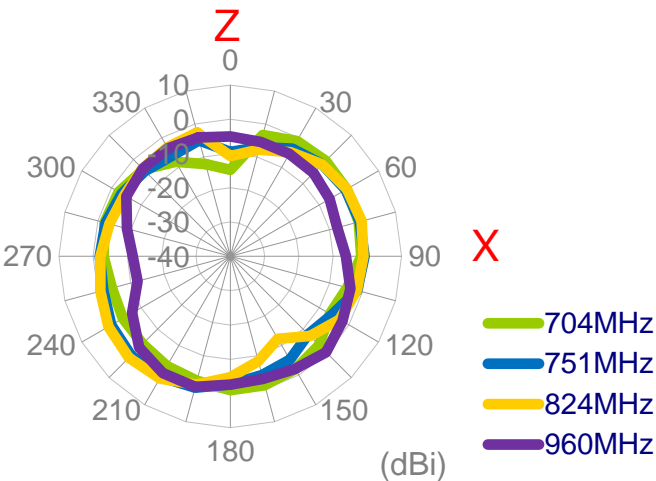

YZ Plane

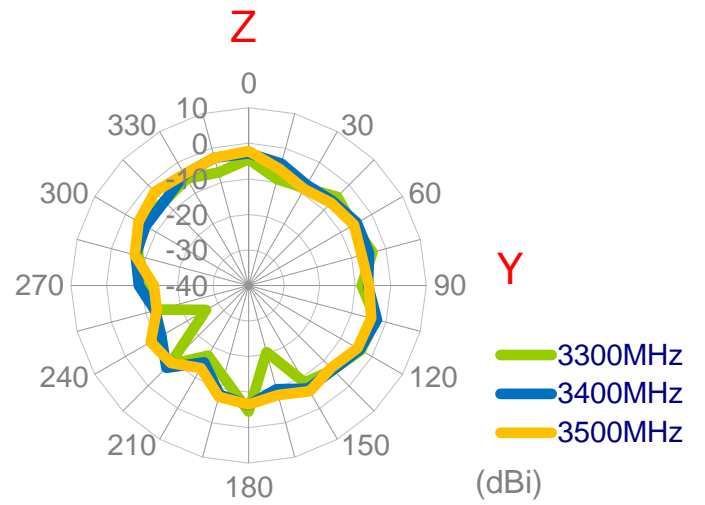
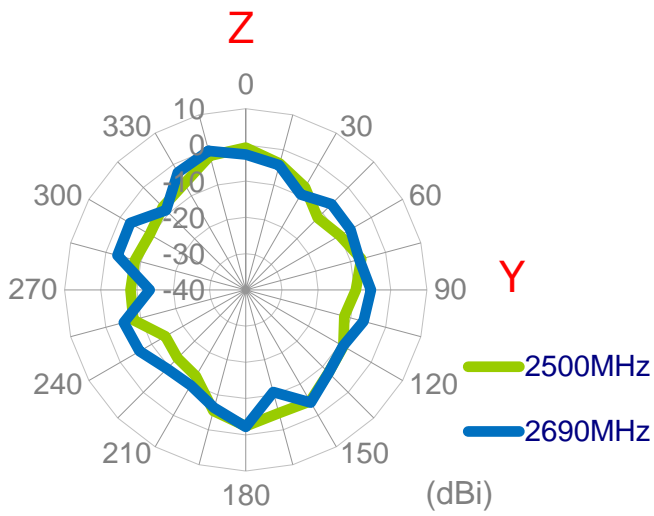
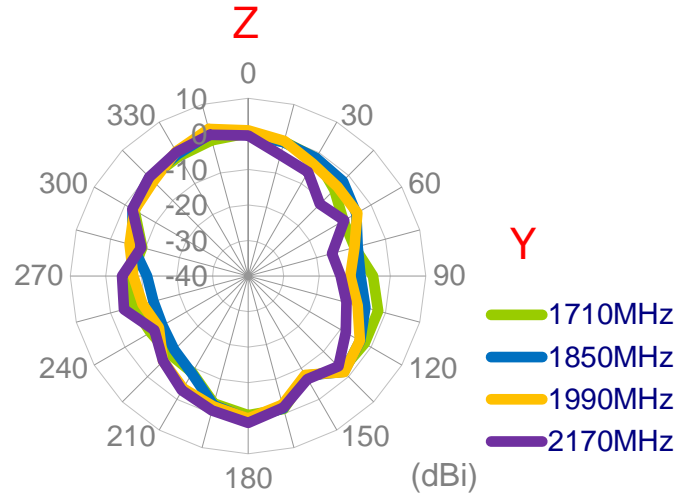
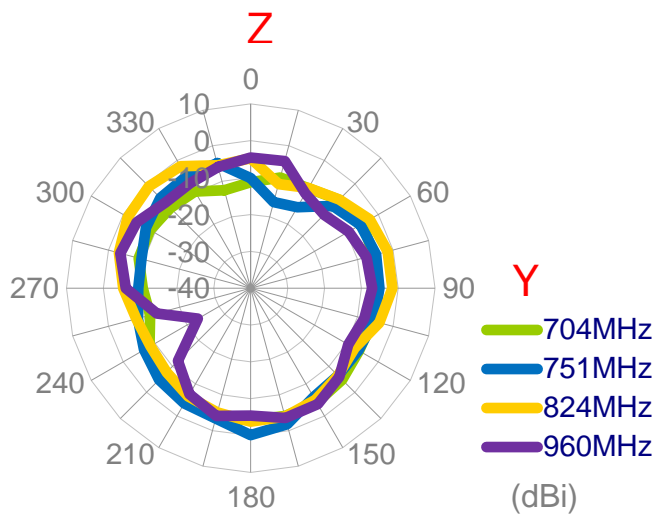

3.1.13 3D Radiation Pattern
 LTE MIMO1 with 3M cable length in free space

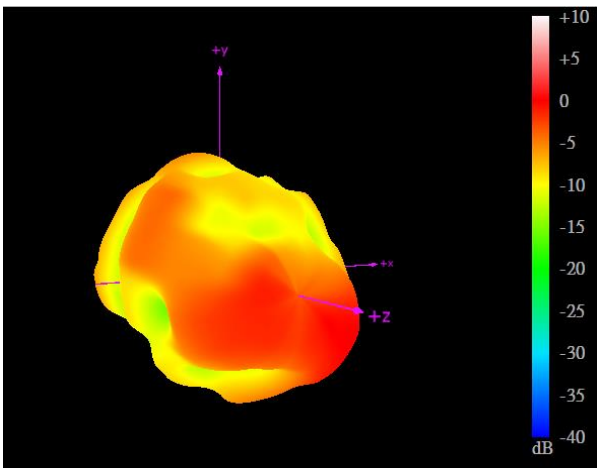

704MHz

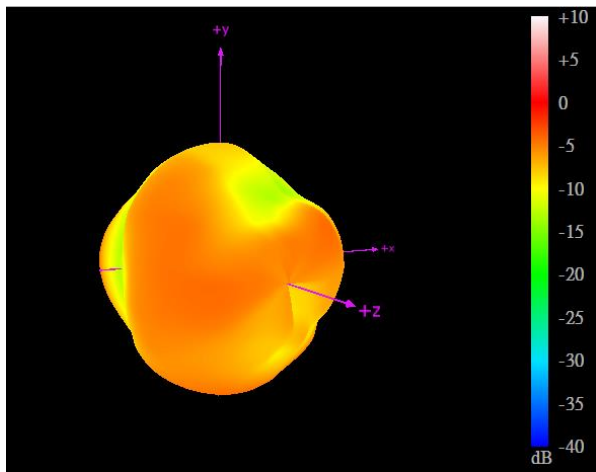

960MHz

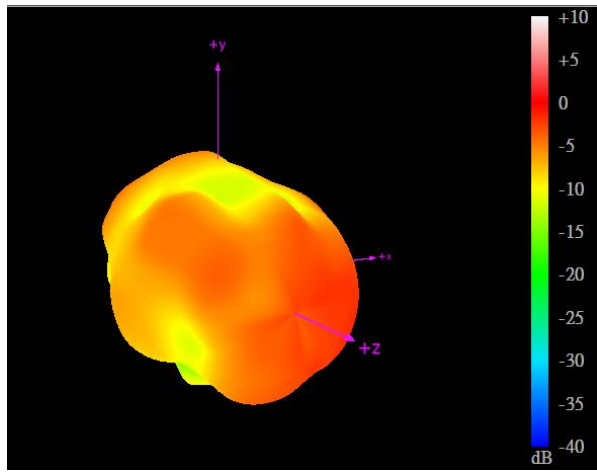

2690MHz

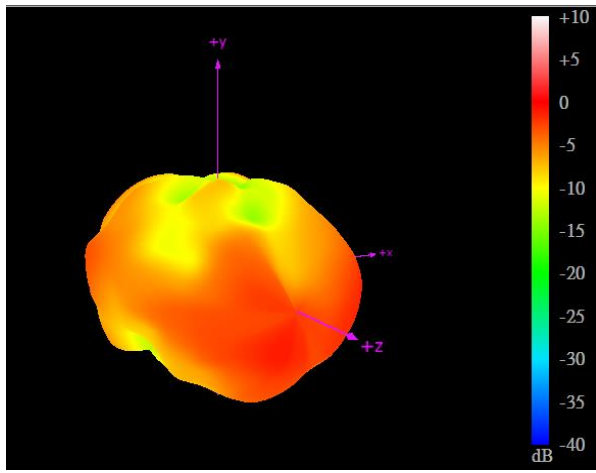

2170MHz

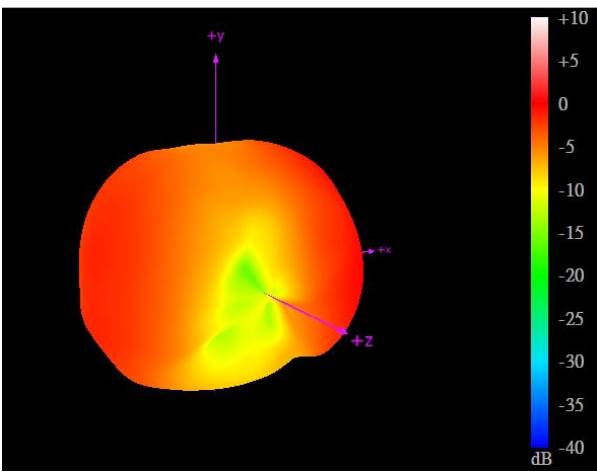

1710MHz

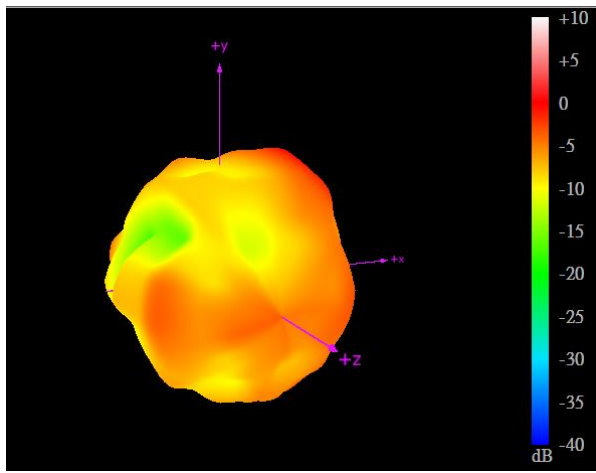

3500MHz

3.1.14 2D Radiation Pattern
 LTE MIMO2 with 3M cable length in free space

XY Plane

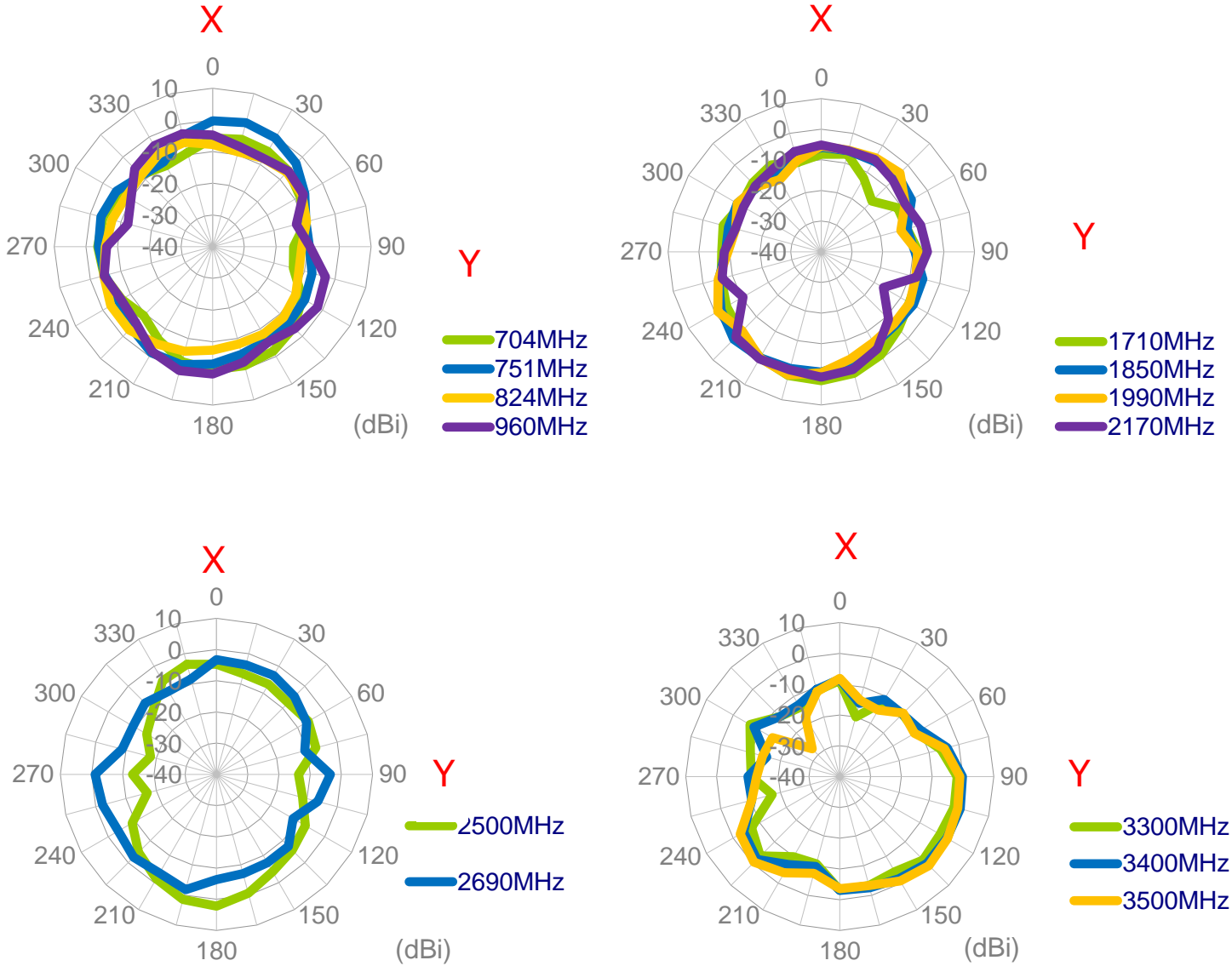

XZ Plane

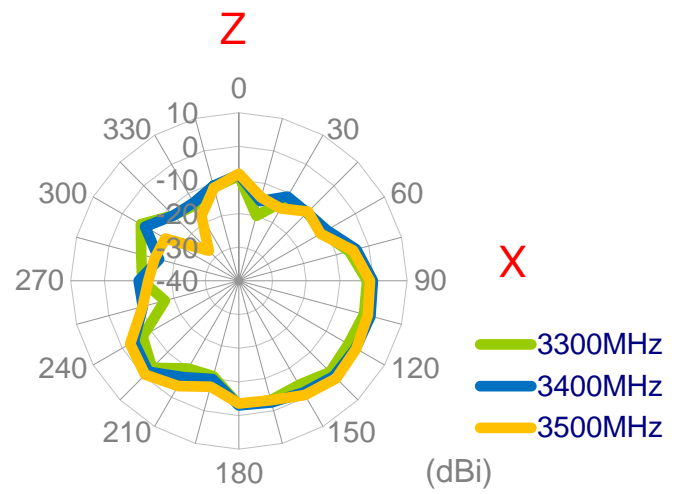
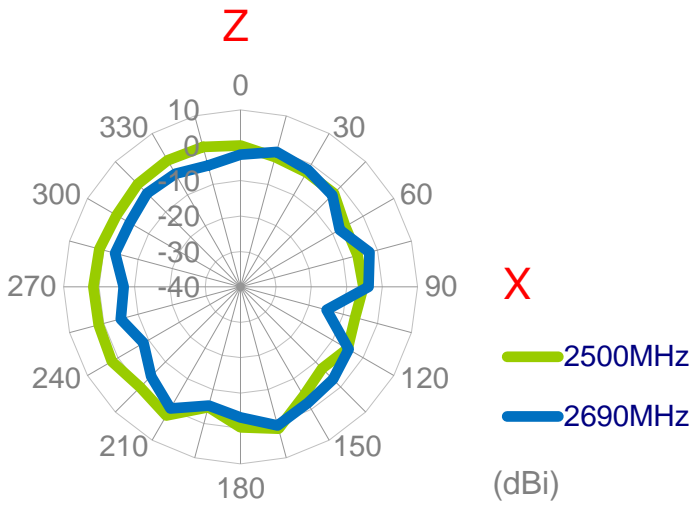
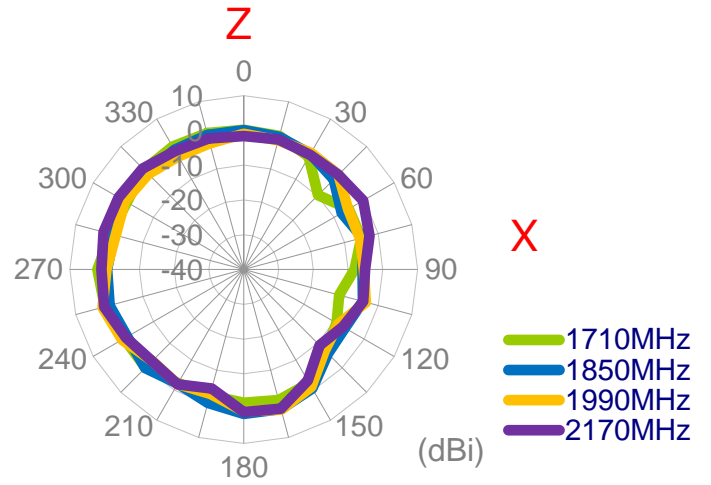
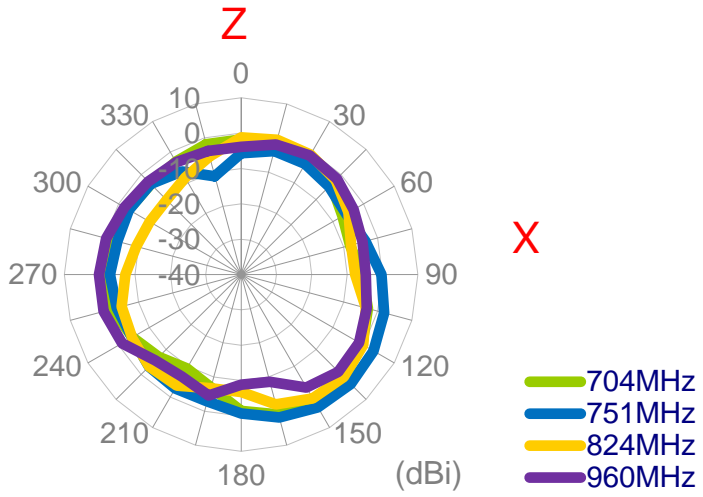

YZ Plane

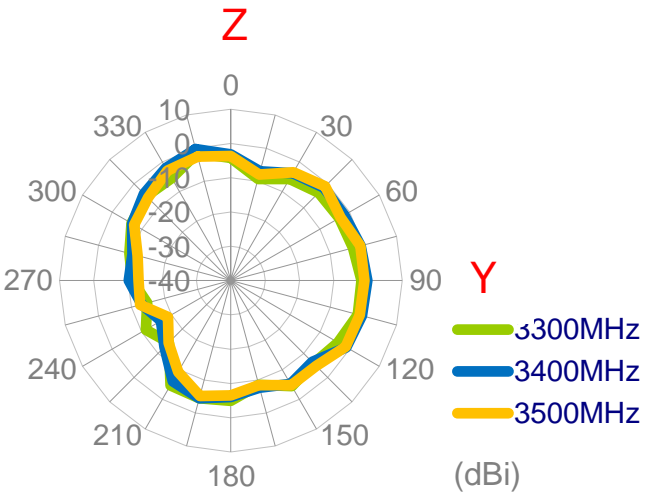
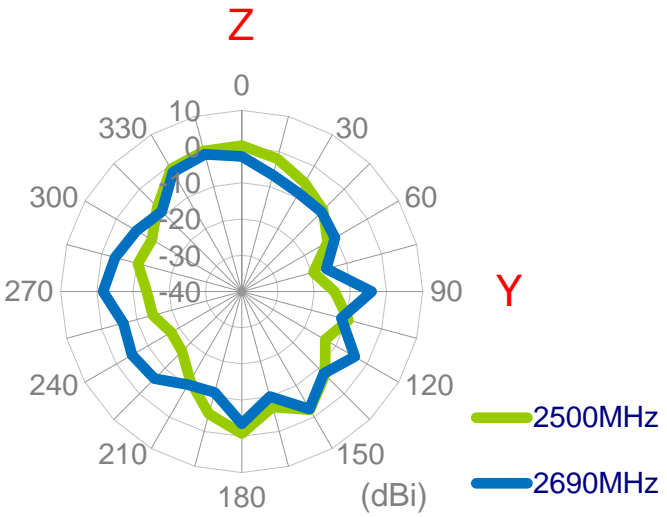
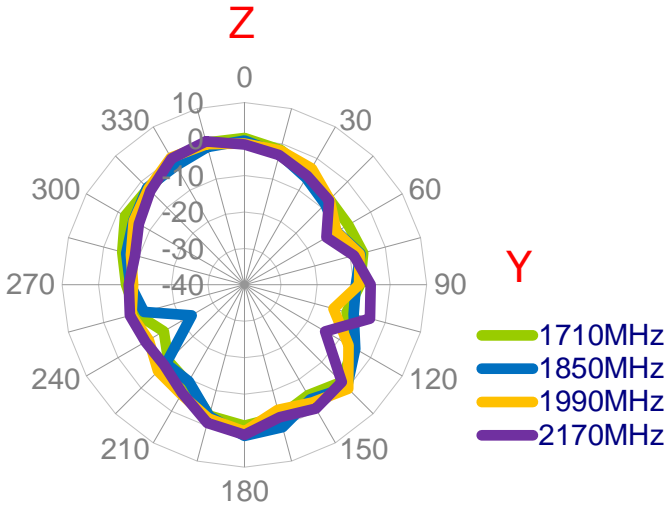
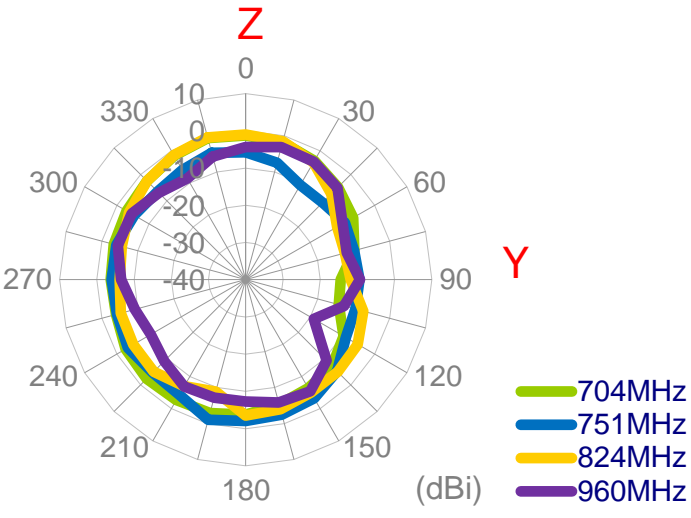

3.1.15 3D Radiation Pattern
 LTE MIMO2 with 3M cable length in free space

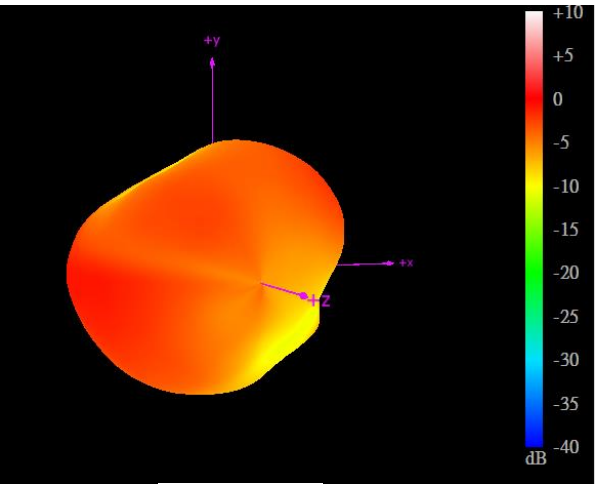

704MHz

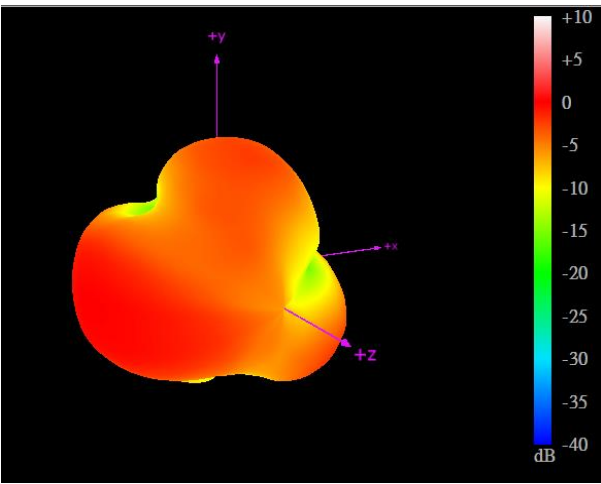

960MHz

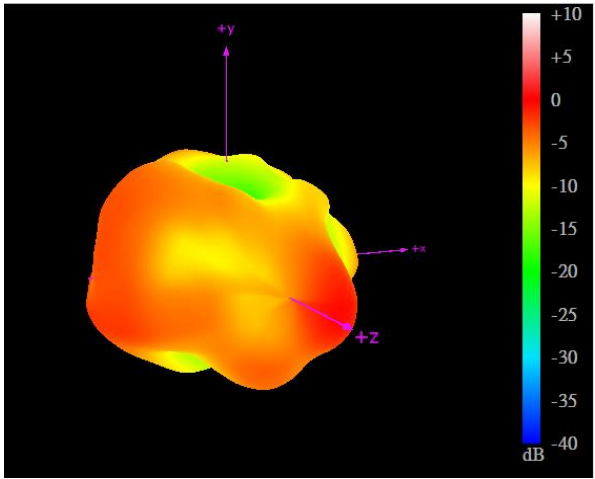

1710MHz

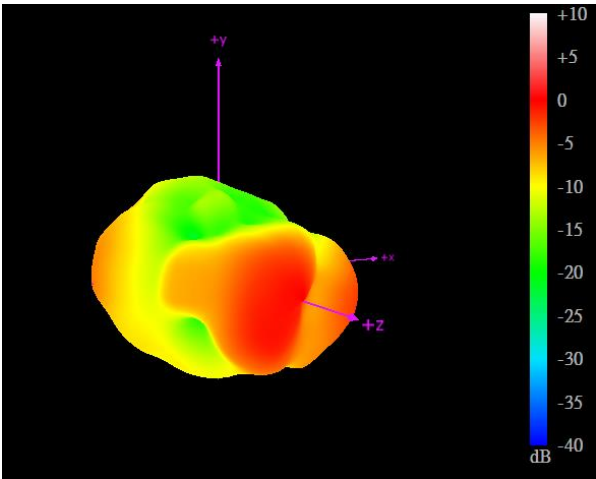

2170MHz

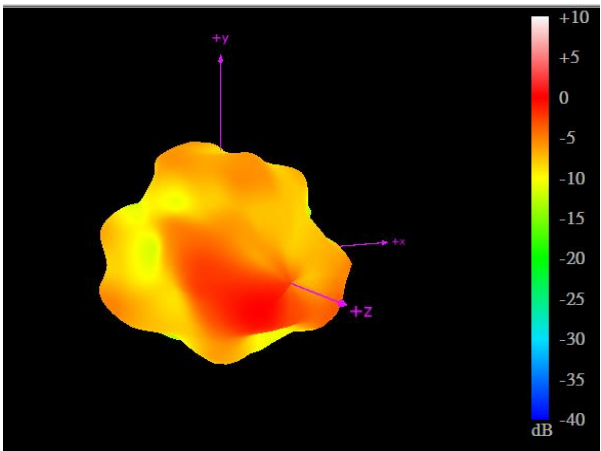

2690MHz

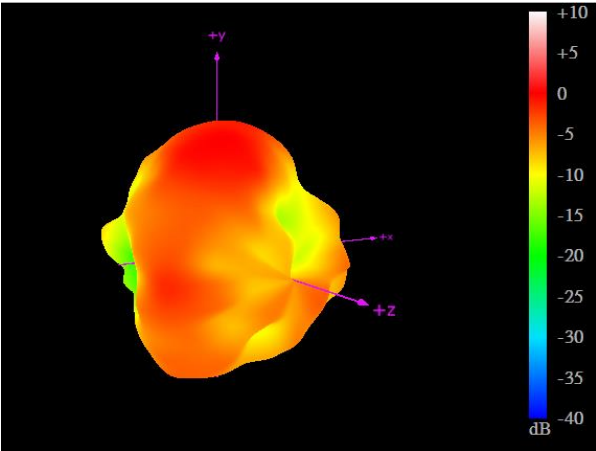

3500MHz

3.1.16 Test Setup for Antenna Radiation Pattern

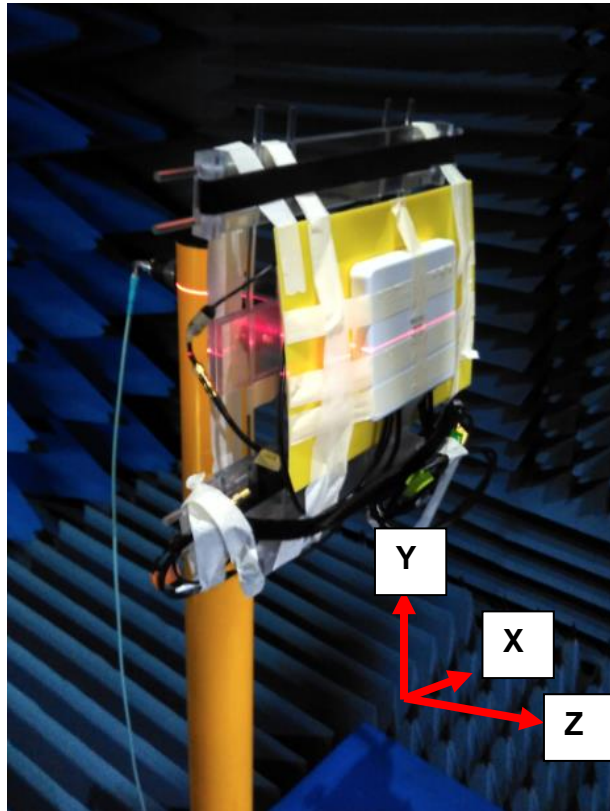

On the ABS

3.1.17 2D Radiation Pattern
 LTE MIMO1 with 3M cable length on the ABS

XY Plane

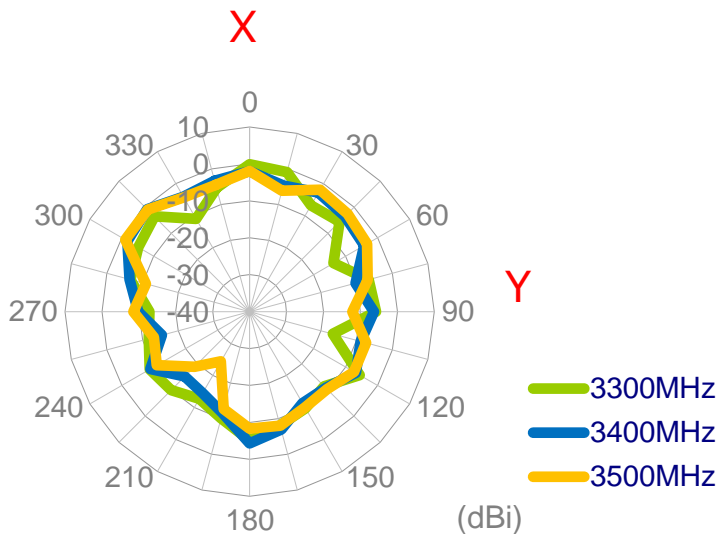
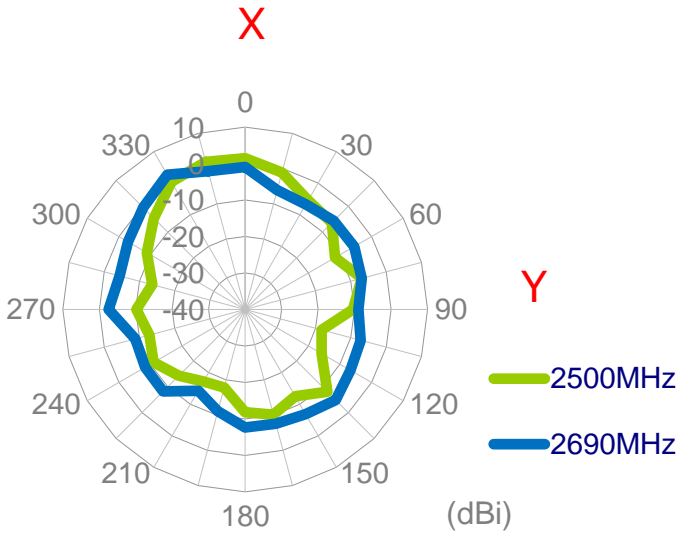
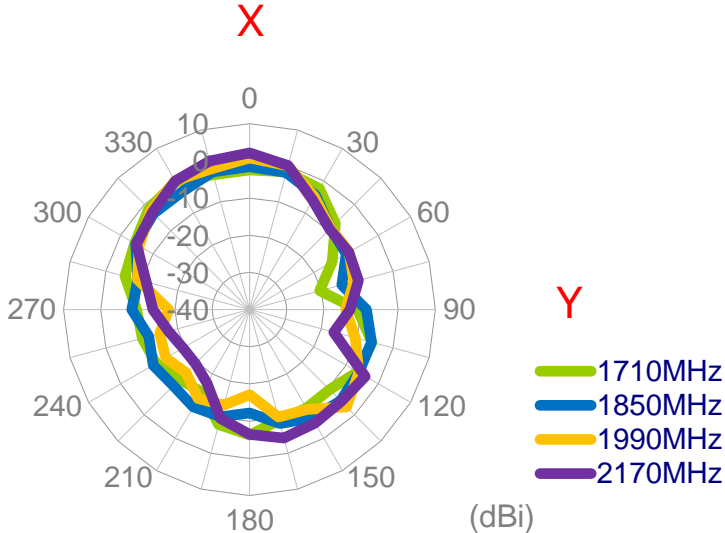
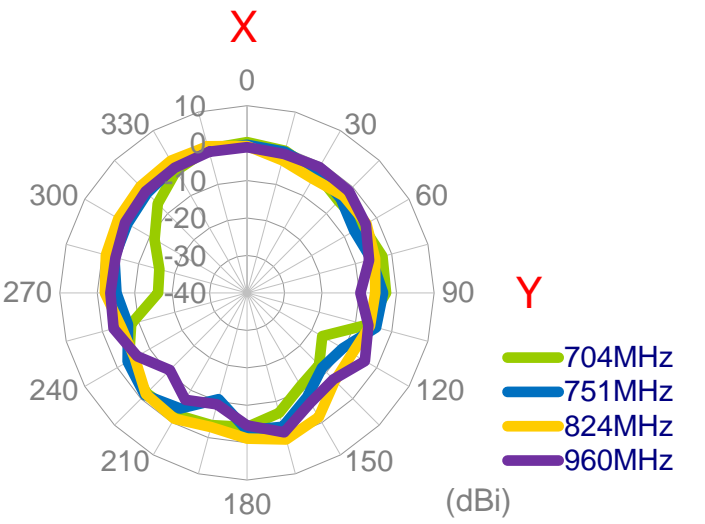

XZ Plane

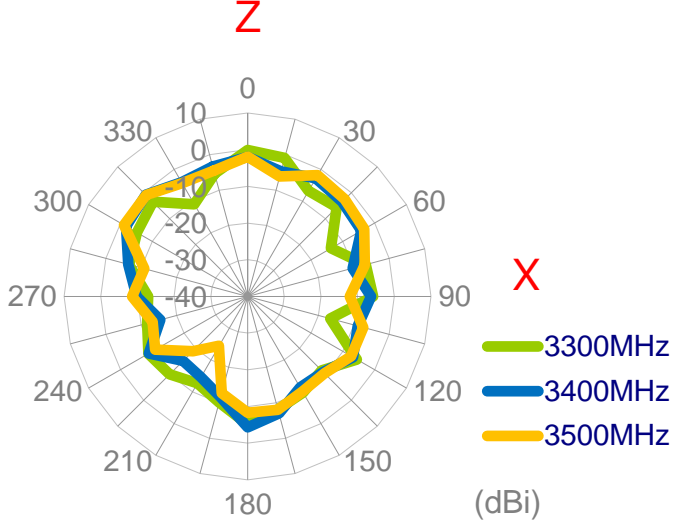
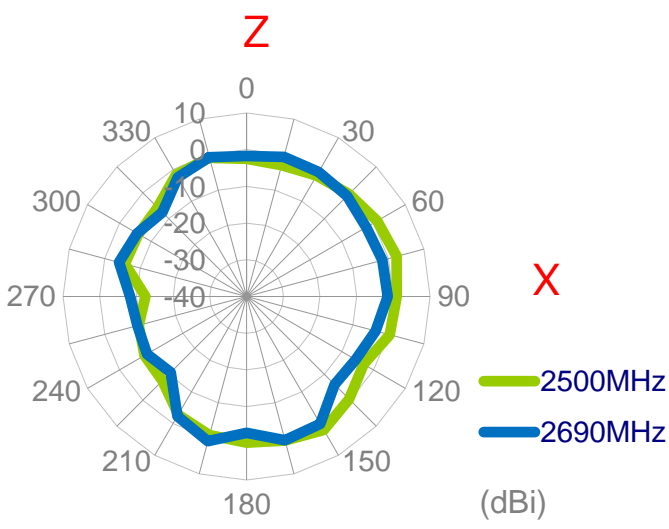
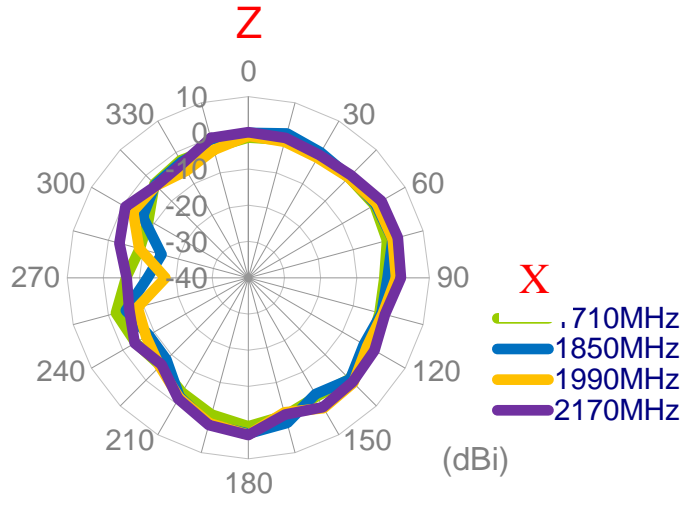
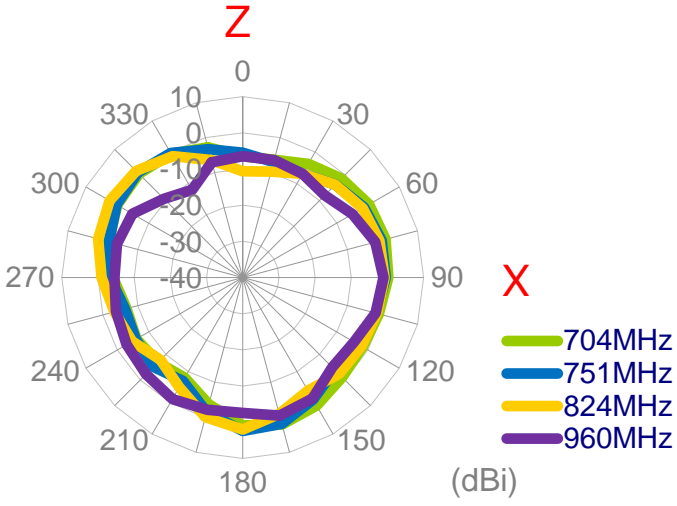

YZ Plane

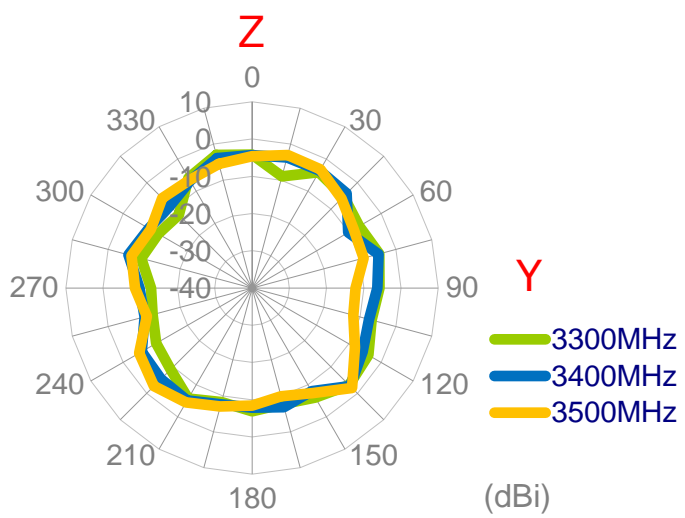
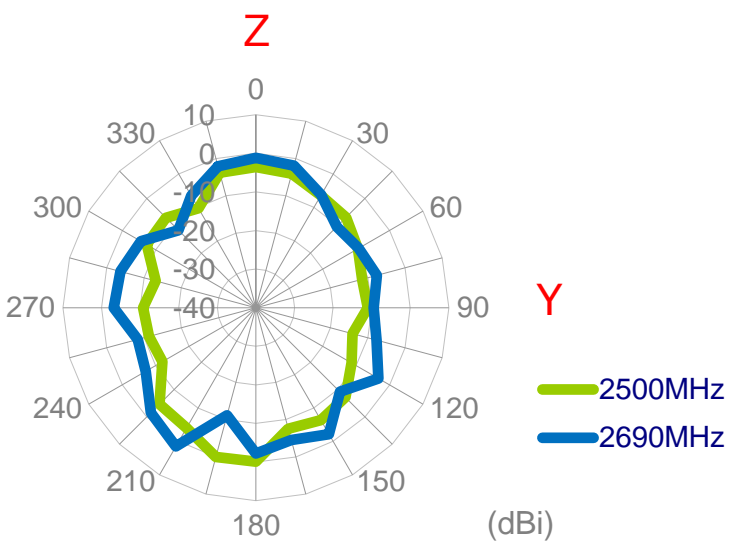
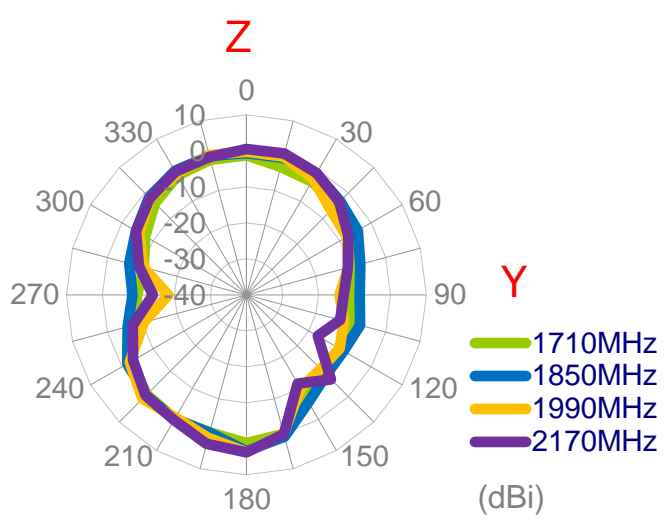
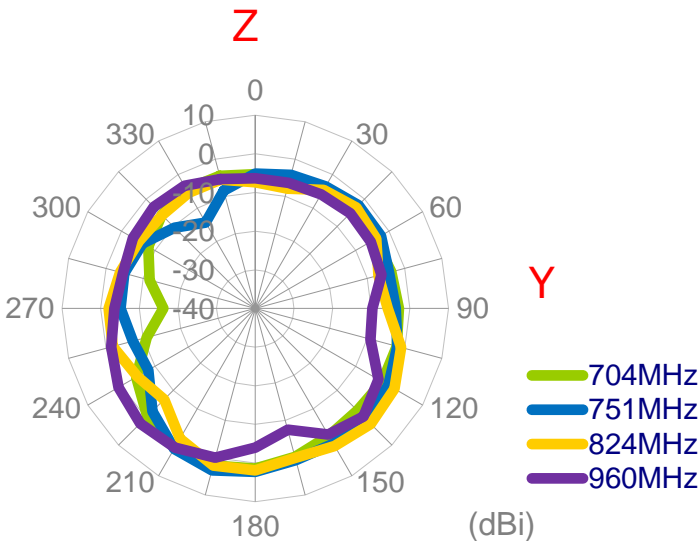

3.1.18 3D Radiation Pattern
 LTE MIMO1 with 3M cable length on the ABS

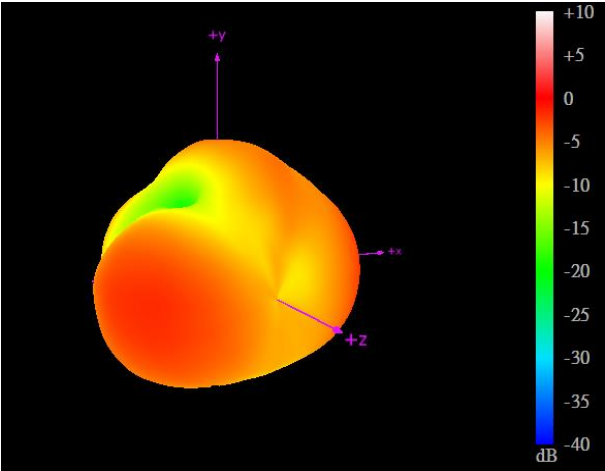

704MHz

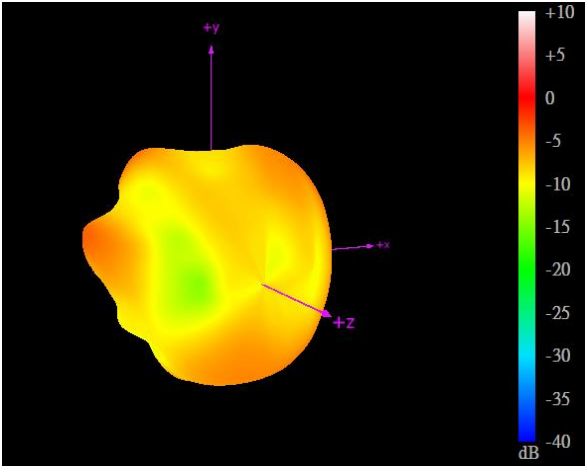

960MHz

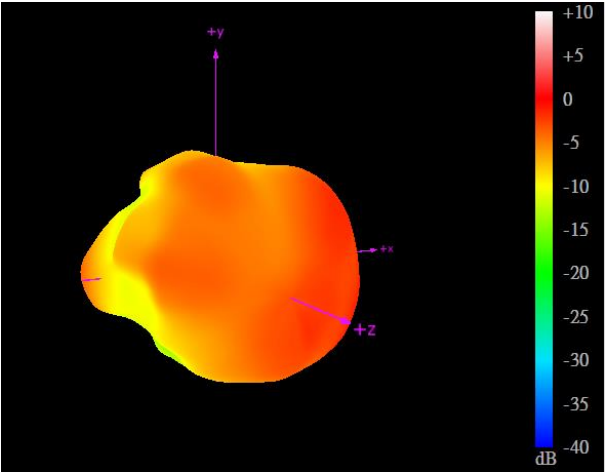

1710MHz

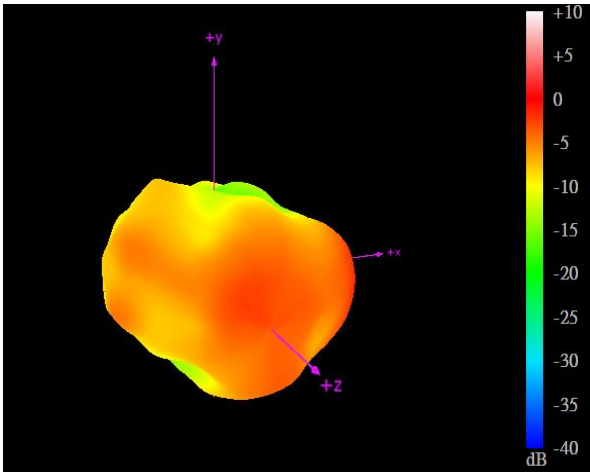

2170MHz

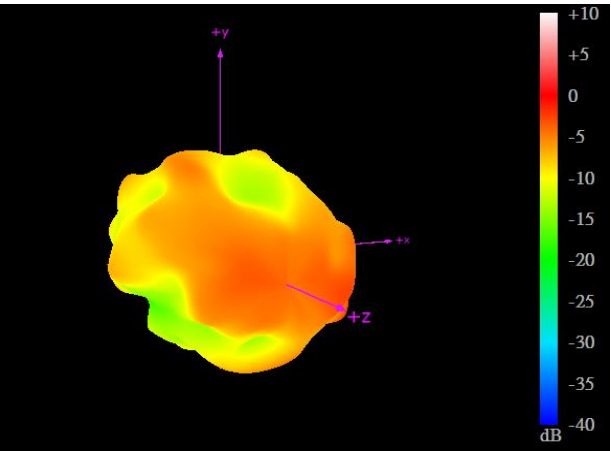

2690MHz

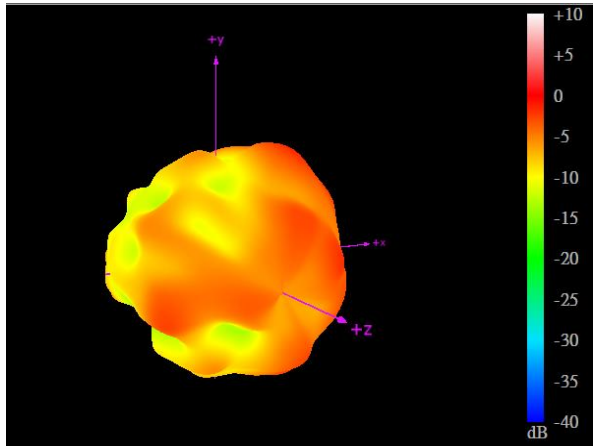

3500MHz

3.1.19 2D Radiation Pattern
 LTE MIMO2 with 3M cable length on the ABS

XY Plane

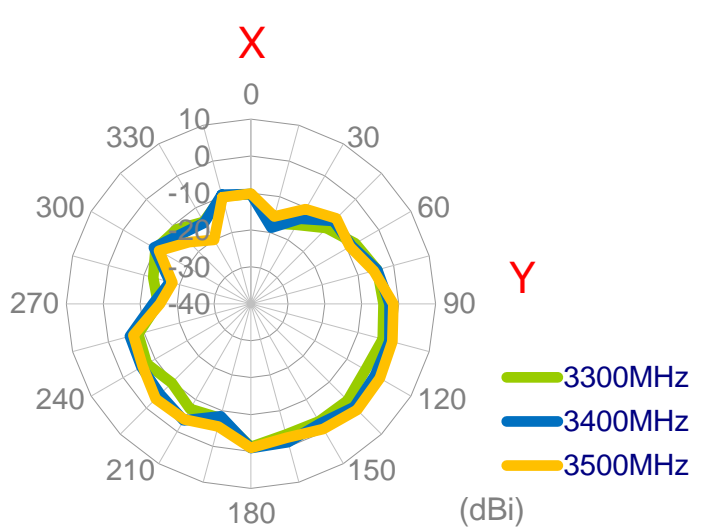
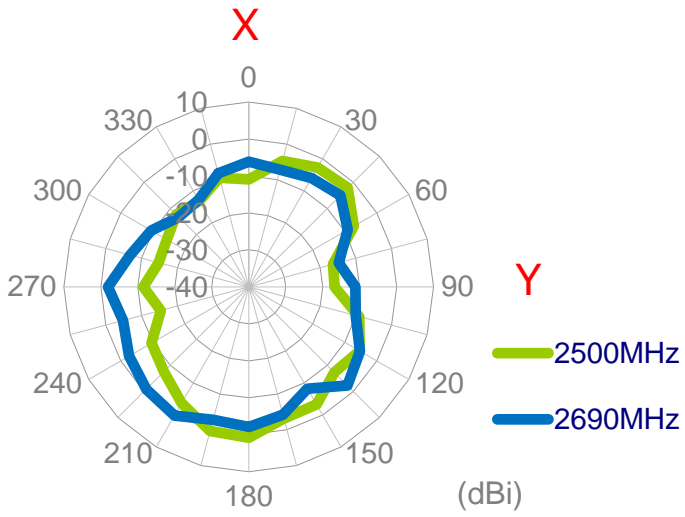
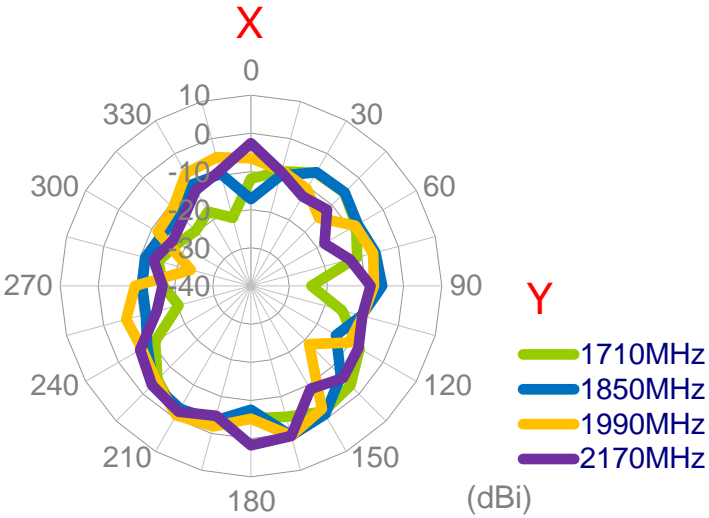
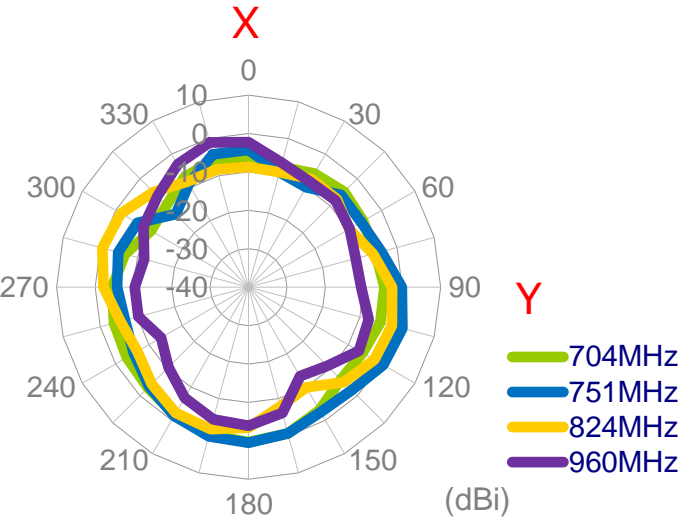

XZ Plane

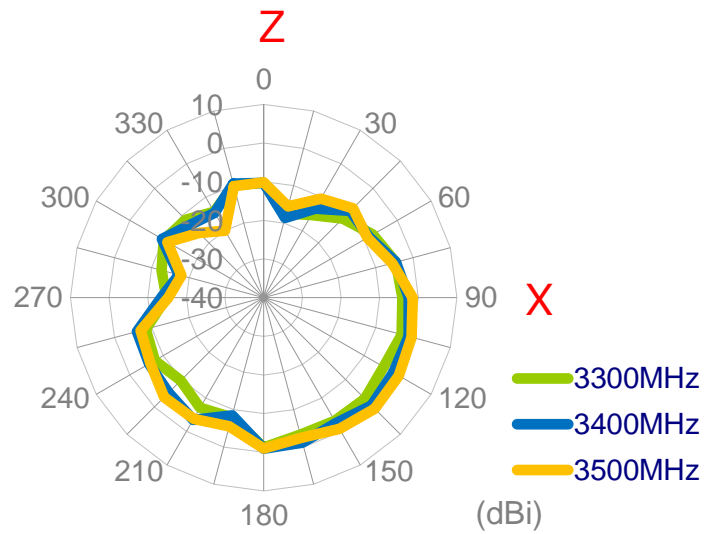
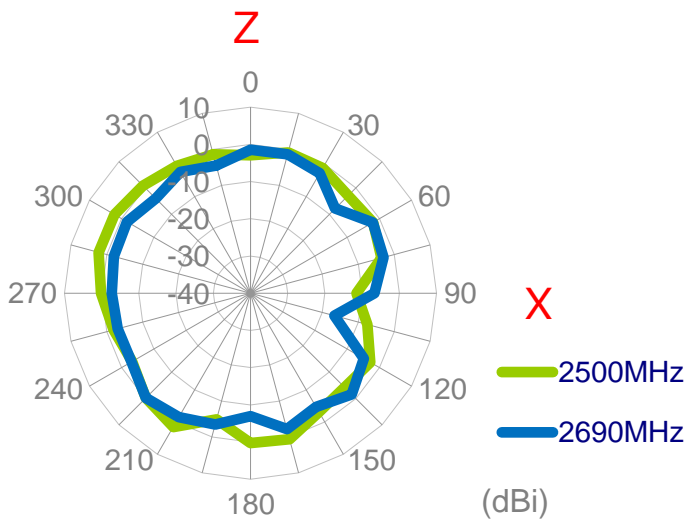
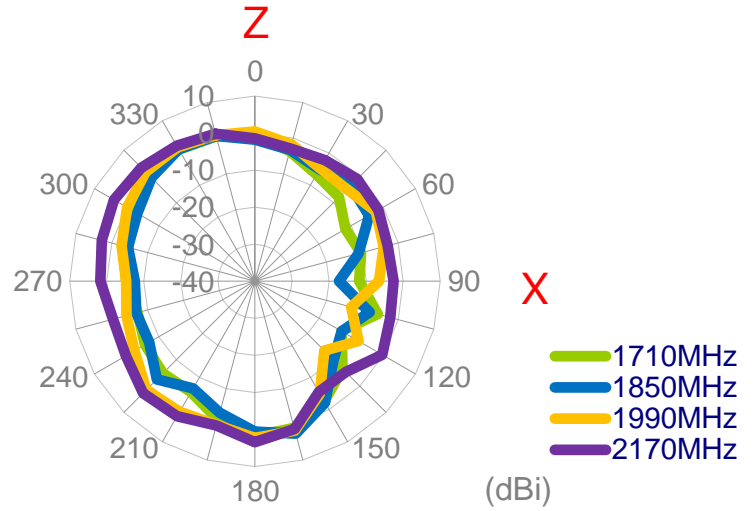
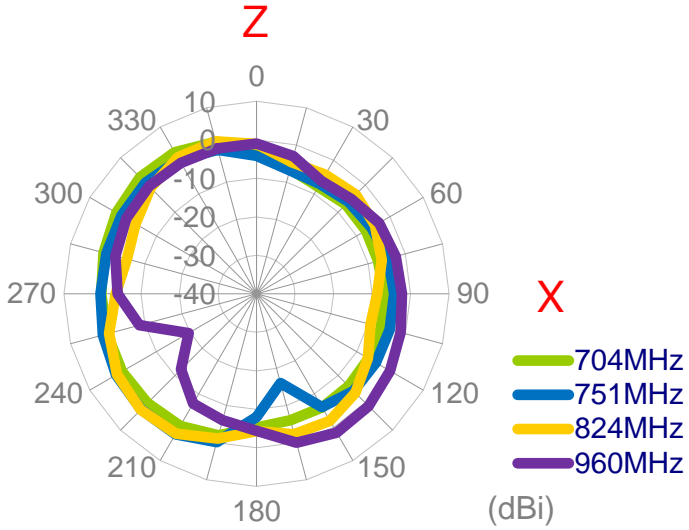

YZ Plane

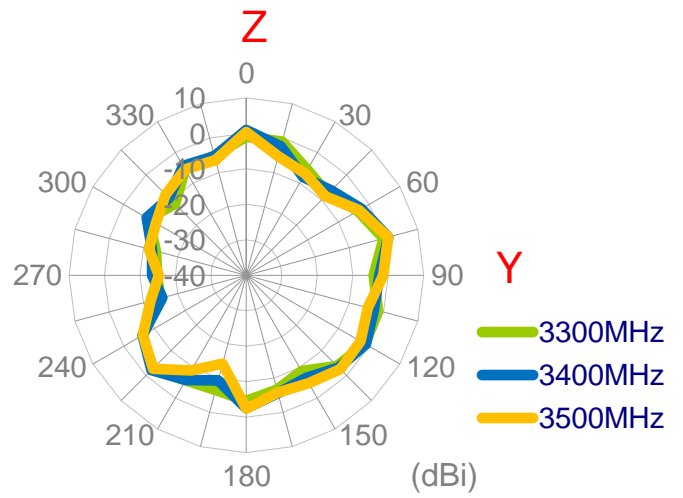
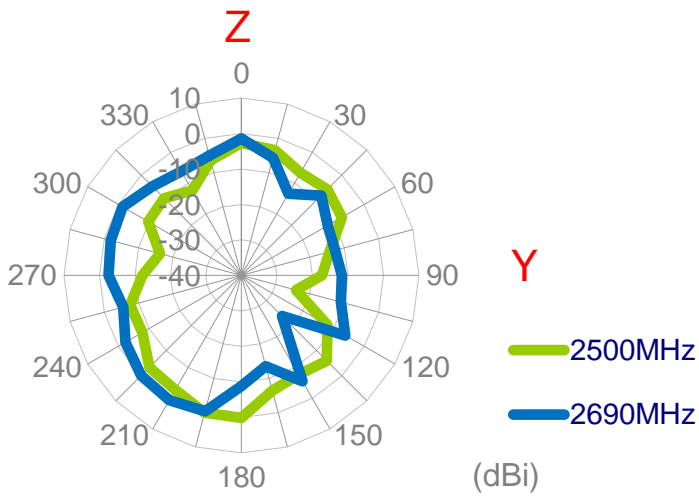
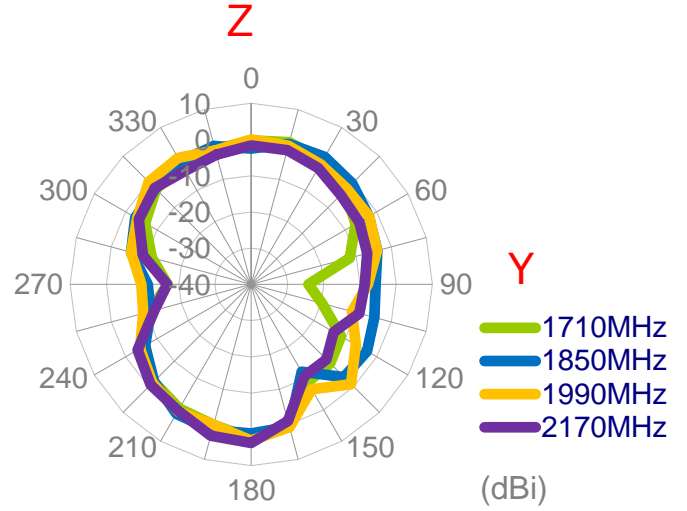
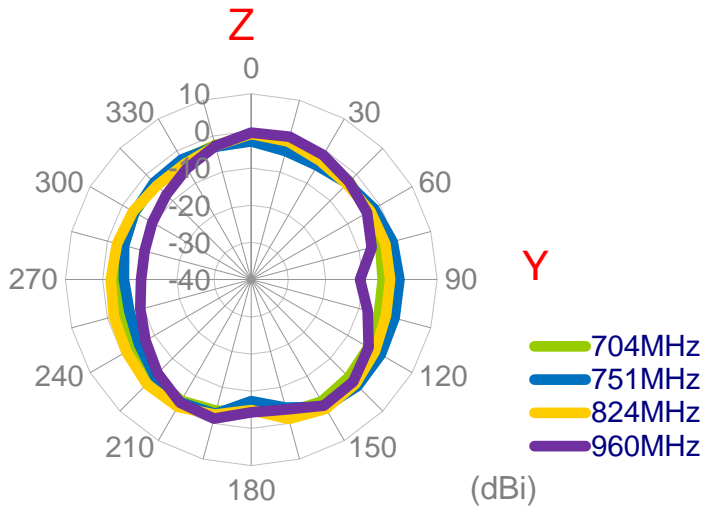

3.1.20 3D Radiation Pattern
 LTE MIMO2 with 3M cable length on the ABS

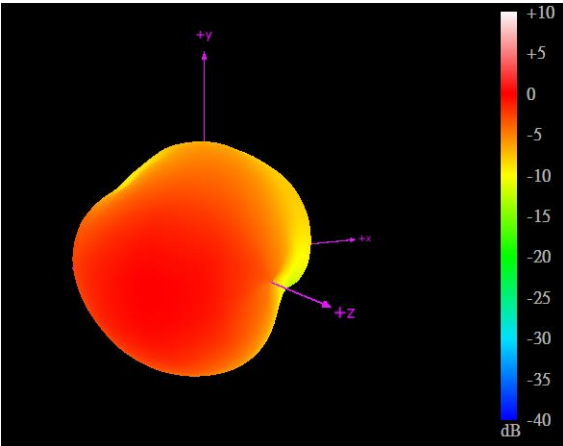

704MHz

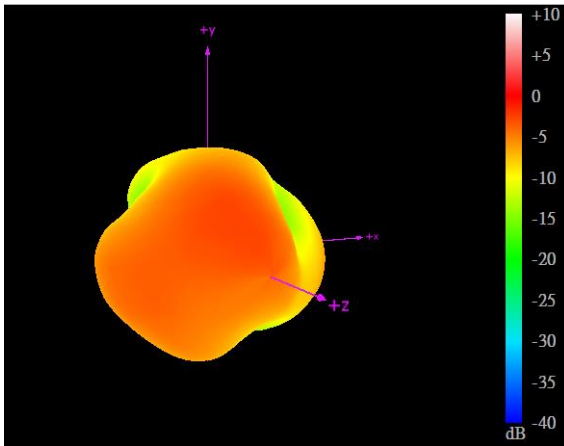

960MHz

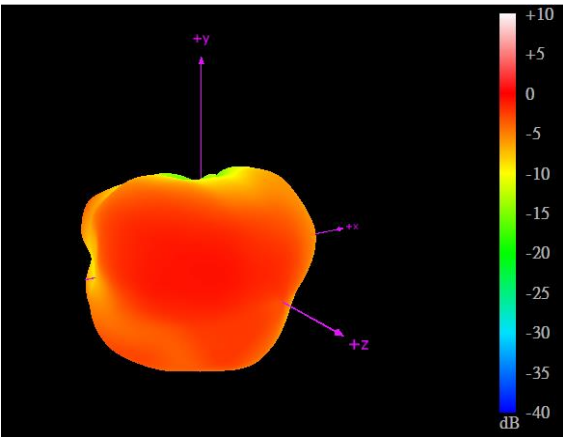

1710MHz

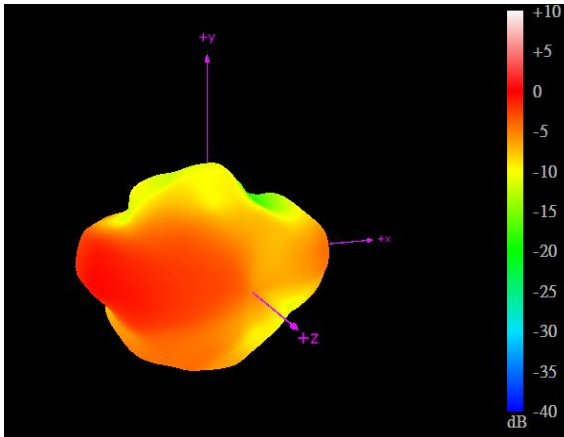

2170MHz

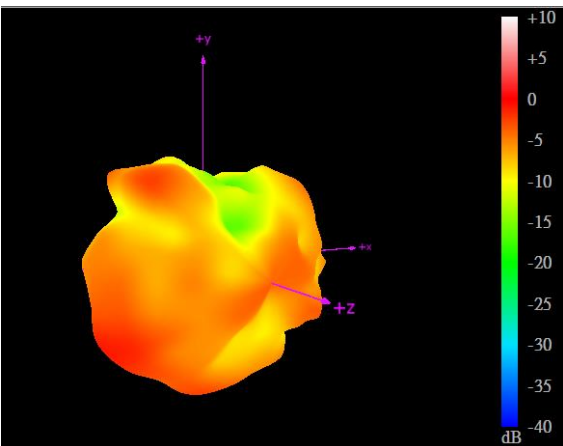

2690MHz

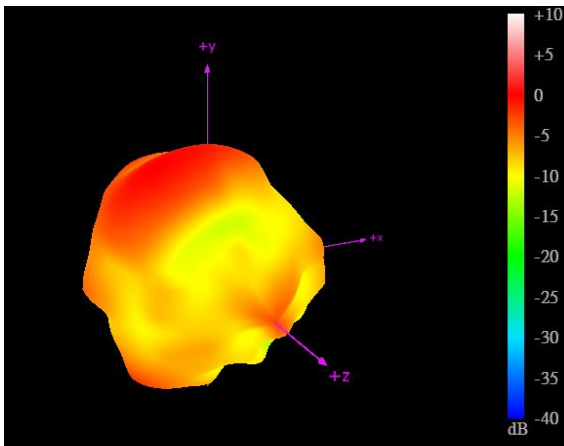

3500MHz

3.1.21 Test Setup For Antenna Radiation Pattern

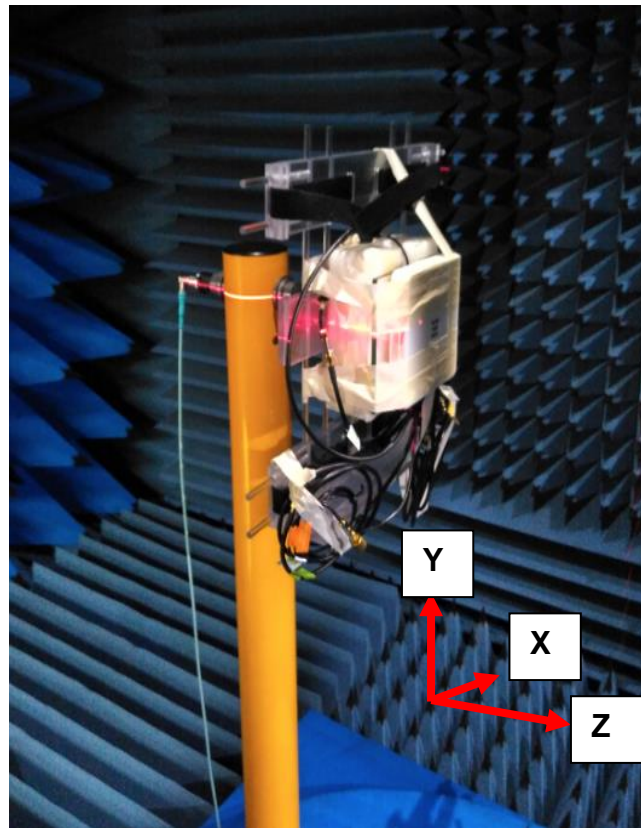

On the glass

3.1.22 2D Radiation Pattern
 LTE MIMO1 with 3M cable length on the glass

XY Plane

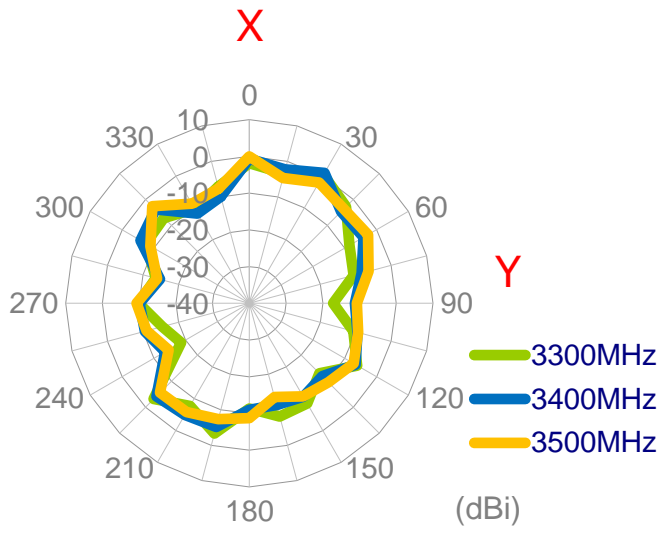
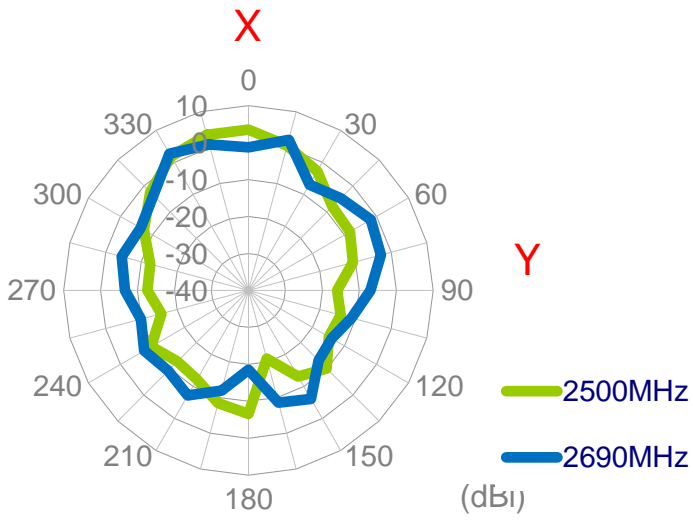
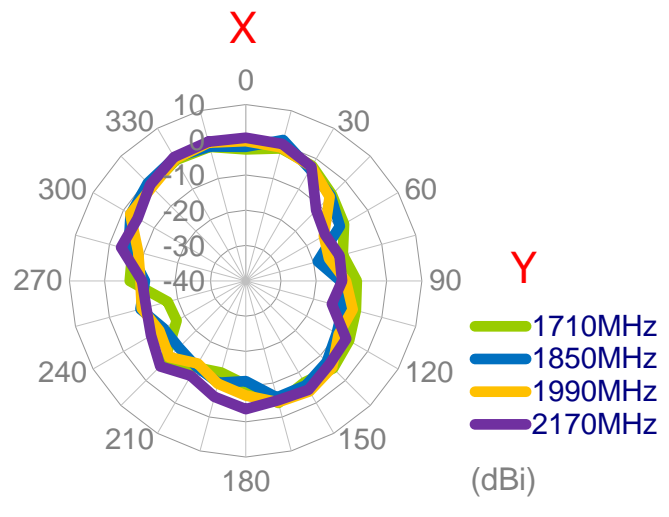
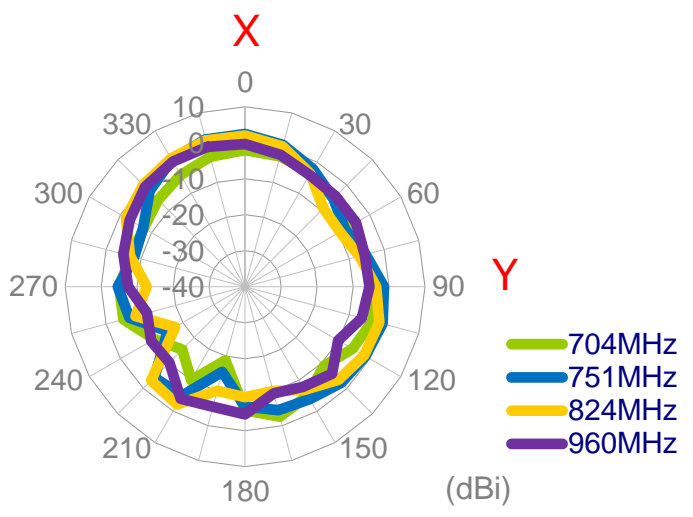

XZ Plane

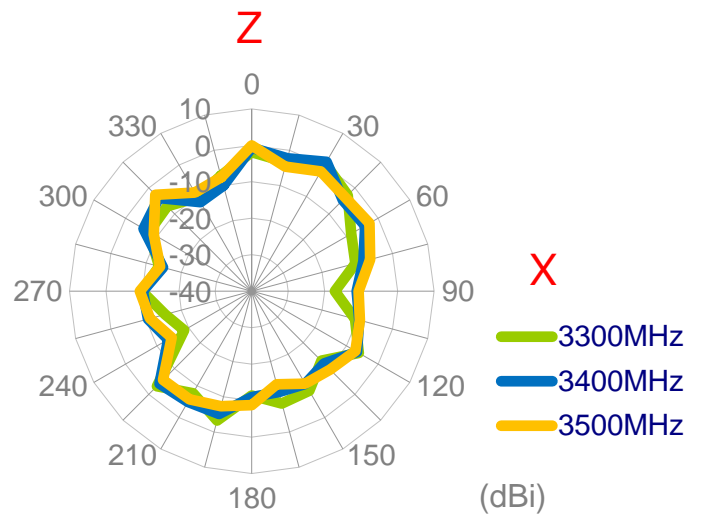
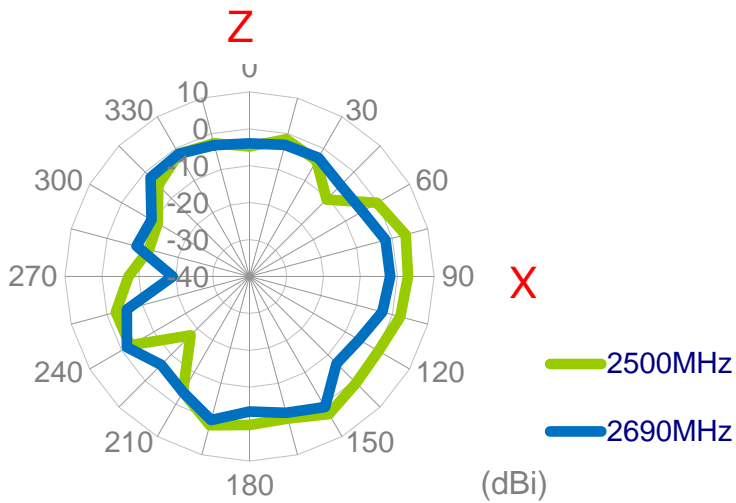
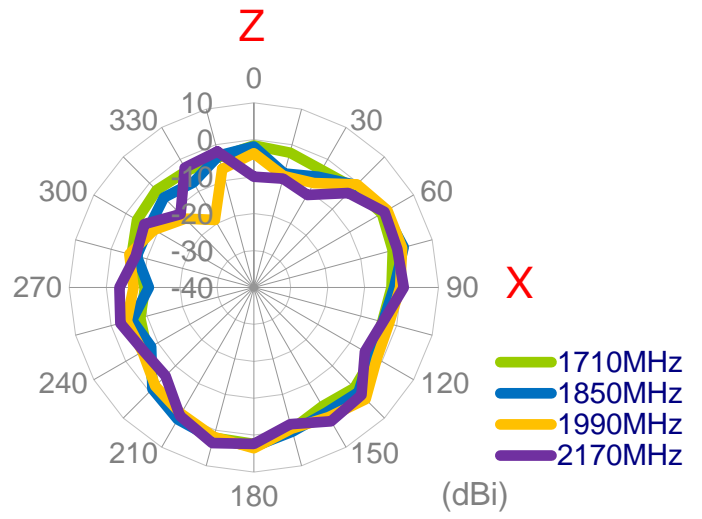
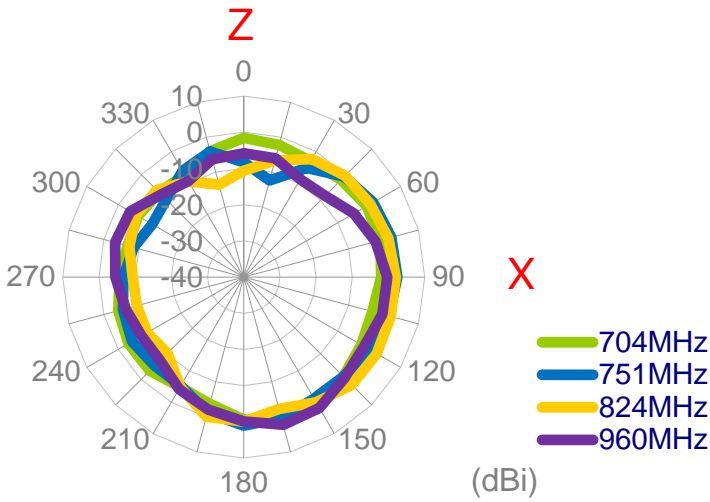

YZ Plane

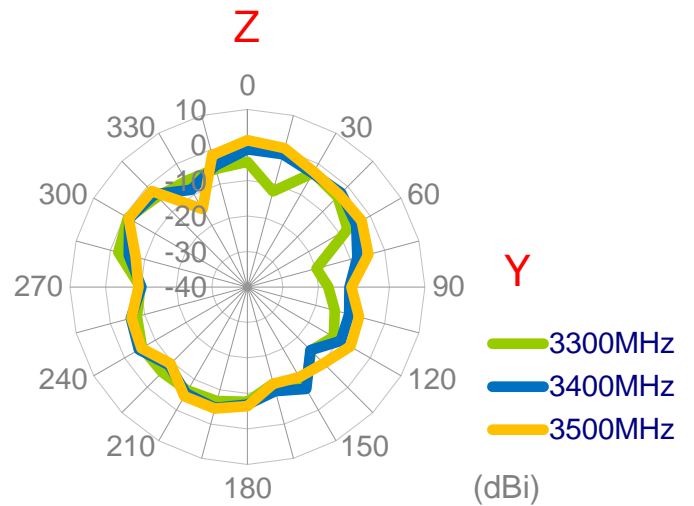
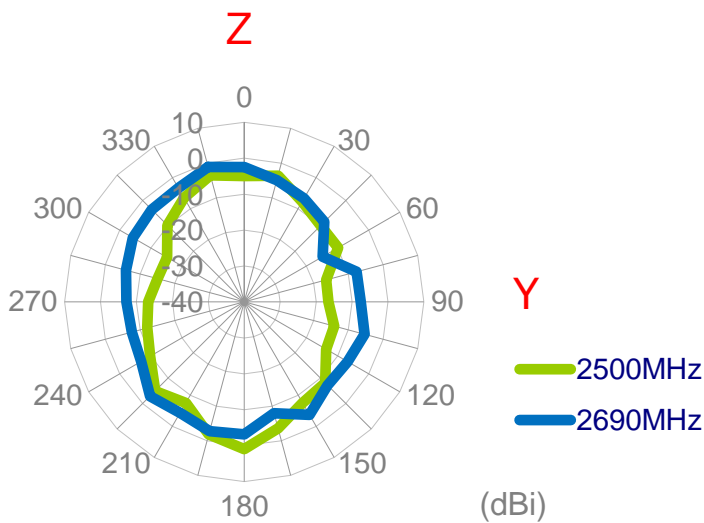
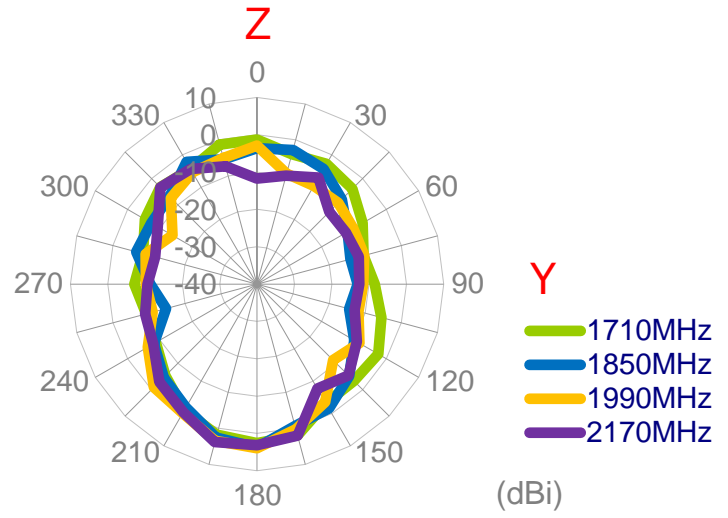
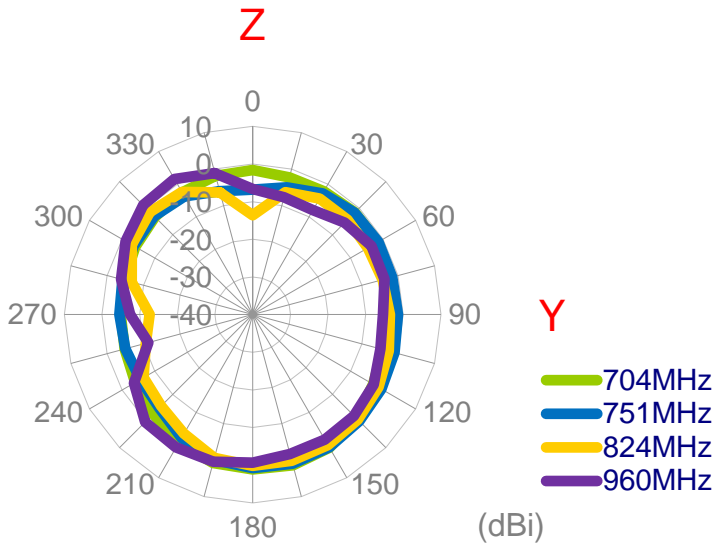

3.1.23 3D Radiation Pattern
LTE MIMO1 with 3M cable length on the glass

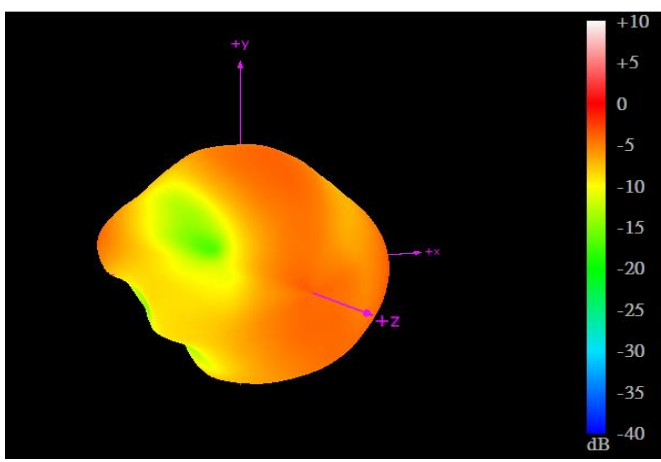

704MHz

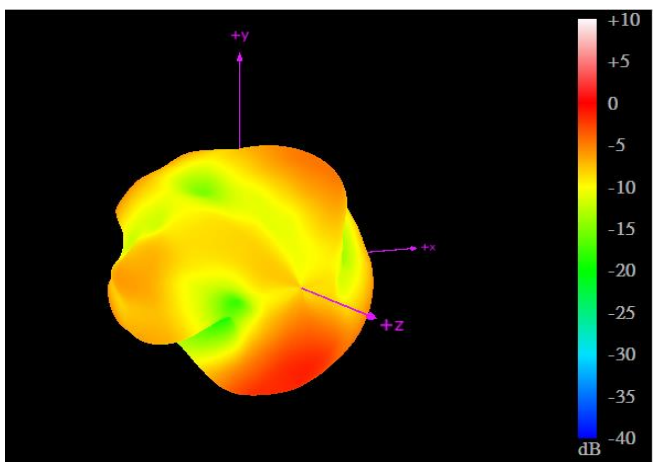

960MHz

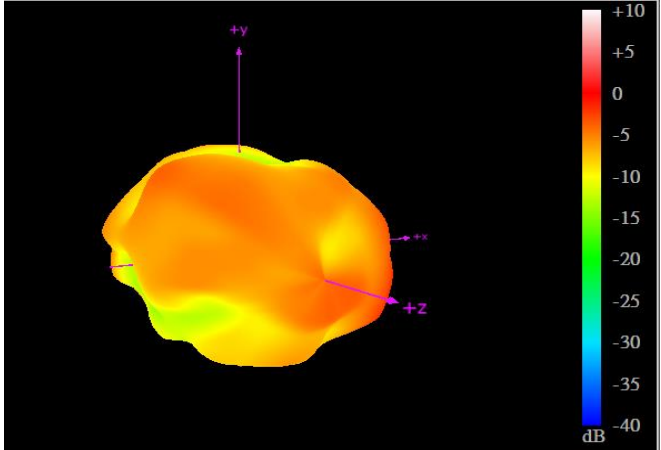

1710MHz

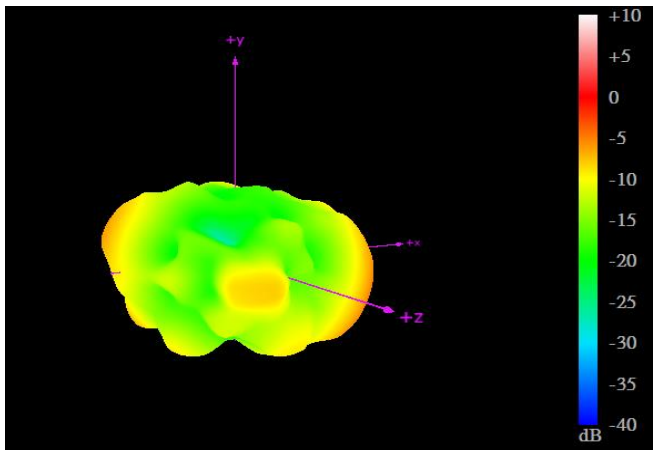

2170MHz

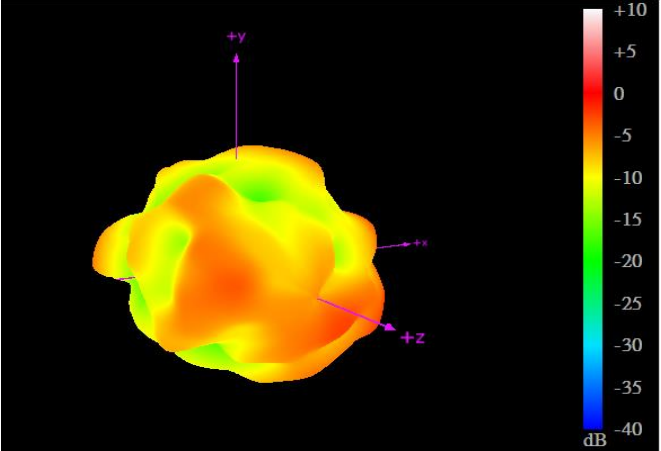

2690MHz

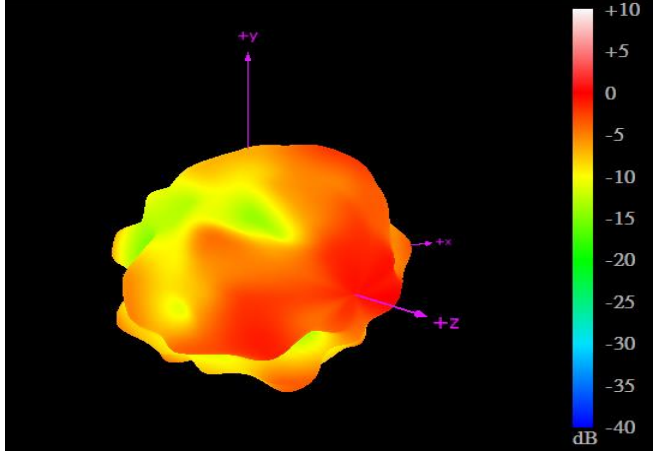

3500MHz

3.1.24 2D Radiation Pattern
 LTE MIMO2 with 3M cable length on the glass

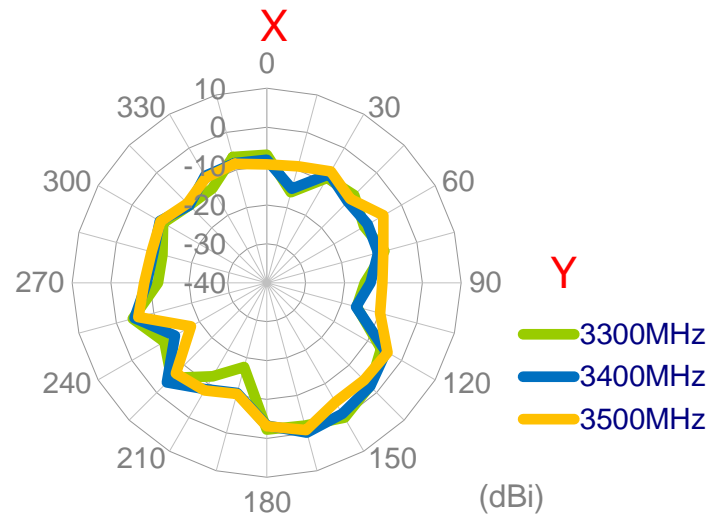
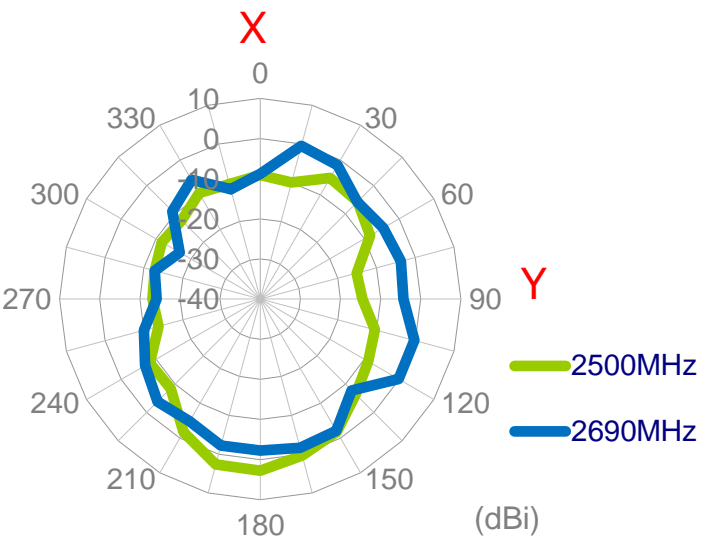
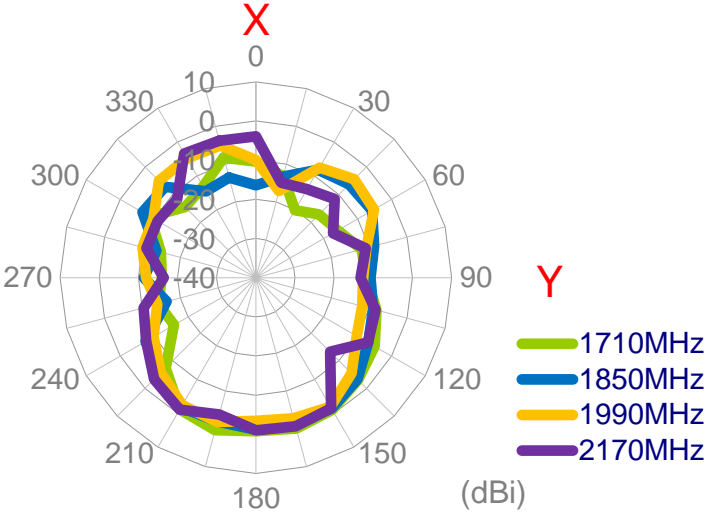
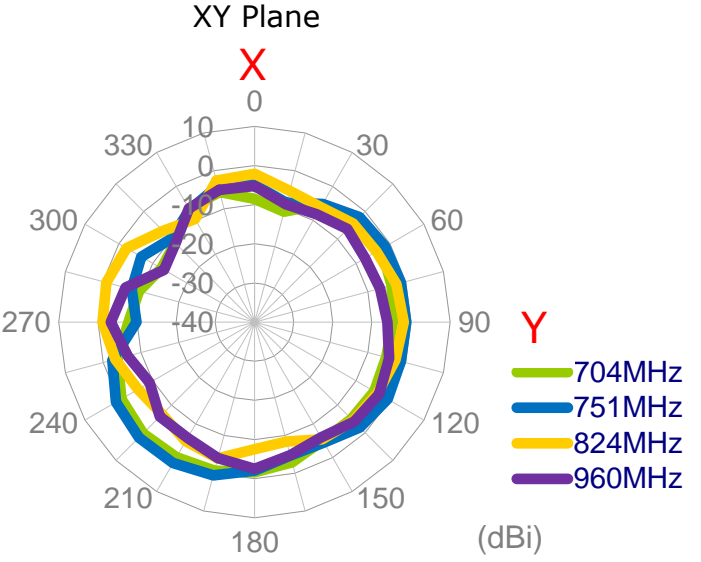

XZ Plane

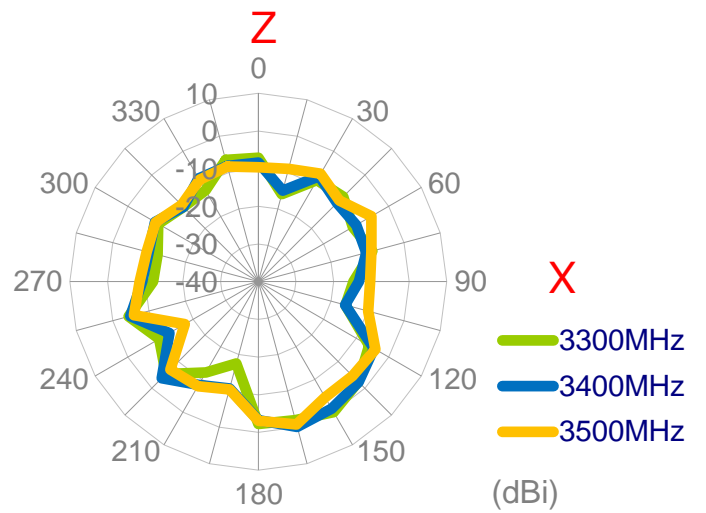
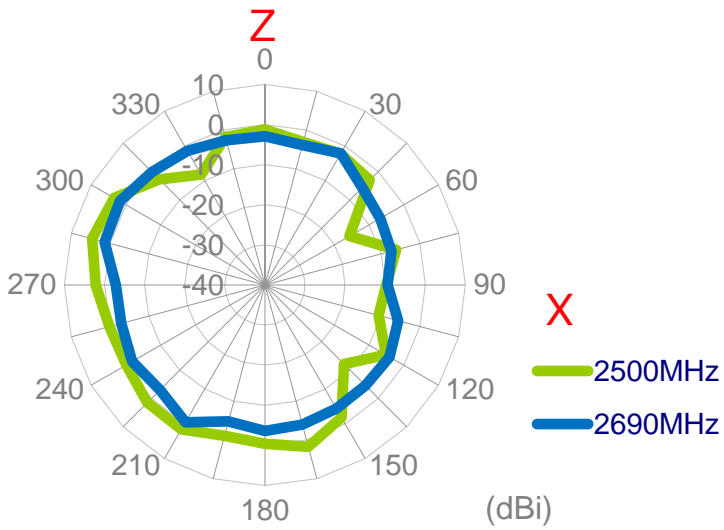
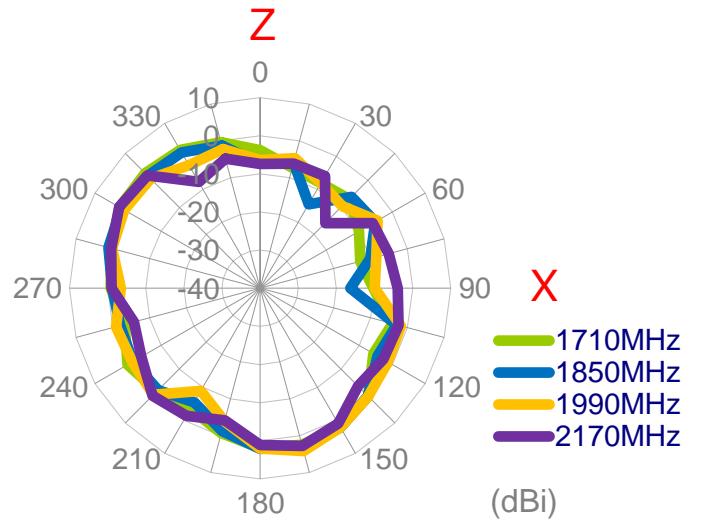
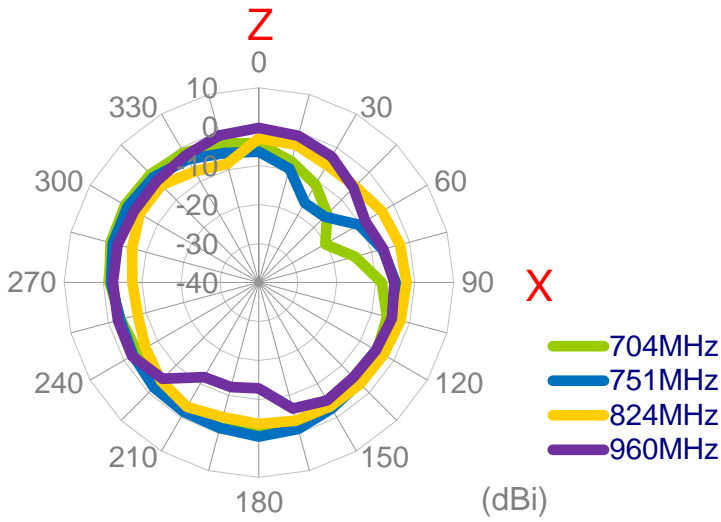

YZ Plane

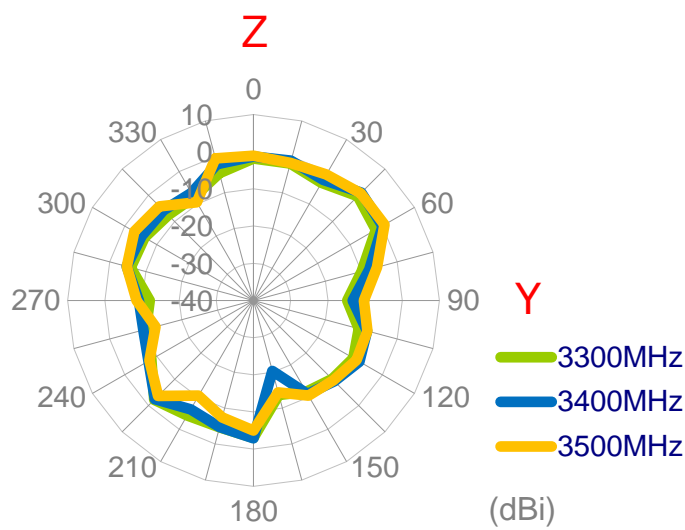
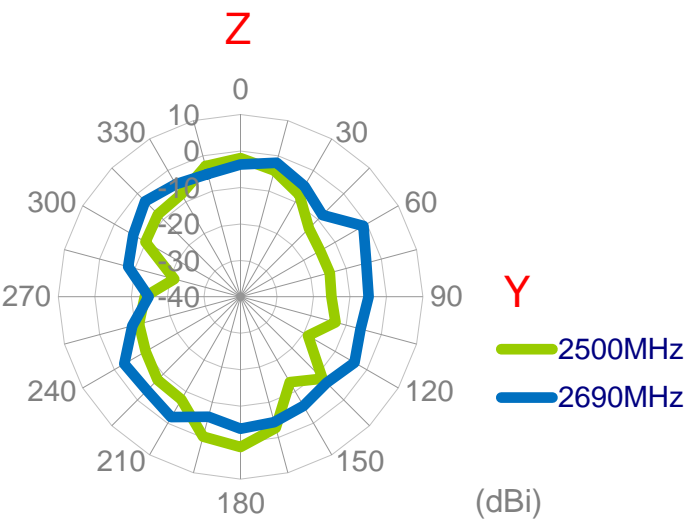
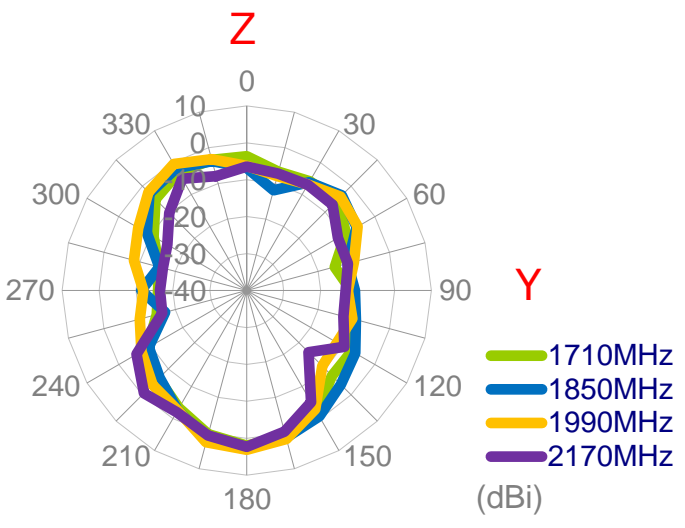
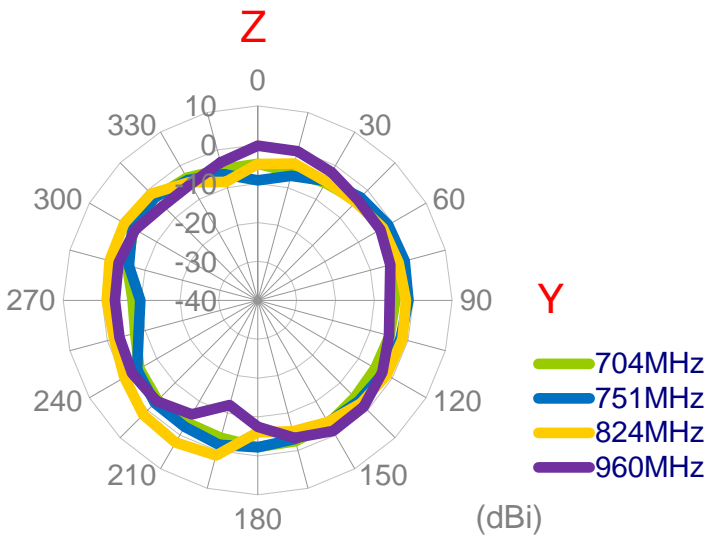

3.1.25 3D Radiation Pattern
LTE MIMO2 with 3M cable length on the glass

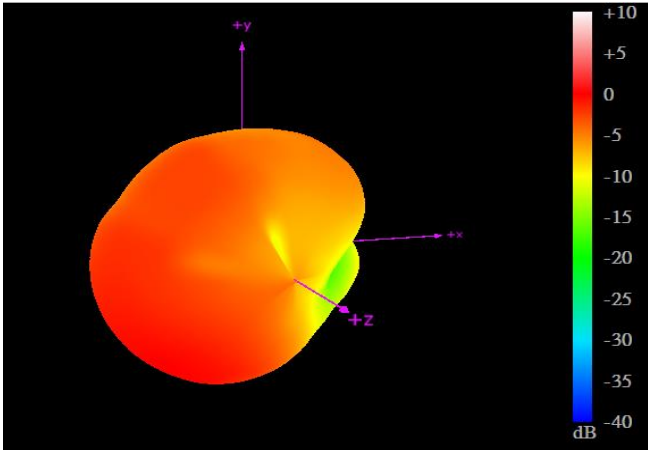

704MHz

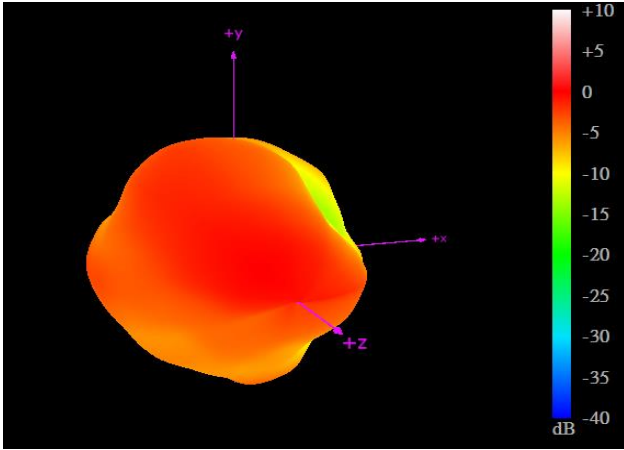

960MHz

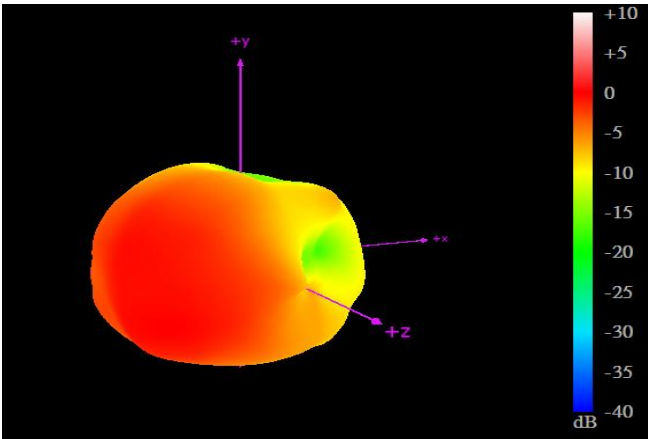

1710MHz

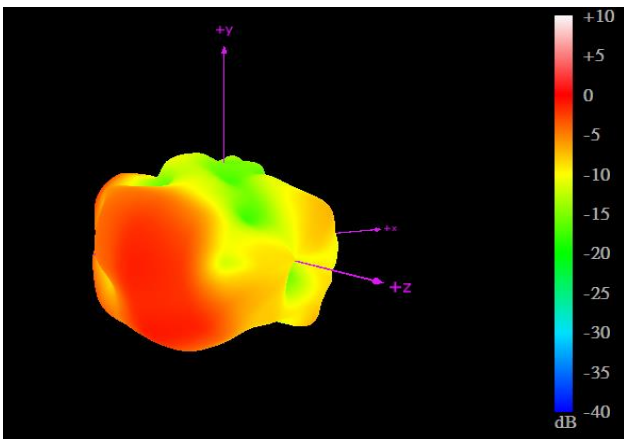

2170MHz

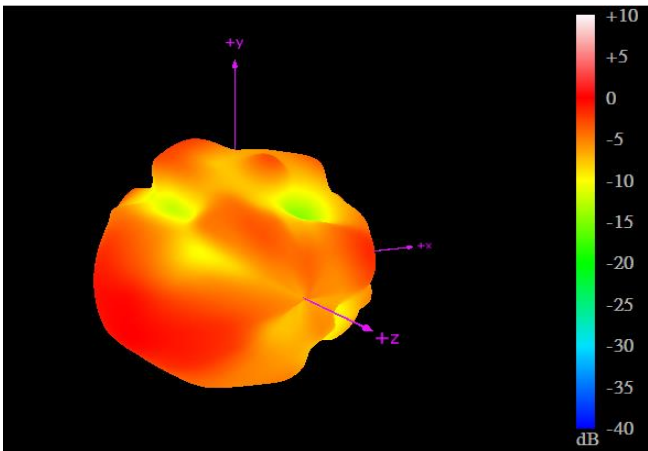

2690MHz

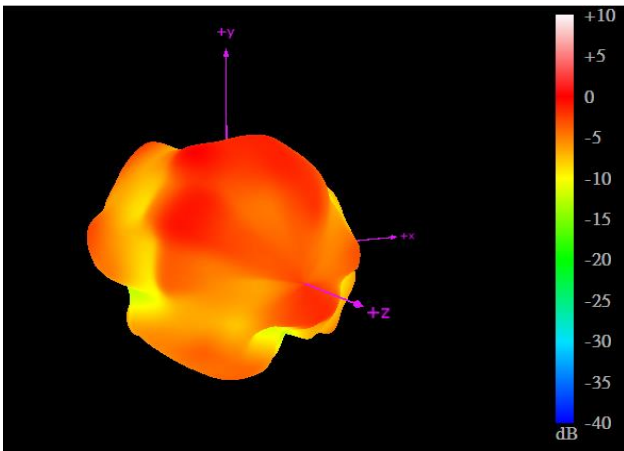

3500MHz

3.1.26 Test Setup For Antenna Radiation Pattern

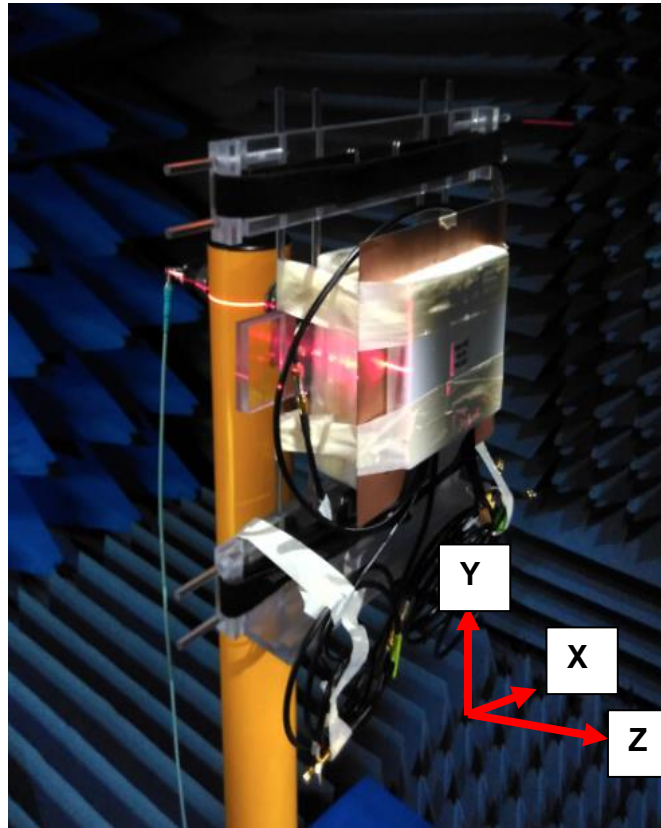

On the metal

3.1.27 2D Radiation Pattern
 LTE MIMO1 with 3M cable length on the metal

XY Plane

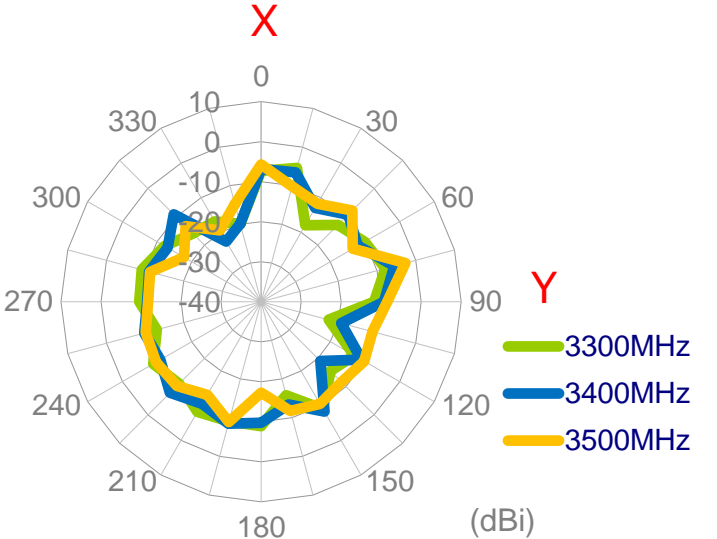
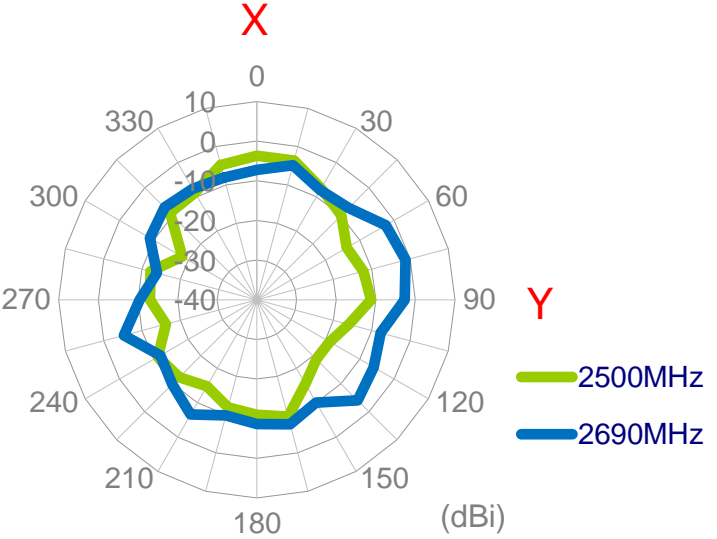
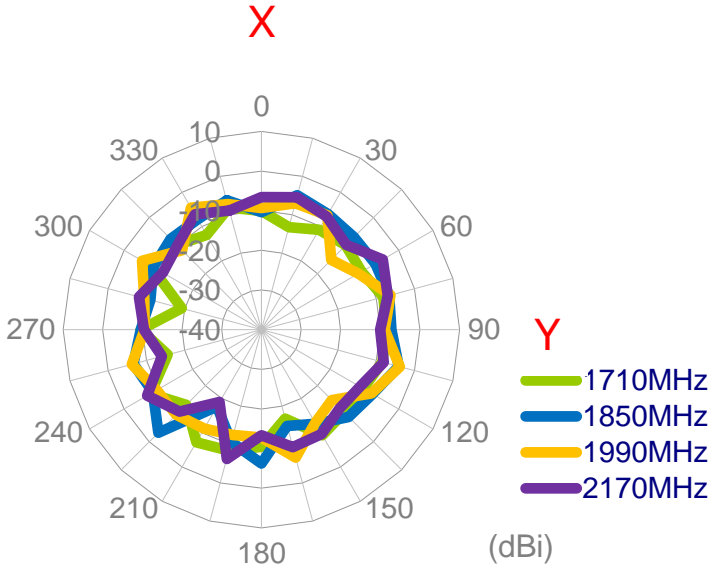
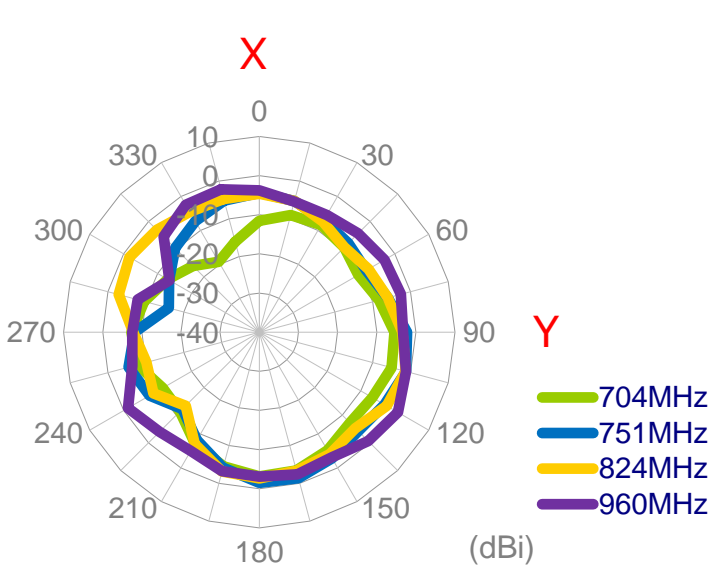

XZ Plane

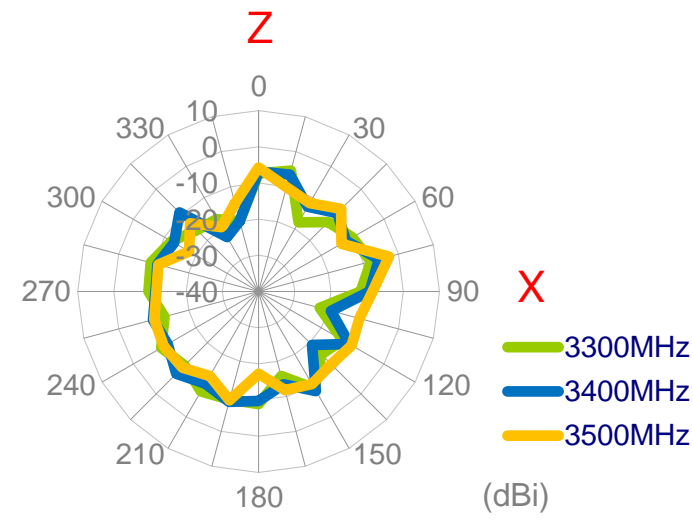
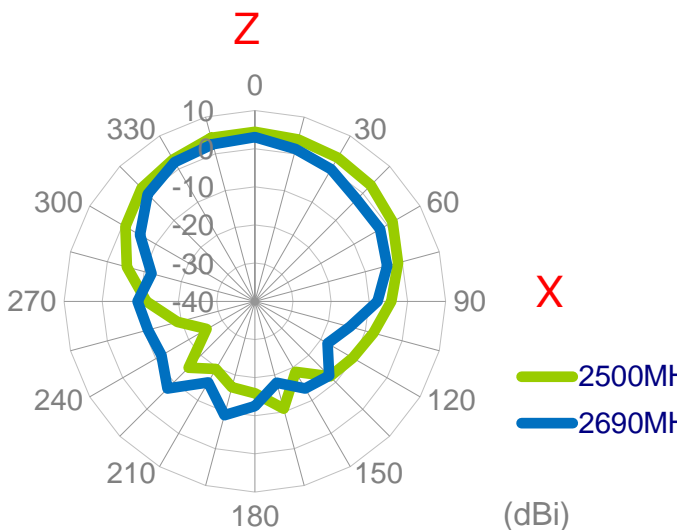
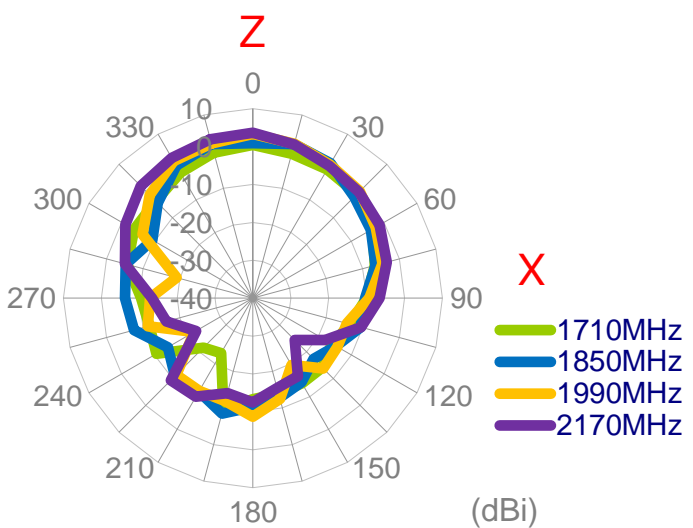
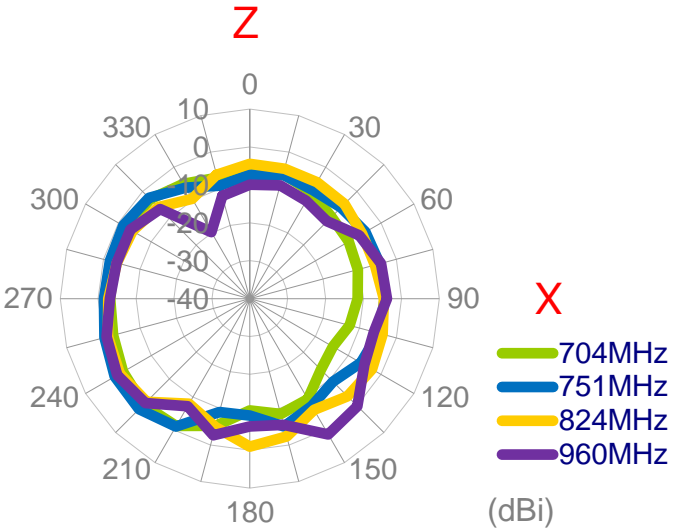

YZ Plane

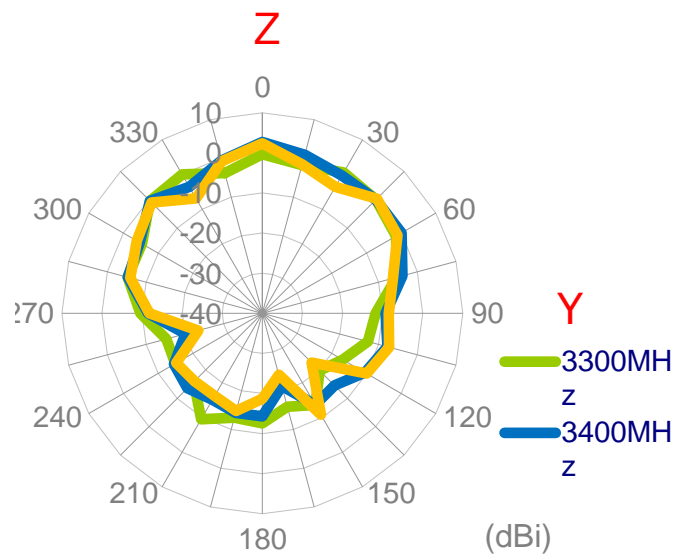
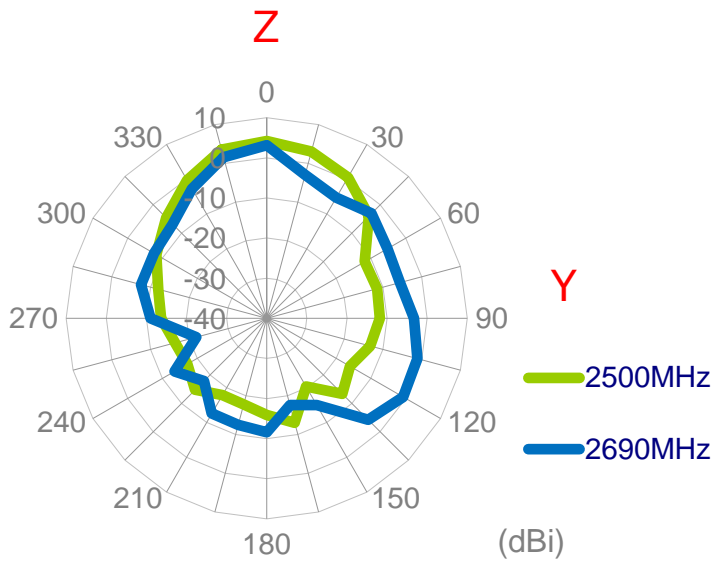
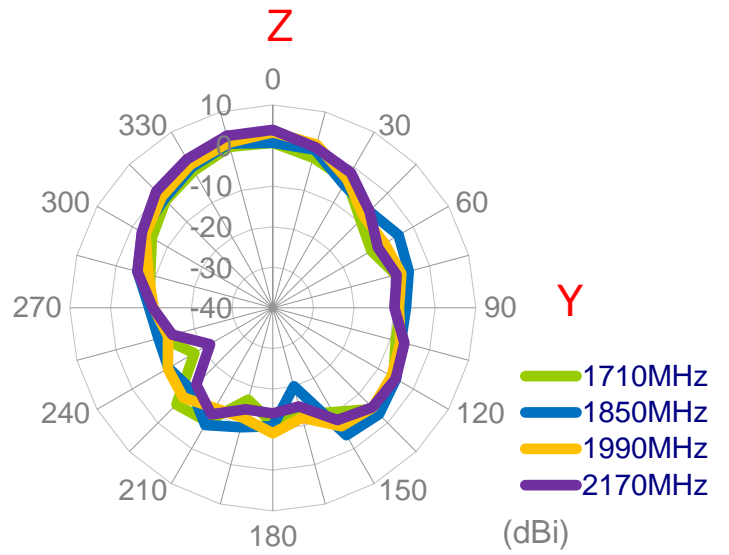
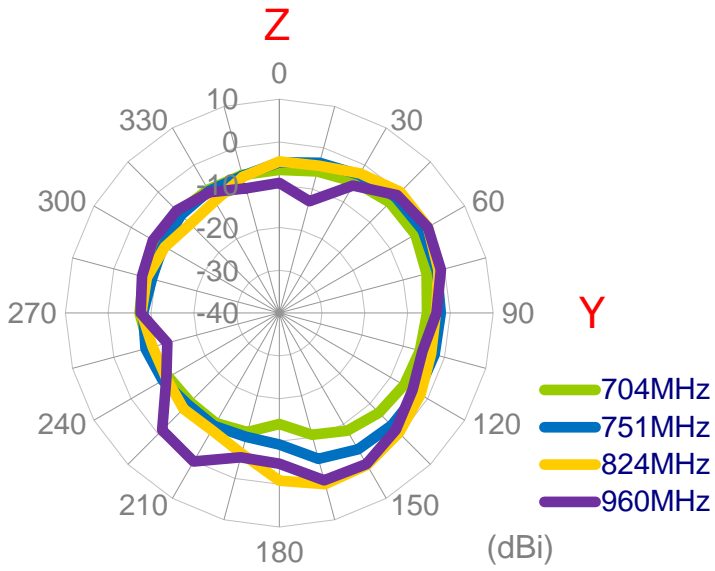

3.1.28 3D Radiation Pattern
LTE MIMO1 with 3M cable length on the metal

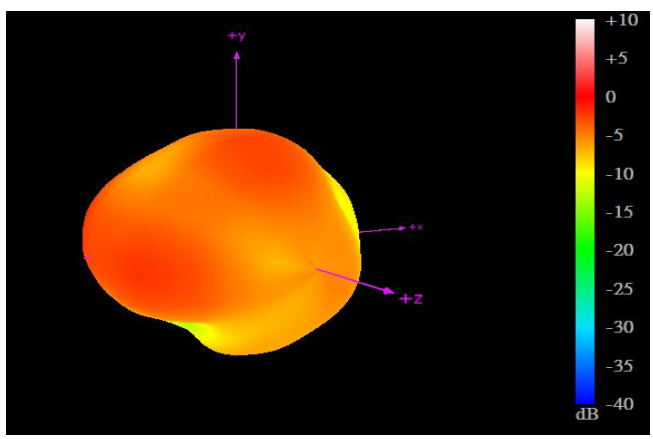

704MHz

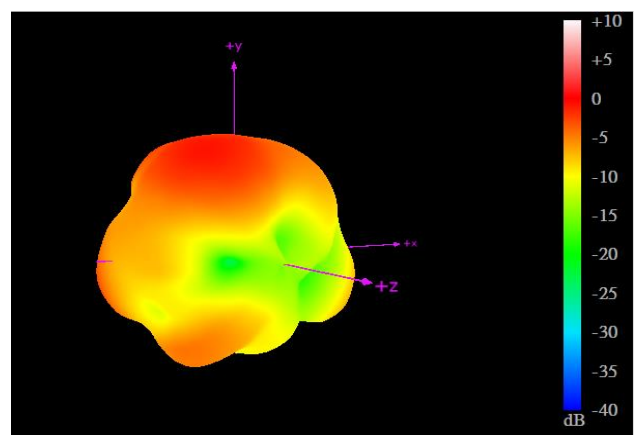

960MHz

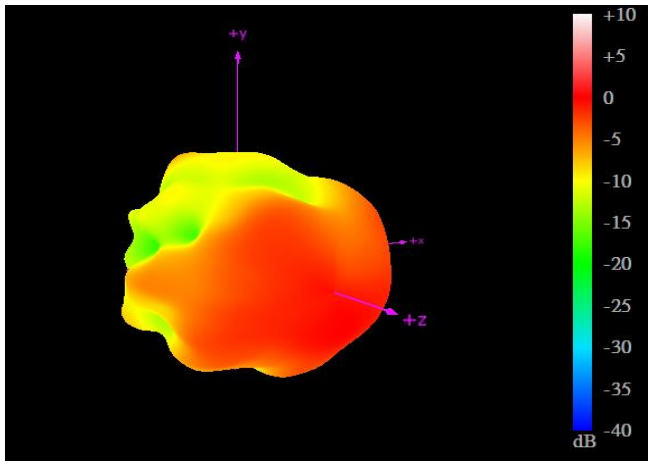

1710MHz

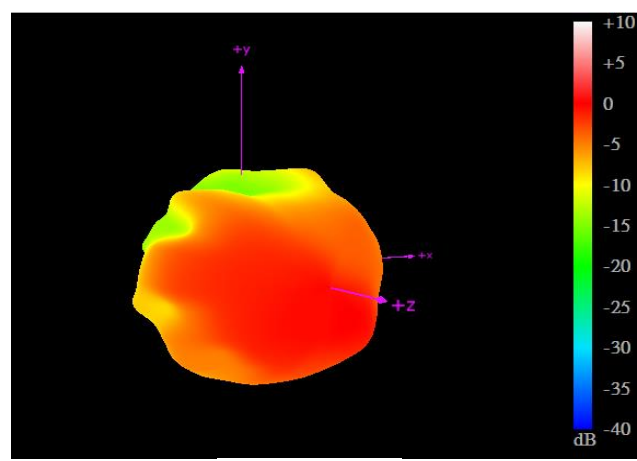

2170MHz

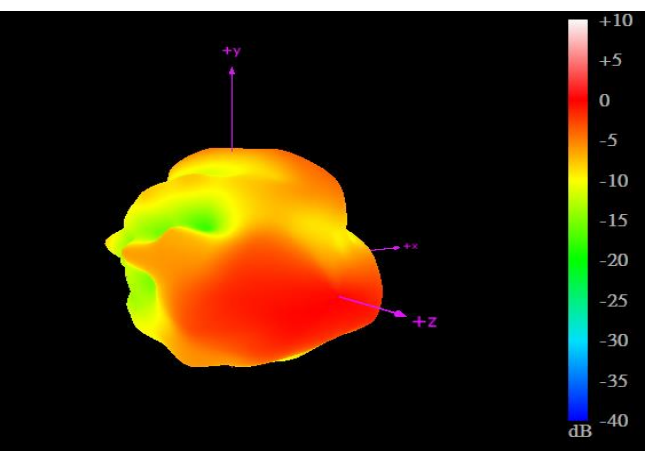

2690MHz

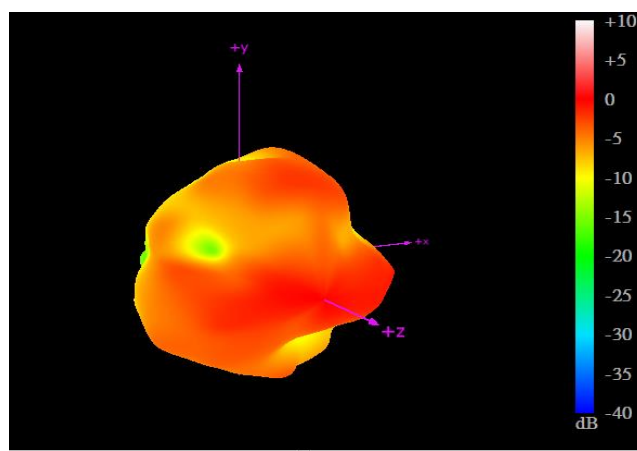

3500MHz

3.1.29 2D Radiation Pattern
 LTE MIMO2 with 3M cable length on the metal

XY Plane

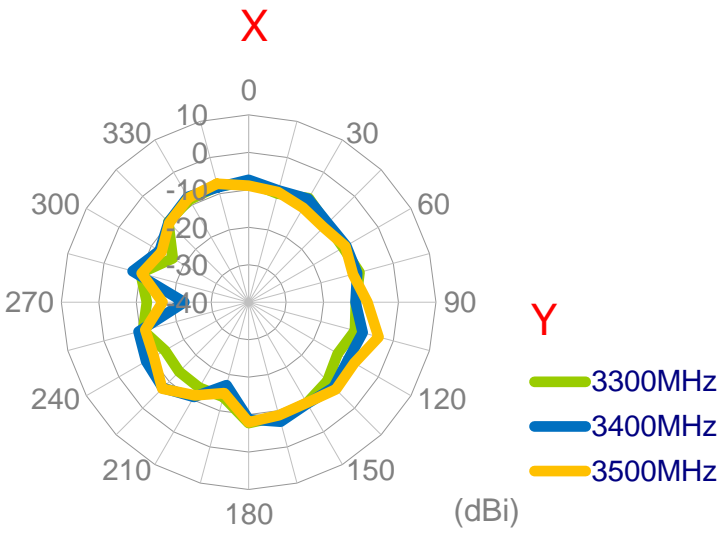
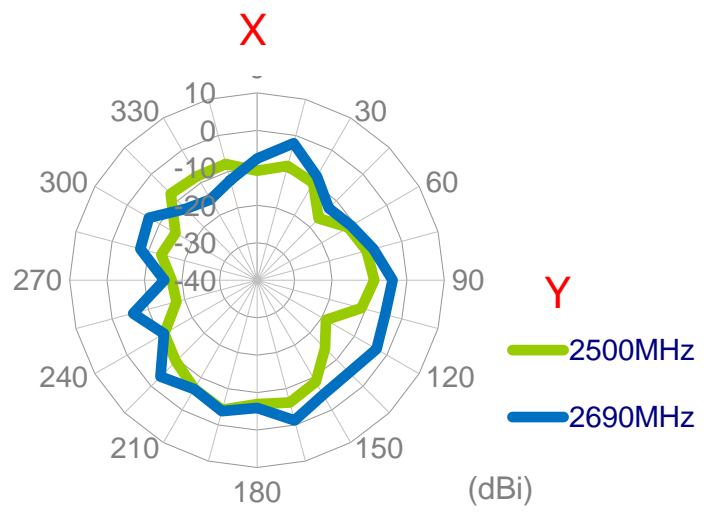
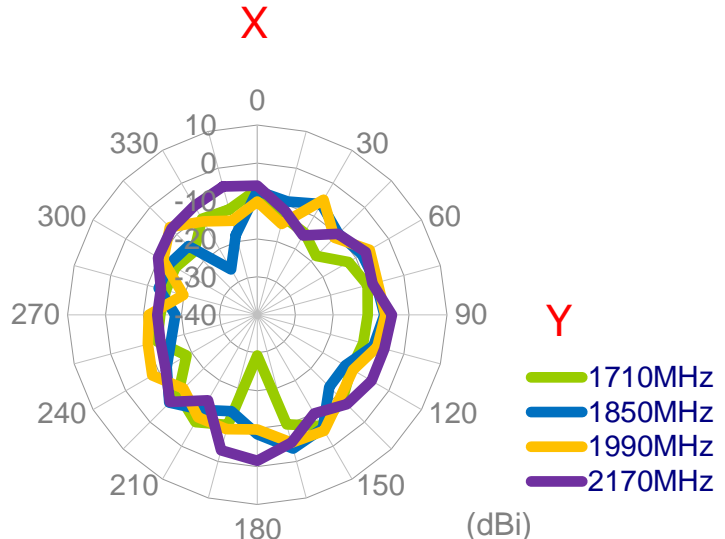
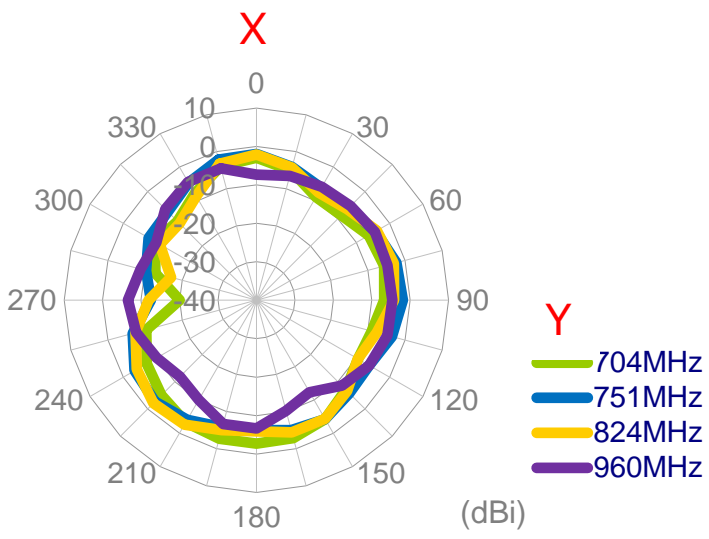

XZ Plane

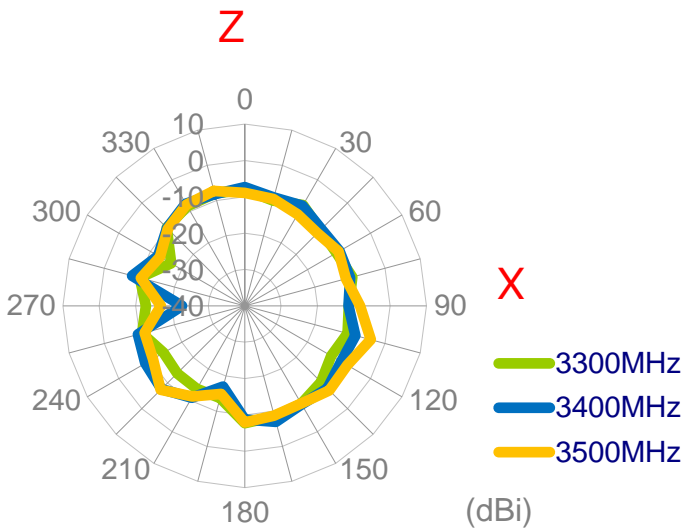
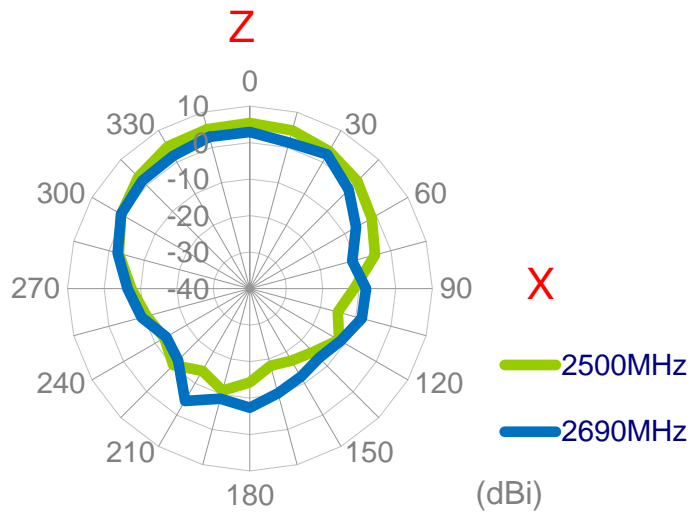
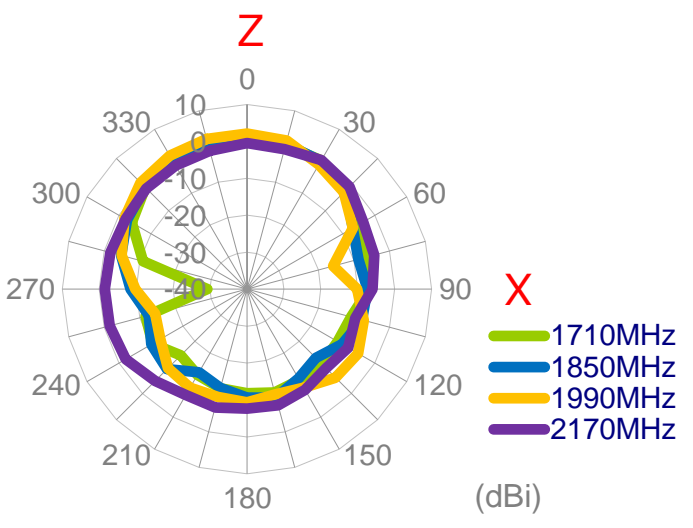
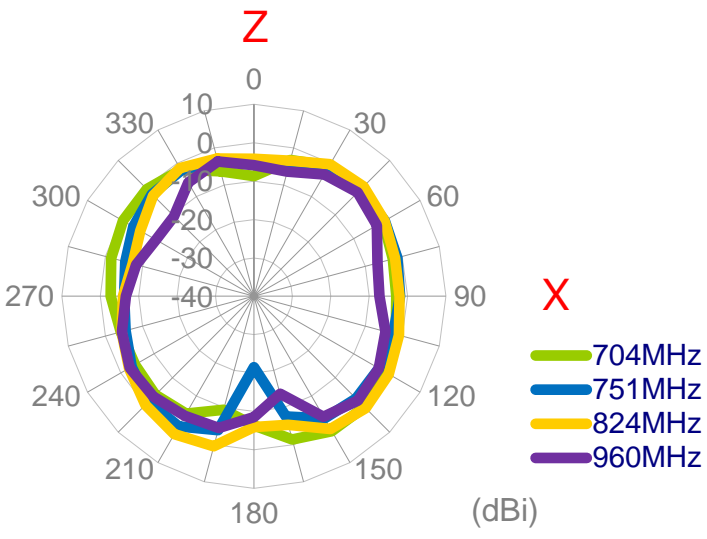

YZ Plane

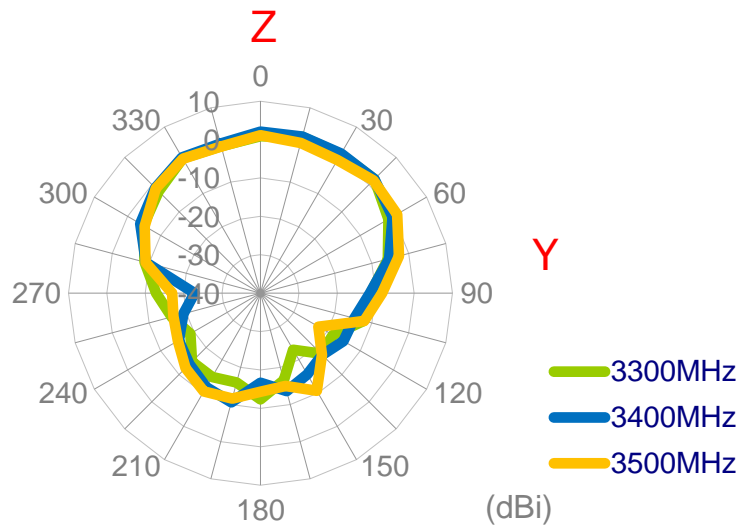
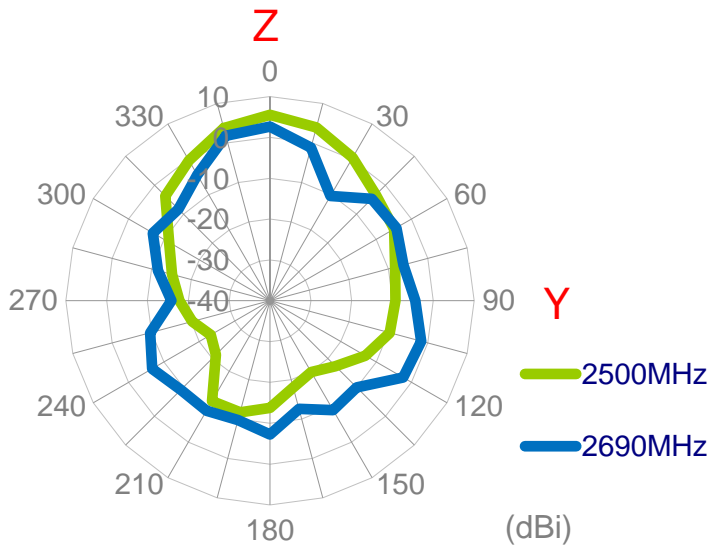
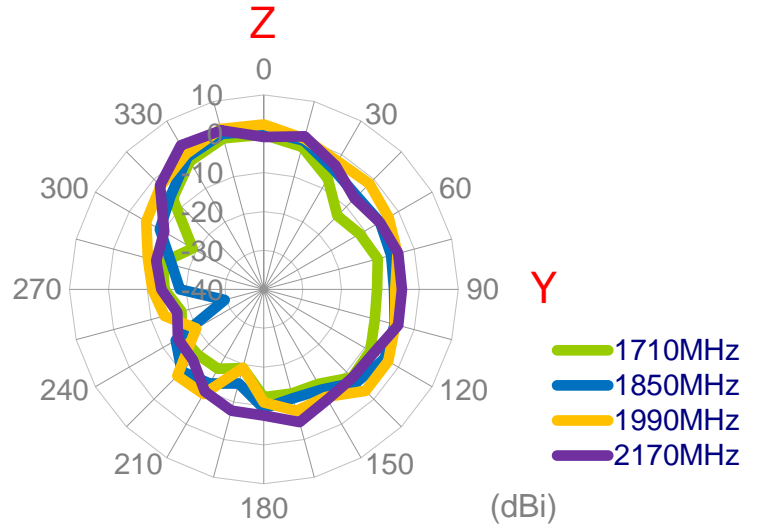
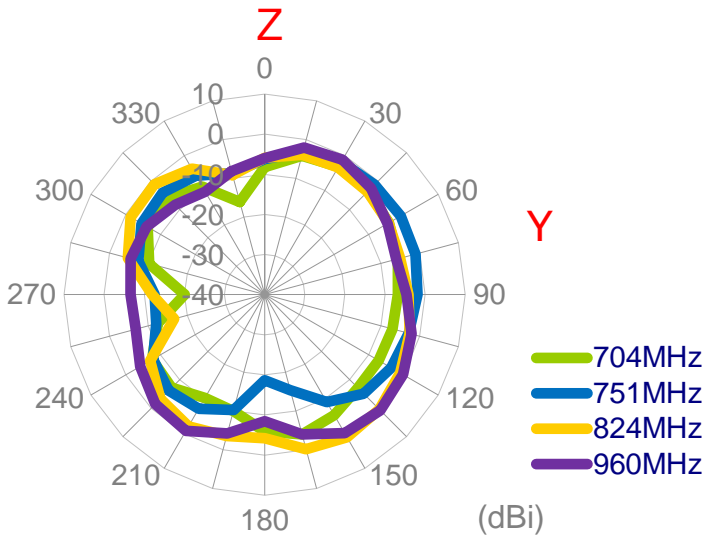

3.1.30 3D Radiation Pattern
 LTE MIMO2 with 3M cable length on the metal

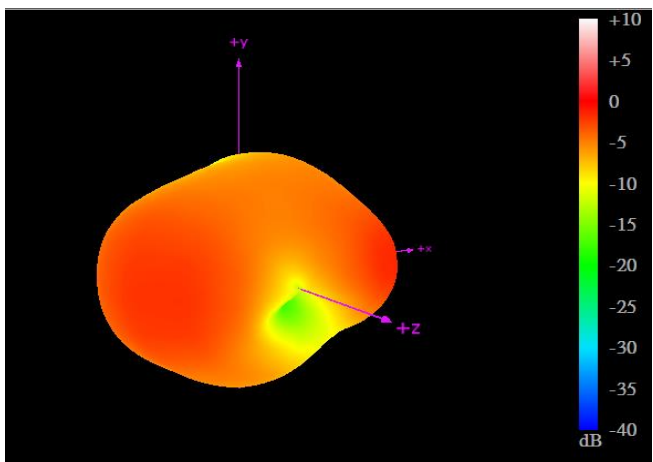

704MHz

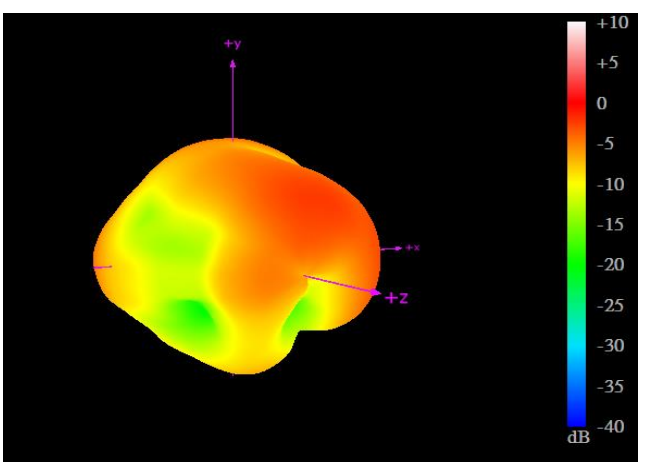

960MHz

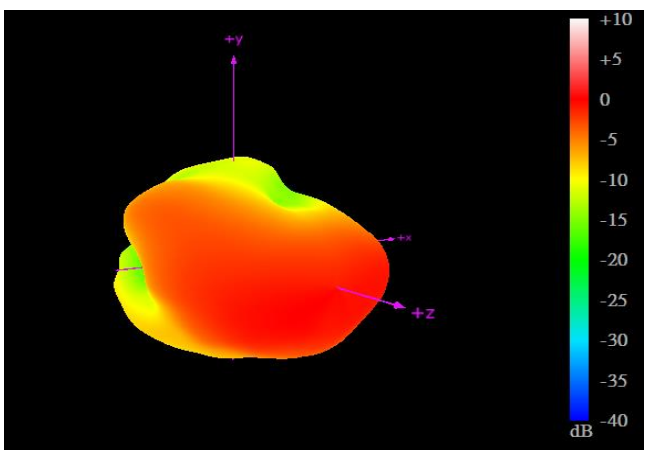

1710MHz

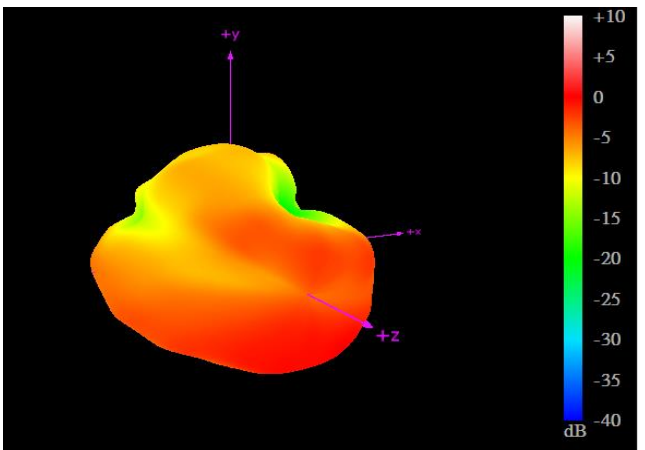

2170MHz

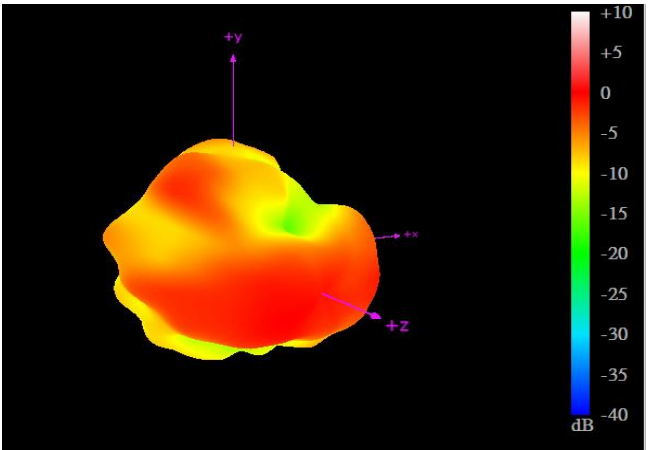

2690MHz

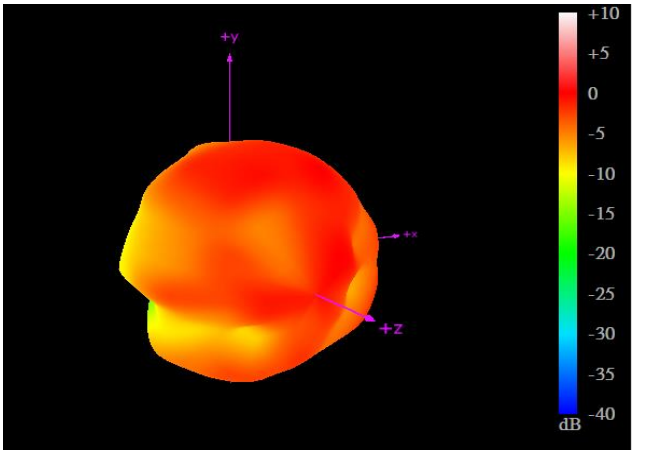

3500MHz

3.1.31 Test Setup For Antenna Radiation Pattern

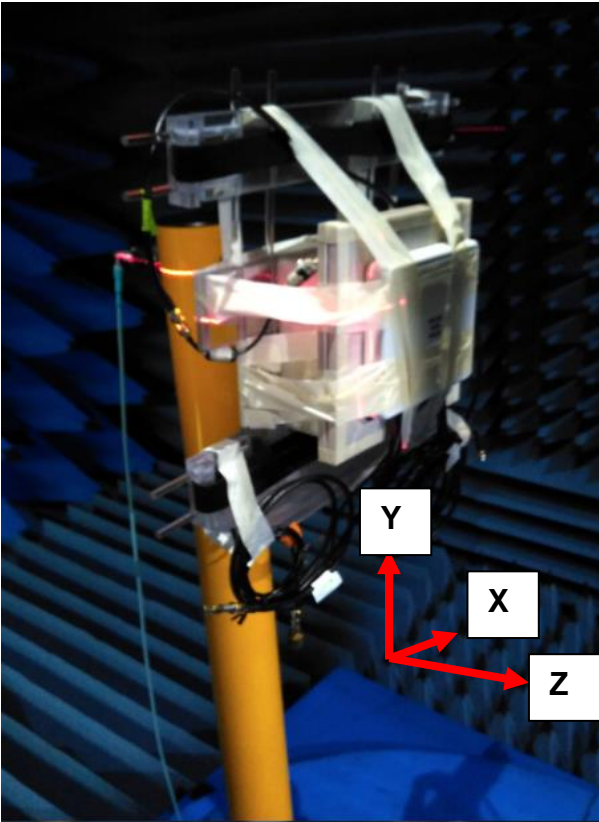

On the Wall

3.1.32 2D Radiation Pattern
 LTE MIMO1 with 3M cable length on the wall

XY Plane

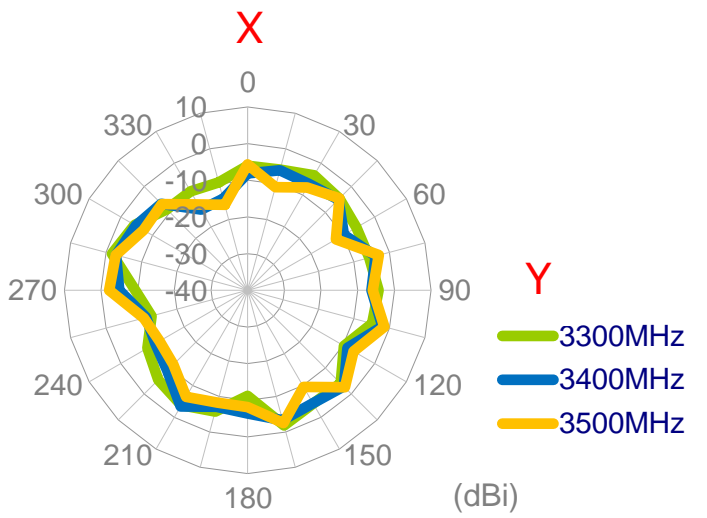
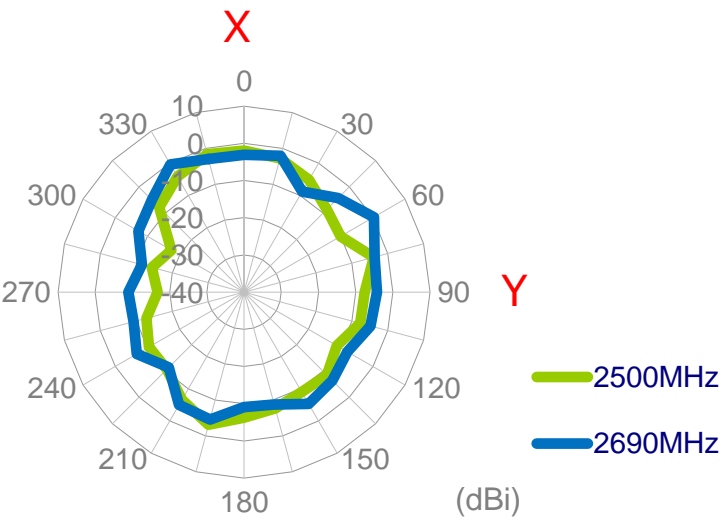
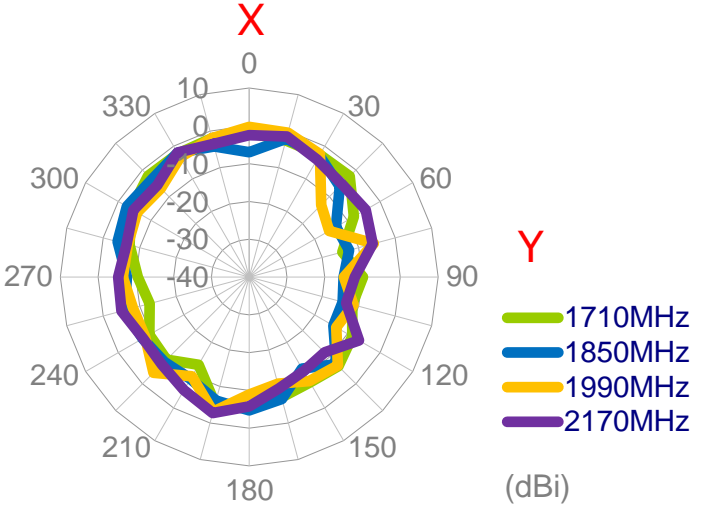
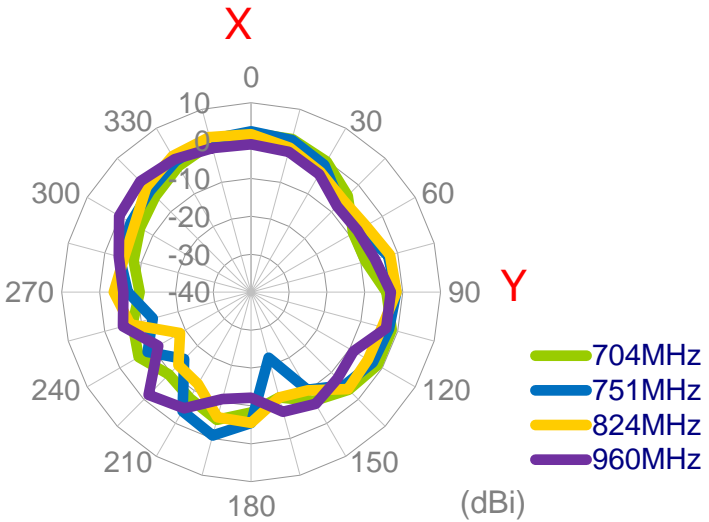

XZ Plane

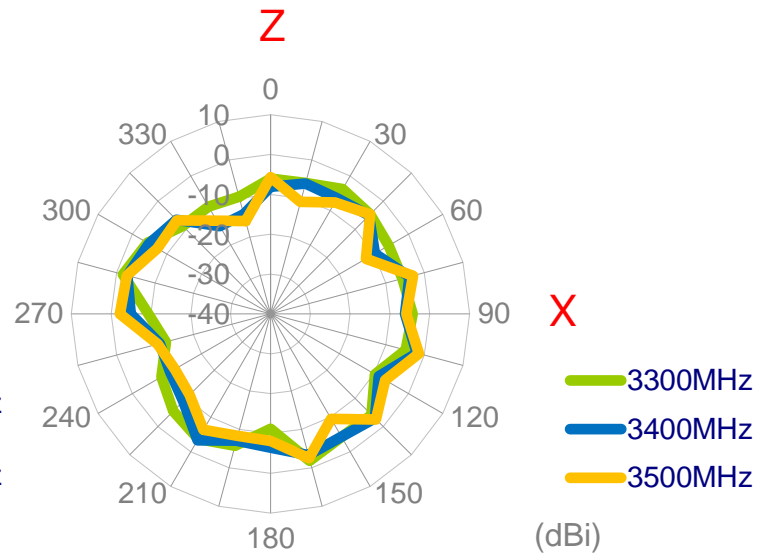
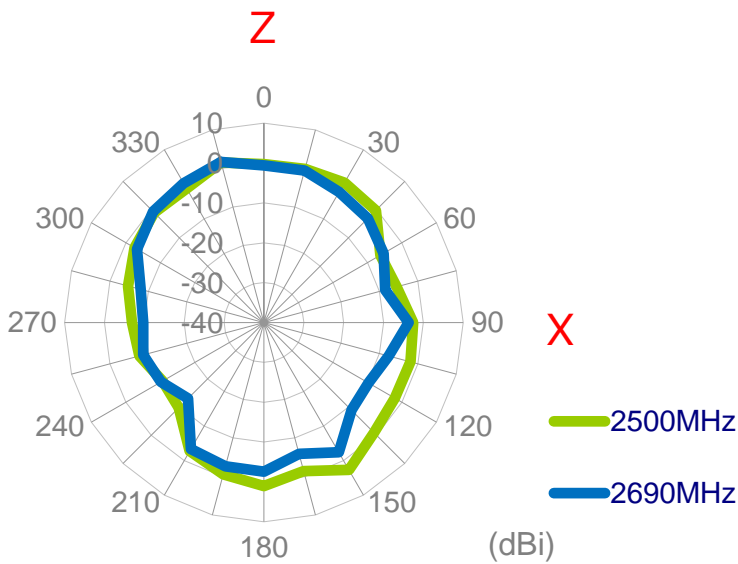
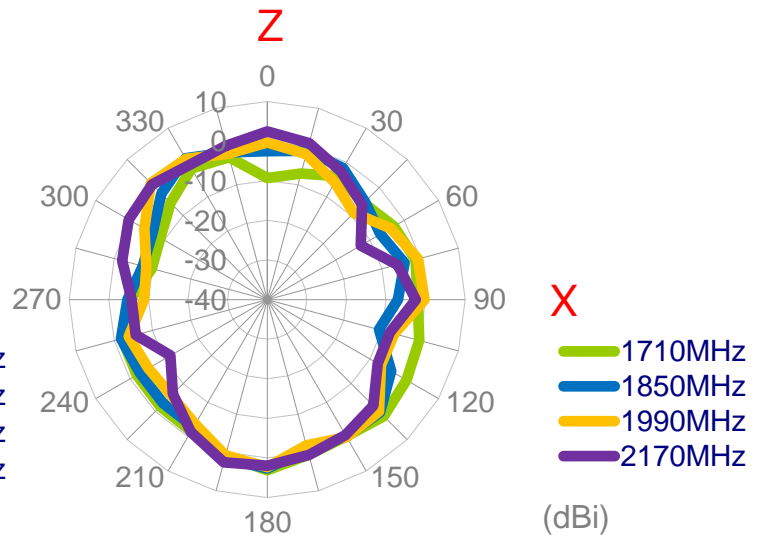
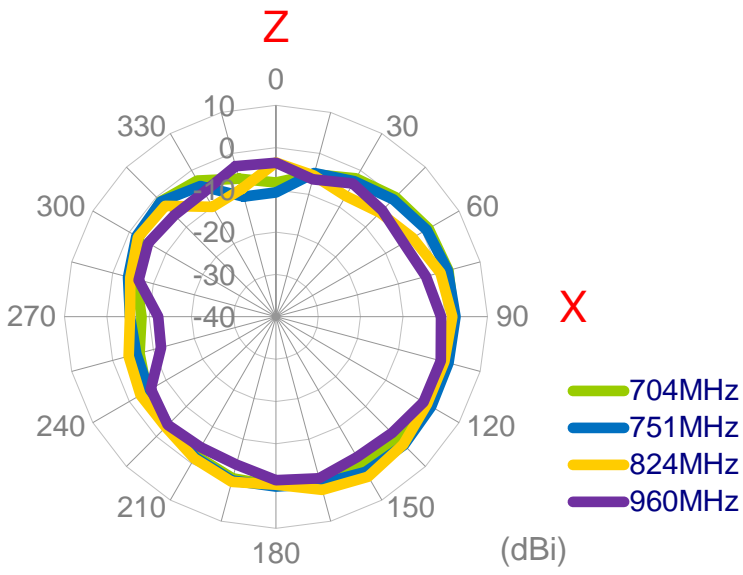

YZ Plane

Z

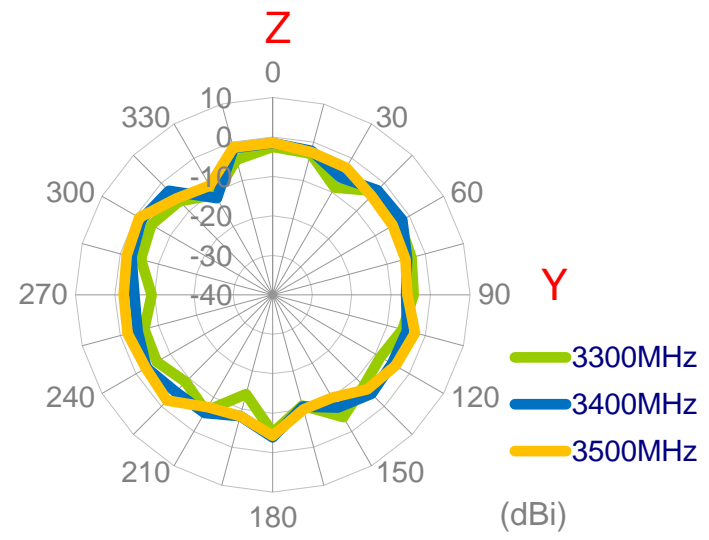
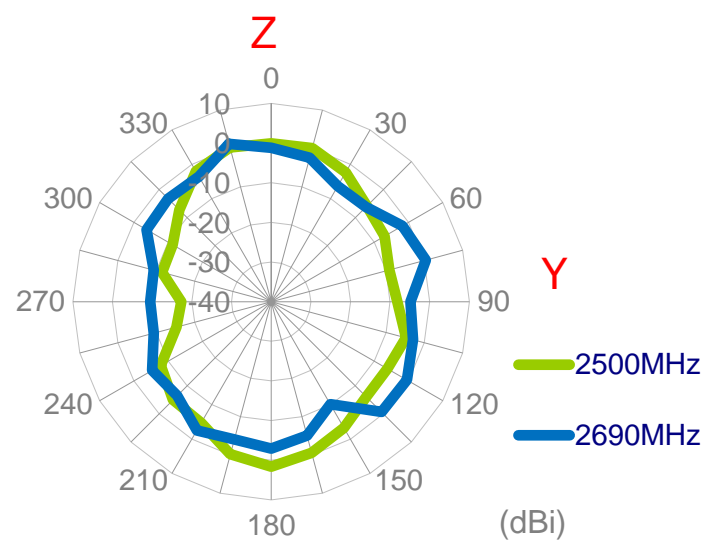
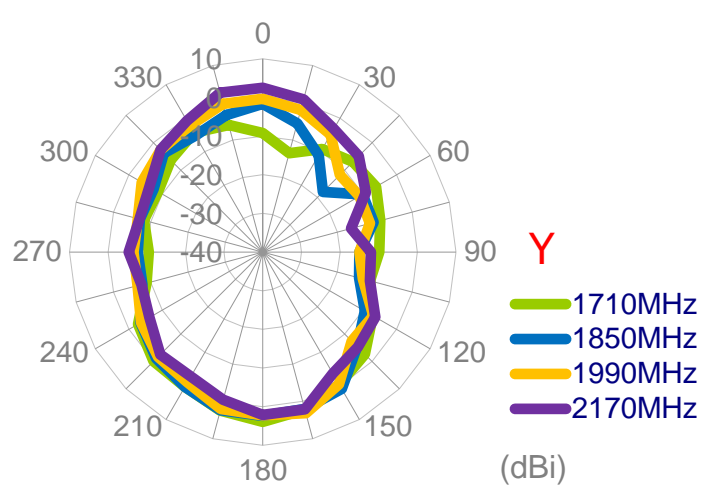
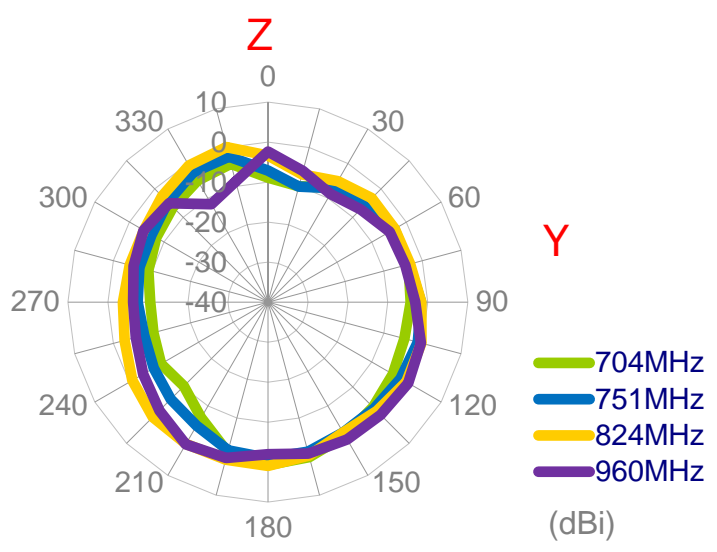

3.1.33 3D Radiation Pattern
 LTE MIMO1 with 3M cable length on the wall

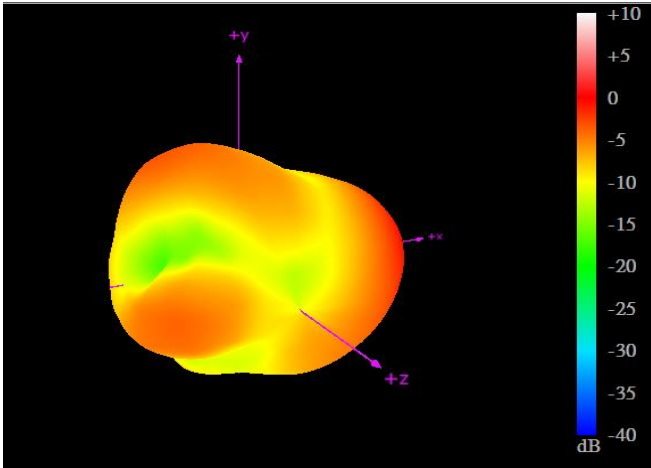

704MHz

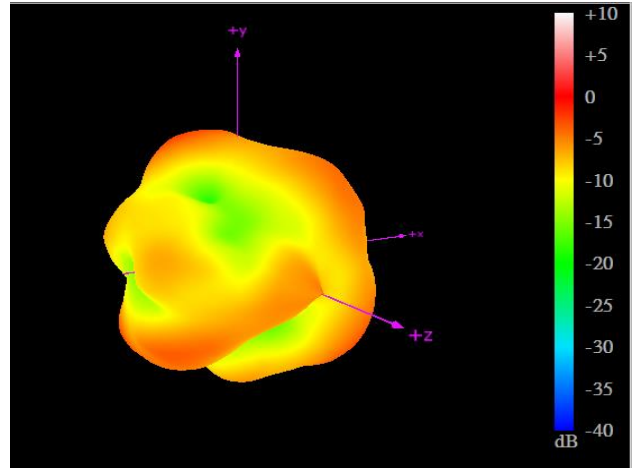

960MHz

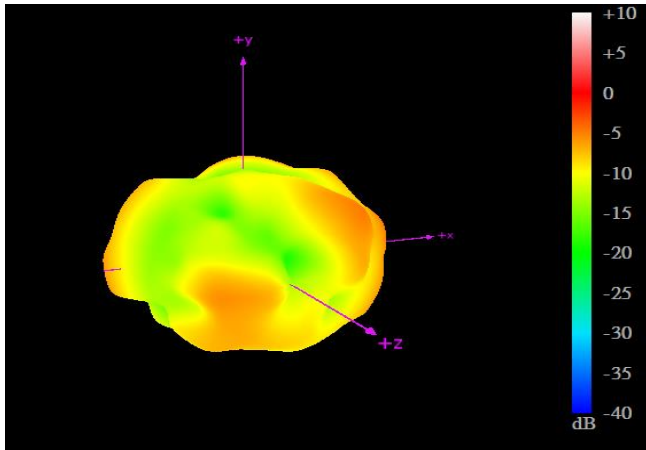

1710MHz

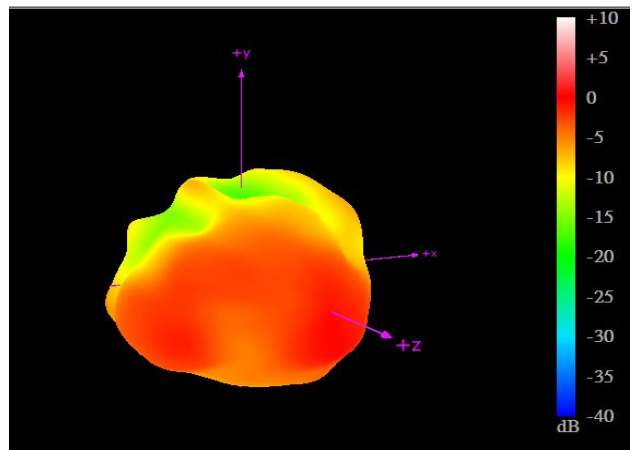

2170MHz

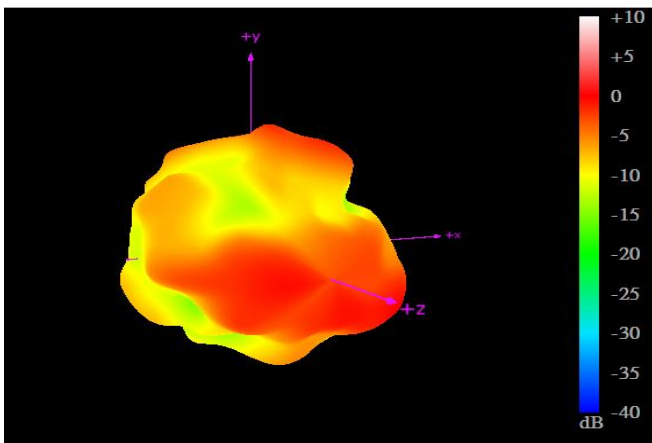

2690MHz

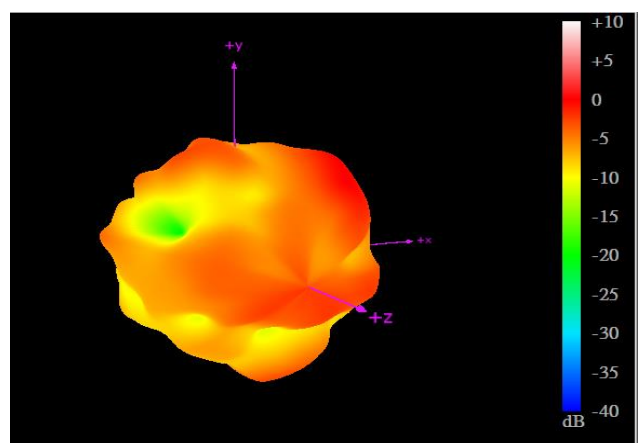

3500MHz

3.1.34 2D Radiation Pattern
 LTE MIMO2 with 3M cable length on the wall

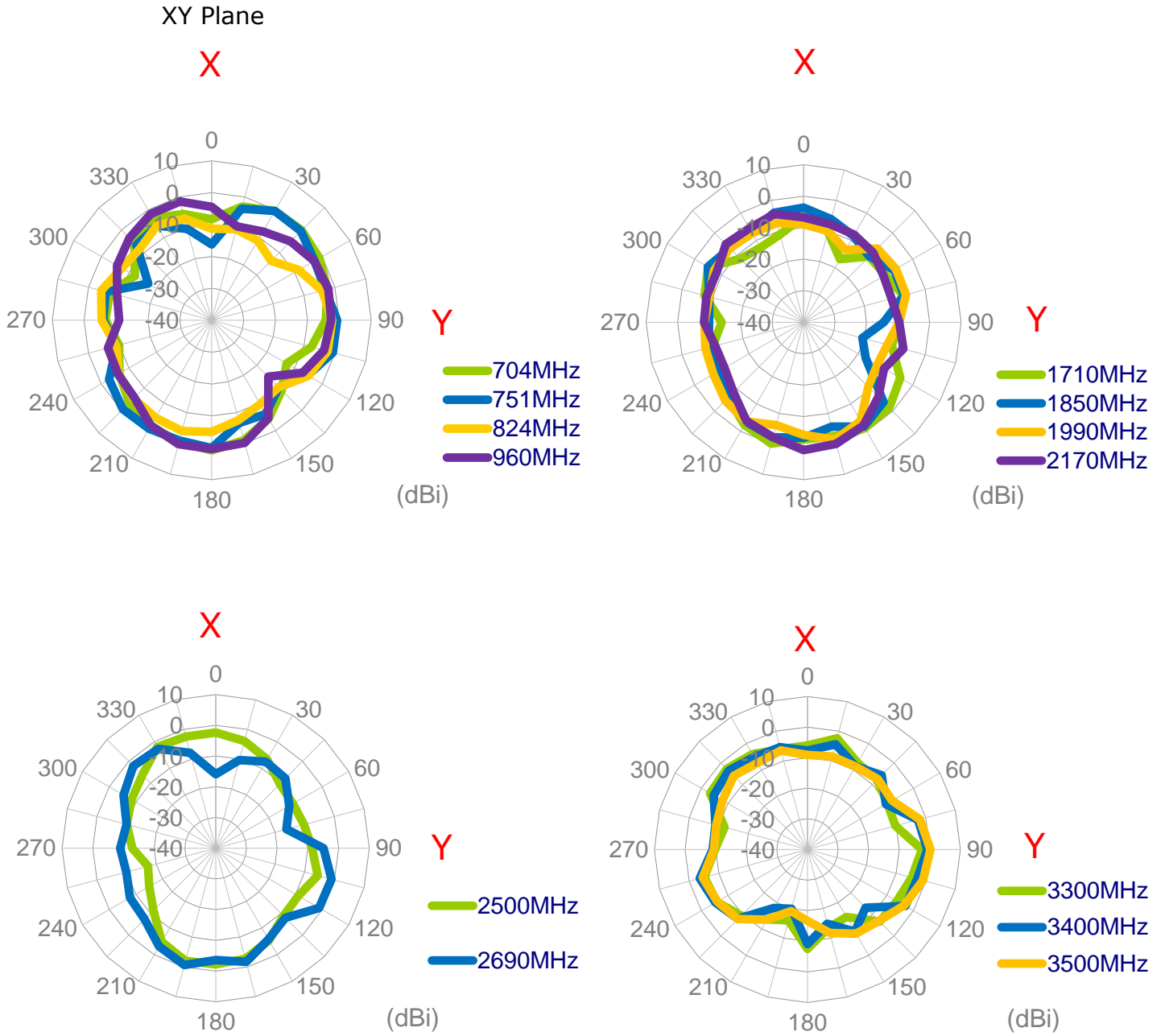

XZ Plane

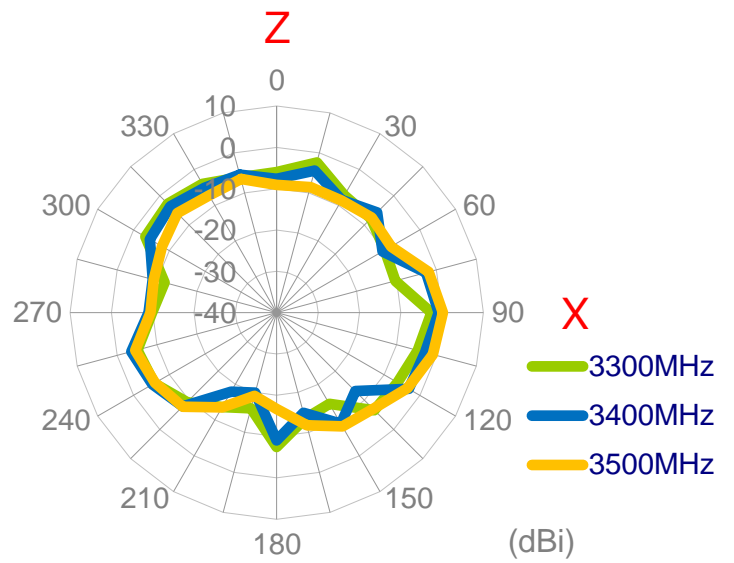
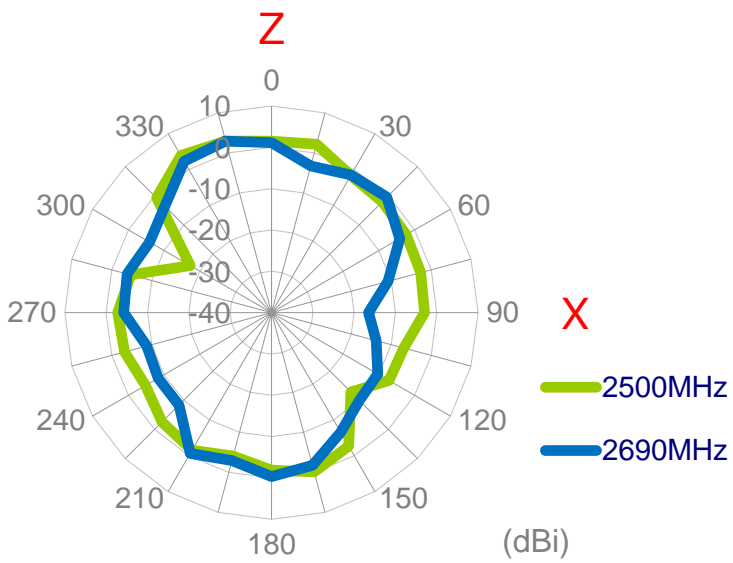
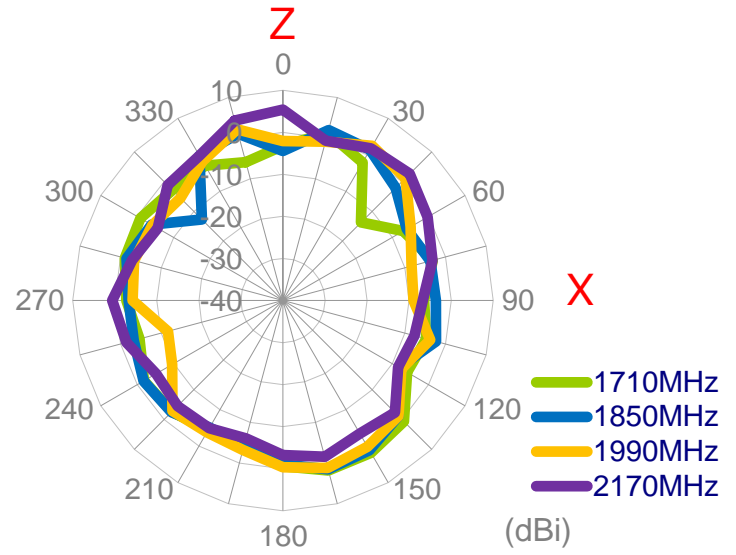
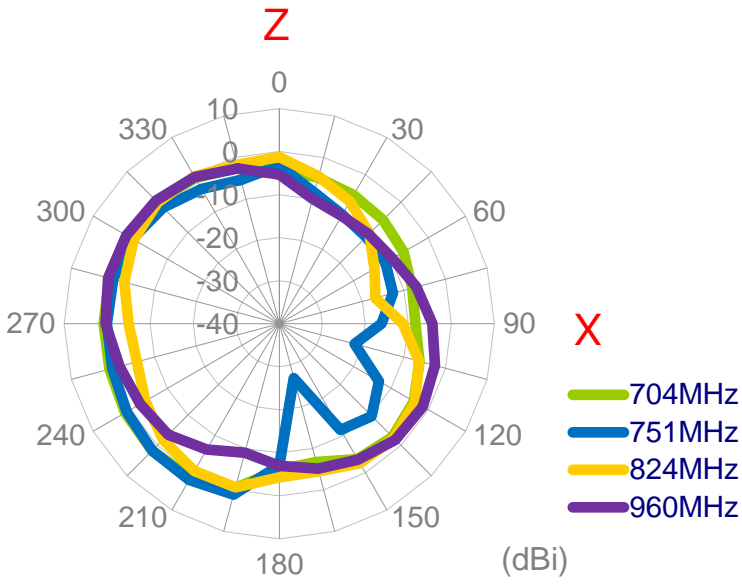

YZ Plane

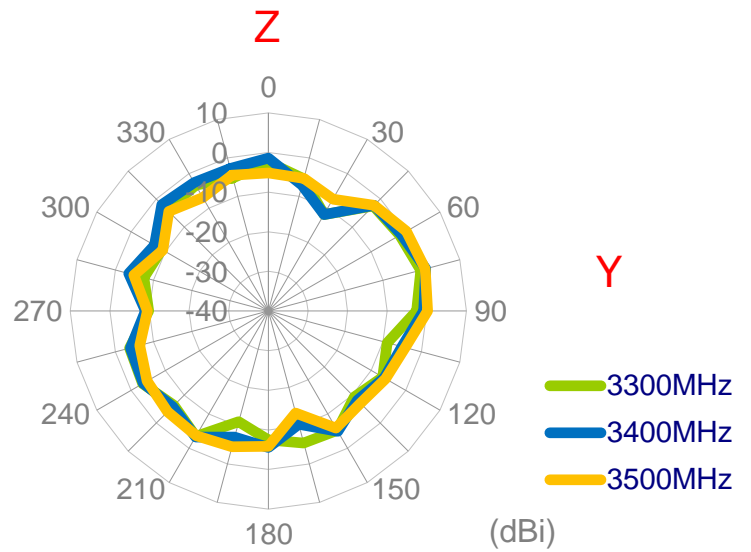
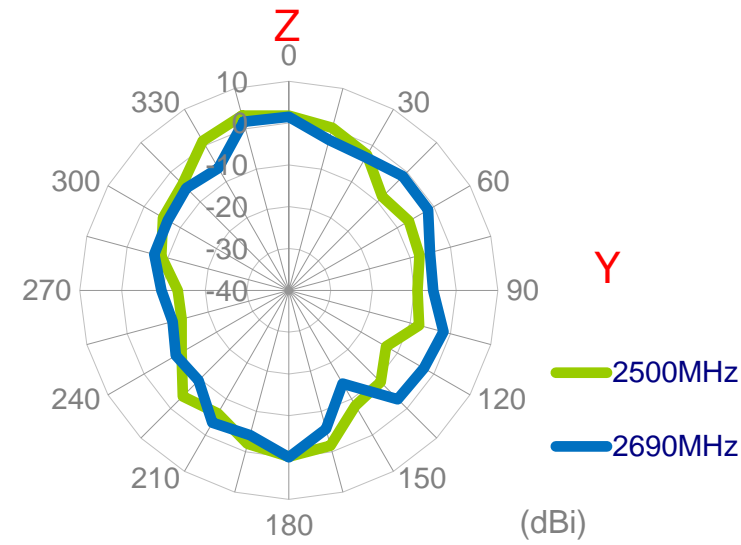
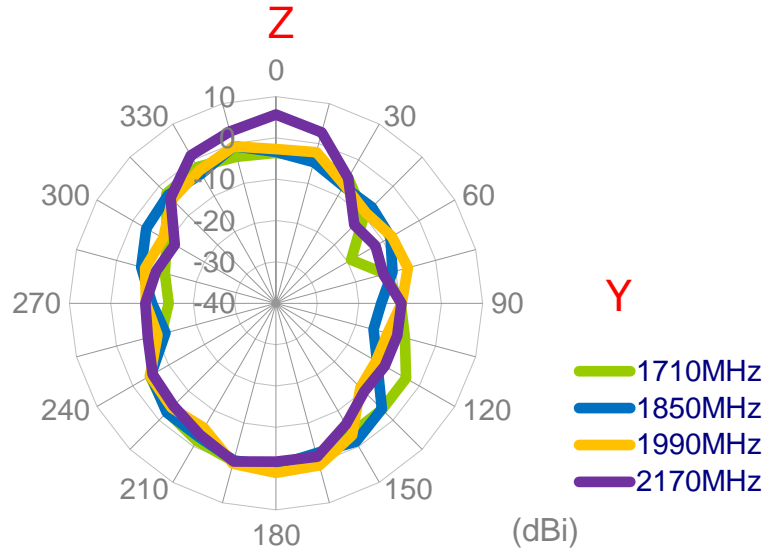
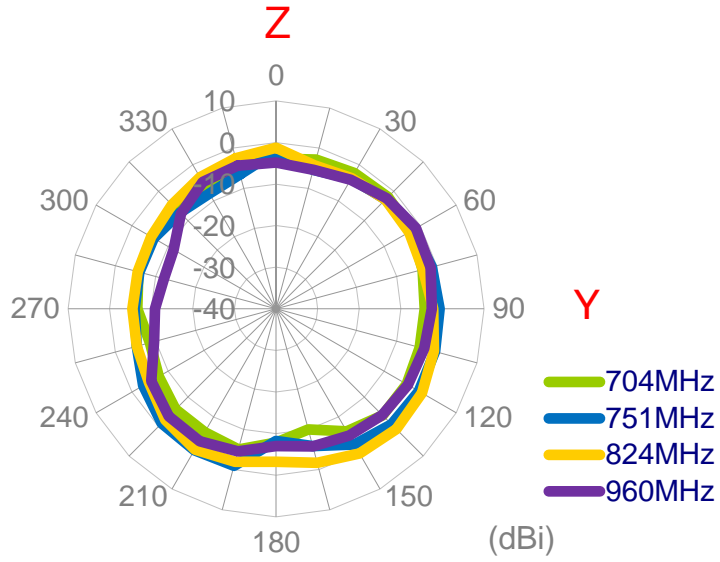

3.1.35 3D Radiation Pattern
 LTE MIMO2 with 3M cable length on the wall

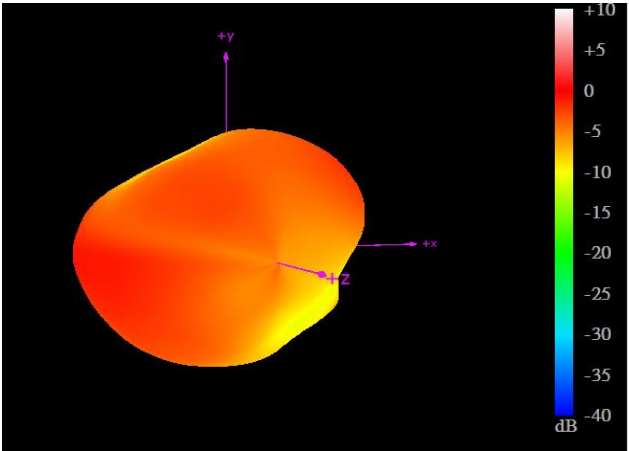

704MHz

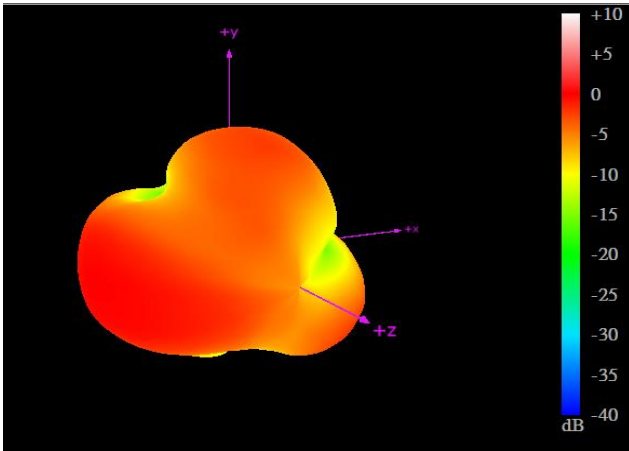

960MHz

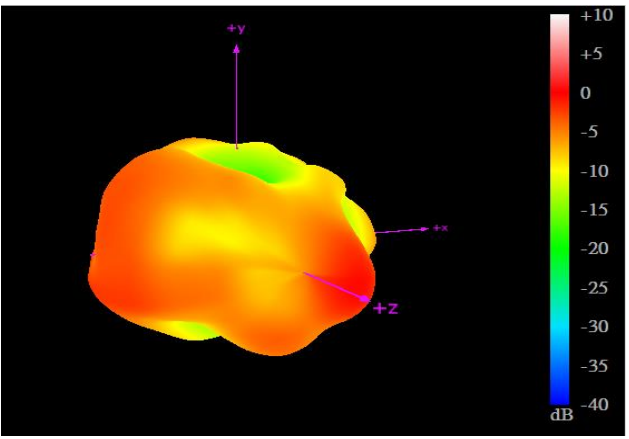

1710MHz

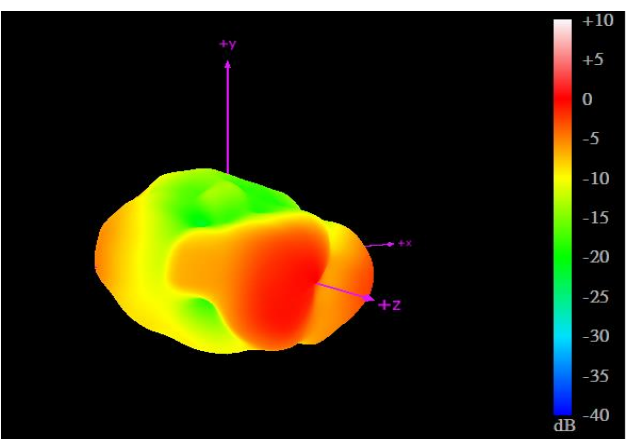

2170MHz

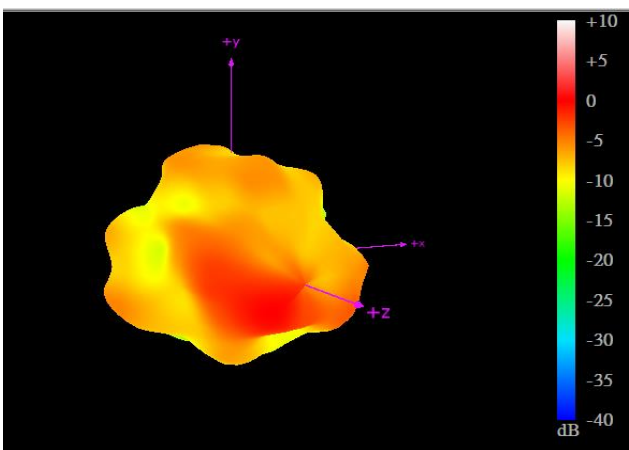

2690MHz

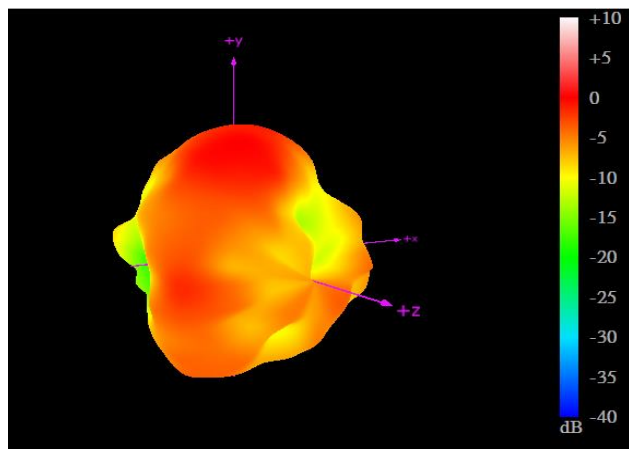

3500MHz

4. Mechanical Drawing (unit:mm)

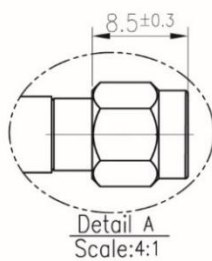
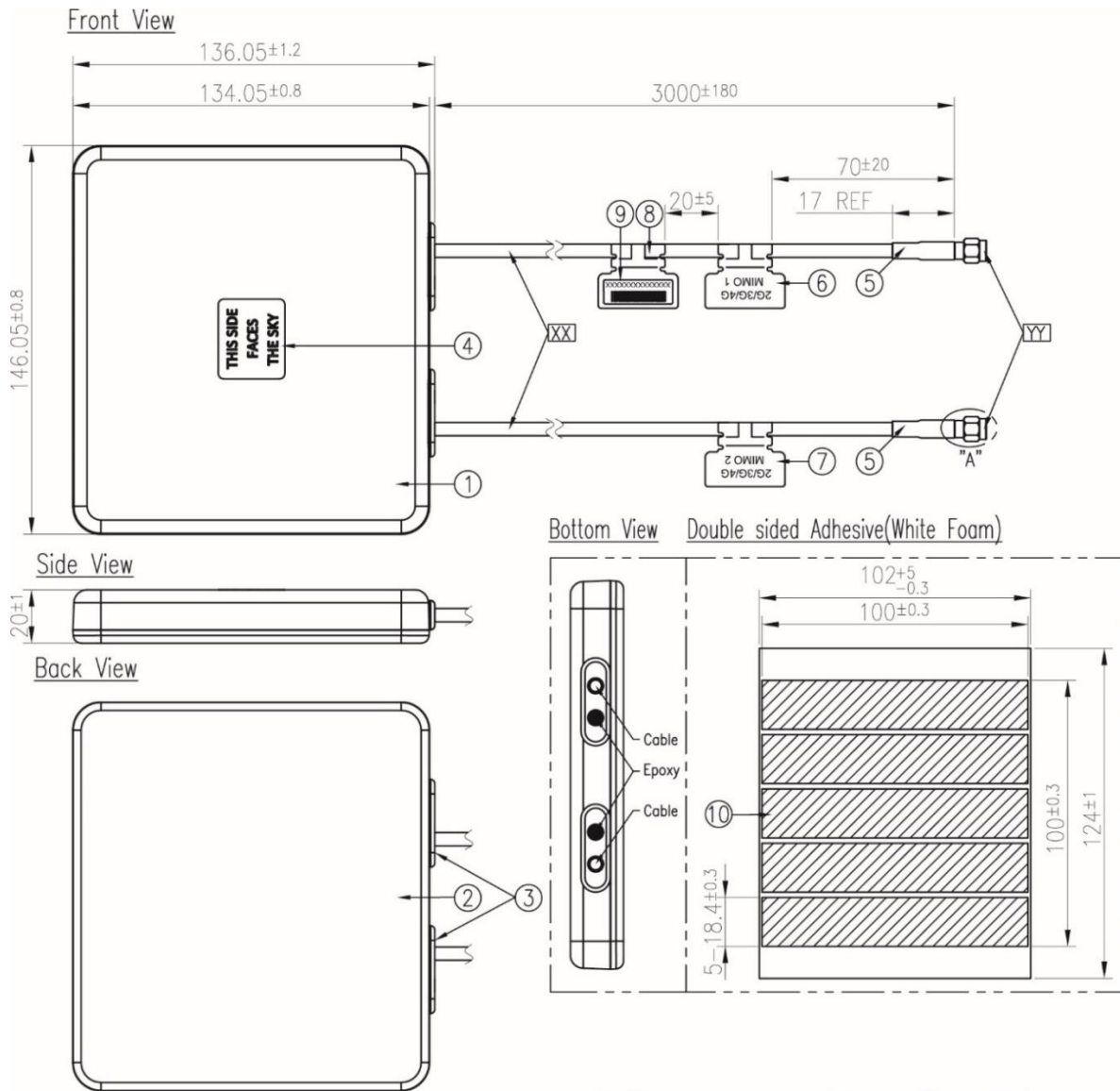

	Name	Material	Finish	QTY
1	Top Housing	ASA	Black	1
2	Bottom Housing	ASA	Black	1
3	Rubber-2 Holes	Silicone Rubber	Black	2
4	Clear Label	PET	Transparent	1
5	Heat Shrink Tube	PE	Black	2
6	2G/3G/4G MIMO1 Label	PEPA	Light Gray	1
7	2G/3G/4G MIMO2 Label	PEPA	White	1
8	Empty Label	PEPA	White	1
9	Barcode Label	PET	White	1
10	Double sided Adhesive(White Foam)	3M VHB 4615 0.4t	White Liner	1

	Name	Material	Finish	QTY
XX	Cable Type	CFD200	Black	2
YY	Connector Type	SMA(M)ST	Au Plated	2

5. Packaging

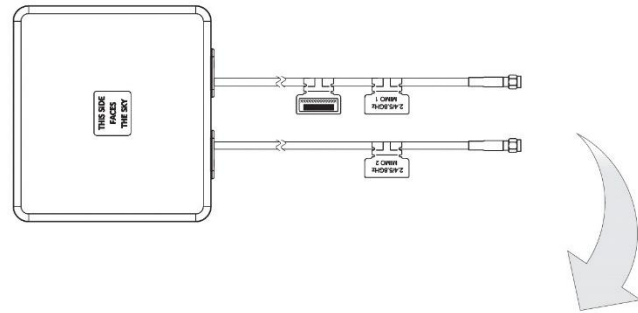

1 No. MA912.A.BI.001 per small box
 Box Dimensions - 260 x 235 x 105mm
 Weight - 0.75Kg

8 pcs MA912.A.BI.001 per carton
 Carton Dimensions - 540 x 490 x 240mm
 Weight - 6.6Kg

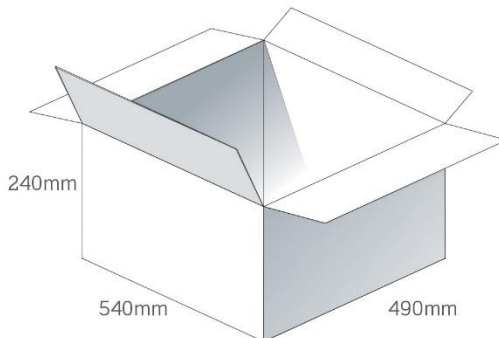

Pallet Dimensions 1200*1000*1400mm
 20 Cartons per Pallet
 4 Cartons per layer
 5 Layers

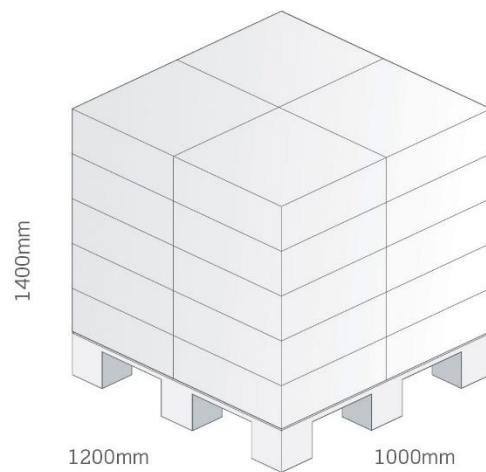

6. Application Note

The MA912 antenna performance with different cable lengths is shown below.

6.1 In free space (LTE)

6.1.1 Return Loss LTE MIMO 1

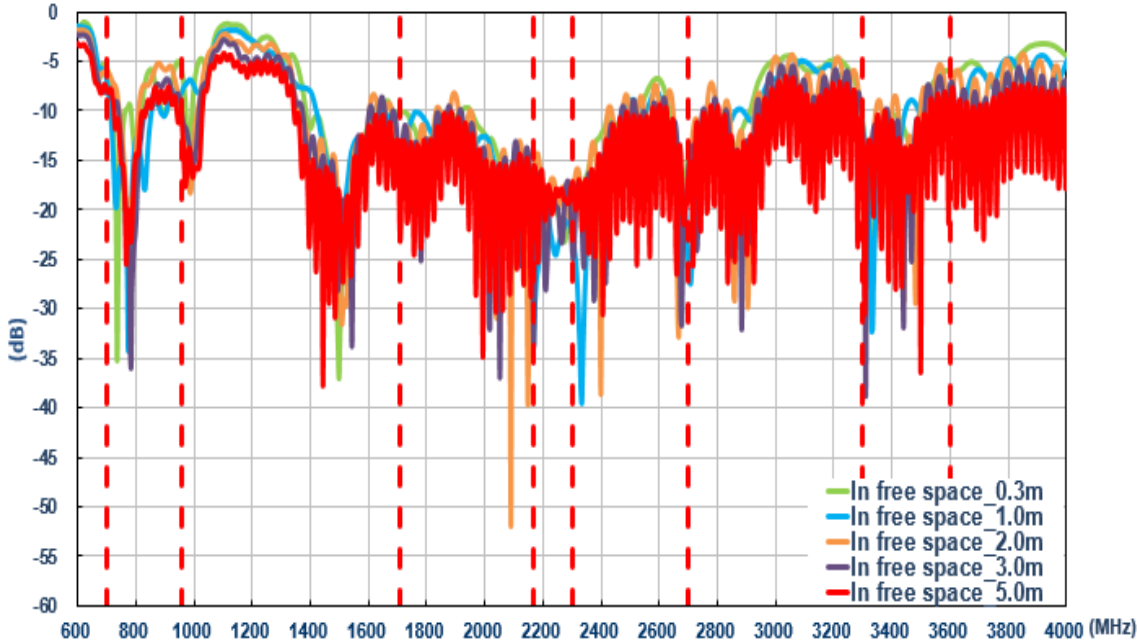

6.1.2 Return Loss LTE MIMO 2

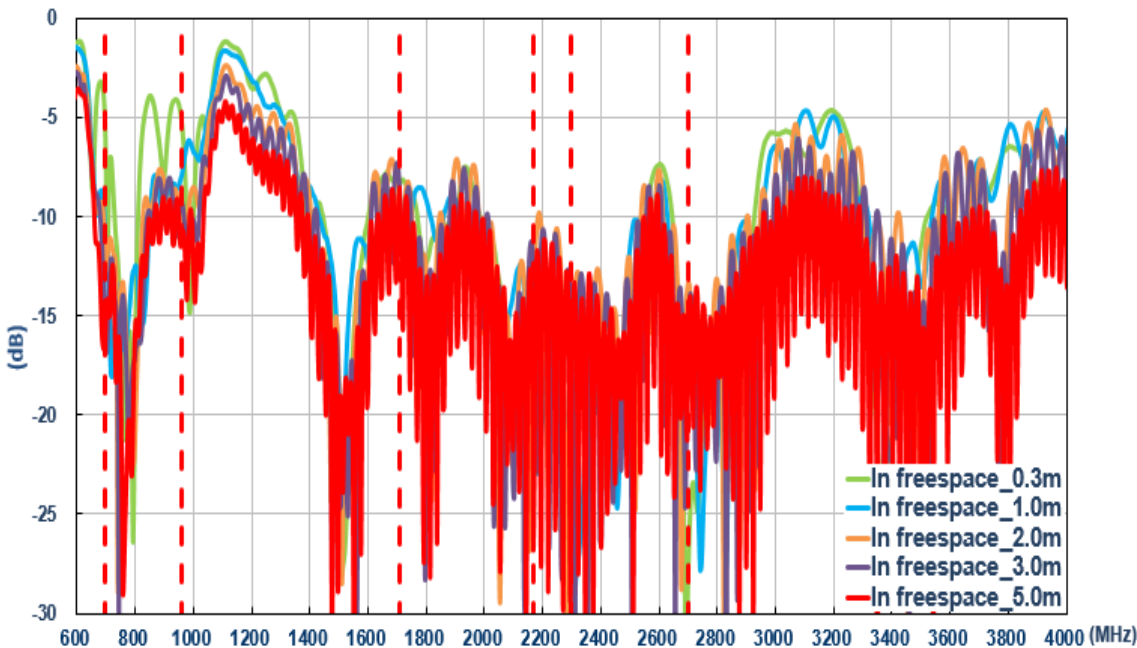

6.1.3 Isolation (LTE antenna)

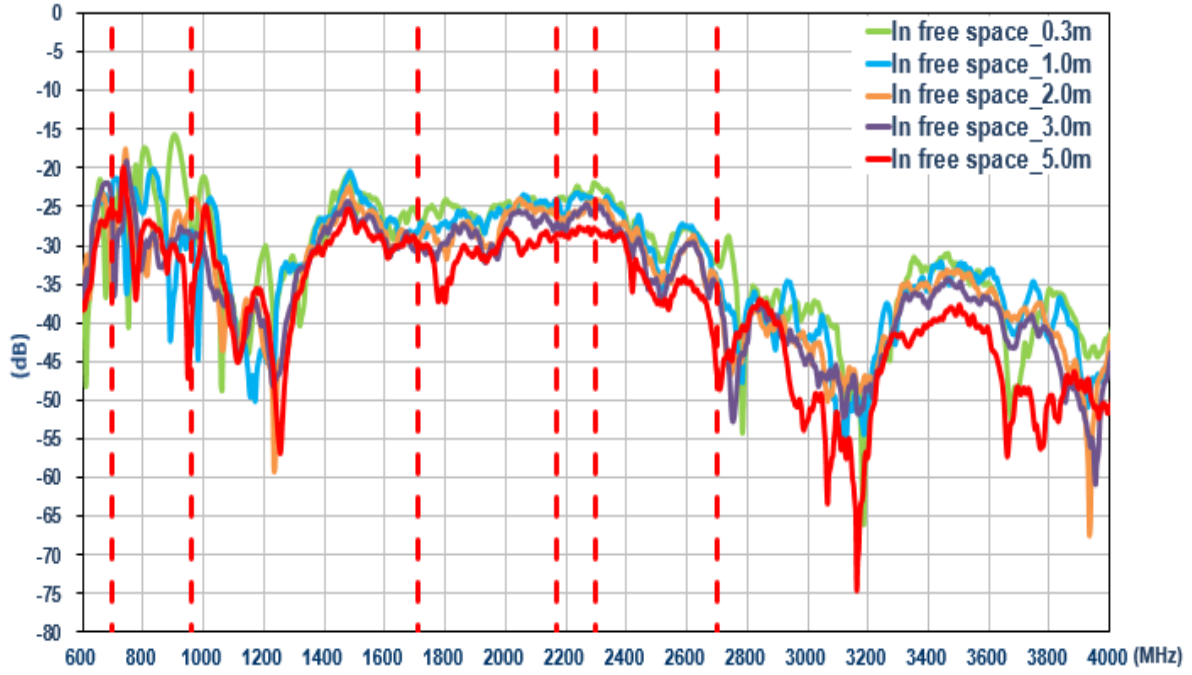

6.1.4 Efficiency (MIMO 1)

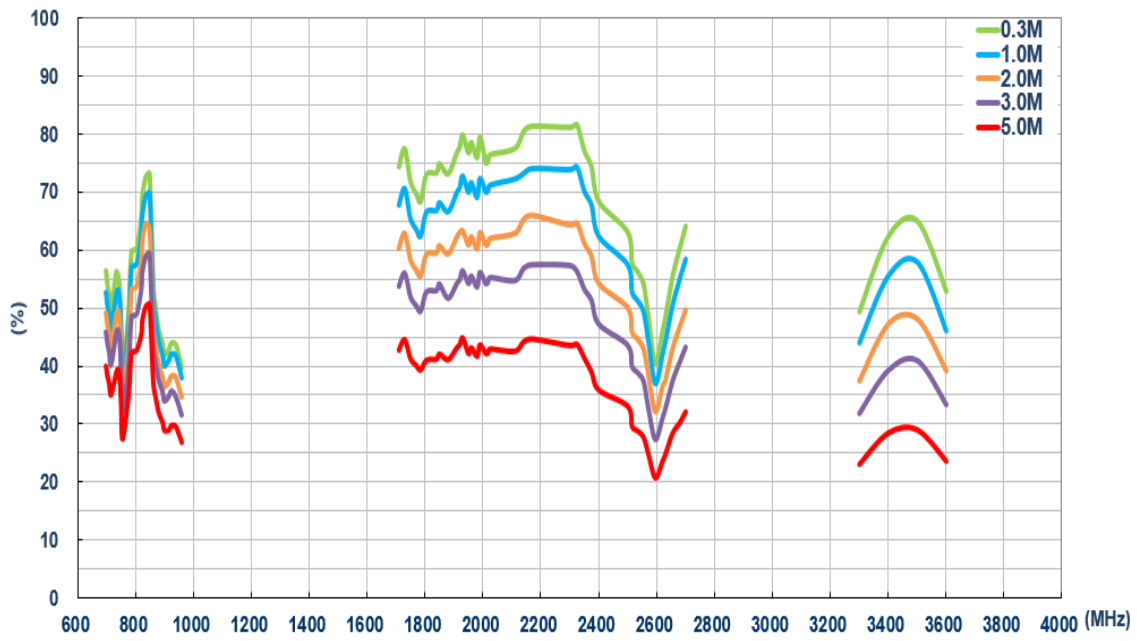

6.1.5 Efficiency (MIMO 2)

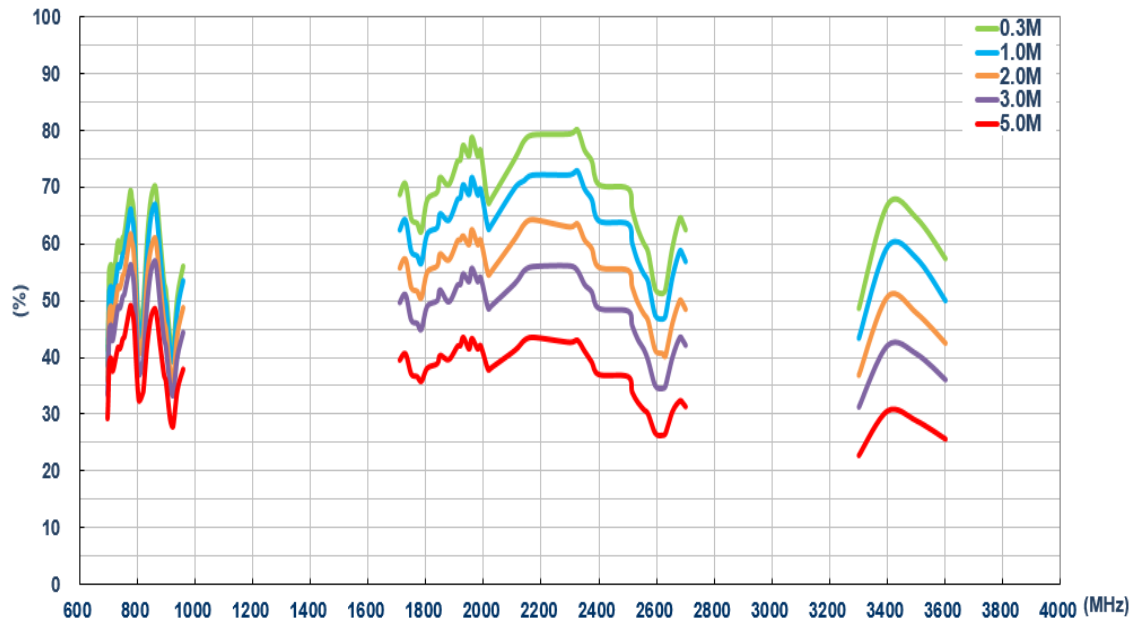

6.1.6 Average Gain (MIMO 1)

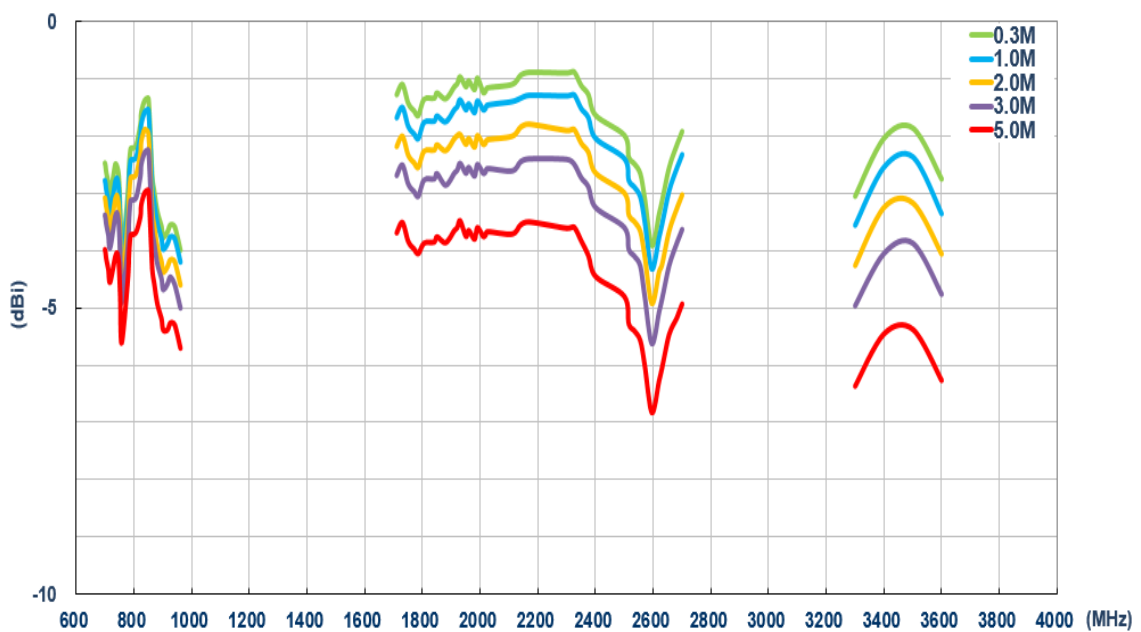

6.1.7 Average Gain (MIMO 2)

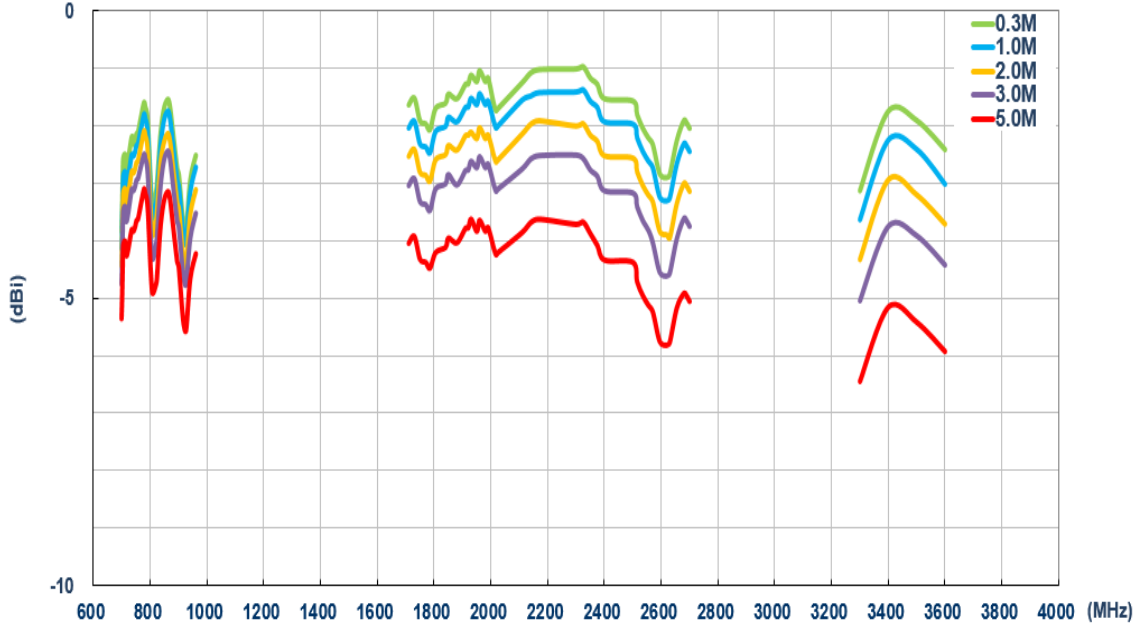

6.1.8 Peak Gain (MIMO 1)

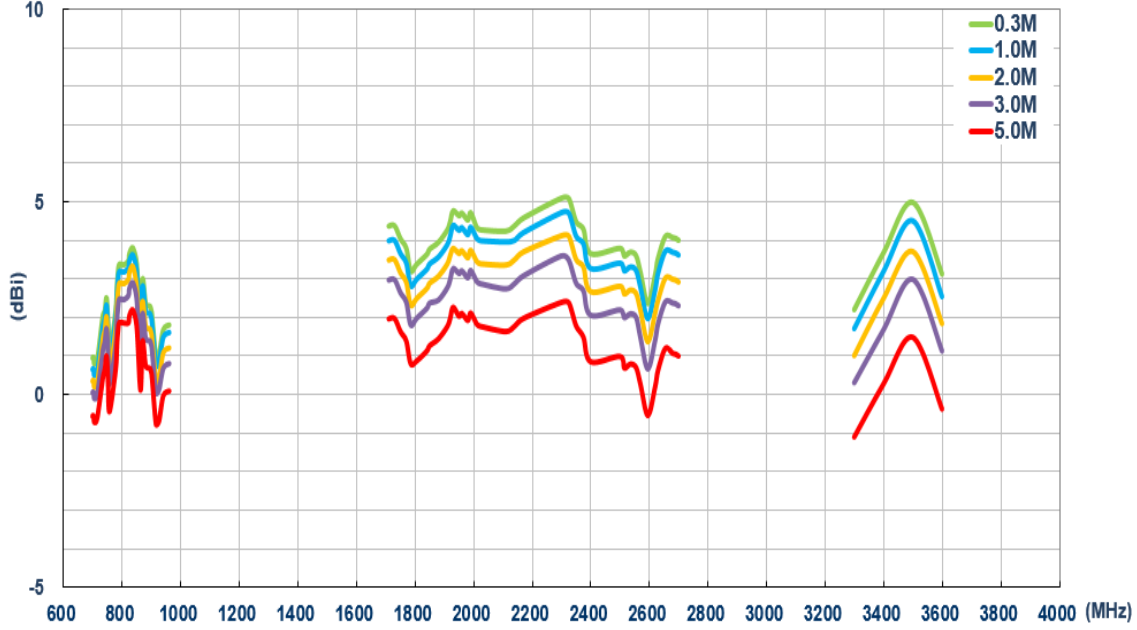

6.1.9 Peak Gain (MIMO 2)

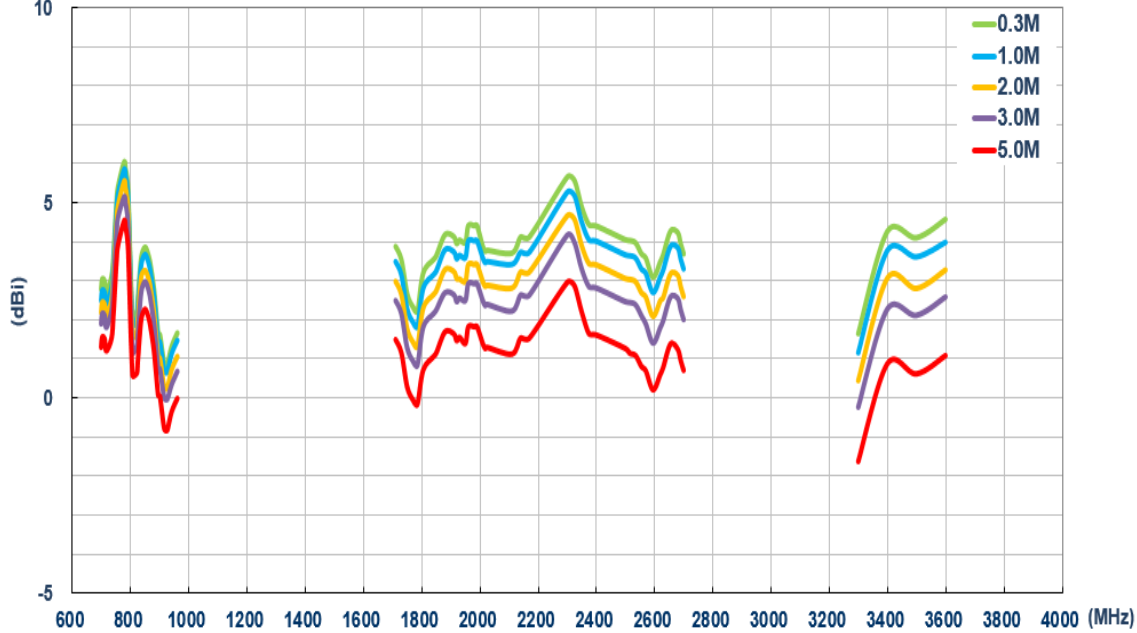

6.2 On the ABS (LTE)

6.2.1 Return Loss LTE MIMO 1

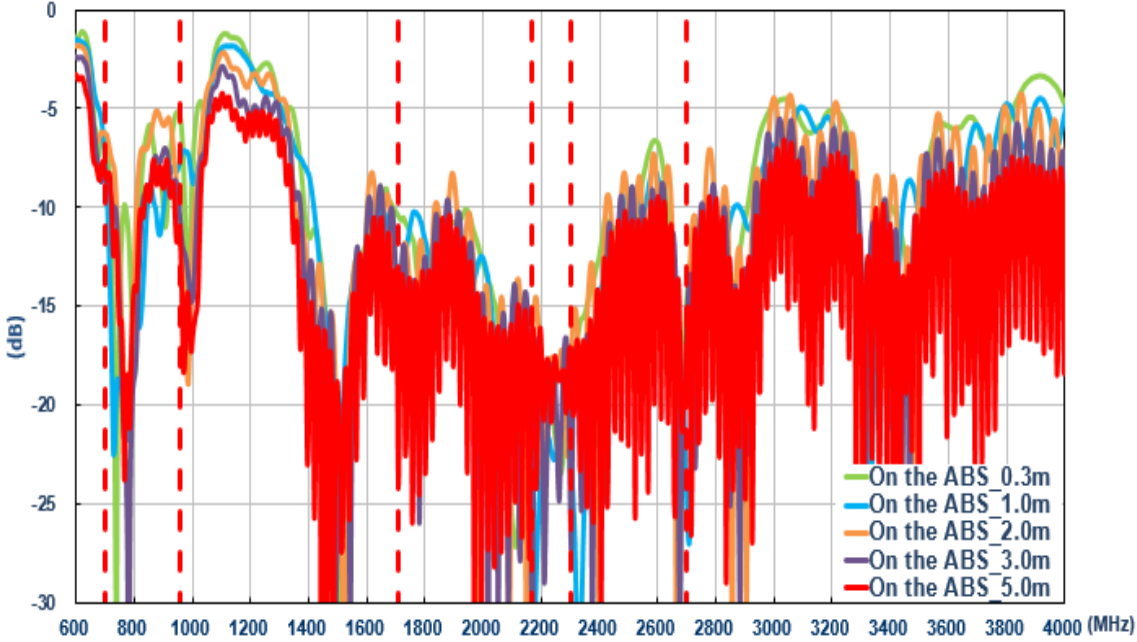

6.2.2 Return Loss LTE MIMO 2

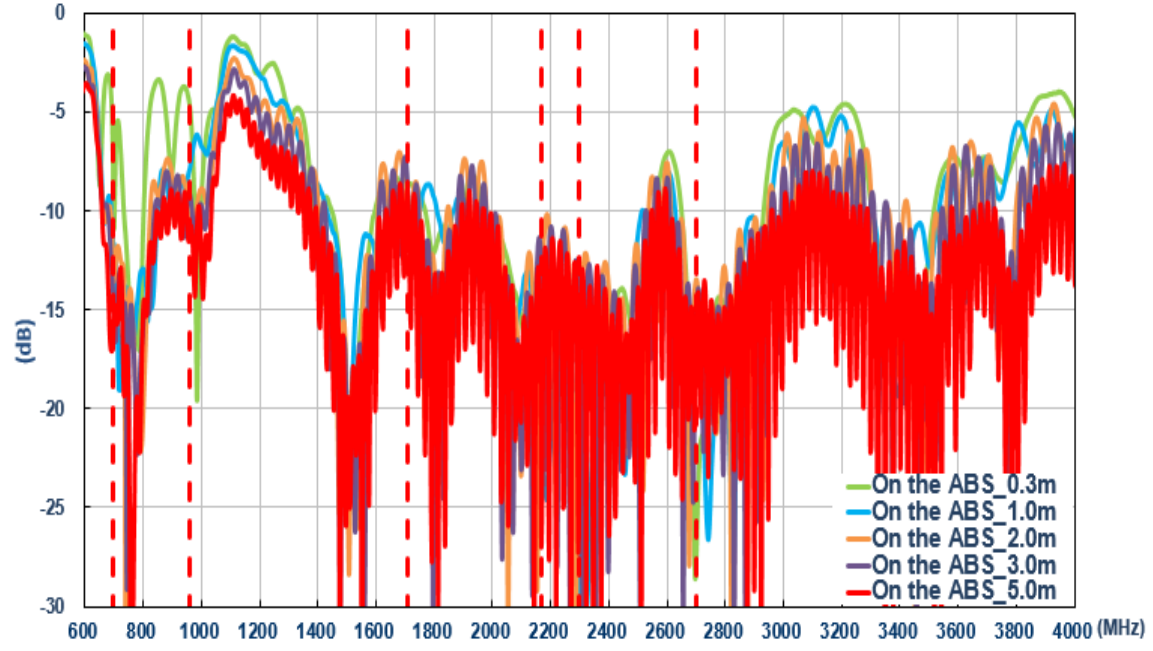

6.2.3 Isolation LTE antenna

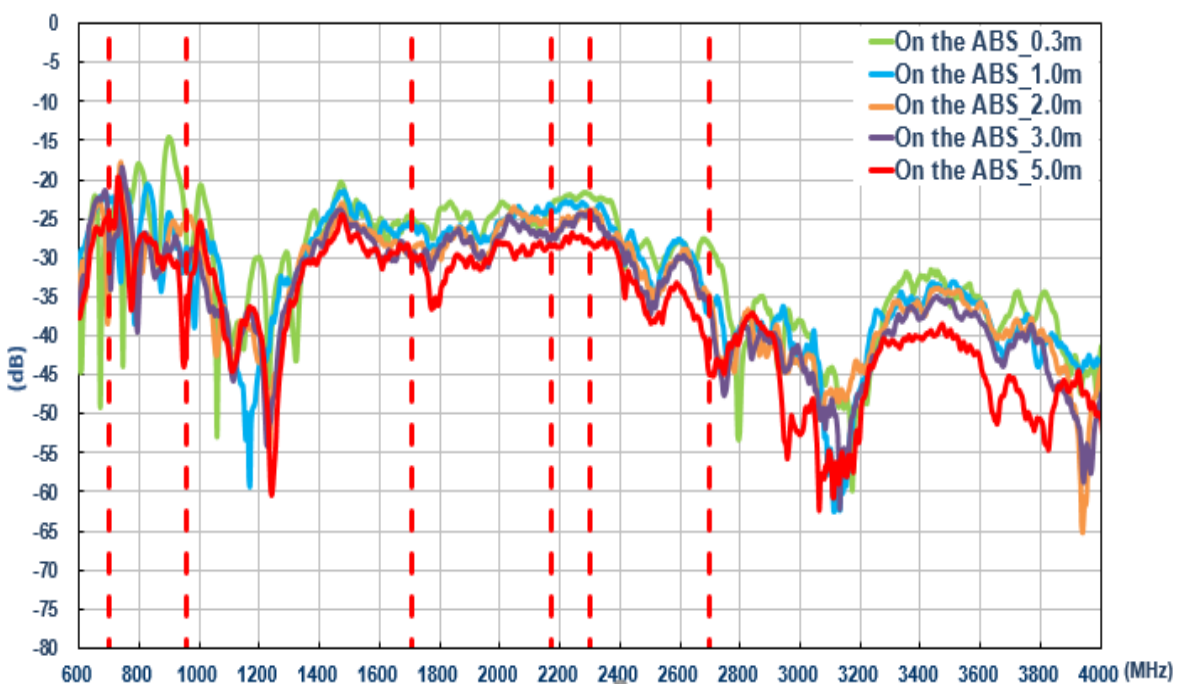

6.2.4 Efficiency MIMO 1

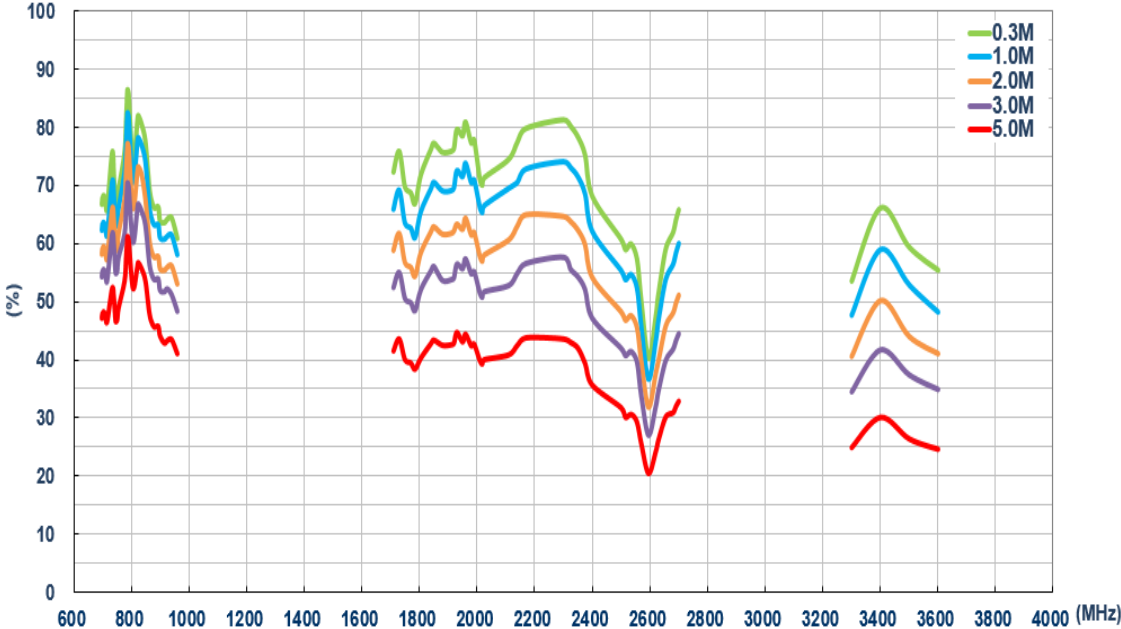

6.2.5 Efficiency MIMO 2

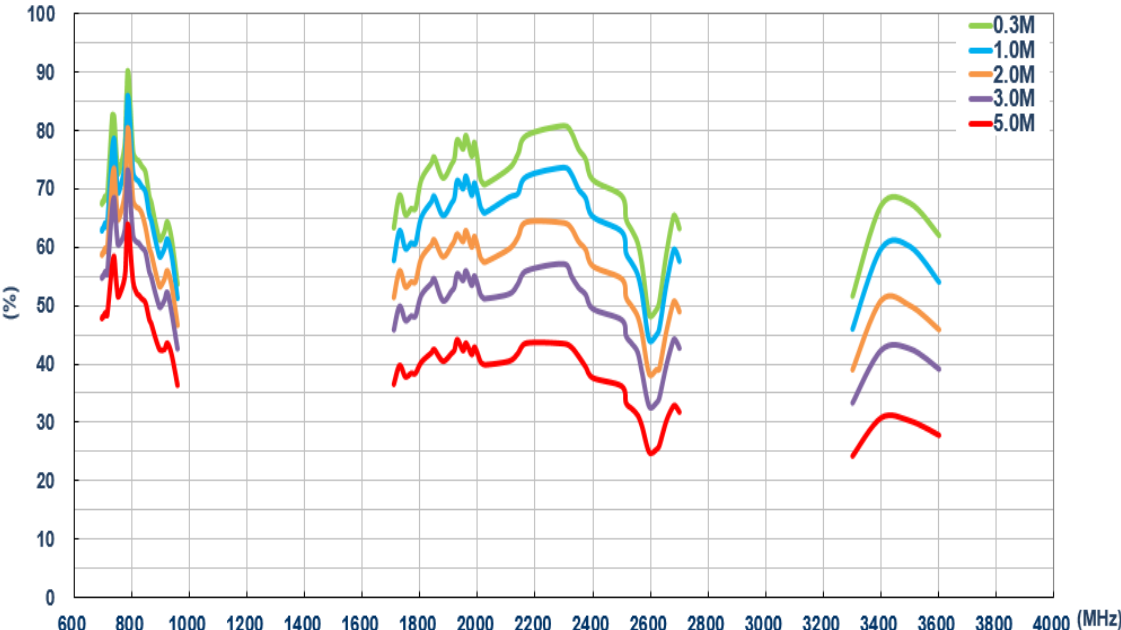

6.2.6 Average Gain MIMO 1

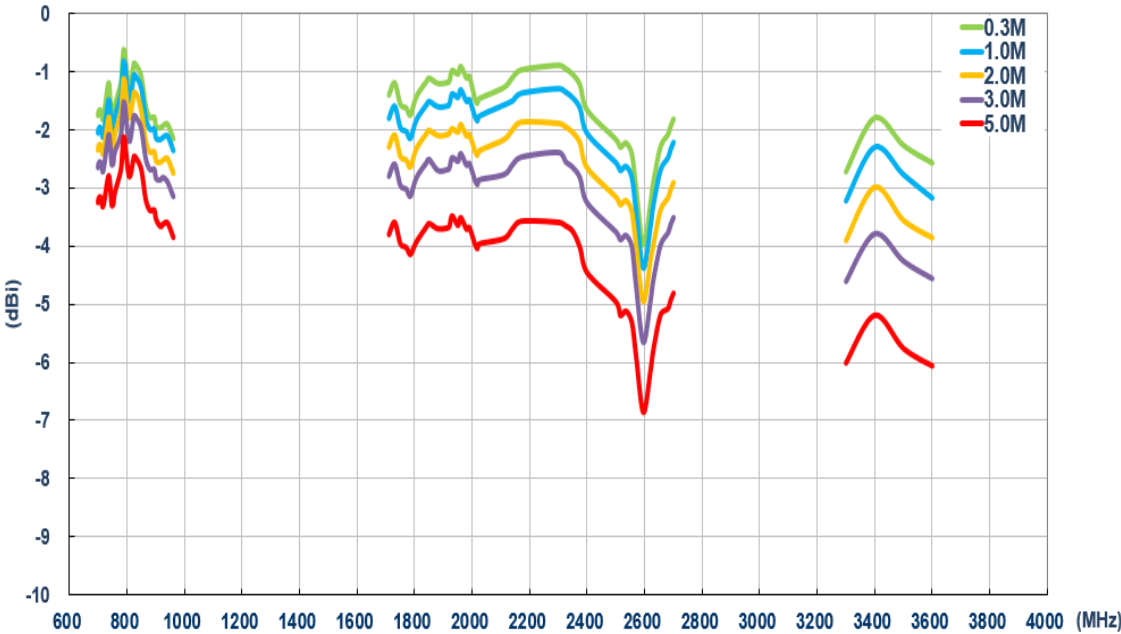

6.2.7 Average Gain MIMO 2

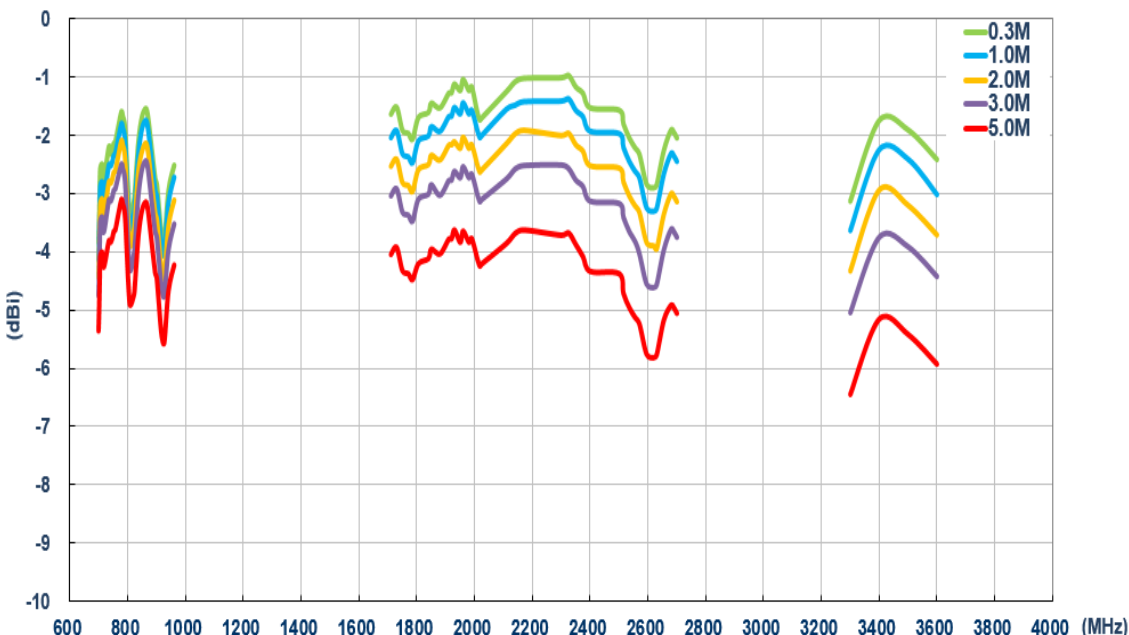

6.2.8 Peak Gain MIMO 1

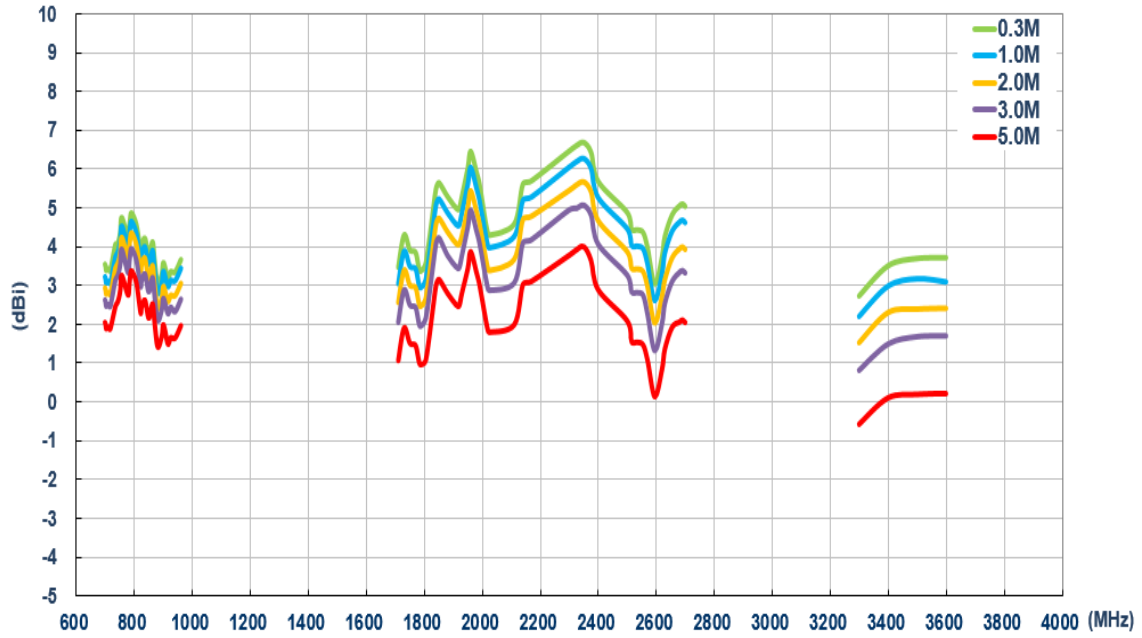

6.2.9 Peak Gain MIMO 2

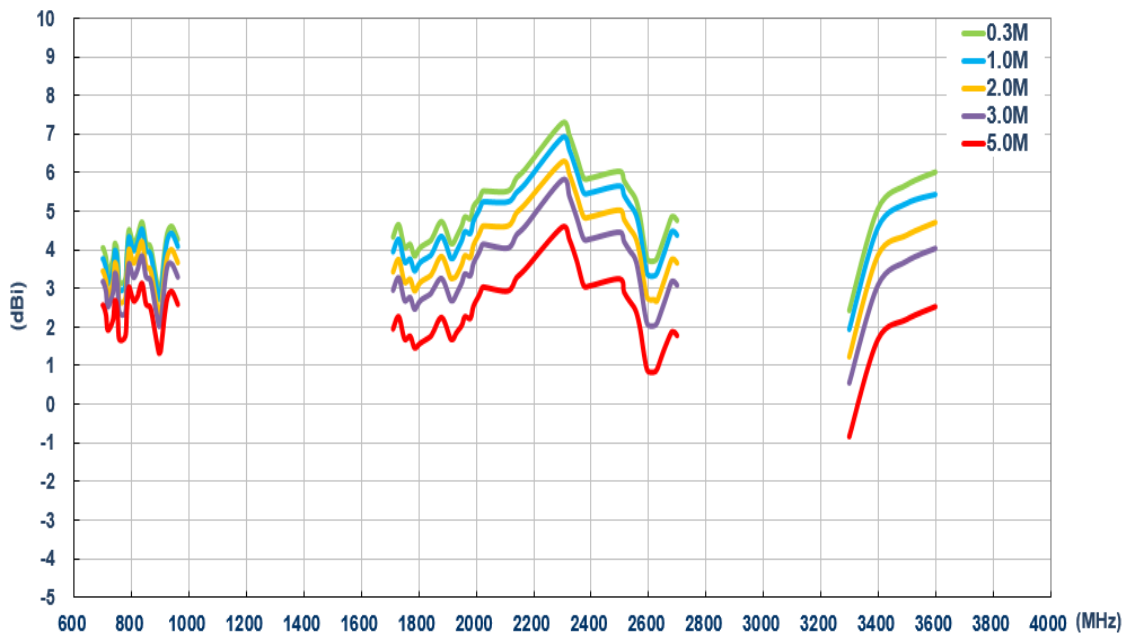

6.5 On the glass (LTE)

6.5.1 Return Loss (LTE MIMO 1)

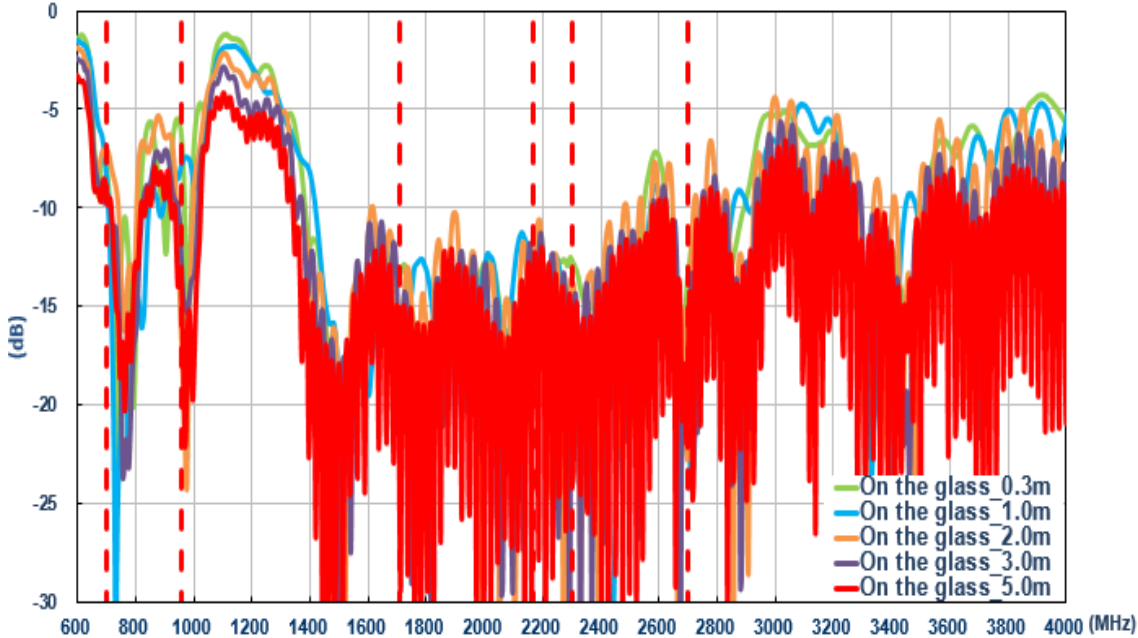

6.5.2 Return Loss (LTE MIMO 2)

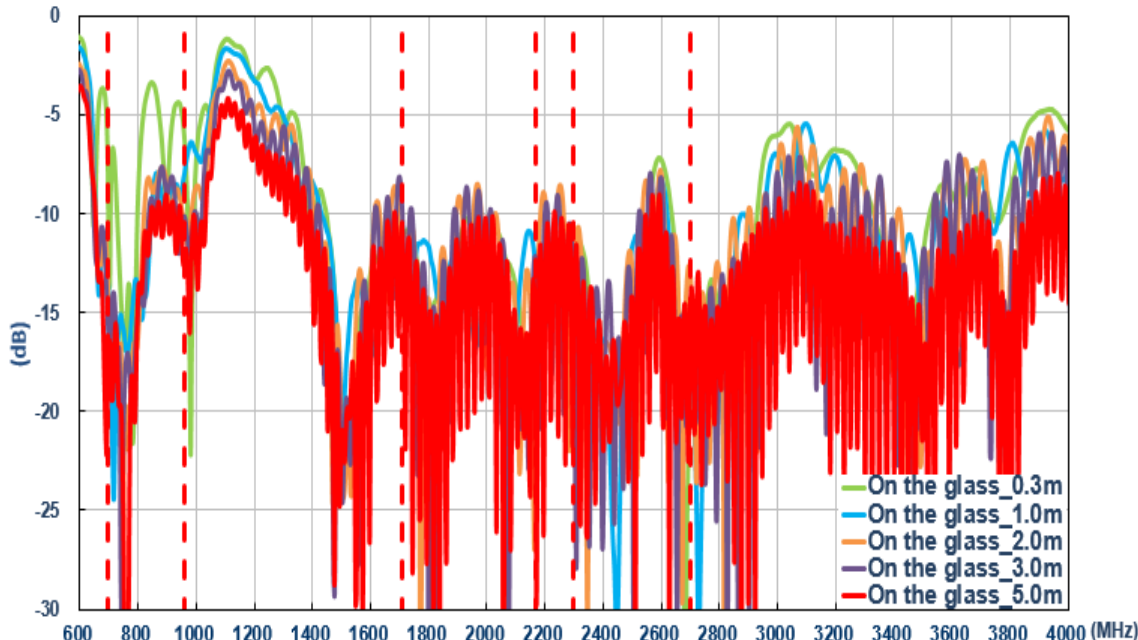

6.5.3 Isolation (LTE antenna)

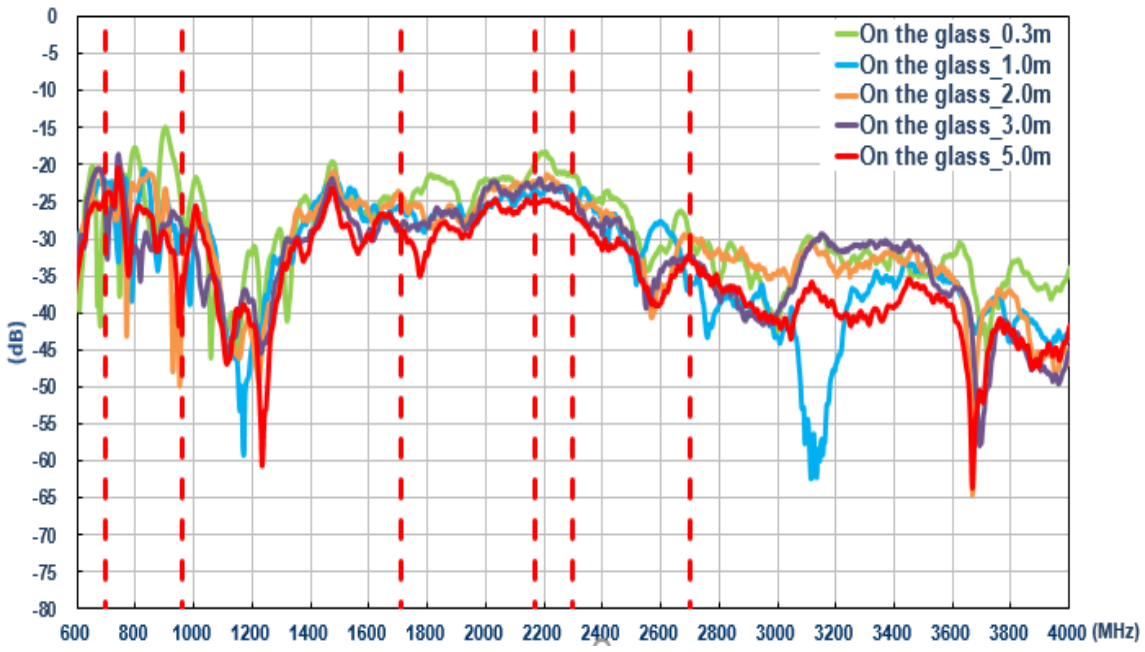

6.5.4 Efficiency (MIMO 1)

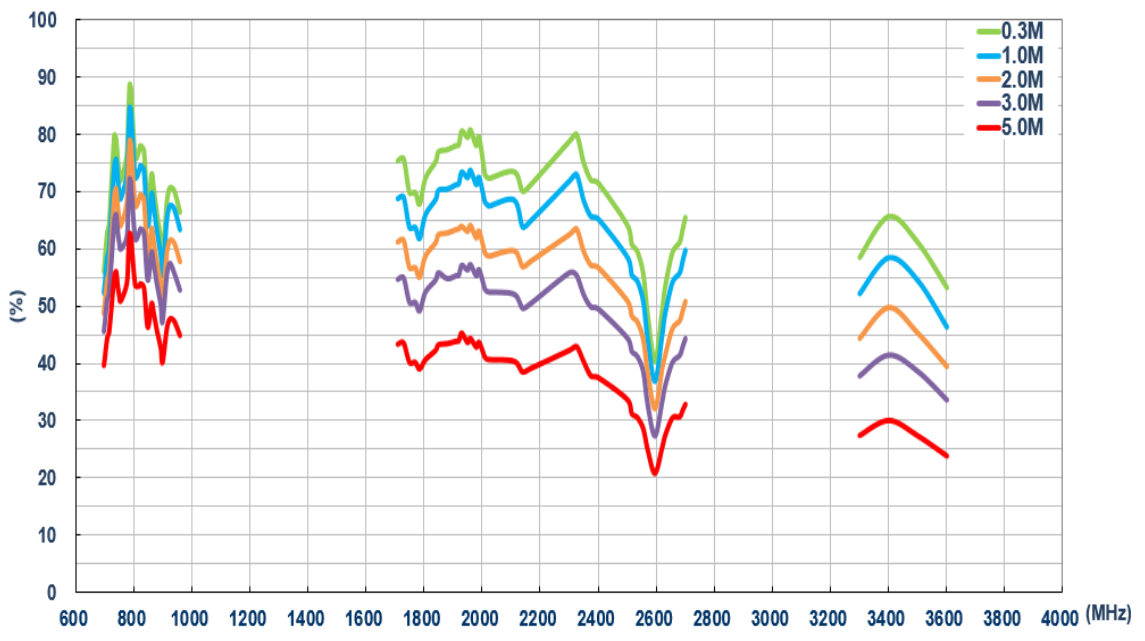

6.5.5 Efficiency MIMO 2

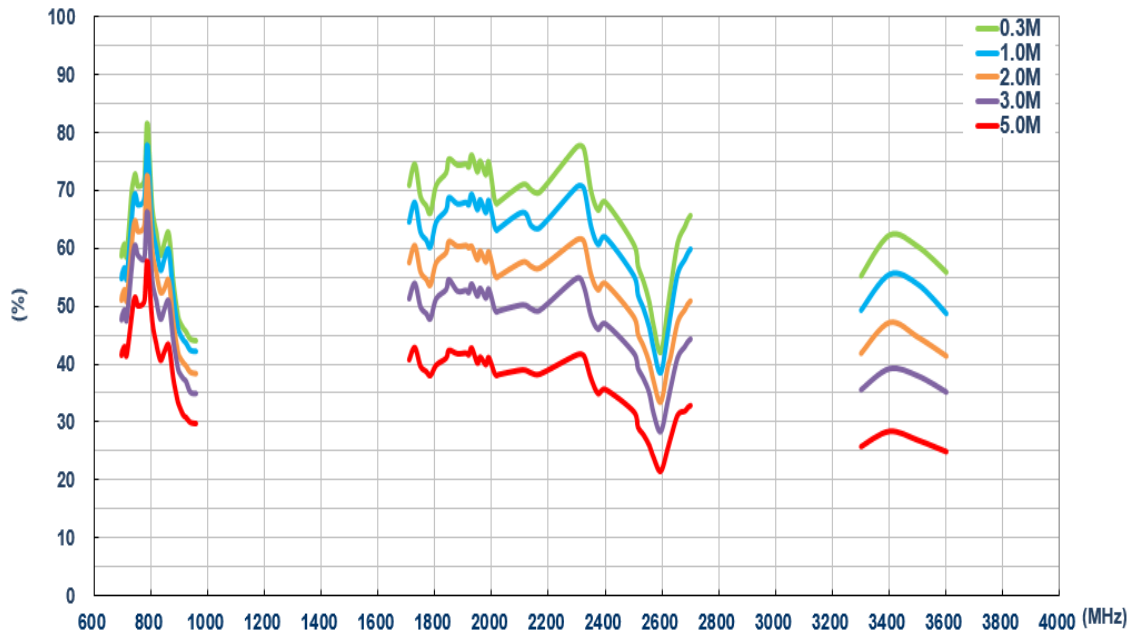

6.5.6 Average Gain MIMO 1

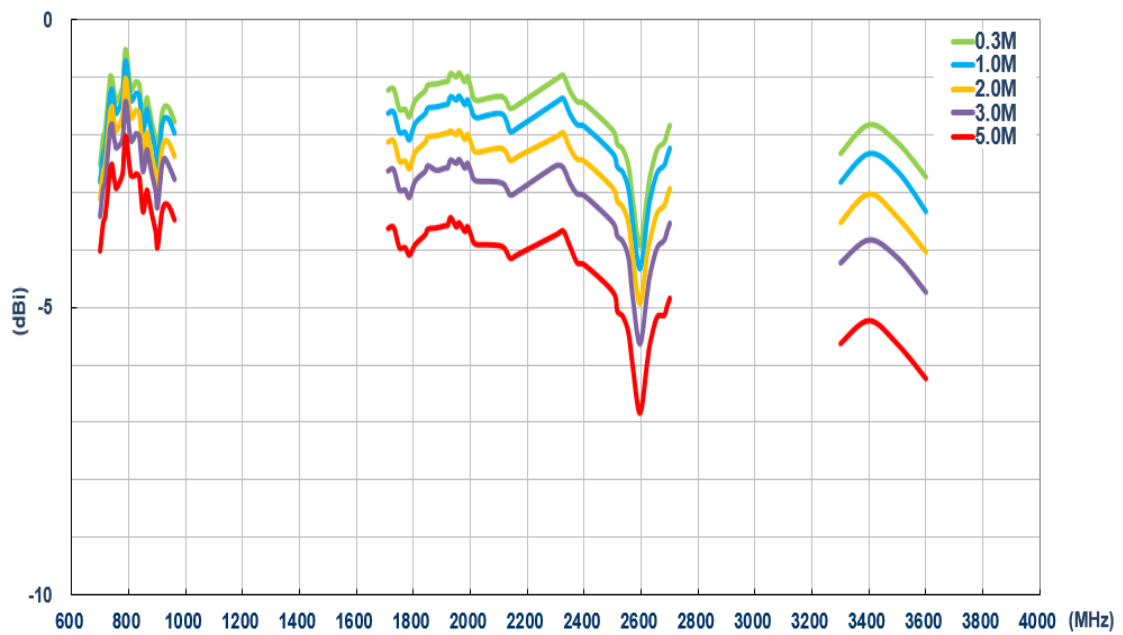

6.5.7 Average Gain MIMO 2

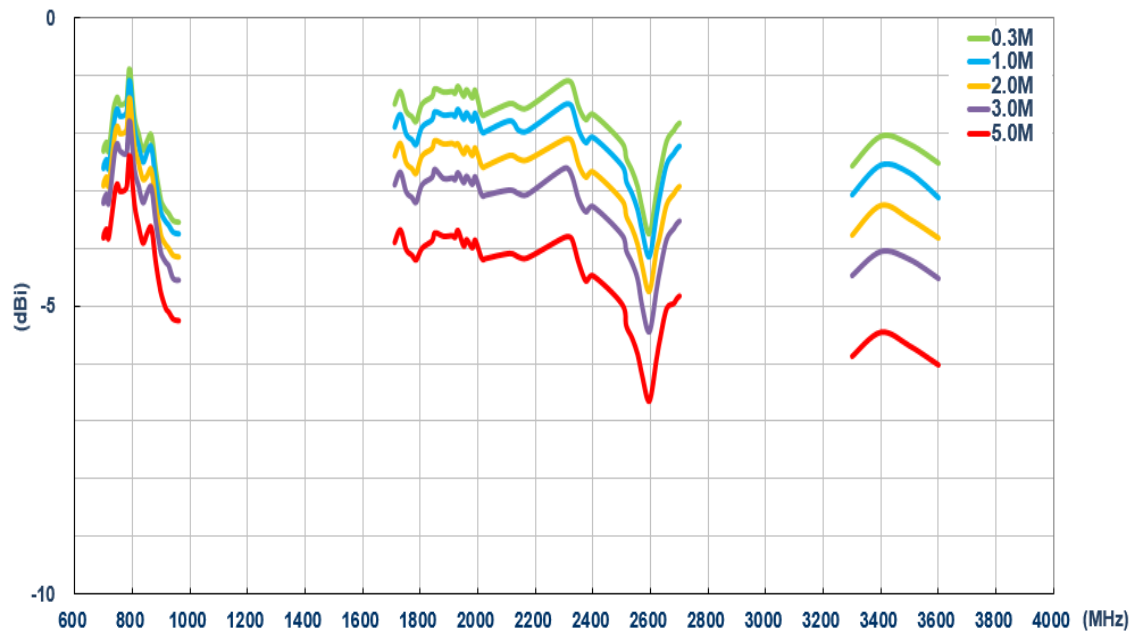

6.5.8 Peak Gain MIMO 1

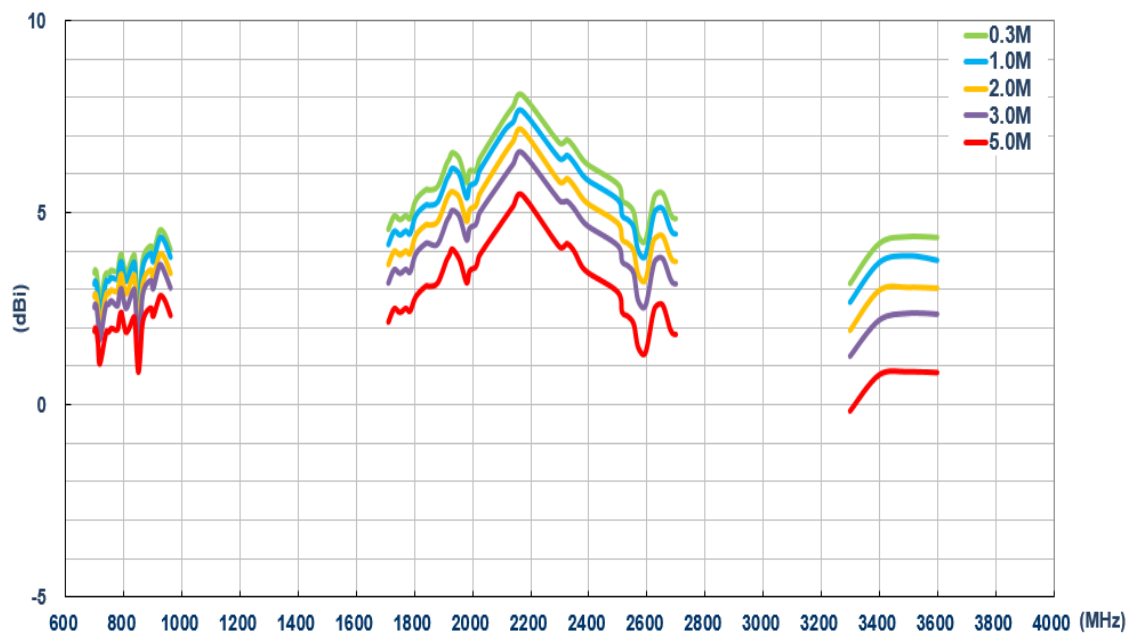

6.5.9 Peak Gain MIMO 2

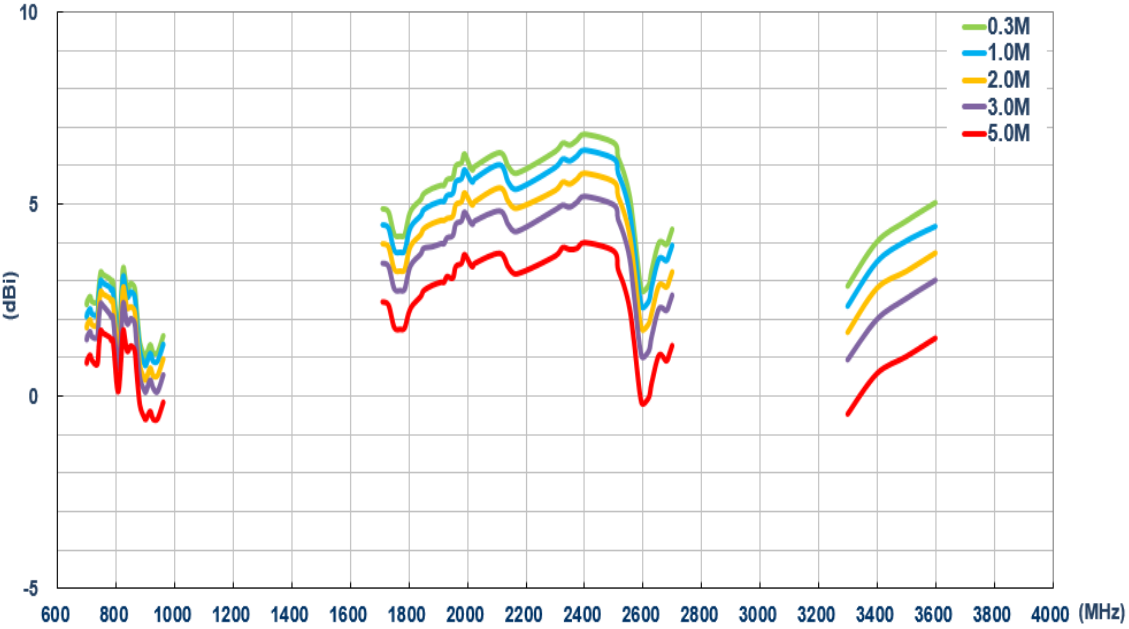

6.6 On the metal (LTE)

6.6.1 Return Loss LTE MIMO 1

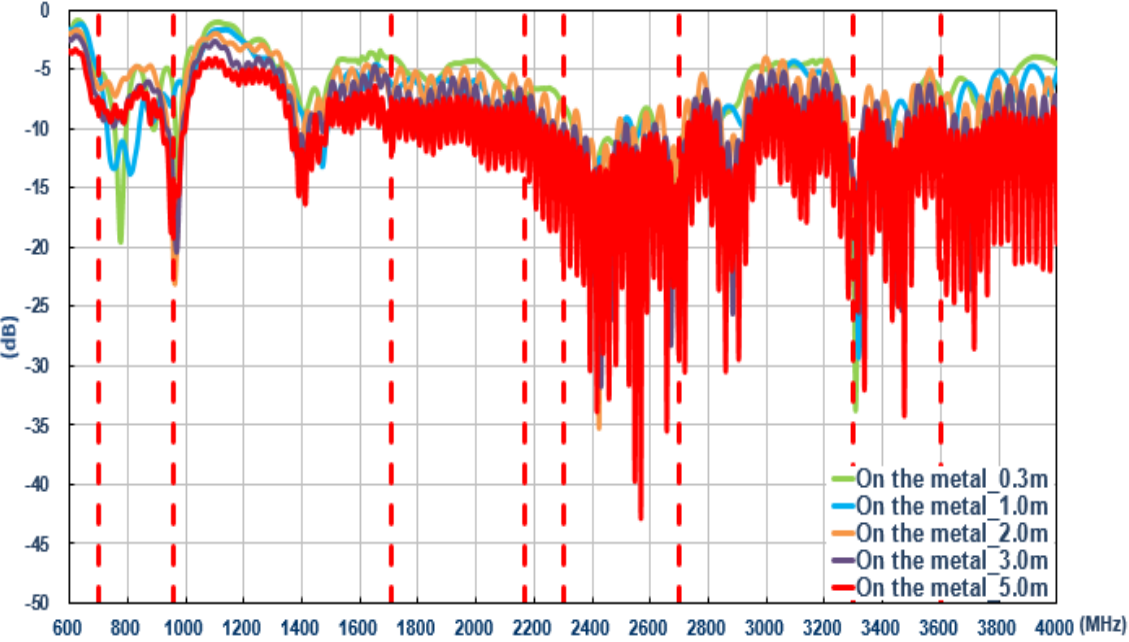

6.6.2 Return Loss LTE MIMO 2

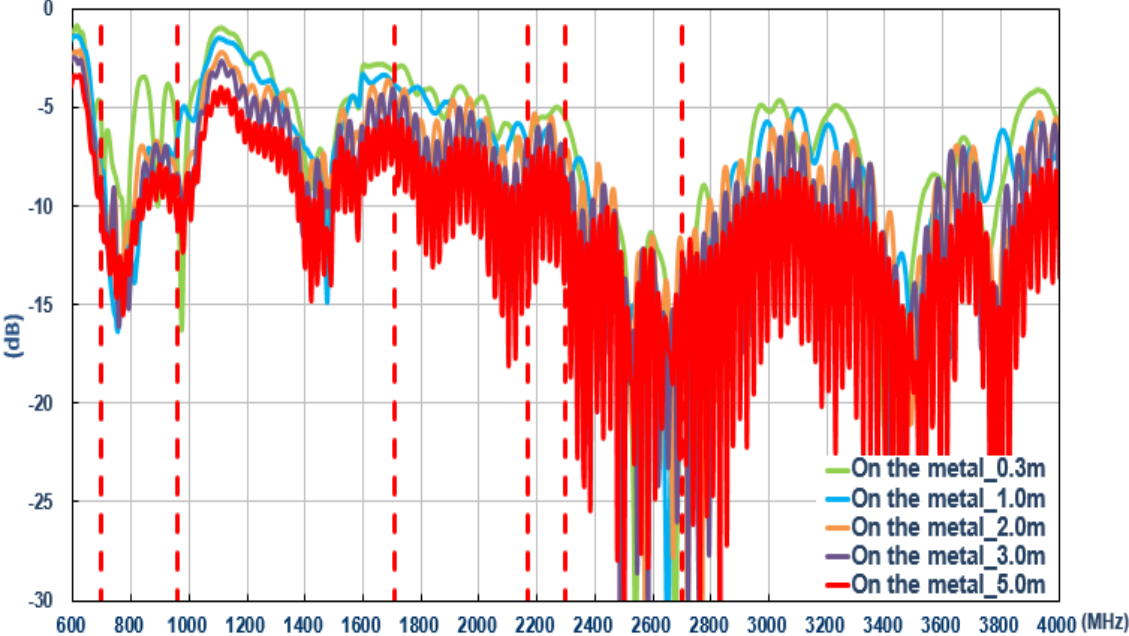

6.6.3 Isolation LTE antenna

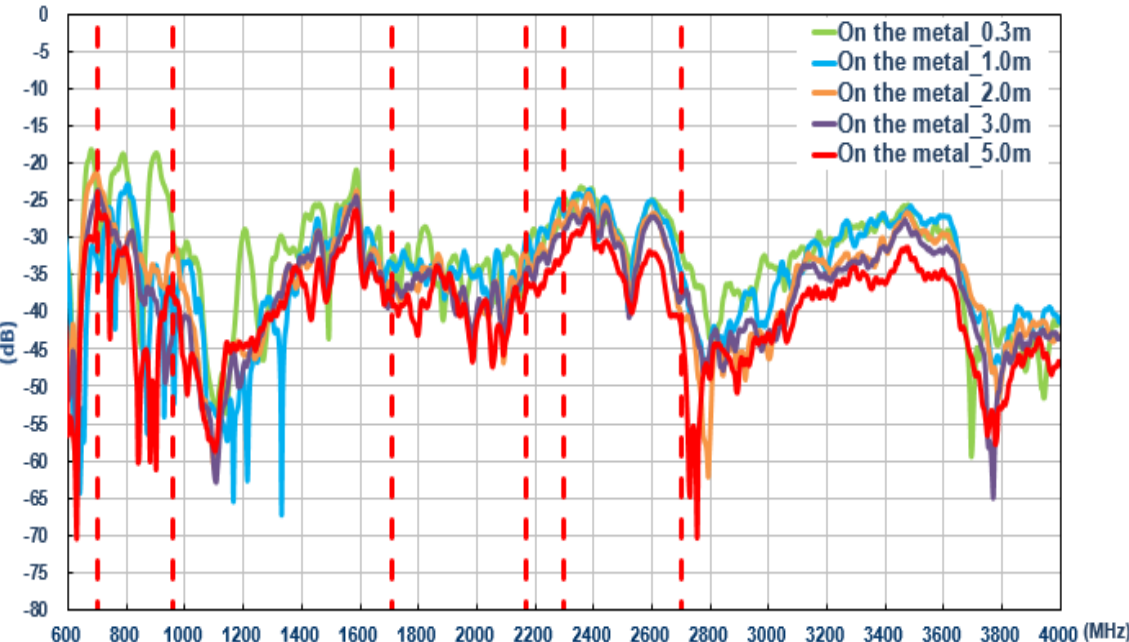

6.6.4 Efficiency LTE MIMO 1

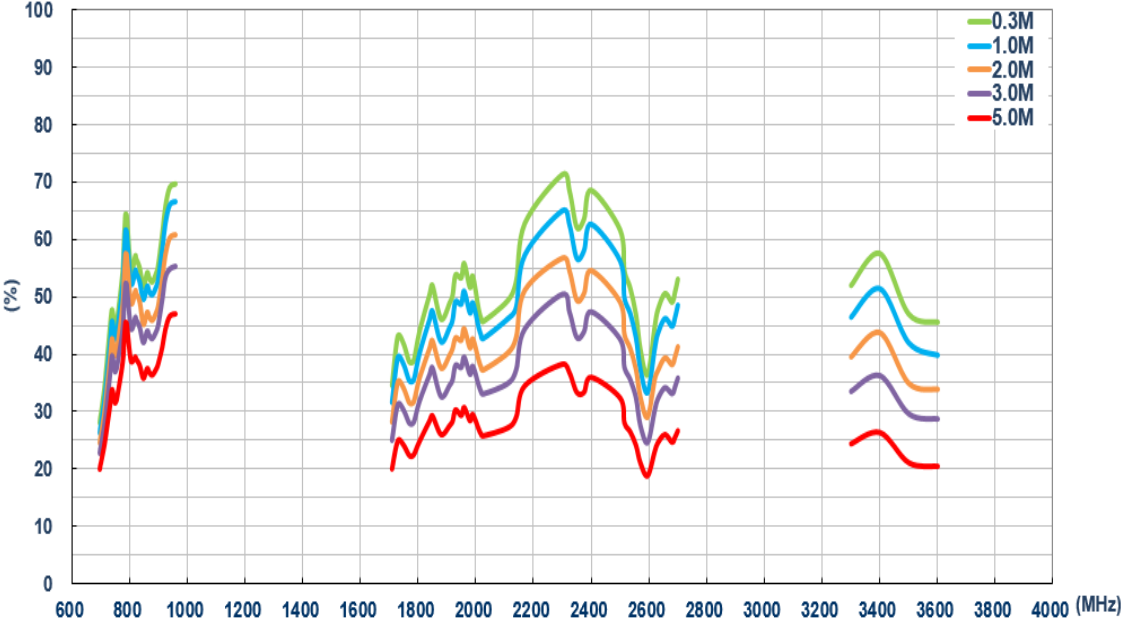

6.6.5 Efficiency LTE MIMO 2

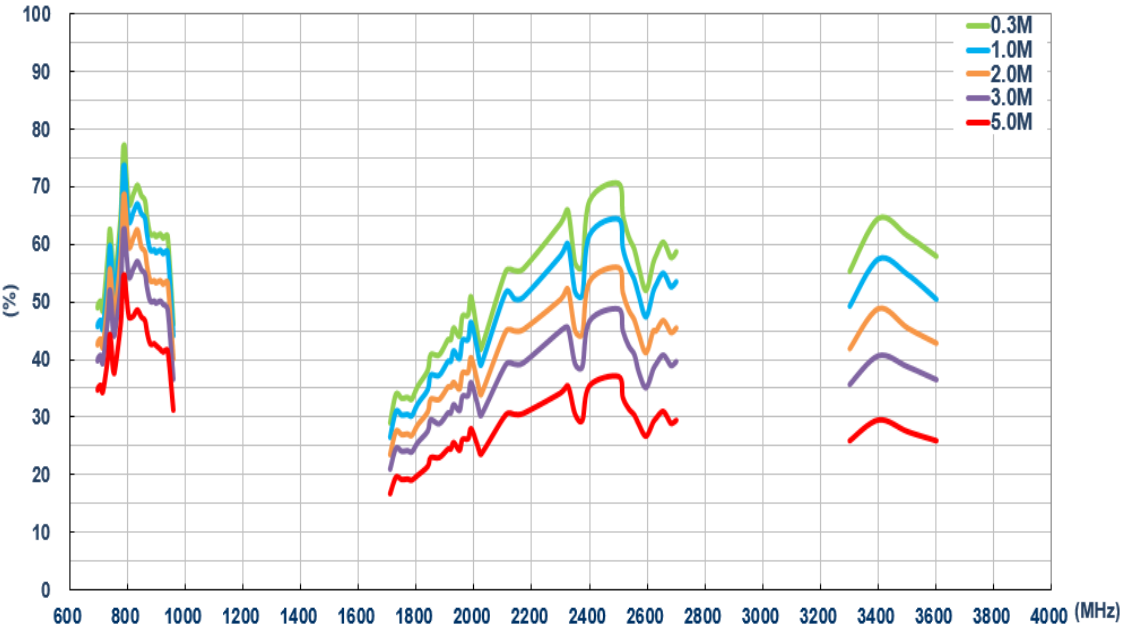

6.6.6 Average Gain LTE MIMO 1

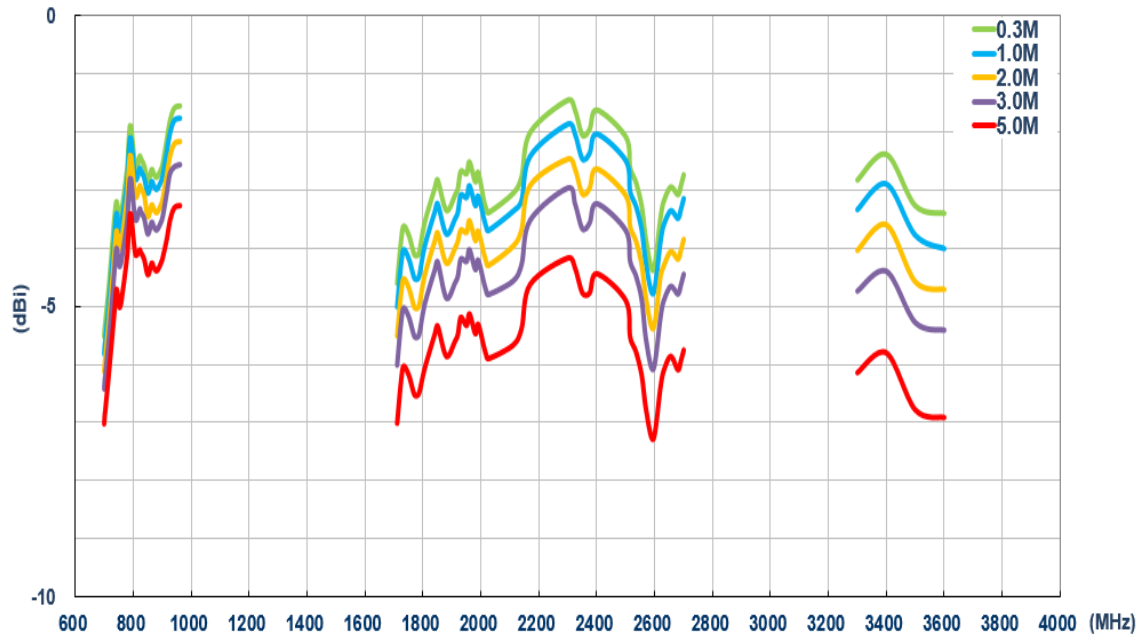

6.6.7 Average Gain LTE MIMO 2

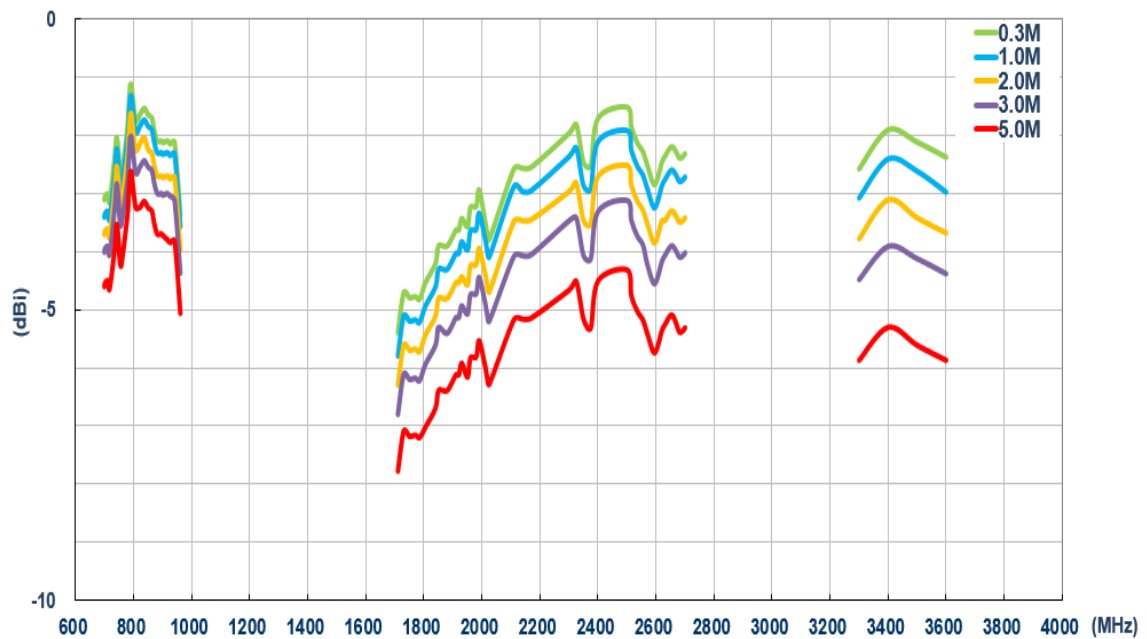

6.6.8 Peak Gain LTE MIMO 1

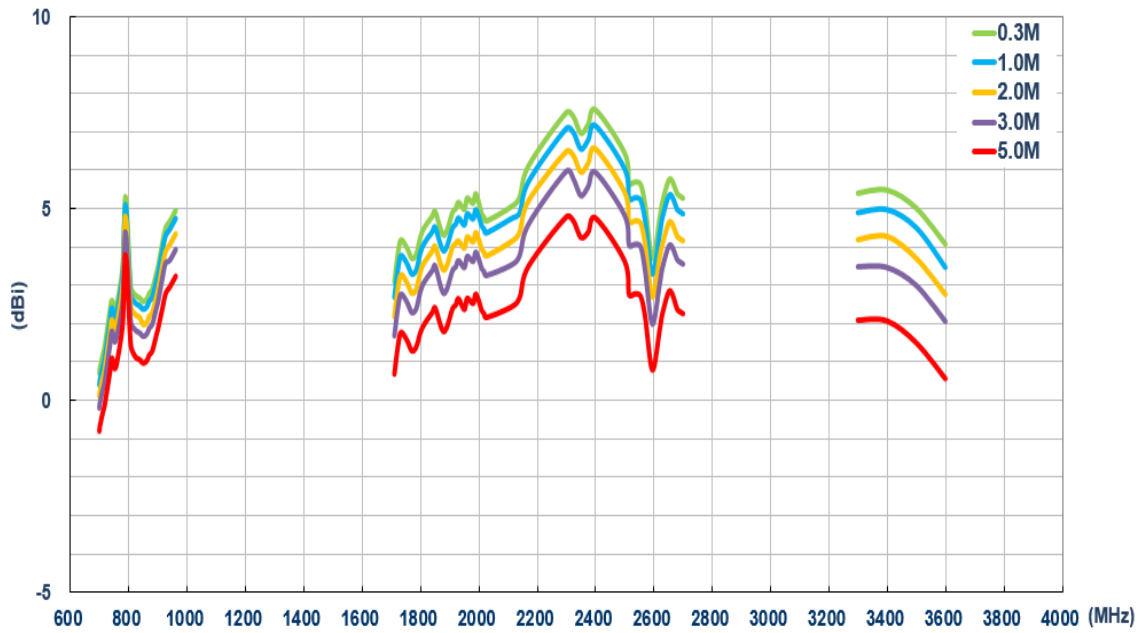

6.6.9 Peak Gain LTE MIMO 2

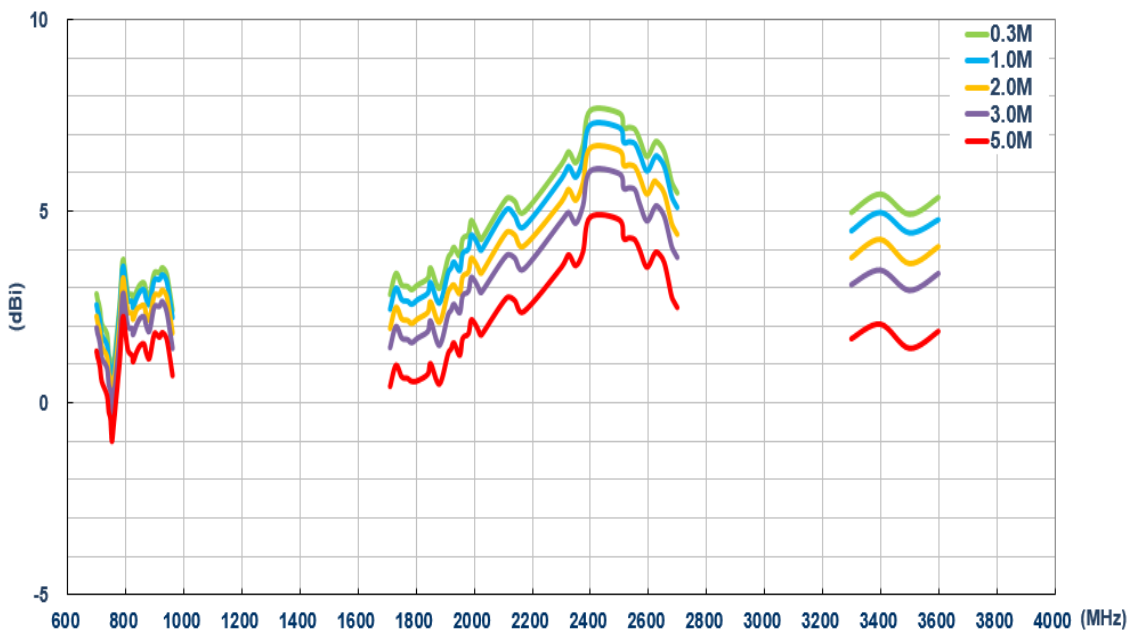

6.7 On the wall LTE

6.7.1 Return Loss LTE MIMO 1

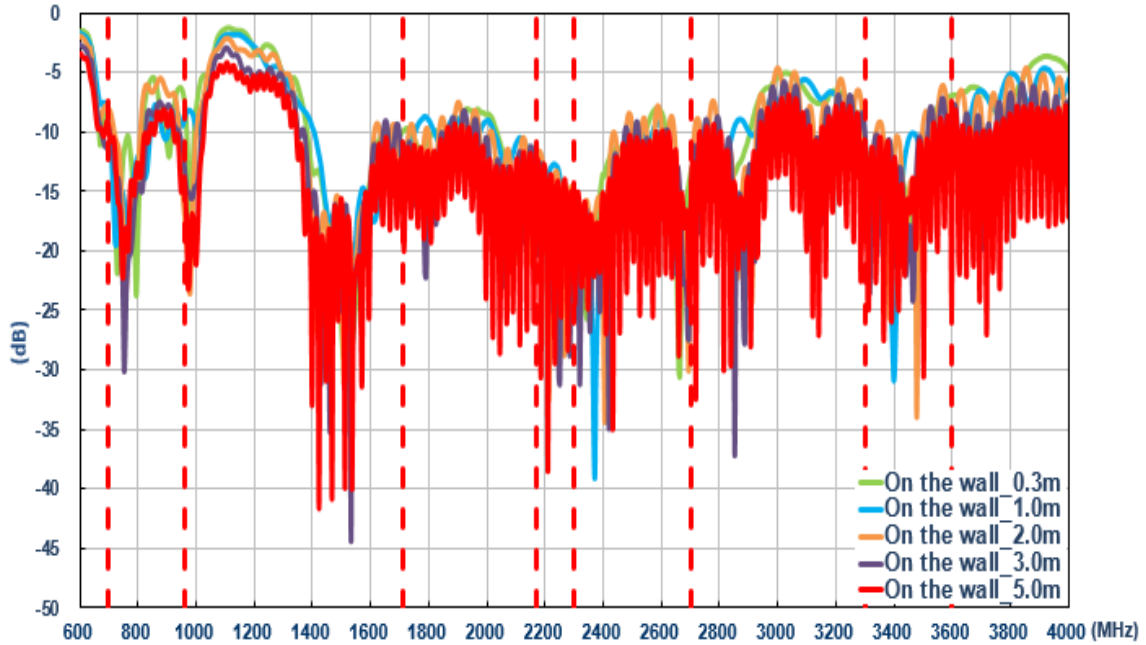

6.7.2 Return Loss LTE MIMO 2

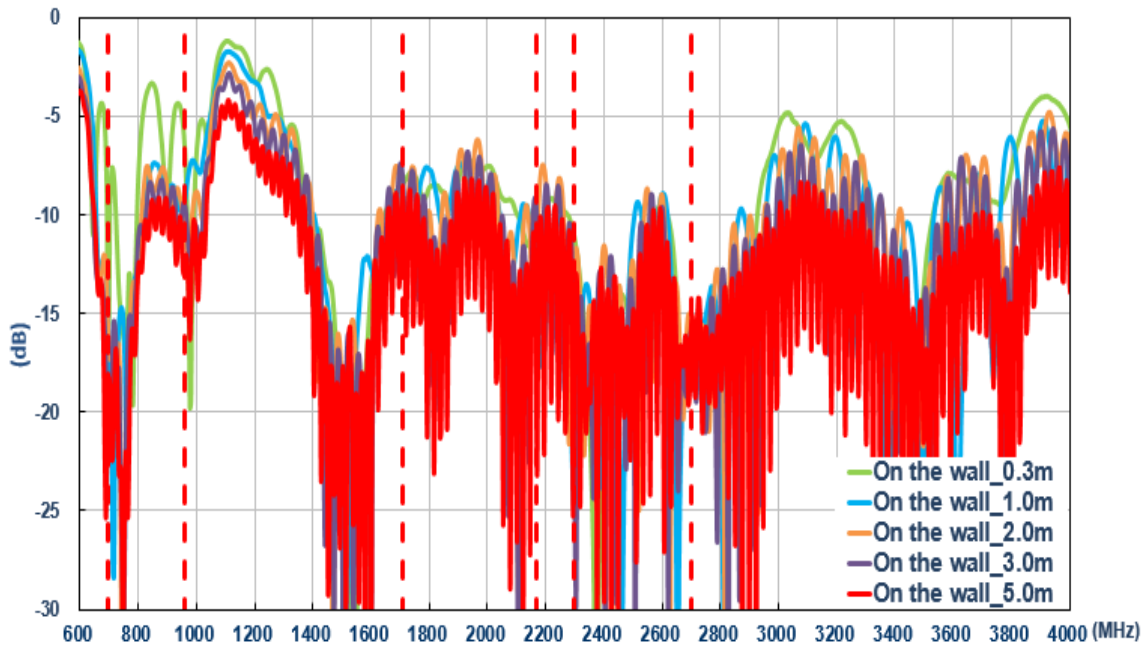

6.7.3 Isolation LTE antenna

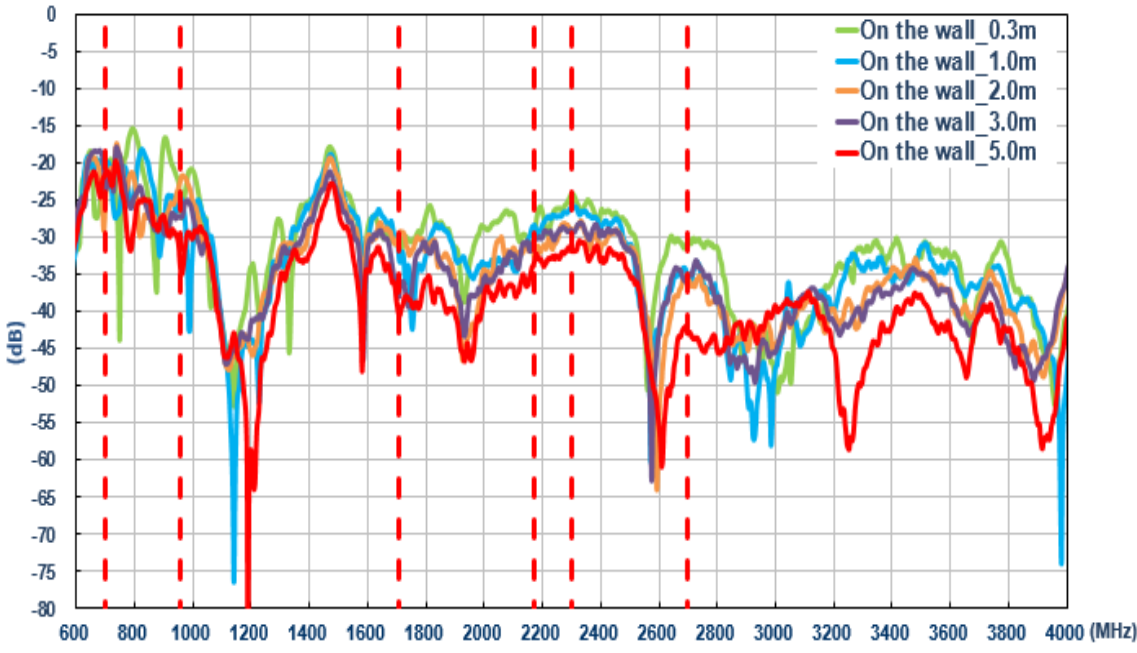

6.7.4 Efficiency LTE MIMO 1

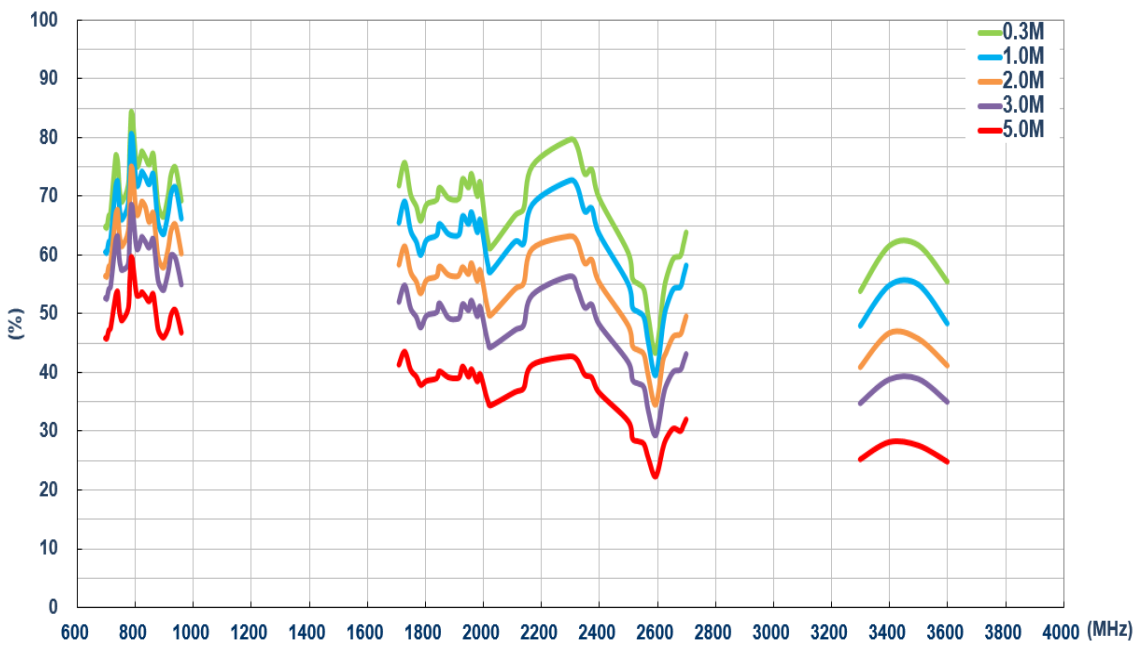

6.7.5 Efficiency LTE MIMO 2

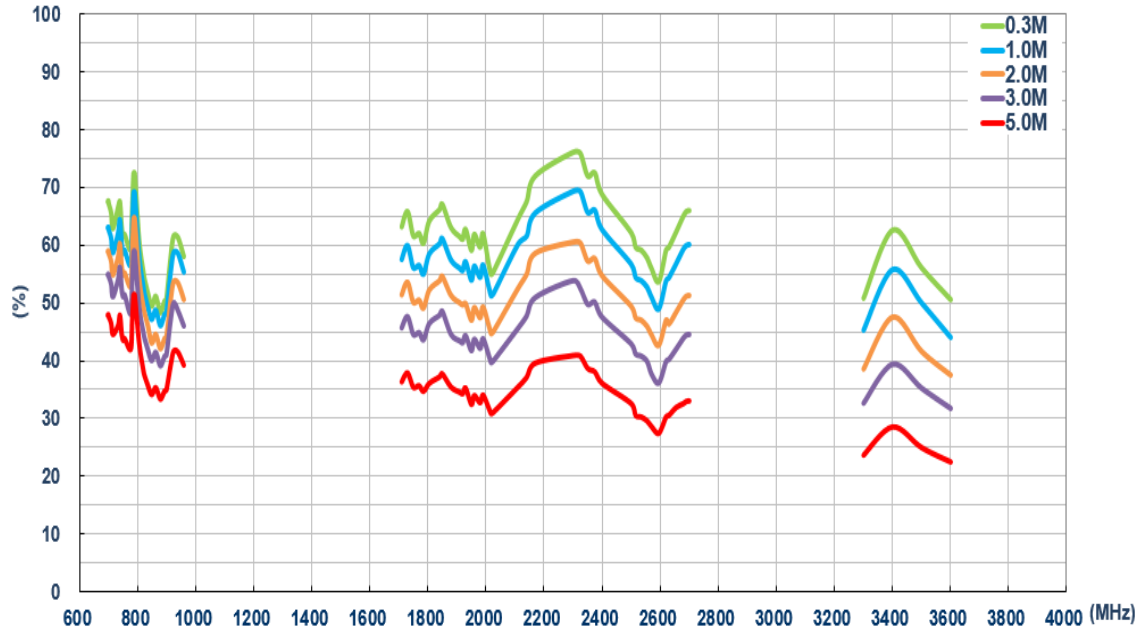

6.7.6 Average Gain LTE MIMO 1

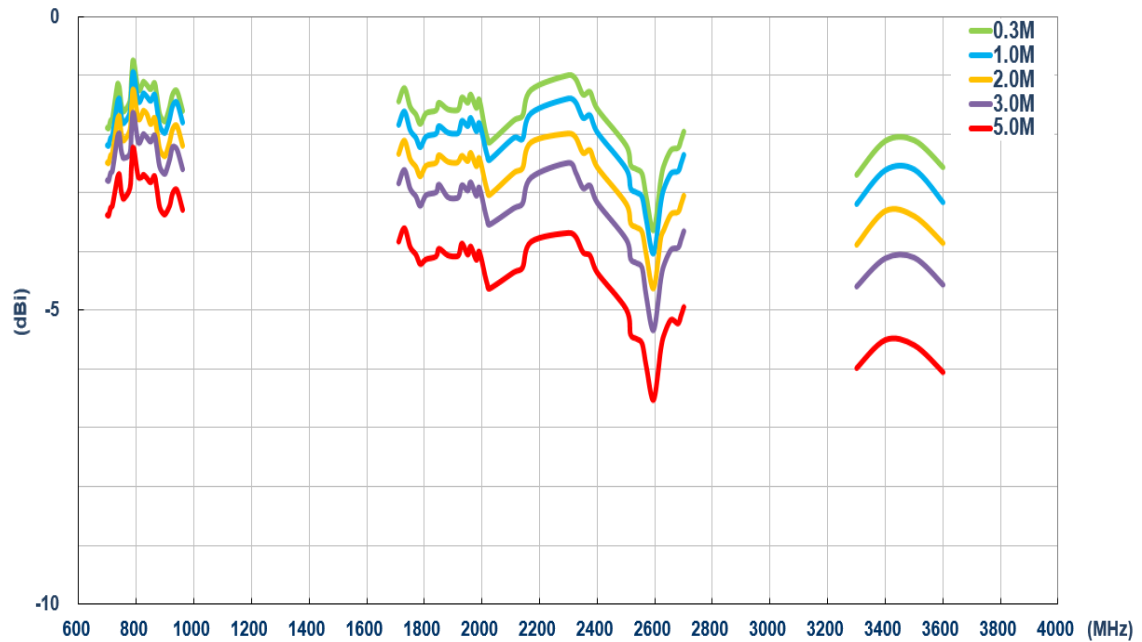

6.7.7 Average Gain LTE MIMO 2

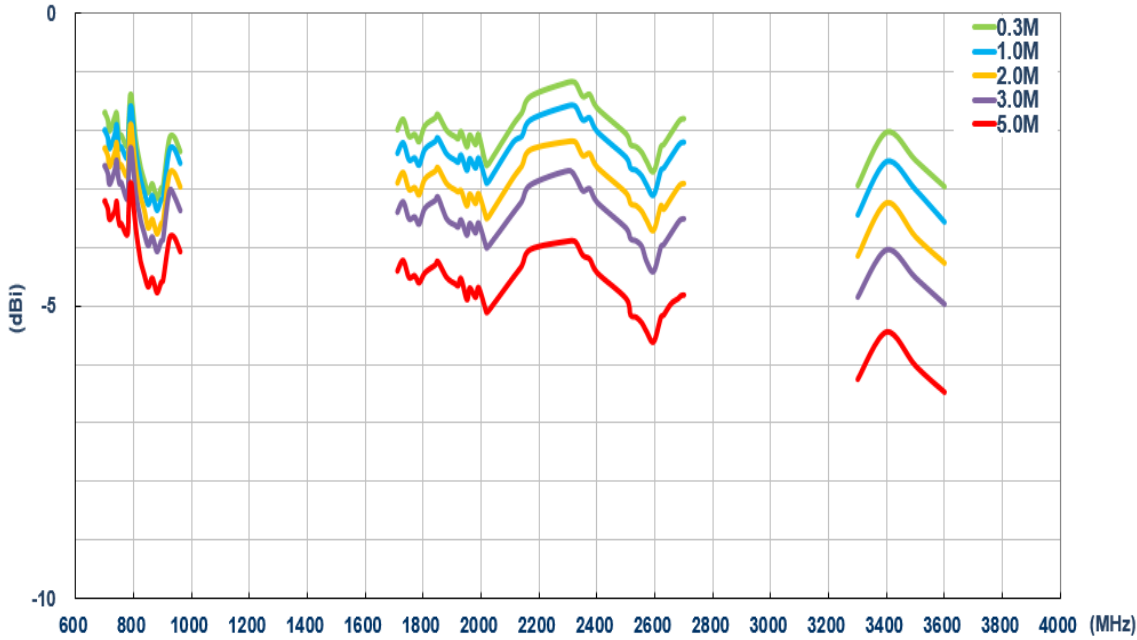

6.7.8 Peak Gain LTE MIMO 1

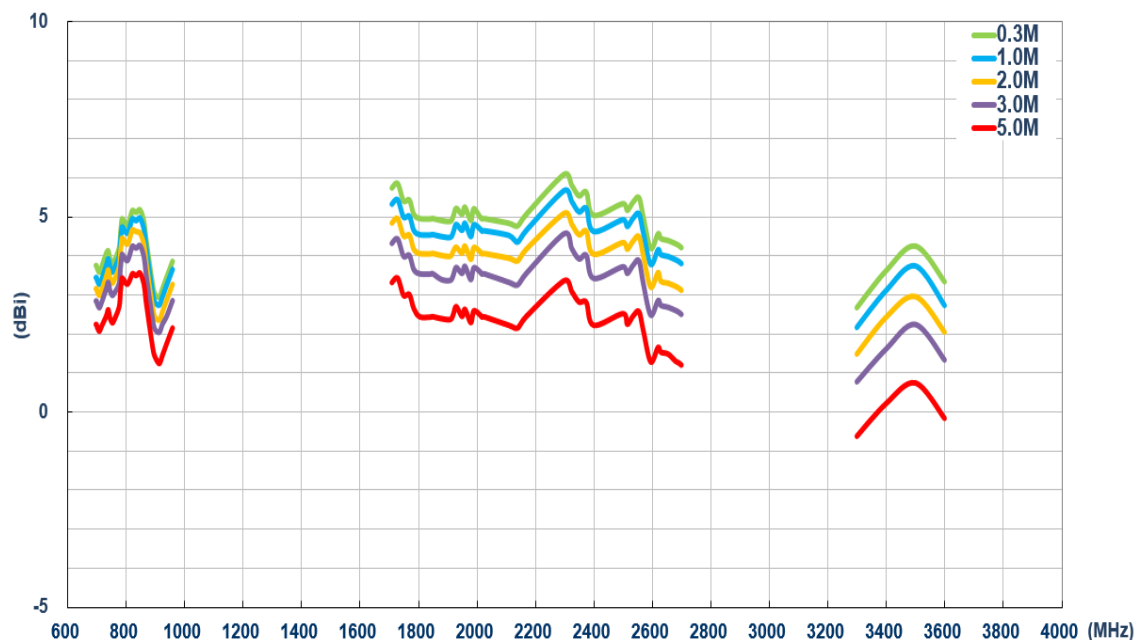

6.7.9 Peak Gain LTE MIMO 2

