



TAOGLAS®



Datasheet

Guardian 4-in-1 Wall Mount Antenna

Part No:
MA963.A.B1VW.002.wm

Description:

Guardian 4-in-1 Wall Mount Antenna 4*5G/4G MIMO Antenna

Features:

- Low-Profile Wall Mount Panel Antenna
- 4 * Wideband 5G/4G MIMO – 600MHz – 6GHz
- Covering Worldwide 5G/4G Bands
- Covering 5G NR Sub 6GHz Bands
- Covering CAT-M1 & NB-IoT Bands
- Includes 3G / 2G Fallback
- IP67 Rated Enclosure
- Cables: 3m TGC-200
- Connectors: SMA(M)ST
- Dimensions (including bracket): 146*134*26mm
- RoHS & REACH Compliant

1. Introduction	3
2. Specifications	4
3. Antenna Characteristics	7
4. Radiation Patterns	11
5. Mechanical Drawing	26
6. Installation Instructions	27
7. Packaging	30

Changelog

Taoglas makes no warranties based on the accuracy or completeness of the contents of this document and reserves the right to make changes to specifications and product descriptions at any time without notice. Taoglas reserves all rights to this document and the information contained herein.

Reproduction, use or disclosure to third parties without express permission is strictly prohibited.



1. Introduction



The Taoglas MA963.A.BIVW.002.wm Guardian is a next-generation 4-in-1 combination wall mount antenna. It is the world-first panel antenna designed for IoT Gateway and Router devices with multiple wireless technologies. This antenna delivers powerful MIMO antenna technology for LTE and Sub-6GHz 5G bands covering 600MHz - 6GHz. This antenna is designed for 5G/4G bands worldwide (including 3G & 2G fallback) for access points, terminals, and routers. CAT-M1 and NB-IoT and the recently introduced 600MHz Extended 5G/4G Band 71 are also covered. This wide bandwidth enables designers to cover a wide range of technologies by installing a single antenna installation. It is a heavy-duty, fully IP67 waterproof external M2M antenna available in both wall and adhesive mount versions, see the [MA963.A.BIVW.002](#) for the adhesive version.

Typical use cases include

- IoT Gateway and Routers
- HD Video Streaming
- Transportation z

5G/4G wireless applications demand high-speed data uplink and downlink. High efficiency and high gain MIMO antennas are necessary to achieve the required signal to noise ratio and throughput required to solve these challenges. Taoglas also takes care to have high isolation among these antennas to prevent self-interference. Low loss cables used to keep efficiency high over long cable lengths. The antenna can be mounted internally or externally on a vehicle. The MA963 comes with 3m, low loss TGC-200 coaxial cables as standard. Customized cables and connector versions are also available. Contact your regional Taoglas customer support for more information on how to integrate the MA963 or sales support.

2. Specifications

5G/4G MIMO Antennas											
Frequency (MHz)		5G NR Band 71	LTE700	GSM850/900	5G NR Band 74, 75, 76	DCS	PCS	UMTS1	LTE2600	5G NR Band 77, 78, 79	LTE5200/WiFi5800
		617 ~698	698 ~806	824 ~960	1427 ~1518	1710 ~1880	1850 ~1990	1920 ~2170	2490 ~2690	3300 ~5000	5150 ~5925
Efficiency (%)											
MIMO 1	3m	33.03	42.85	54.27	56.48	62.58	57.98	55.61	57.04	43.44	32.23
MIMO 2	3m	39.89	55.17	56.75	45.73	48.59	43.62	41.21	40.46	37.88	32.60
MIMO 3	3m	46.38	51.55	55.06	43.81	46.39	45.05	44.82	51.22	42.86	34.02
MIMO 4	3m	32.78	34.87	35.74	49.14	61.44	58.48	54.84	53.27	42.94	28.30
Average Gain (dB)											
MIMO 1	3m	-4.81	-3.68	-2.65	-2.48	-2.04	-2.37	-2.55	-2.44	-3.62	-4.92
MIMO 2	3m	-3.99	-2.58	-2.46	-3.40	-3.13	-3.60	-3.85	-3.93	-4.22	-4.87
MIMO 3	3m	-3.34	-2.88	-2.59	-3.58	-3.34	-3.46	-3.49	-2.91	-3.68	-4.68
MIMO 4	3m	-4.84	-4.58	-4.47	-3.09	-2.12	-2.33	-2.61	-2.74	-3.67	-5.48
Peak Gain (dBi)											
MIMO 1	3m	1.42	1.28	3.56	3.24	3.55	3.21	3.21	3.11	3.06	3.84
MIMO 2	3m	1.59	2.76	3.38	3.42	3.06	3.06	4.08	4.76	2.07	1.92
MIMO 3	3m	1.93	2.26	2.86	3.12	4.71	4.71	4.32	3.89	2.88	2.39
MIMO 4	3m	1.08	0.76	3.02	3.62	3.11	3.11	2.92	2.77	2.97	2.46
Impedance		50Ω									
Polarization		Linear									
Radiation Pattern		Omni									
Max. input power		2 W									

Mechanical	
Height	26mm
Planner Dimension	146*134 mm
Casing	ASA
Cable	TGC-200 3000 mm
Connector	SMA(M)
Weight	850g
Environmental	
Protection	IP67
Temperature Range	-40°C to 85°C
Humidity	Non-condensing 65°C 95% RH

5G/4G Bands			
Band Number	5G NR / FR1 / LTE / LTE-Advanced / WCDMA / HSPA / HSPA+ / TD-SCDMA		
	Uplink	Downlink	Covered
1	UL: 1920 to 1980	DL: 2110 to 2170	✓
2	UL: 1850 to 1910	DL: 1930 to 1990	✓
3	UL: 1710 to 1785	DL: 1805 to 1880	✓
4	UL: 1710 to 1755	DL: 2110 to 2155	✓
5	UL: 824 to 849	DL: 869 to 894	✓
7	UL: 2500 to 2570	DL: 2620 to 2690	✓
8	UL: 880 to 915	DL: 925 to 960	✓
9	UL: 1749.9 to 1784.9	DL: 1844.9 to 1879.9	✓
11	UL: 1427.9 to 1447.9	DL: 1475.9 to 1495.9	✓
12	UL: 699 to 716	DL: 729 to 746	✓
13	UL: 777 to 787	DL: 746 to 756	✓
14	UL: 788 to 798	DL: 758 to 768	✓
17	UL: 704 to 716	DL: 734 to 746	✓
18	UL: 815 to 830	DL: 860 to 875	✓
19	UL: 830 to 845	DL: 875 to 890	✓
20	UL: 832 to 862	DL: 791 to 821	✓
21	UL: 1447.9 to 1462.9	DL: 1495.9 to 1510.9	✓
22	UL: 3410 to 3490	DL: 3510 to 3590	✓
23	UL: 2000 to 2020	DL: 2180 to 2200	✓
24	UL: 1625.5 to 1660.5	DL: 1525 to 1559	✓
25	UL: 1850 to 1915	DL: 1930 to 1995	✓
26	UL: 814 to 849	DL: 859 to 894	✓
27	UL: 807 to 824	DL: 852 to 869	✓
28	UL: 703 to 748	DL: 758 to 803	✓
29	UL: -	DL: 717 to 728	✓
30	UL: 2305 to 2315	DL: 2350 to 2360	✓
31	UL: 452.5 to 457.5	DL: 462.5 to 467.5	✗
32	UL: -	DL: 1452 - 1496	✓
35		1850 to 1910	✓
38		2570 to 2620	✓
39		1880 to 1920	✓
40		2300 to 2400	✓
41		2496 to 2690	✓
42		3400 to 3600	✓
43		3600 to 3800	✓
48		3550 to 3700	✓
66	UL: 1710-1780	DL: 2110-2200	✓
71		617 to 698	✓
74/75/76		1427 to 1518	✓
78		3300 to 3800	✓
79		4400 to 5000	✓
126		410 to 430	✗

*Covered bands represent greater than 20% efficiency

3. Antenna Characteristics

3.1 Test Setup – Free Space

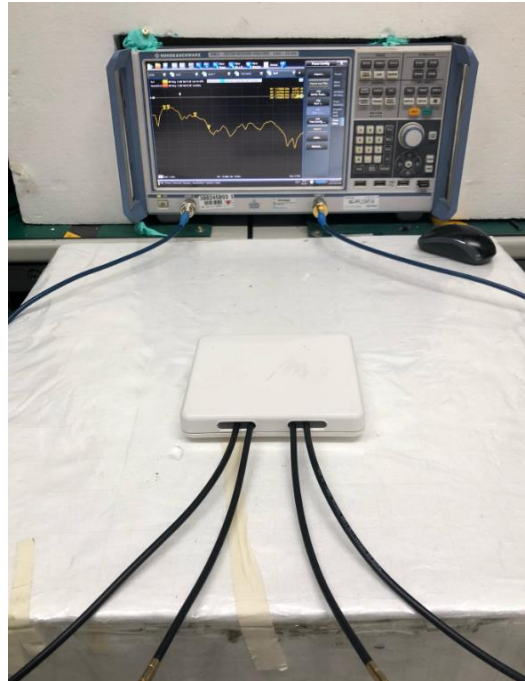

3.2 Return Loss

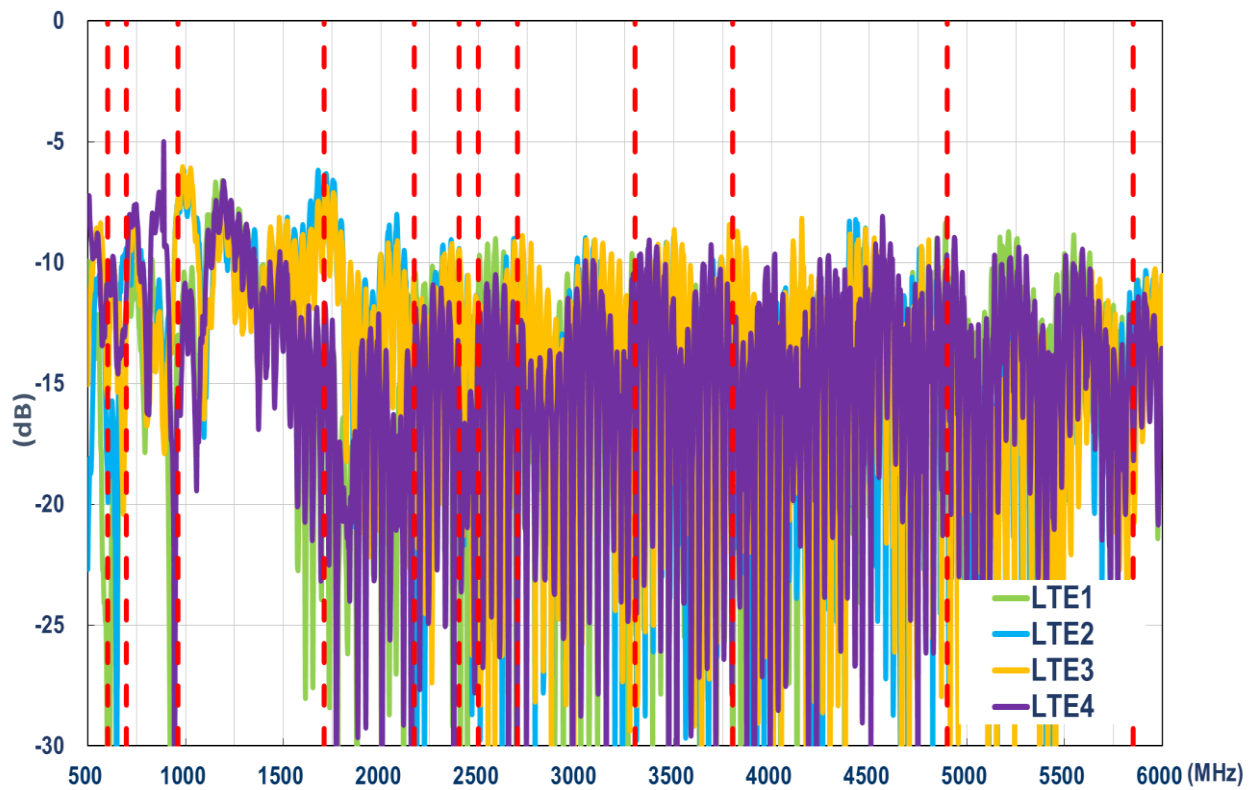

3.3 Isolation

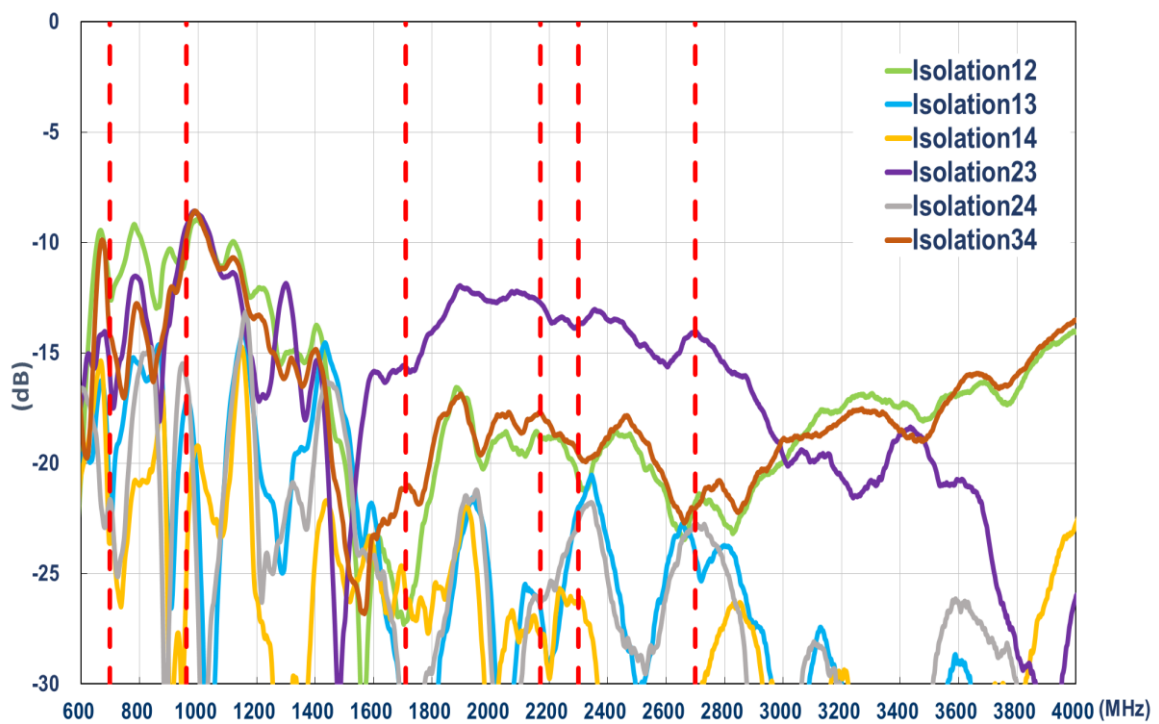

3.4 Efficiency

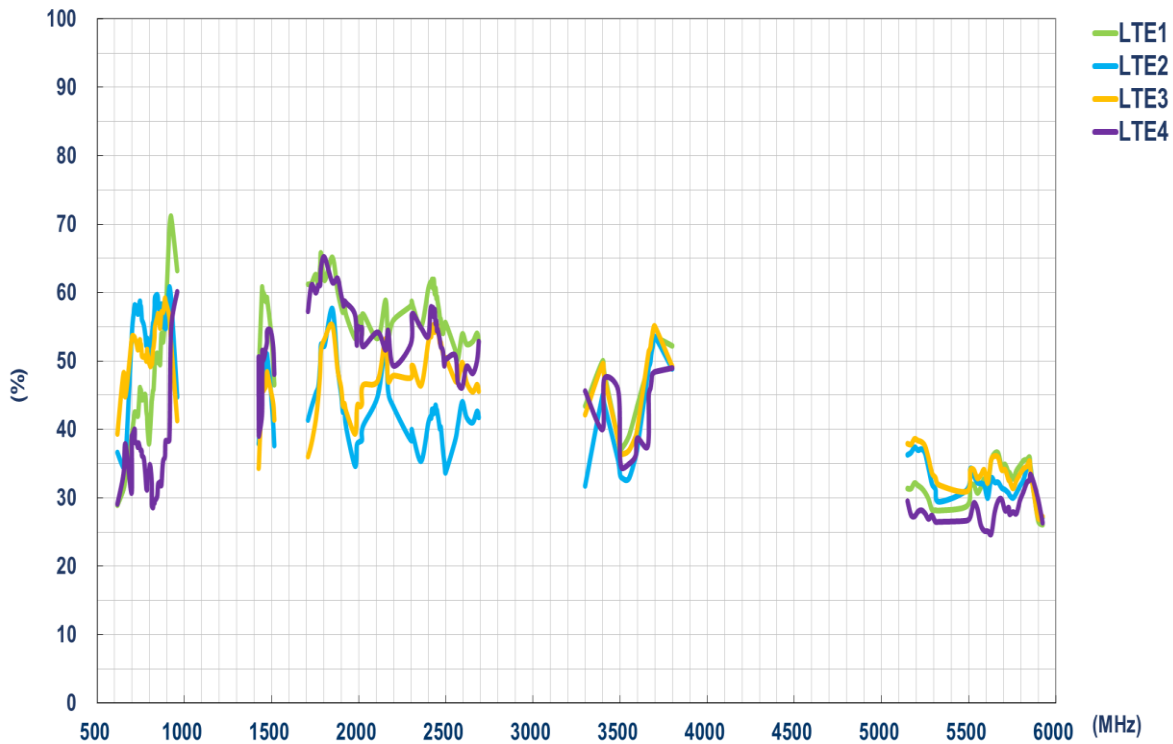

3.5 Average gain

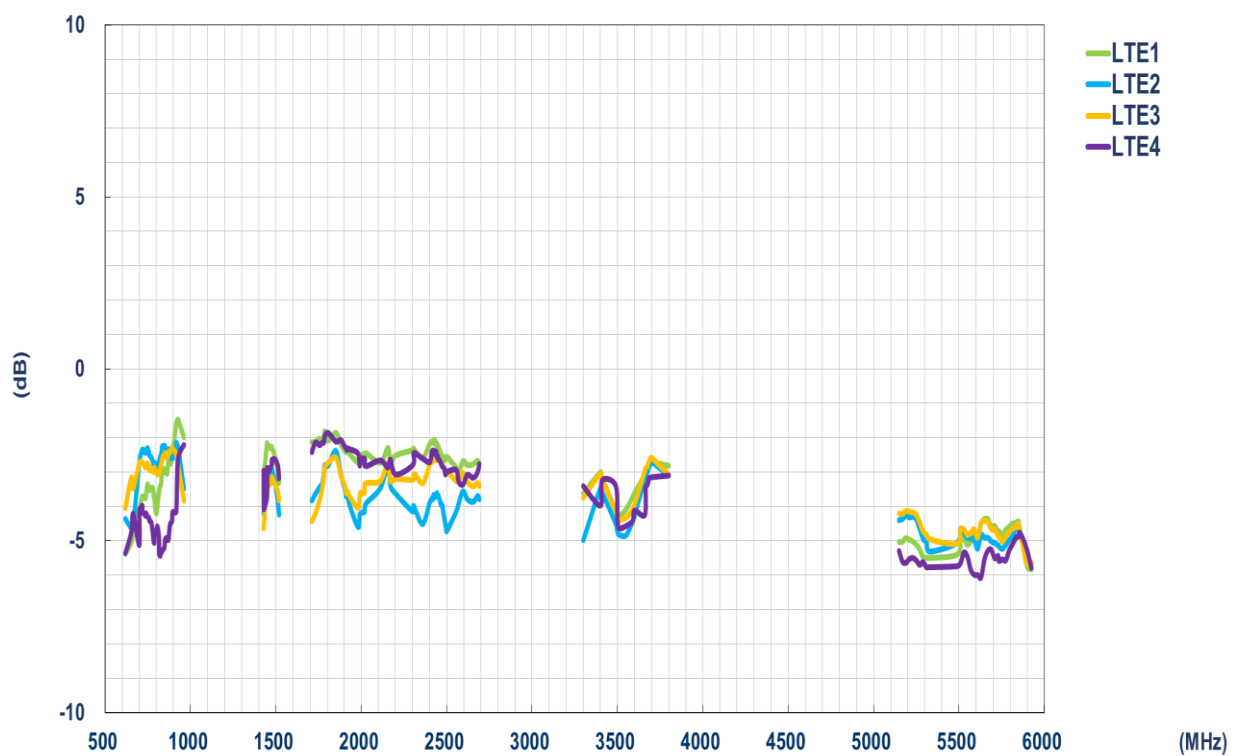

3.6 Peak gain

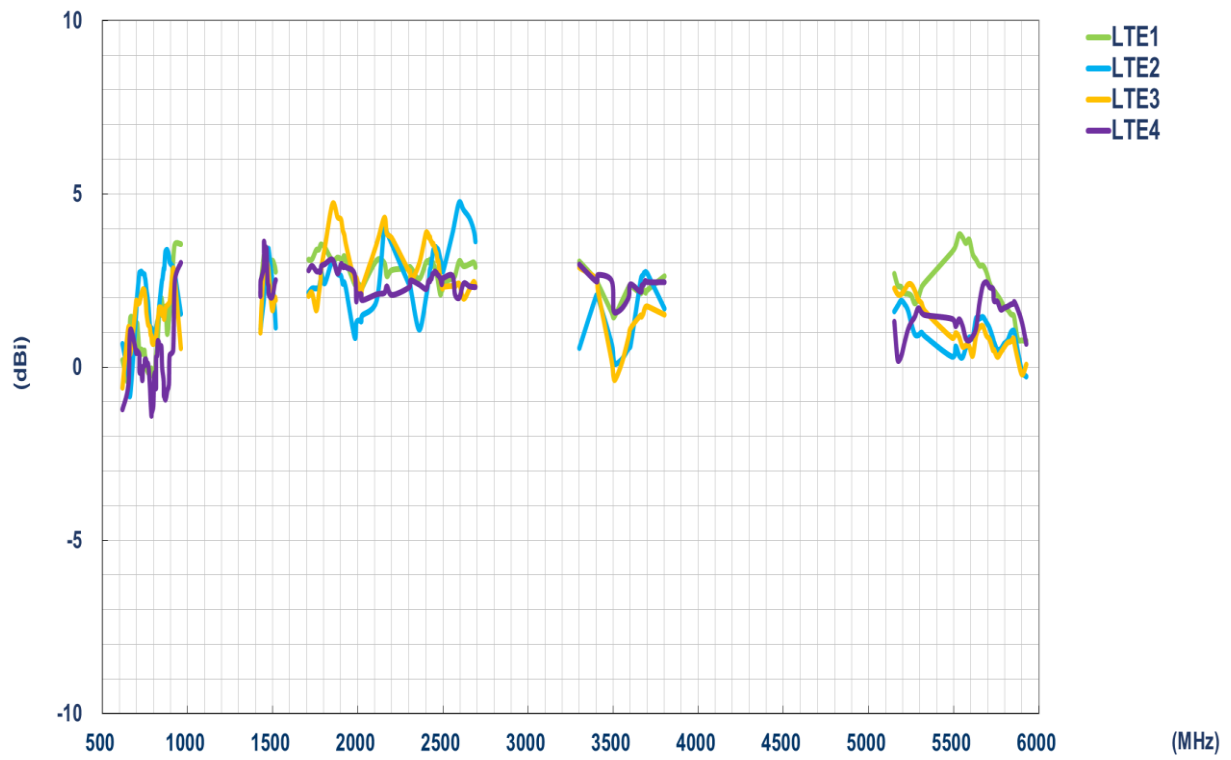

4. Radiation Patterns

4.1 Test Setup – Free Space



4.2 2D Radiation Patterns

4.2.1 5G/4G MIMO1

XY Plane

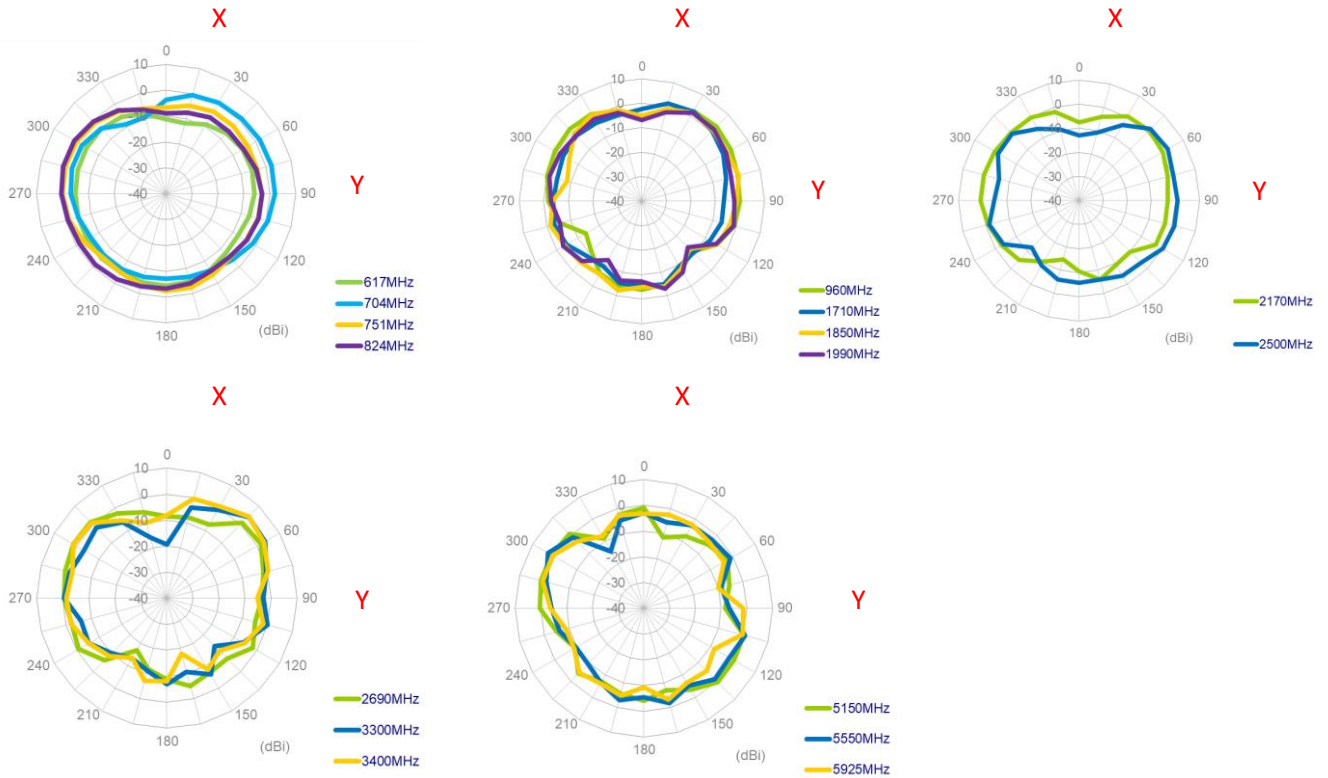

XZ Plane

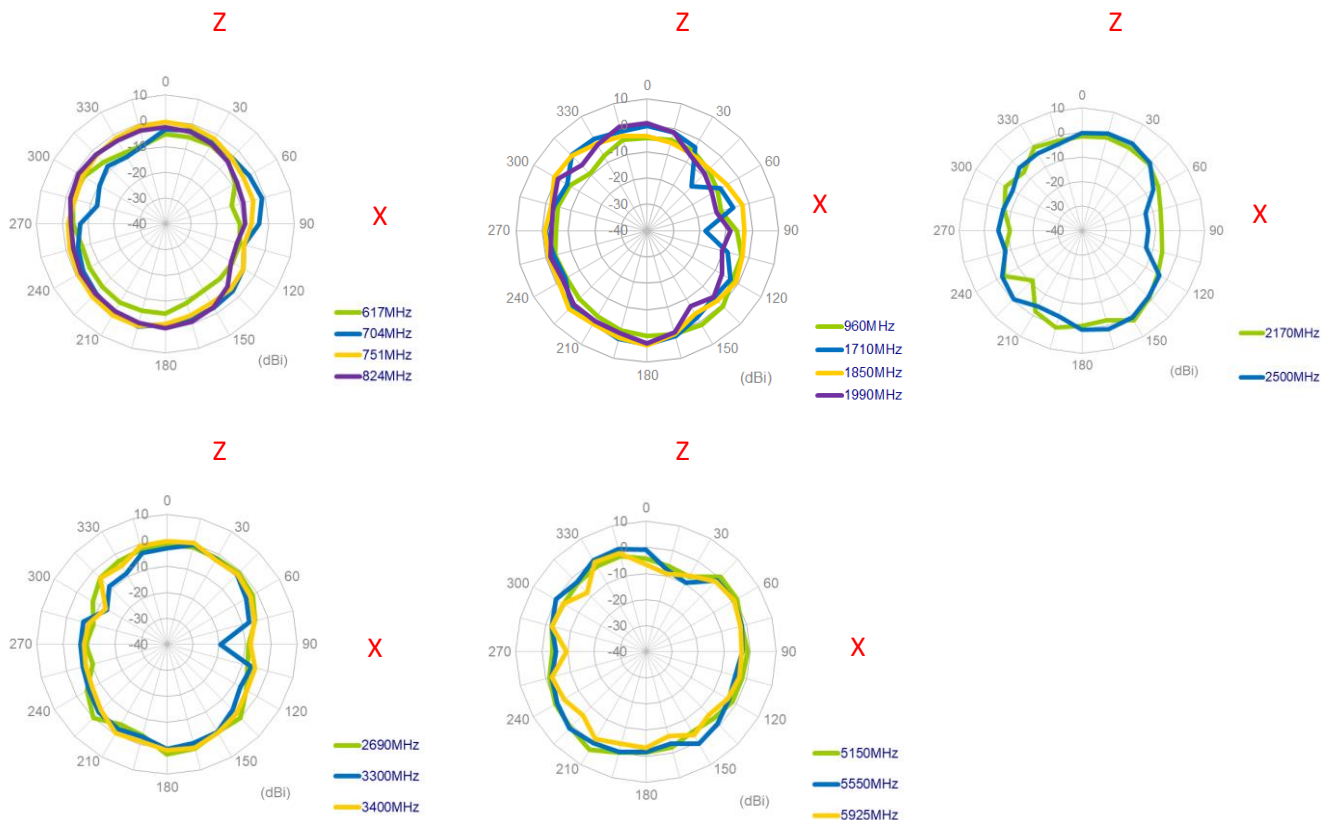

YZ Plane

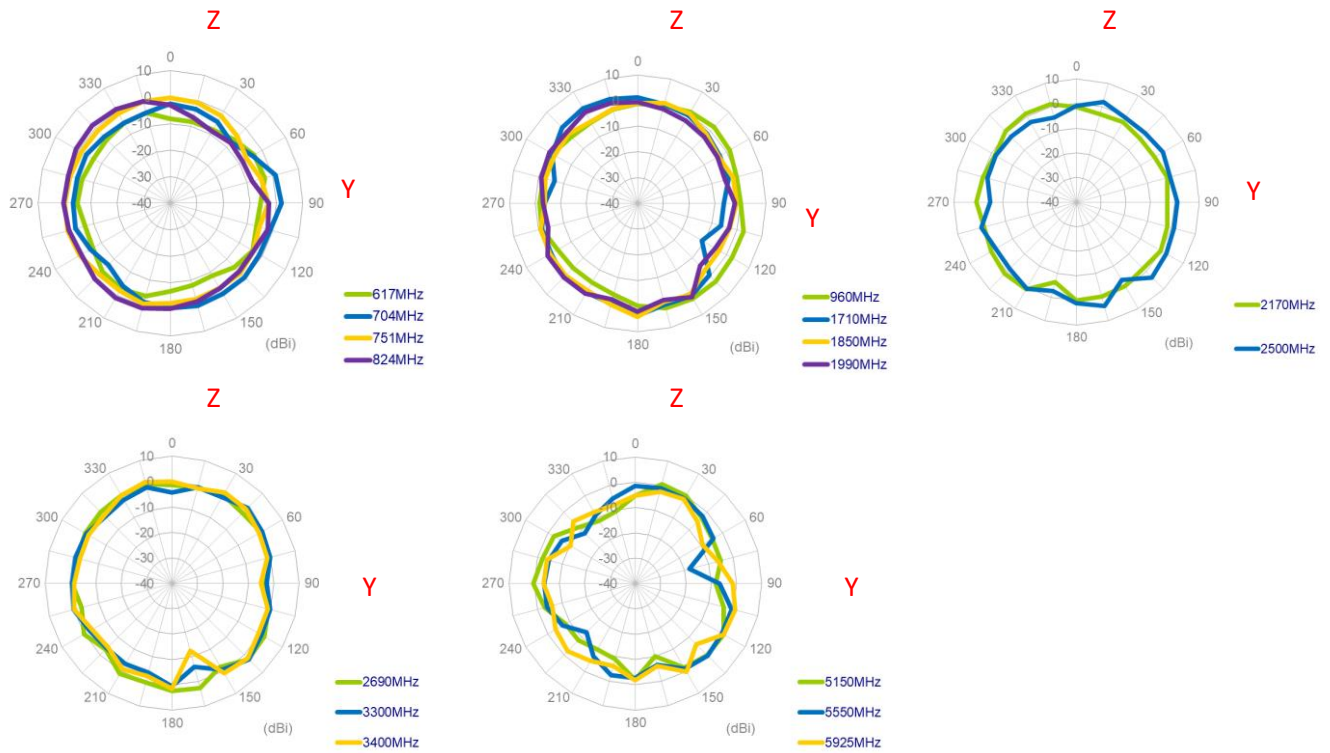

4.2.2 5G/4G MIMO2

XY Plane

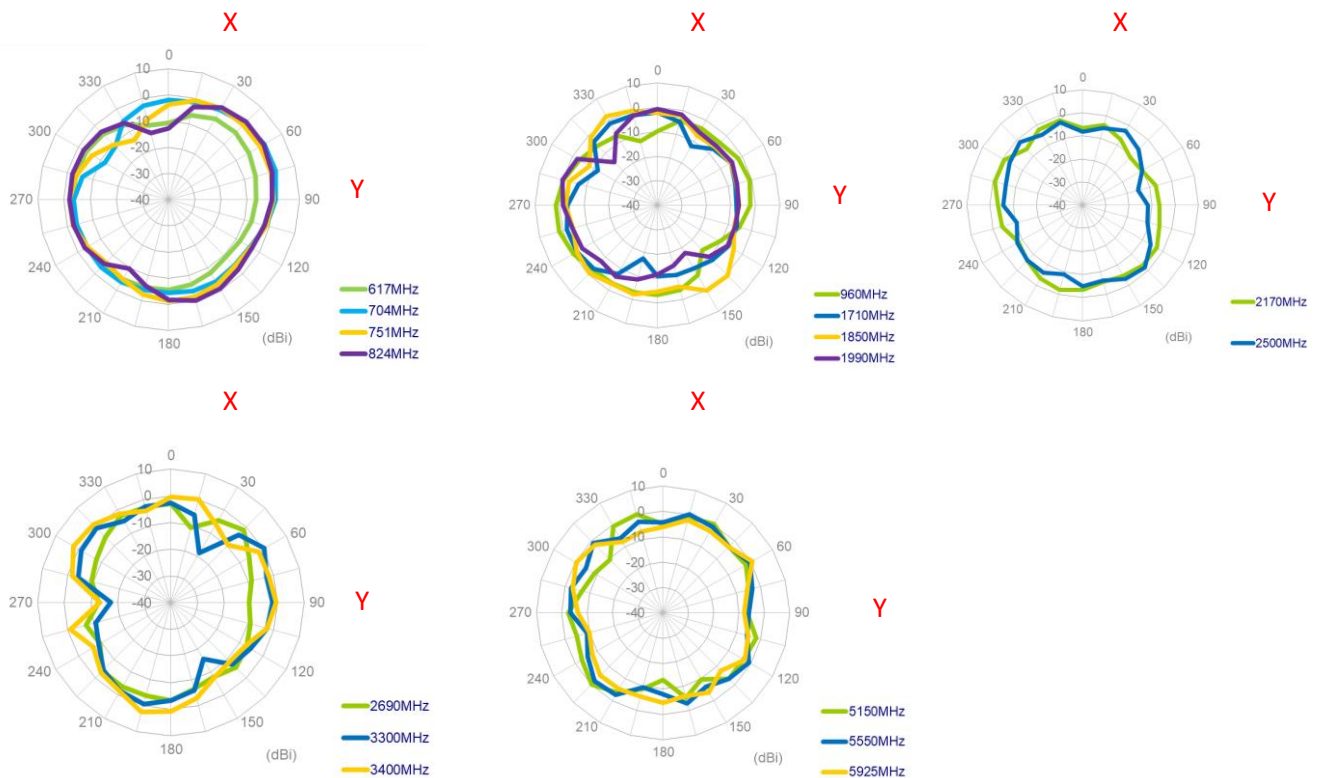

XZ Plane

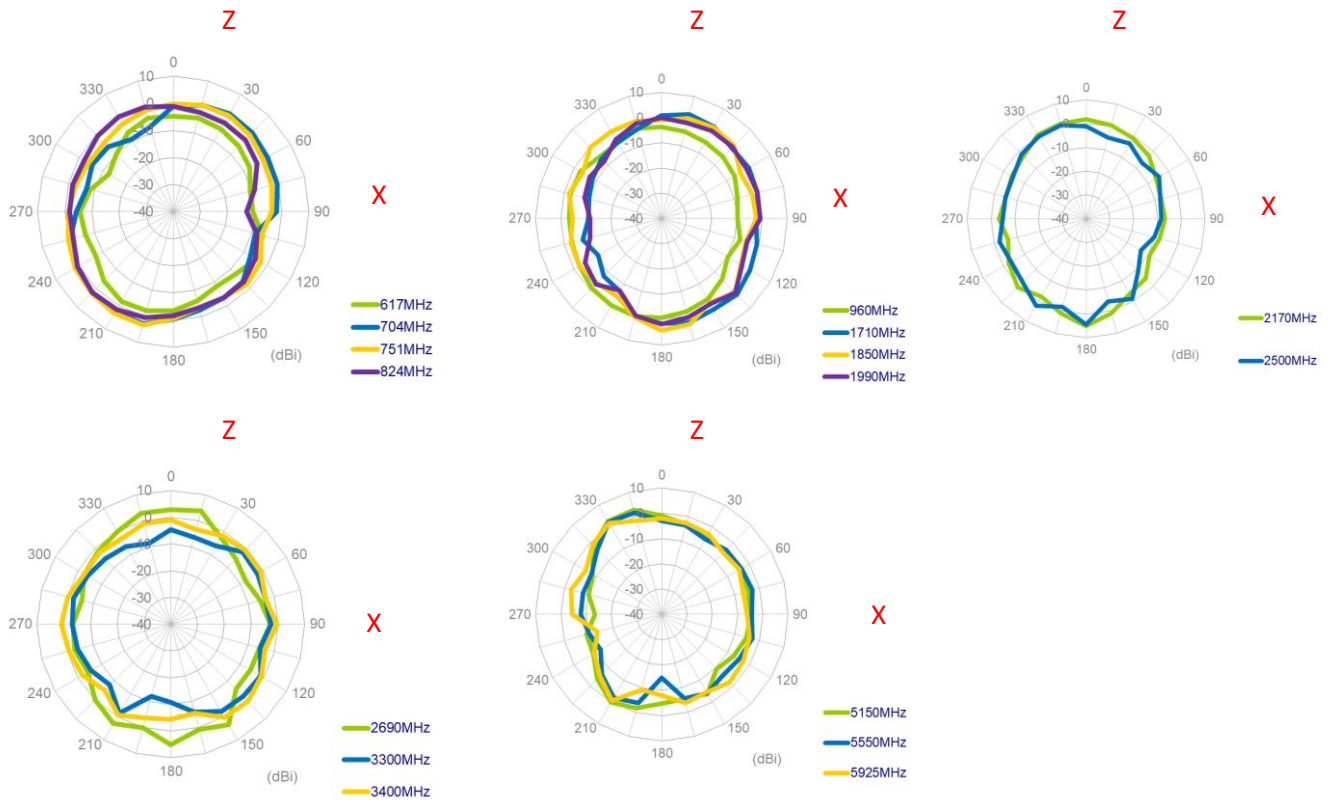

YZ Plane

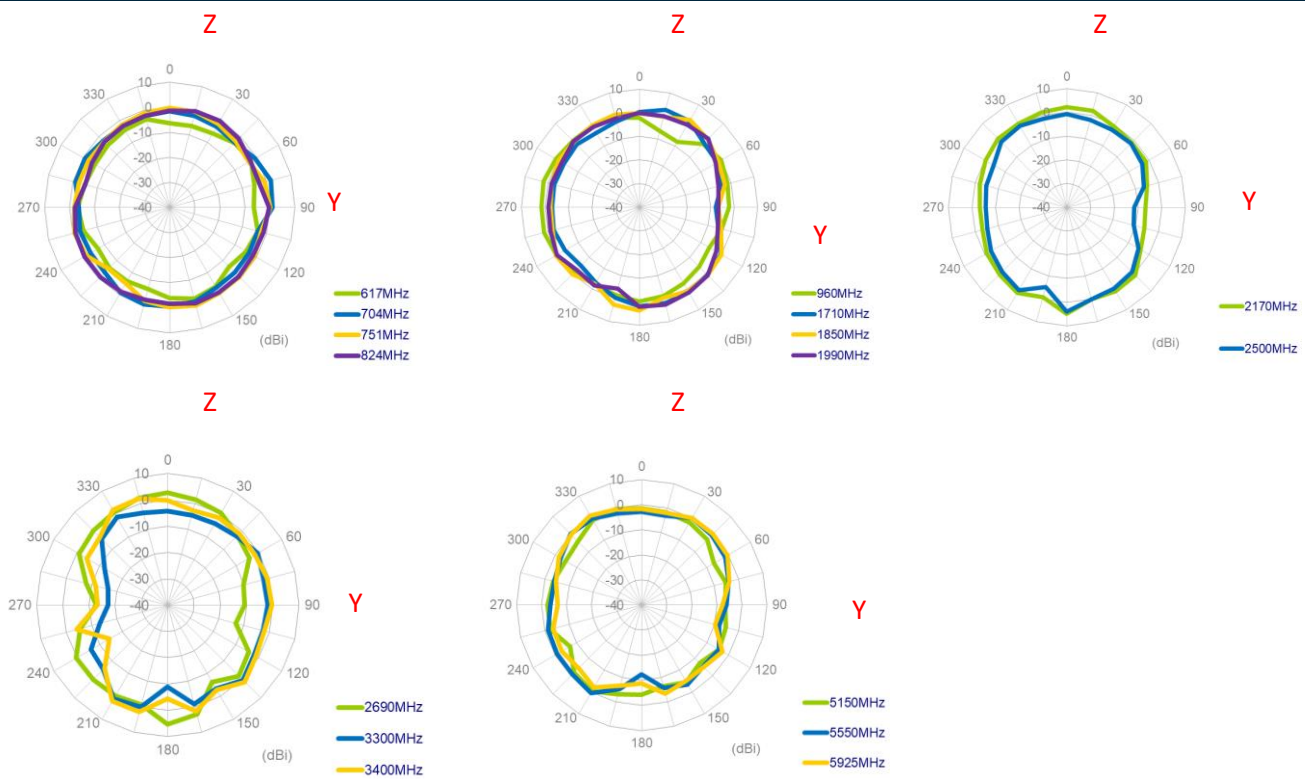

4.2.3 5G/4G MIMO3

XY Plane

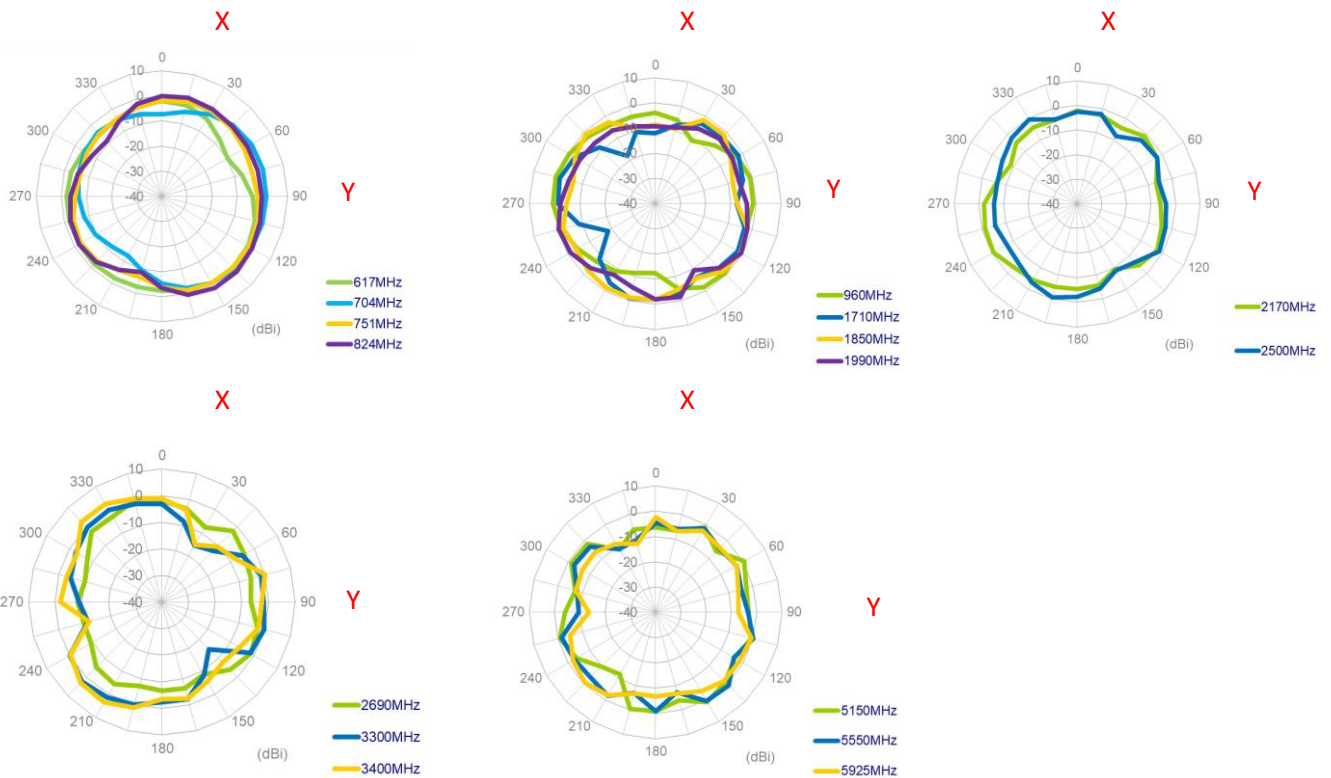

XZ Plane

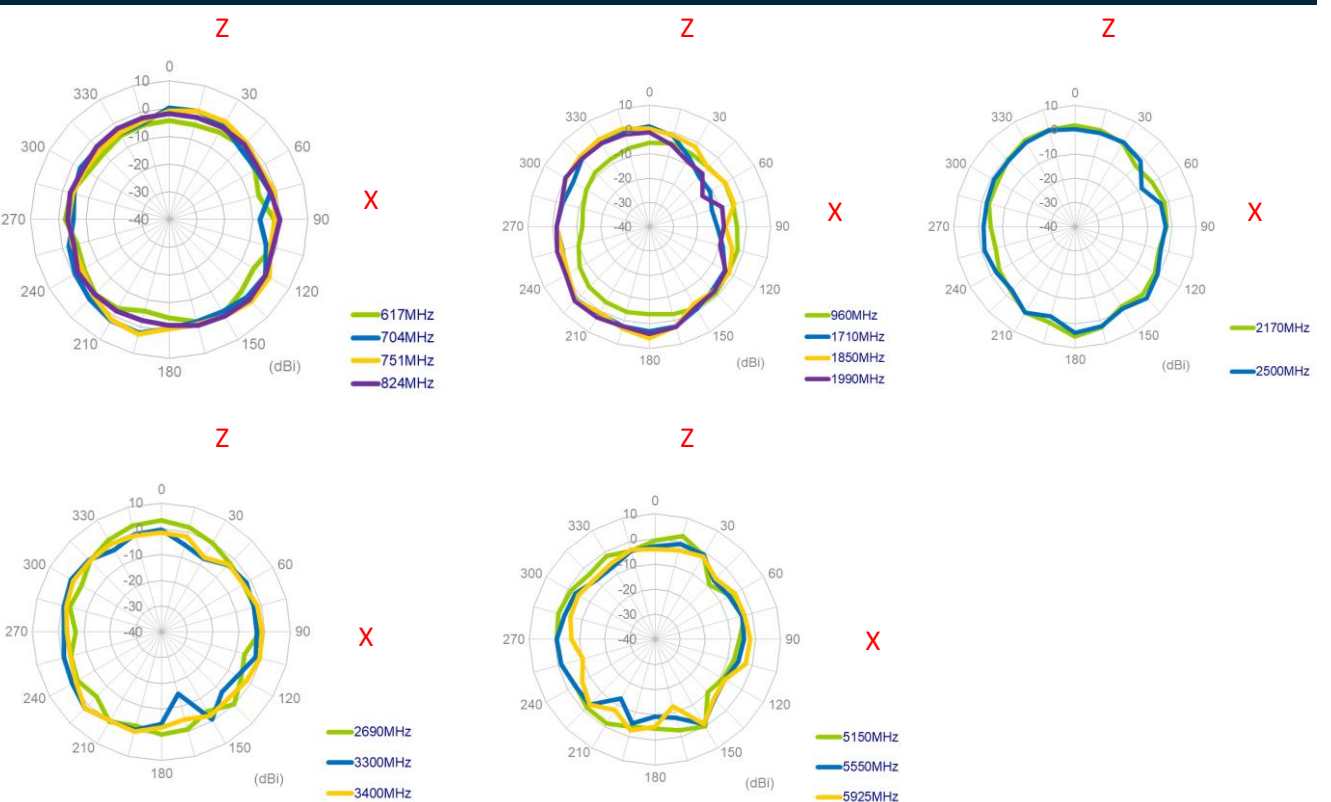

YZ Plane

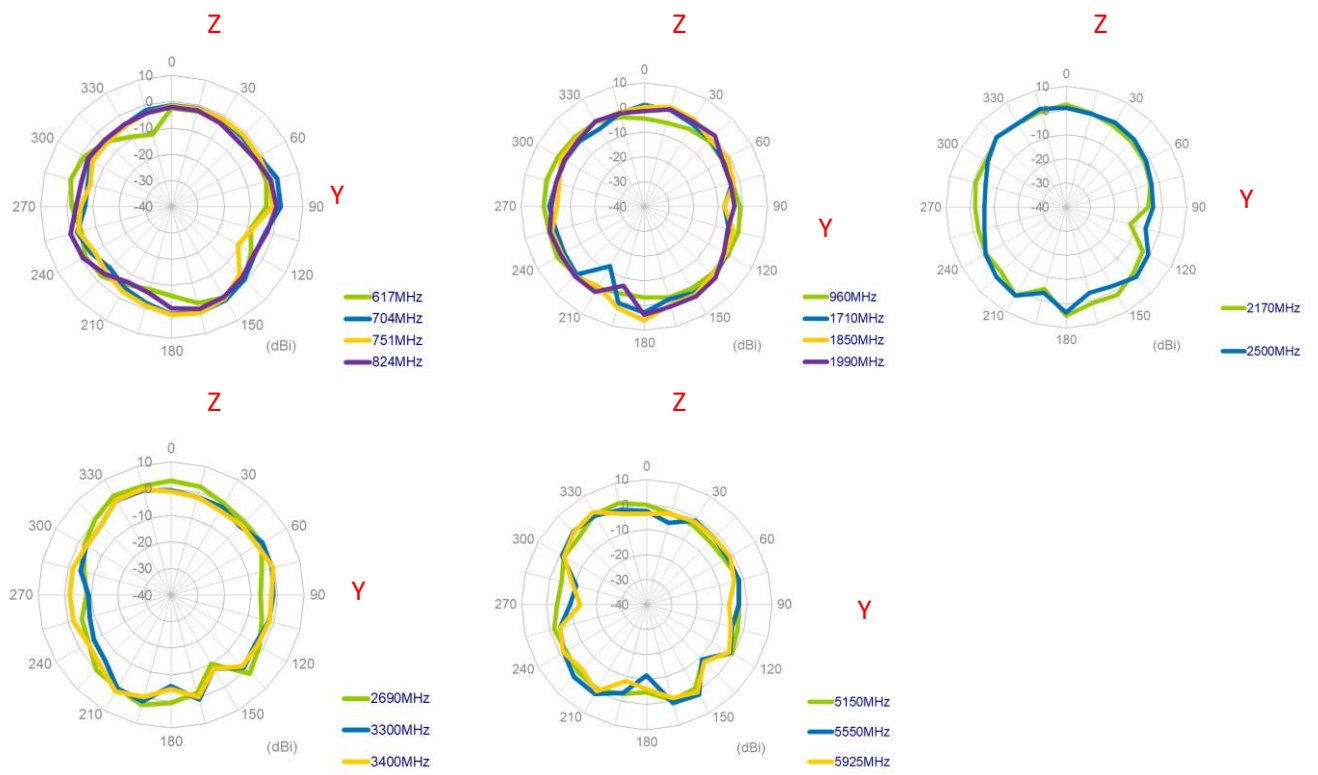

4.2.4 5G/4G MIMO4

XY Plane

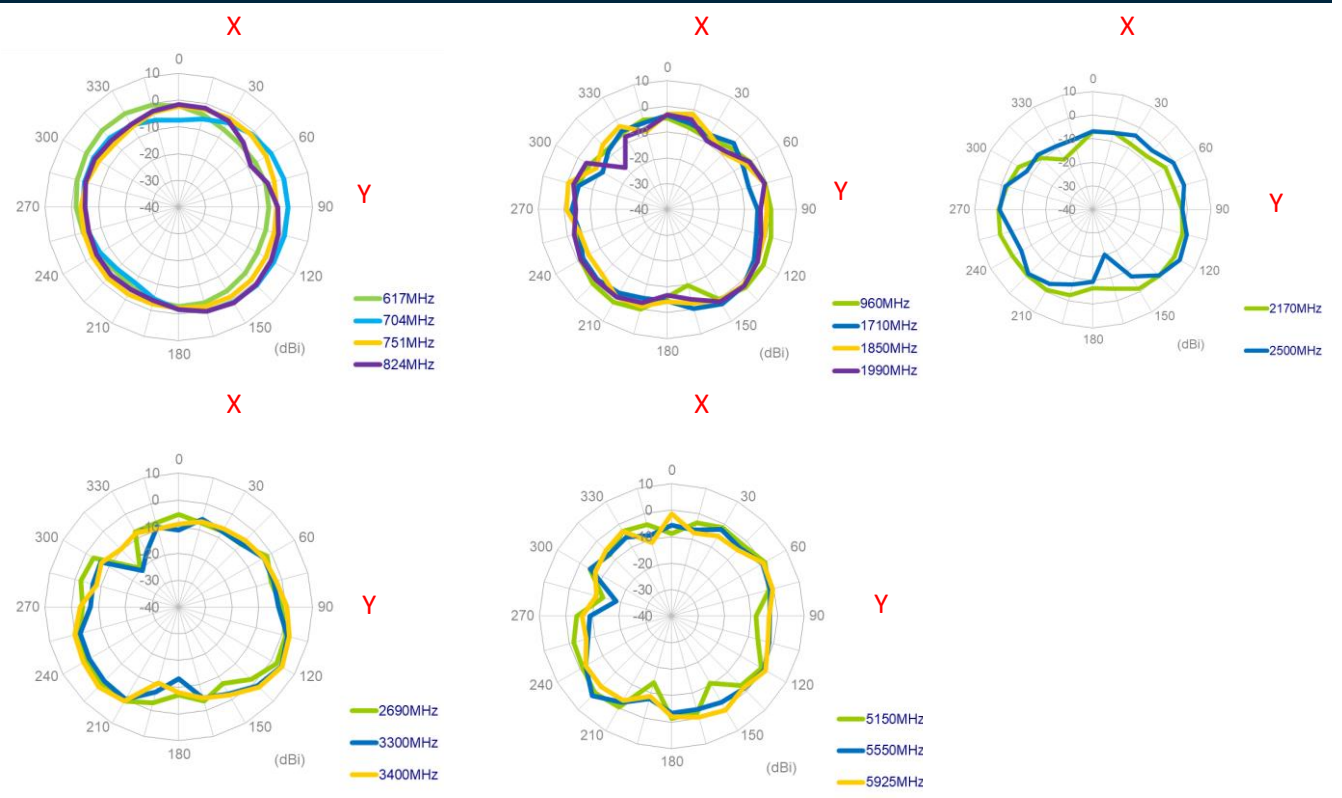

XZ Plane

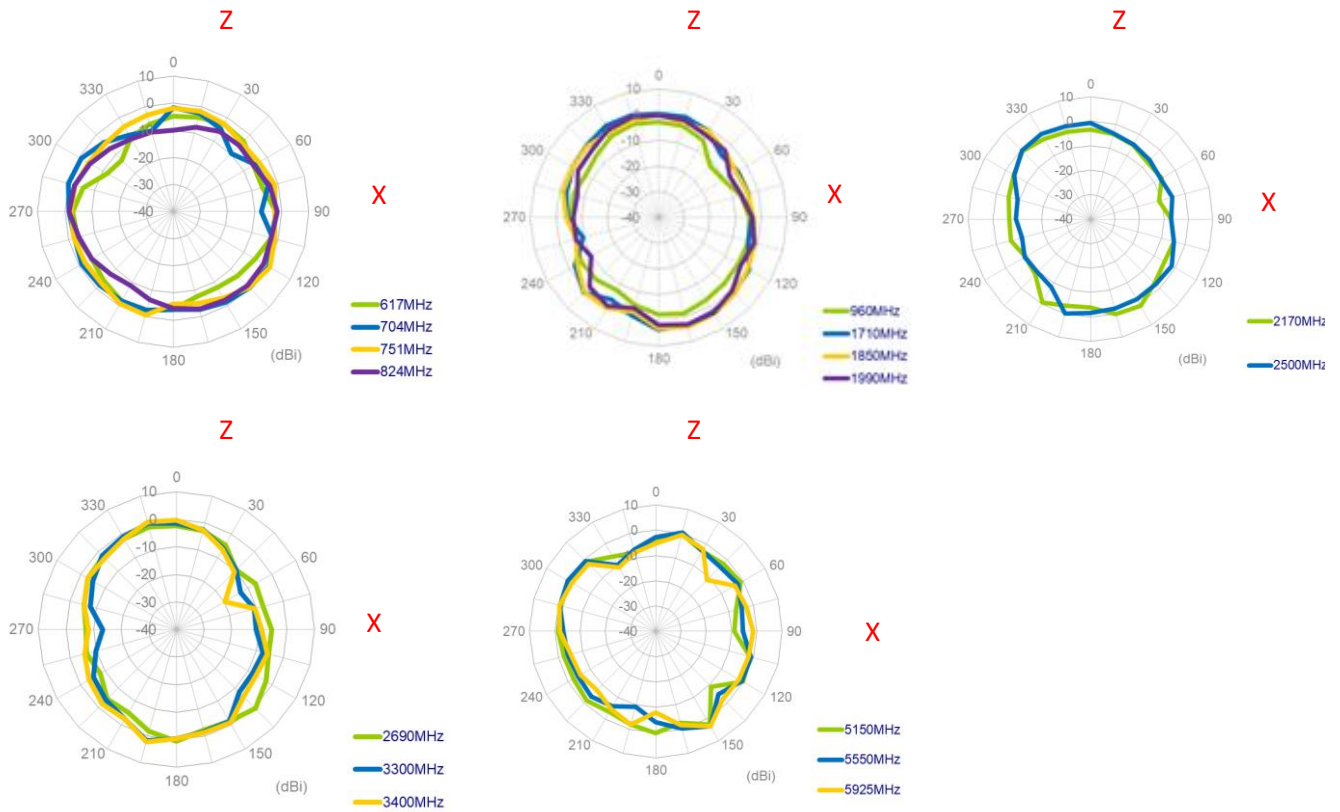

YZ Plane

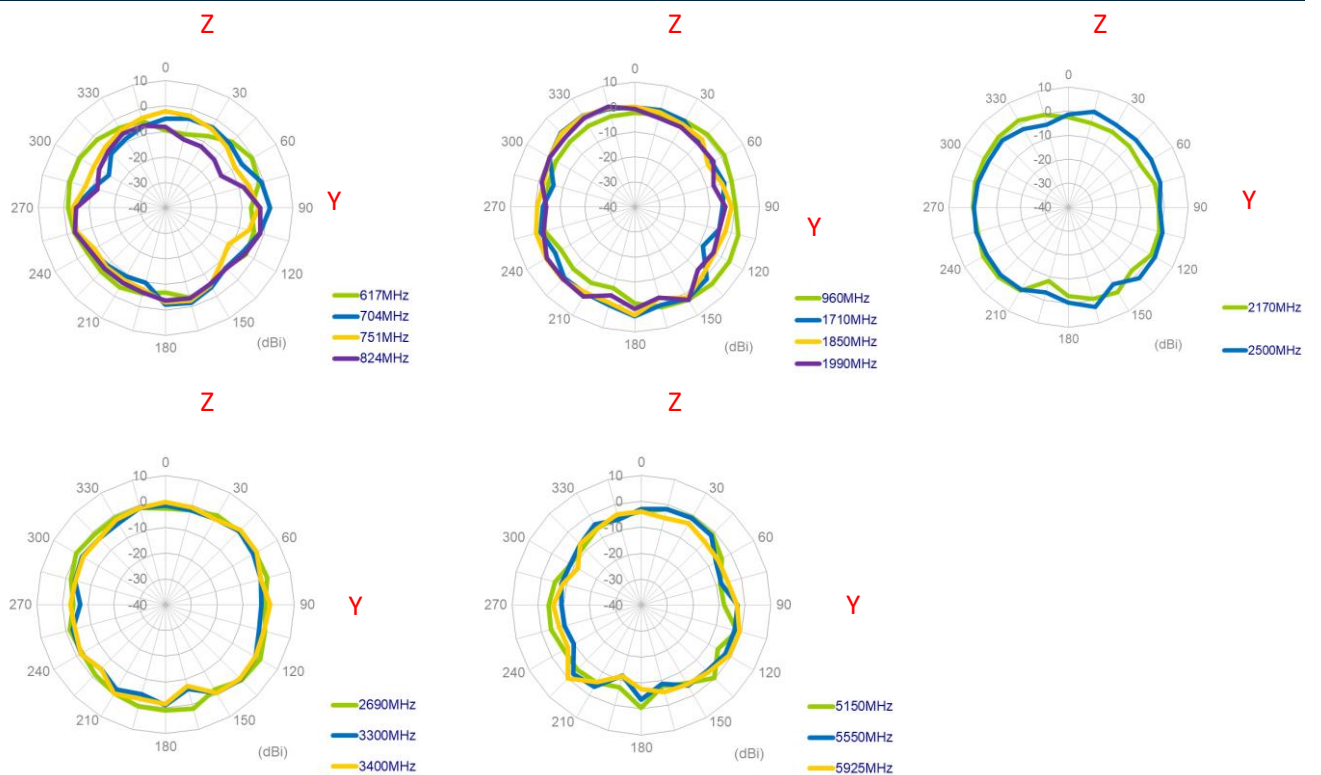

4.3 3D Radiation Pattern

4.3.1 5G/4G MIMO1

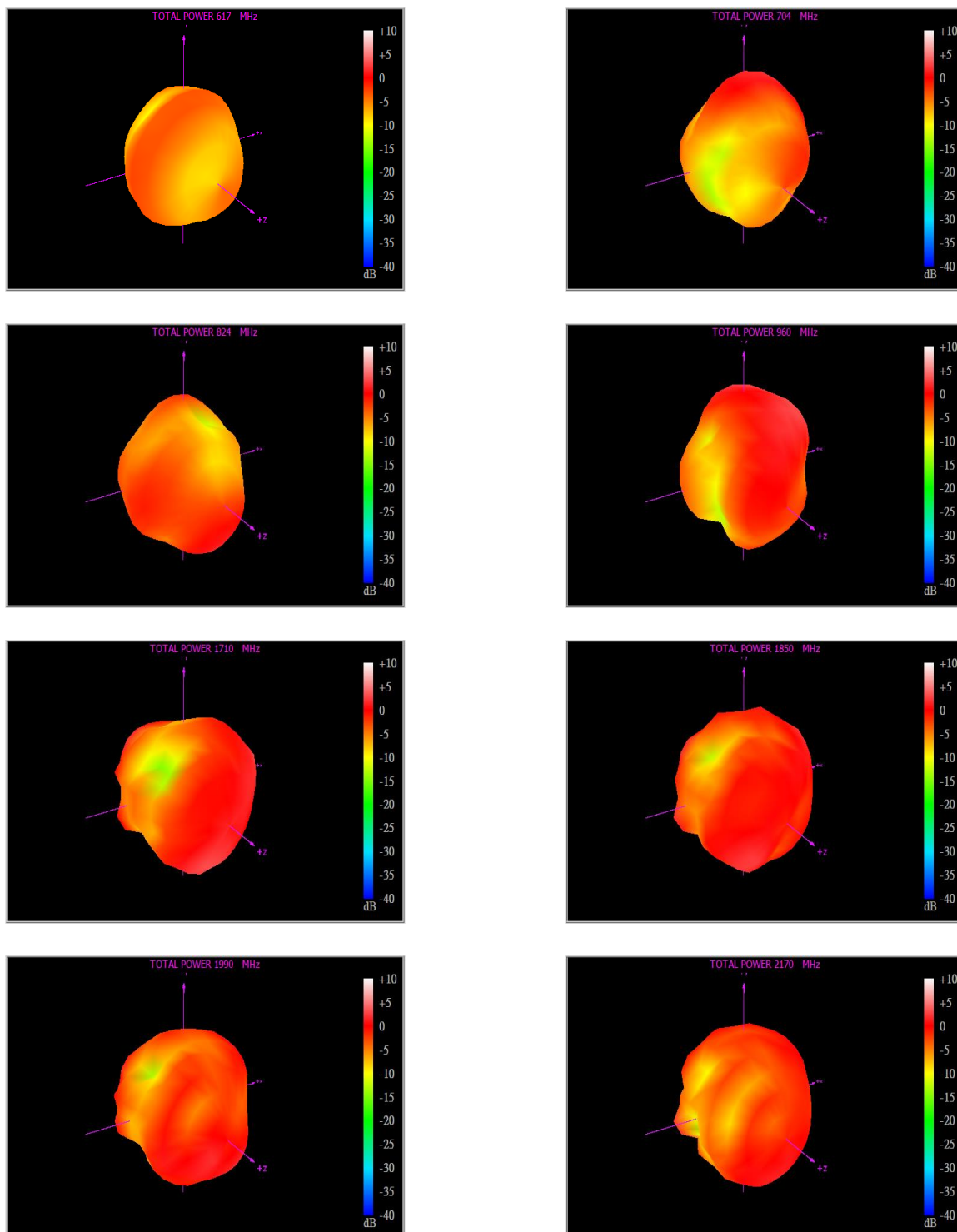

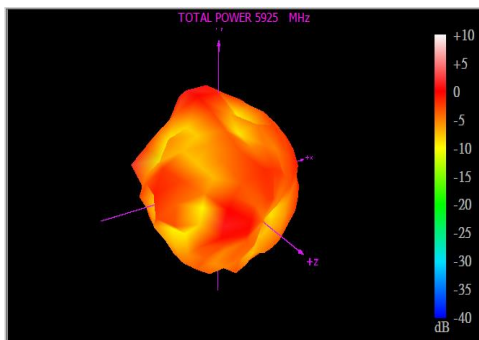
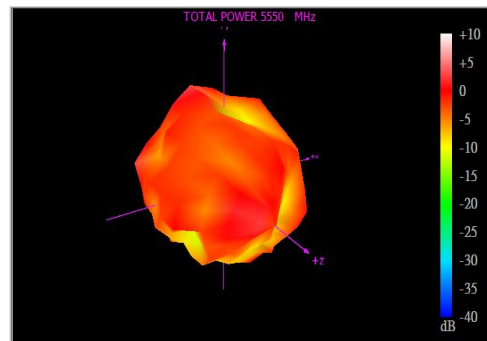
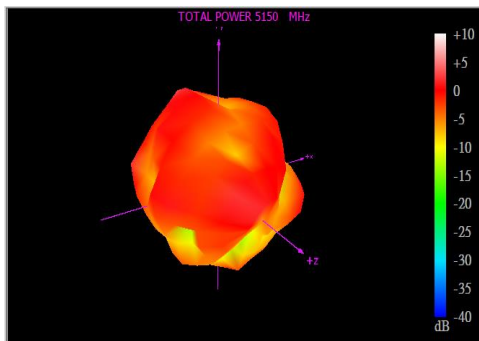
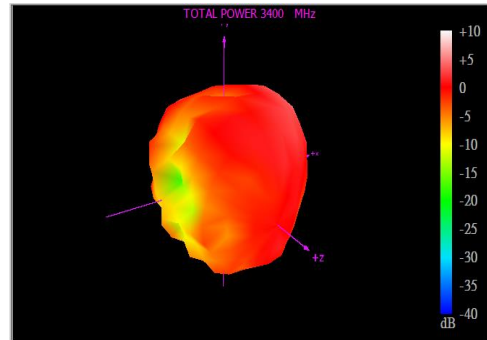
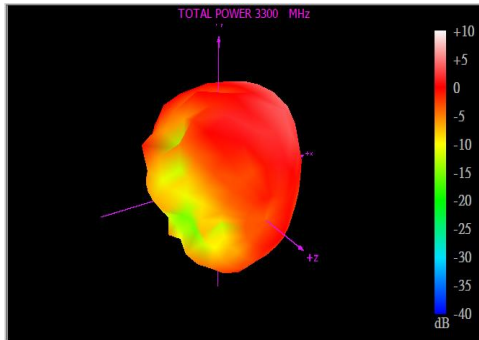
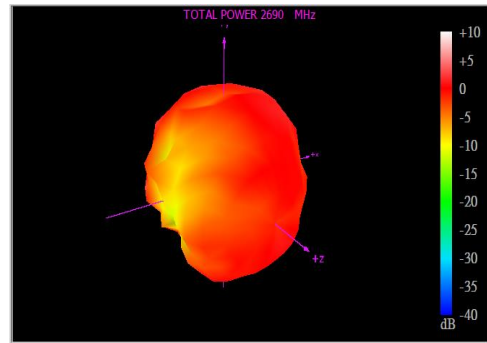
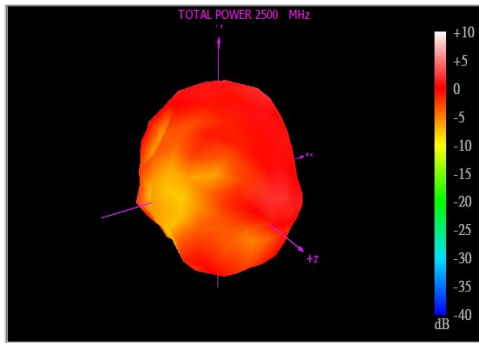

4.3.2 5G/4G MIMO2

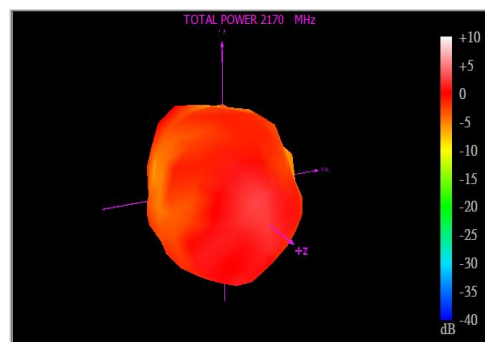
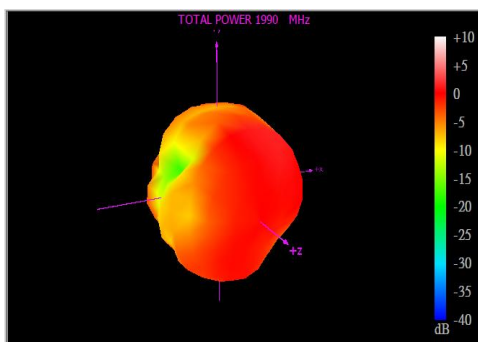
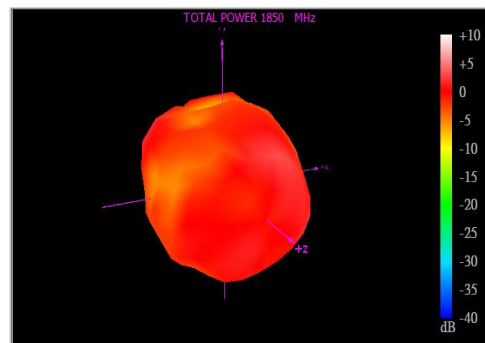
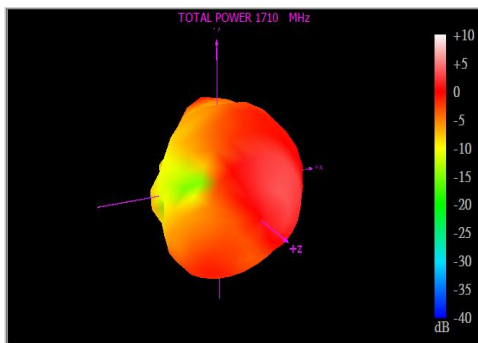
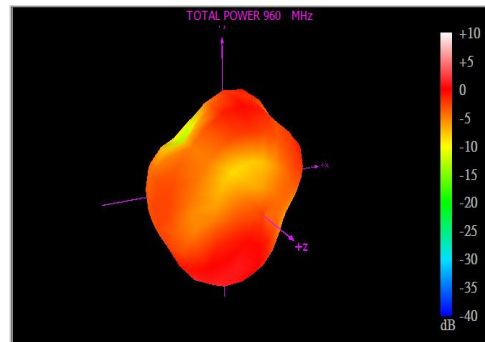
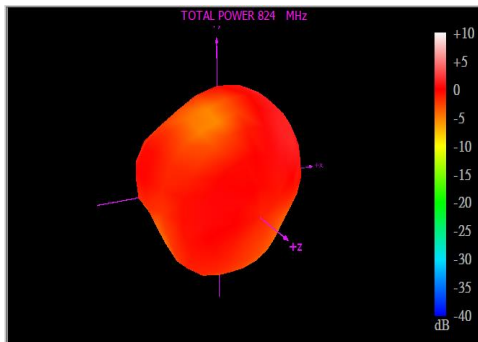
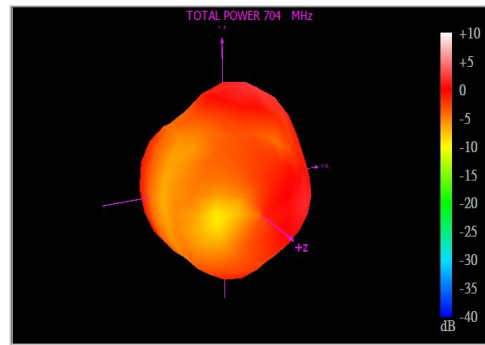
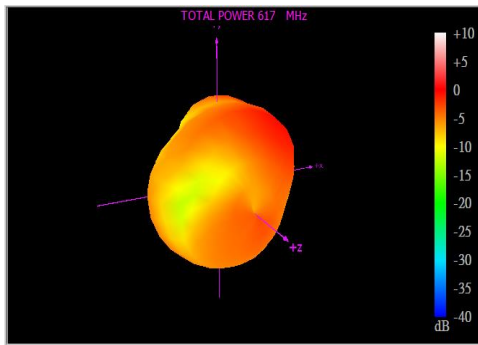

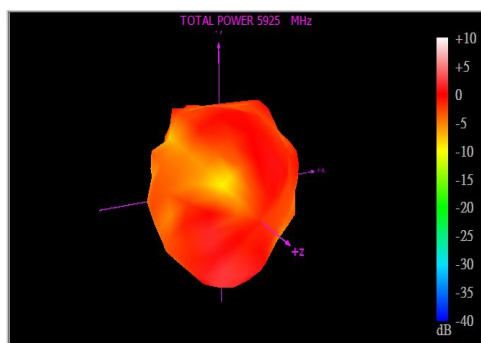
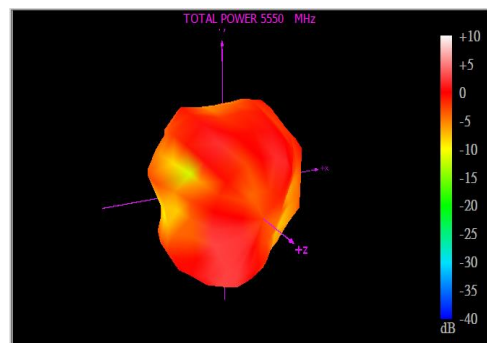
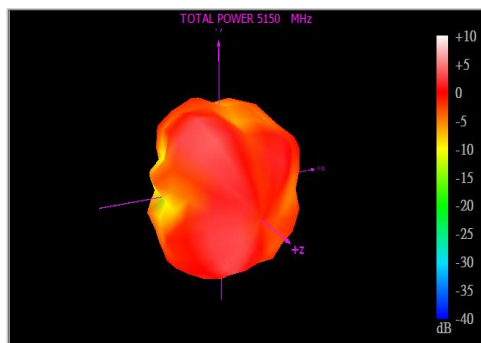
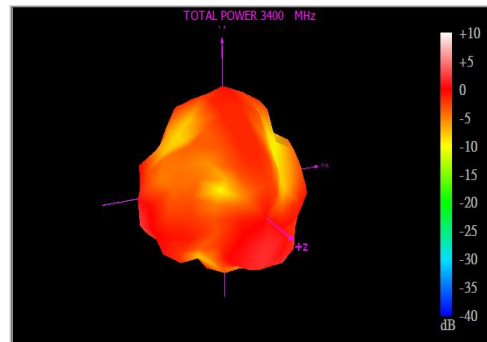
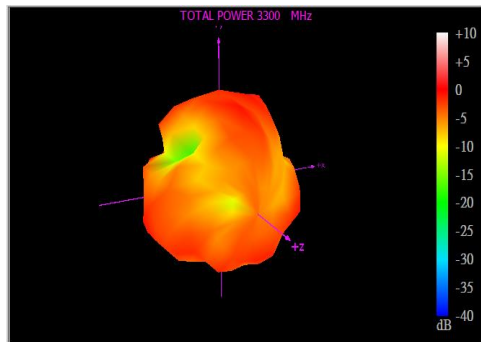
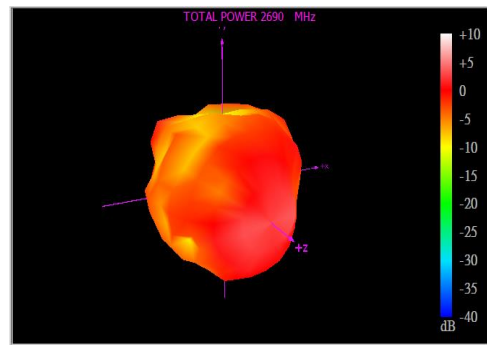
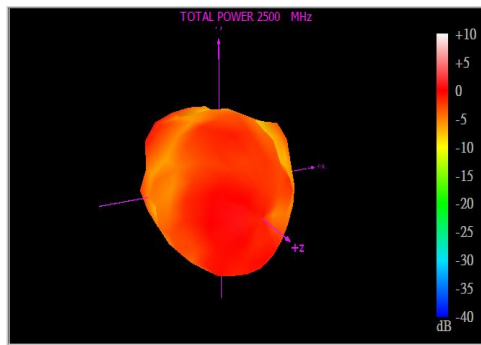

4.3.3 5G/4G MIMO3

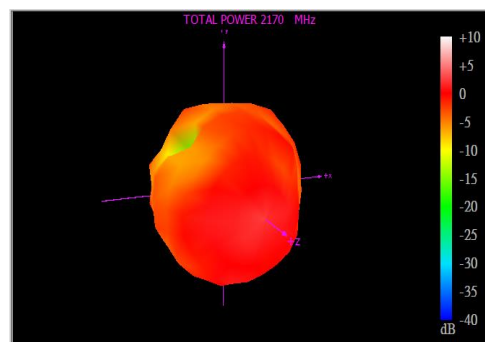
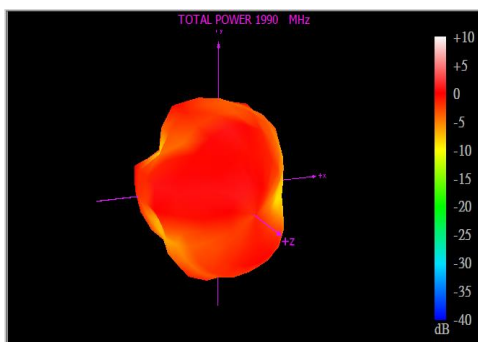
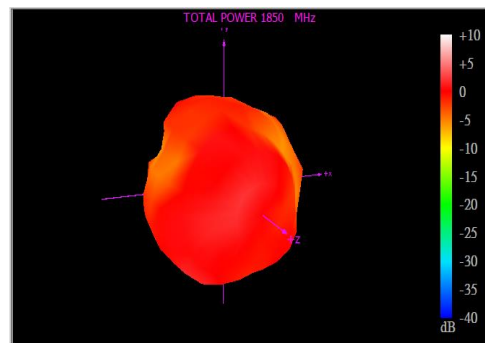
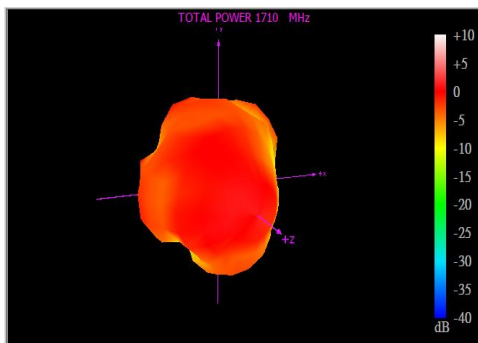
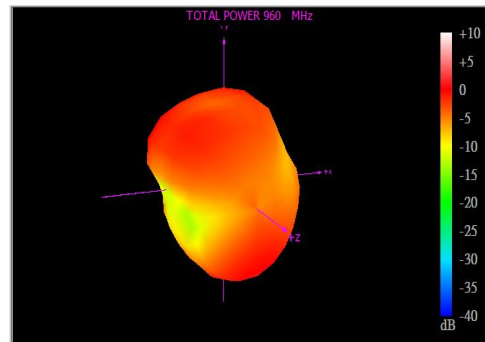
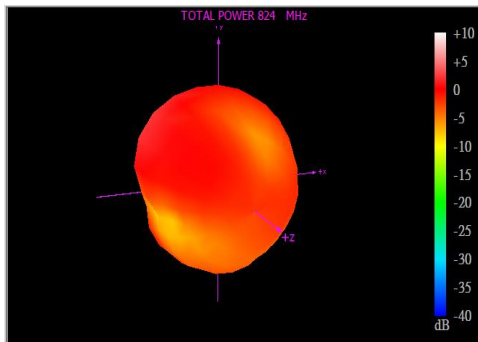
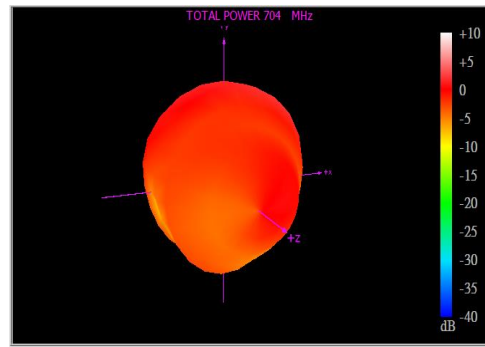
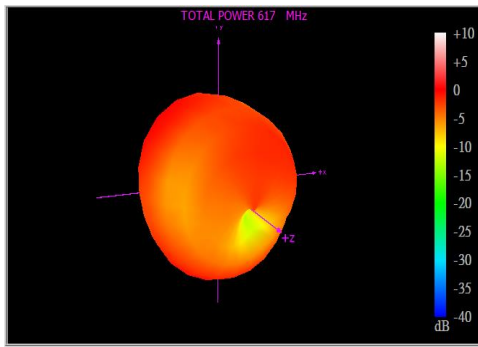

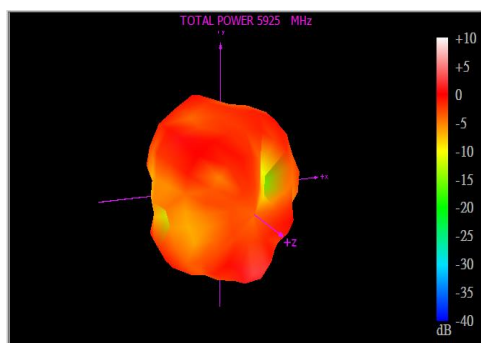
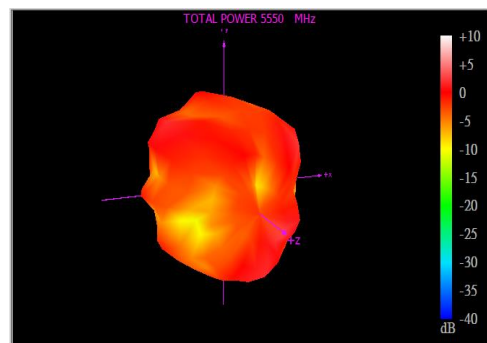
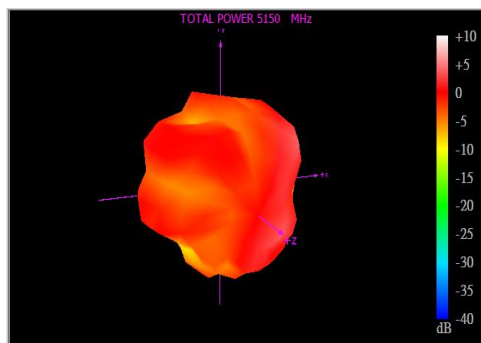
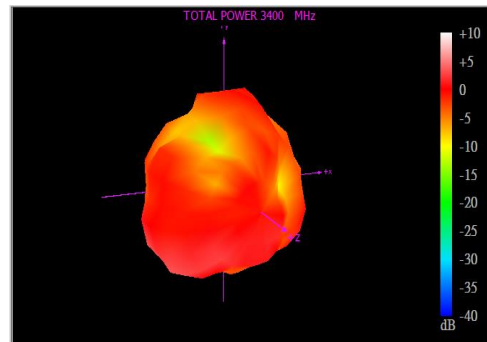
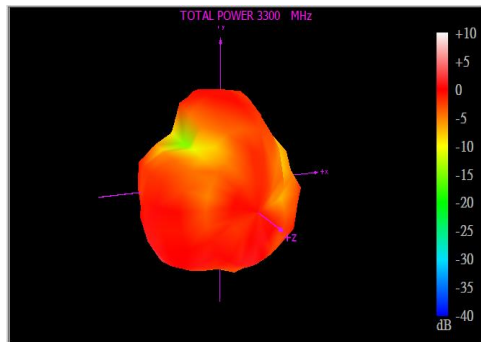
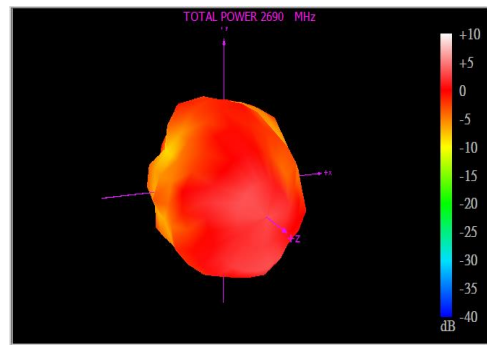
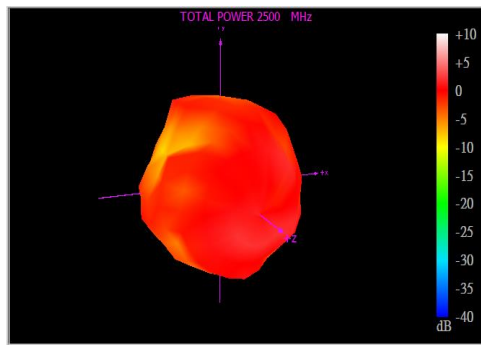

4.3.4 5G/4G MIMO4

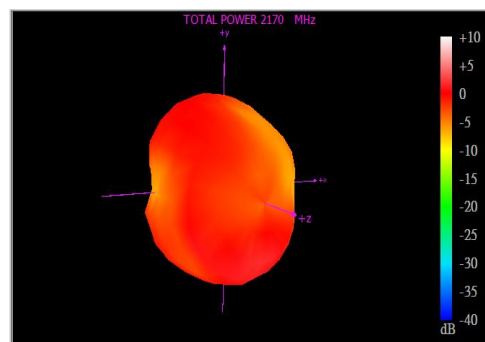
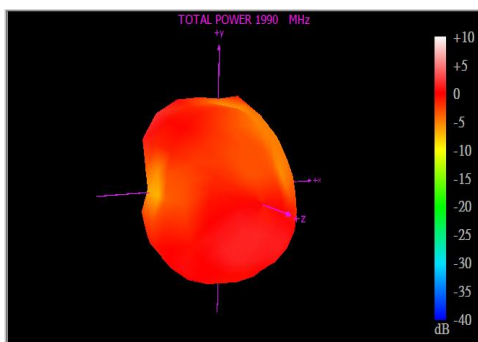
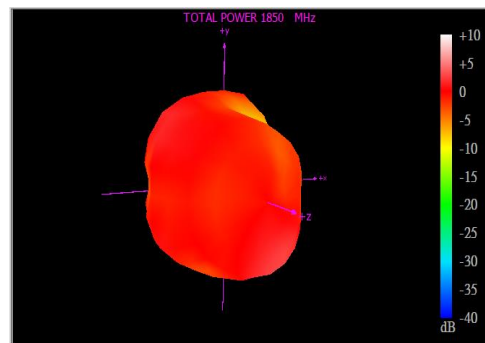
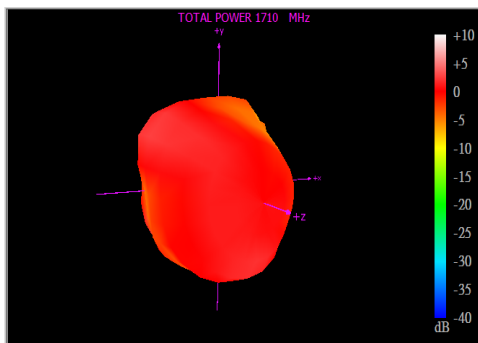
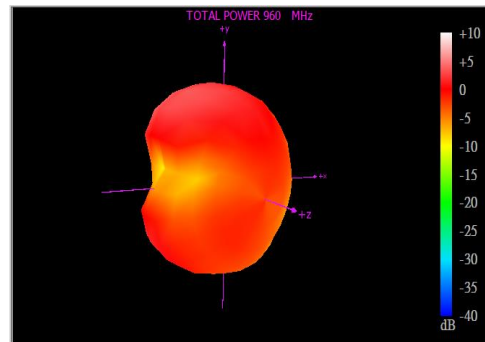
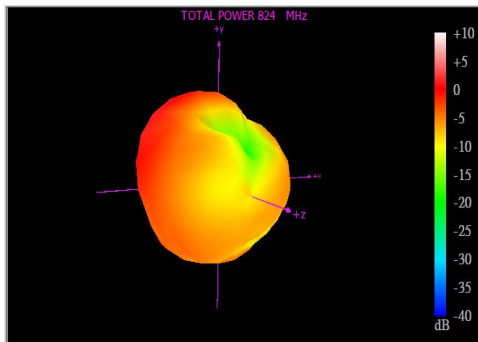
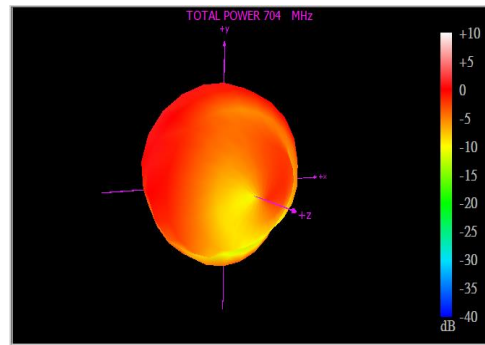
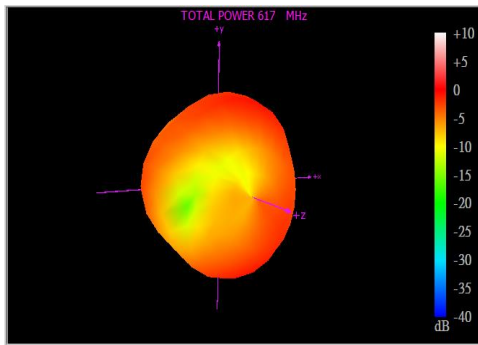

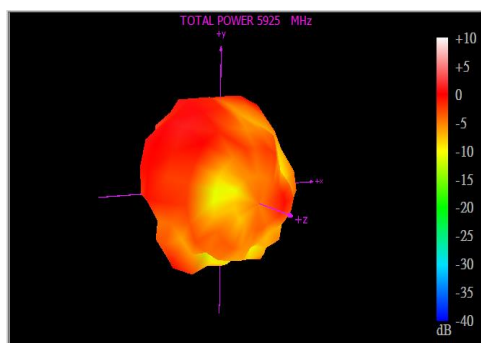
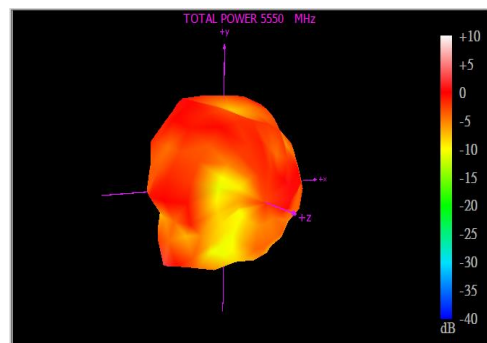
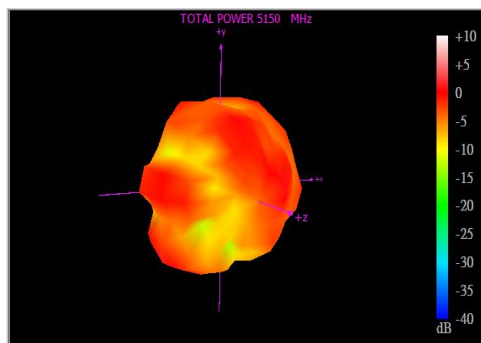
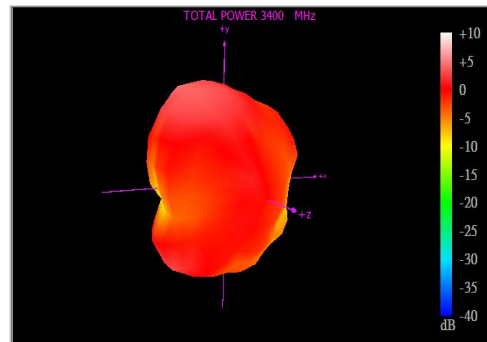
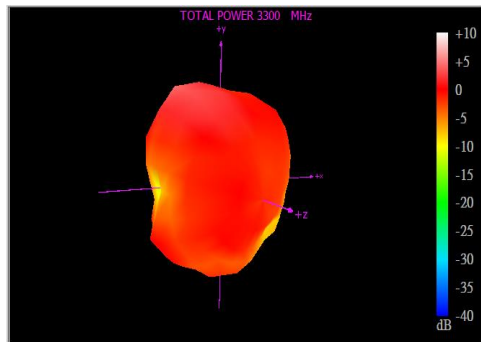
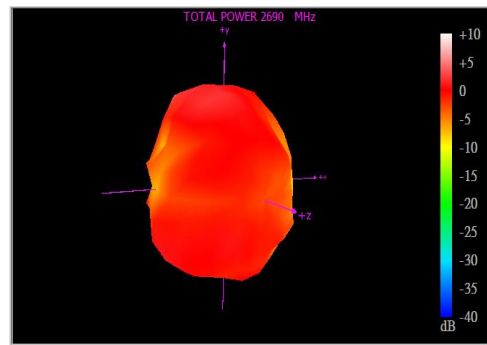
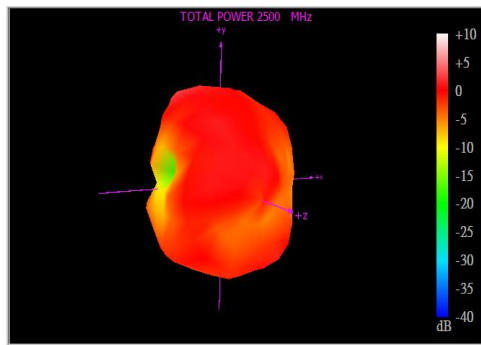

5. Mechanical Drawing (Units: mm)

ISO NO.: EDW-20-8-0568

STATE: Release

NOTES: 1. All material must be RoHS compliant.
2. The connector orientation has a fixed position to the antenna as per drawing.

REV.	DESCRIPTION	ENG.	APPROVED	DATE
001	Initial Design	Ruby	Clark	2020/06/30
002	Modify the Material <EC-21-08-004>	Amanda	Aaron	2021/01/22
003	Modify the Cable to TGC-200 and BOM	Ruby	Aaron	2021/02/02

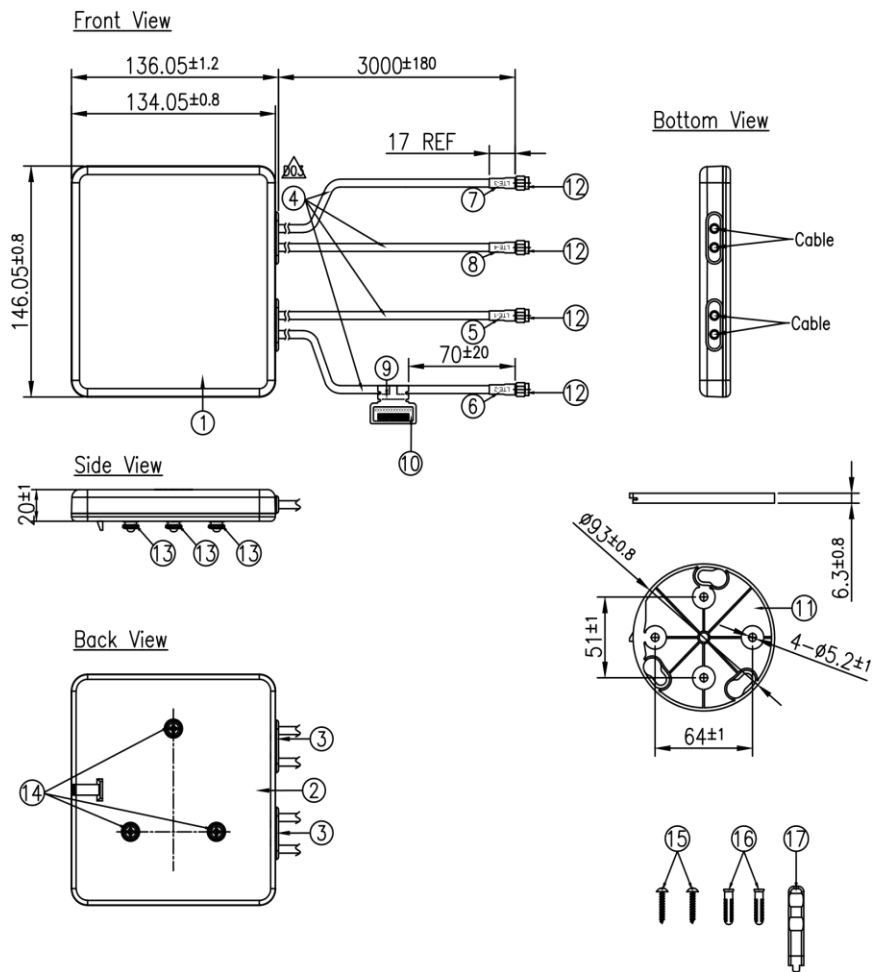

NO.	Name	Material	Finish	QTY
1	Top Housing	ASA	Black	1
2	Bottom Housing Bracket	ASA	Black	1
3	Rubber-2 Holes	Silicone Rubber	Black	2
4	TGC200 Coaxial Cable	PE	Black	4
5	Heat Shrink Tube (LTE-1)	PE	Red Tube/White Text	1
6	Heat Shrink Tube (LTE-2)	PE	Red Tube/White Text	1
7	Heat Shrink Tube (LTE-3)	PE	Red Tube/White Text	1
8	Heat Shrink Tube (LTE-4)	PE	Red Tube/White Text	1
9	Empty Label	PEPA	White	1
10	Barcode Label	PET	White	1
11	MA9 Series Bracket	ASA	Black	1
12	SMA(M)ST	Brass	Au Plated	4
13	Fastening Washer	ASA	Black	3
14	Screw TP1(SaBL)	Steel	Ni Plated	3
15	Screw TP4x25L	Steel	Ni Plated	2
16	Wall mount stud 8x24L	Nylon	White	2
17	Hook_Key	ASA	Black	1

APPROVED BY: Clark	<p>TW Design Centre This drawing and its inherent design concepts are property of Taoglas. Not to be copied or given to third parties without the written consent of Taoglas.</p>
CHECK BY: Aaron	
DRAWN BY: Ruby	
DATE: 2020/06/30	
UNLESS OTHERWISE SPECIFIED TOLERANCES ON:	<p>TITLE : Guardian 4in1 Wall Mount Antenna - 4* Wideband LTE MIMO 600-8000MHz with 3m TGC-200 & SMA(M)</p> <p>PART NO. : MA963.A.BIVW.002.wm</p>
THIRD ANGLE PROJECTION	<p>UNIT: mm SCALE: 1:4 PAGES: 1/1 REV. D03</p>

6. Installation Instructions

Introduction

Following these guidelines will help ensure that your Taoglas Guardian antenna is installed correctly. The Guardian is simply mounted via a wall mount bracket, details outlined below.



Electrical Safety

The Pantheon contain an active GPS/GNSS antenna.
Rated voltage: 3-5VDC Rated current: 20mA maximum

The supply to this device must be provided with overcurrent protection of 1A maximum.

Power consumption@1.8V (mA) 8.7 mA

Power consumption@3.0V (mA) 9.0 mA

Power consumption@5.5V (mA) 11 mA

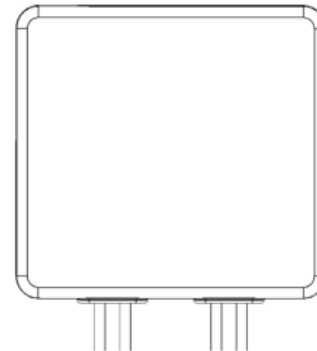

Installation Requirements

Antenna Components:

- Antenna Enclosure x 1
- Mounting Bracket x1
- Screws x2
- Rawl Plugs x2

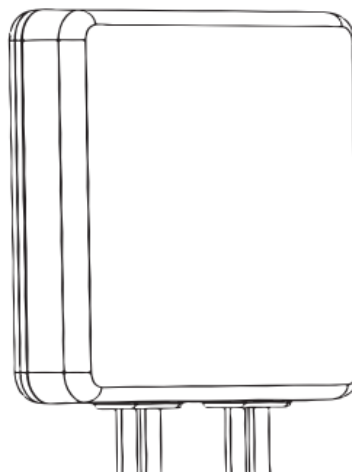
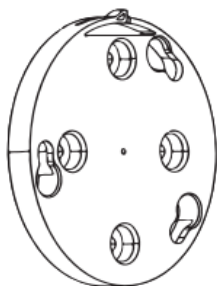

Tools Required:

Screwdriver, drill, M4 [Gauge 8]

Wall Mount

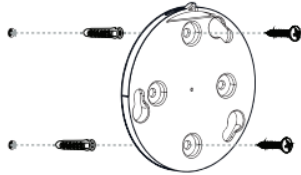

1. Using the mounting bracket as guide, mark the position of the wall screws to the desired location of the bracket. Drill holes for the wall mount studs (6mm [1/4"] diameter, min. 25mm [1"] depth) and secure the studs in place. Insert screws through the bracket holes and into the wall studs. Tighten the screw to secure the mounting bracket to the wall.

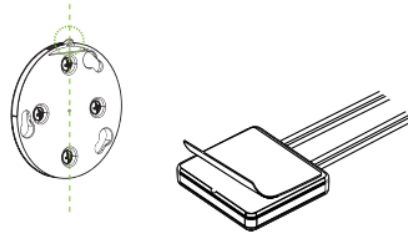

2. Connect the the back of the antenna to the brakcet via the 3 built-in mounting points on the rear of the antenna.
Note: The locking mechanism is highlighted in green.

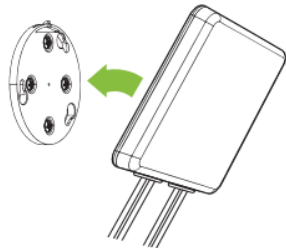

3. Press the antenna into the open area of the holes on the bracket via the mounting points.
Note: The antenna and bracket should be mounted level on the horizontal plane.

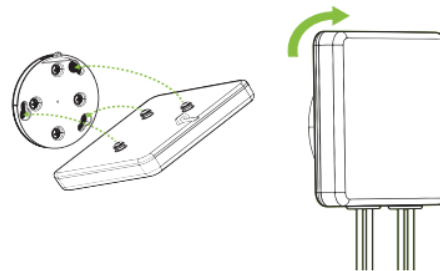

4. Rotate the Antenna in to the bracket by turning slightly. The locking mechanism on the bracket and back of the antenna should be connected together at the point.

5. Completed Installation of the .

Note: The bracket should be flush with antenna.

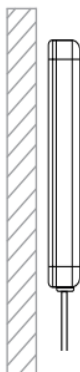

Notices



Caution

To comply with FCC RF Exposure requirements in section 1.1310 of the FCC Rules, antennas used with this device must be installed to provide a separation distance of at least 20 cm from all persons to satisfy RF exposure compliance.



Warning

Do not Operate the transmitter when someone is within 20 cm of the antenna.
Do not operate the equipment in an explosive atmosphere.



European Waste Electronic Equipment Directive 2002/96/EC

Please ensure that your old Waste Electricals and Electronics are recycled do not throw them away into standard waste.

Waiver: This document represents information compiled by Taoglas to the best of our current knowledge. This is not intended to be used as a representation or warranty of fitness of the products described for any particular purpose. This document details guidelines for general information purposes only. When planning installations, always seek specialist advice and ensure that the products are always installed by a properly qualified installer in accordance with applicable regional laws and regulations.

All copyrights, trademarks and any other intellectual property rights related are owned by Taoglas Group Holdings Limited.

7. Packaging

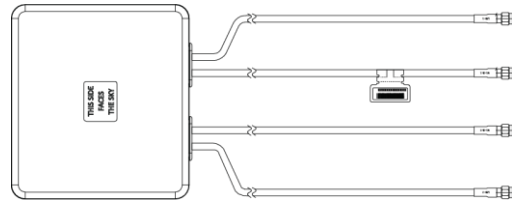

1 MA963.A.BIVW.002.wm per small box
 Box Dimensions - 260*240*100mm
 Weight - 850g

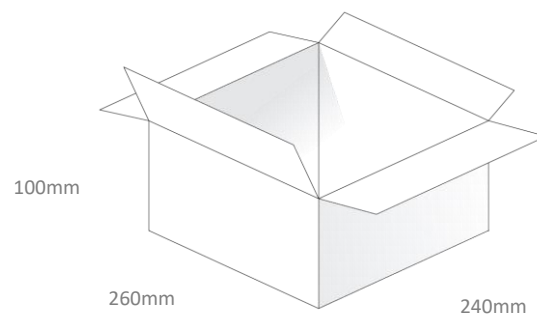

8 pcs MA963.A.BIVW.002.wm per carton
 Box Dimensions - 540*490*240mm
 Weight - 8Kg

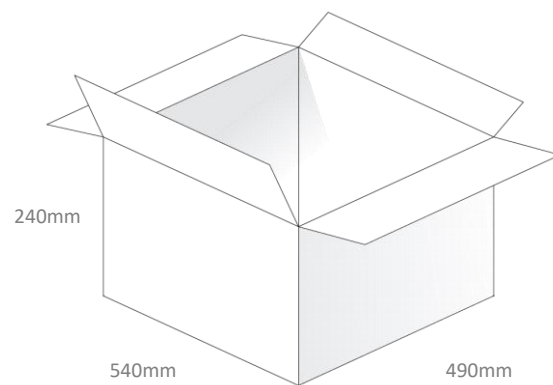

Pallet Dimensions:
 1200*1000*1400mm
 20 Cartons per Pallet
 4 Cartons per layer, 5 Layers

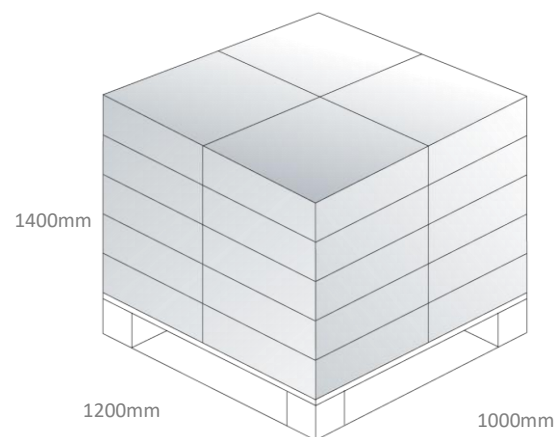

Changelog for the datasheet

SPE-20-8-102 – MA963.A.BIVW.002.wm

Revision: E (Current Version)	
Date:	2023-07-11
Changes:	Updated Installation Instructions
Changes Made by:	Cesar Sousa

Previous Revisions

Revision: D	
Date:	2022-07-11
Changes:	Specification updated
Changes Made by:	Cesar Sousa

Revision: C	
Date:	2021-04-21
Changes:	Added Installation Guidelines
Changes Made by:	Jack Conroy

Revision: B	
Date:	2021-02-26
Changes:	Packaging Updated
Changes Made by:	Jack Conroy

Revision: A (Original First Release)	
Date:	2020-07-23
Notes:	Initial Datasheet Release
Author:	Jack Conroy