

# Specification

- Part No. : **MA9908.A.001**
- Product Name : GuardianX 1M 8in1 1\*Active GNSS 4\*LTE MIMO  
3\*WiFi MIMO
- Features : Low-profile Housing with Wall Mount  
4\* LTE MIMO 698 to 960MHz/1710 to 2170MHz/ 2490 to 2690MHz/ 3300 to 3600MHz  
3\* WIFI MIMO 2.4GHz/5.8 GHz  
1\* GPS-GLONASS- Antenna  
Worldwide 4G Bands including 3G and 2G  
IP67 Waterproof Enclosure  
Dims: 360mm \* 160mm \* 16.5mm  
1M Low Loss TGC-200 and RG174 with SMA(M)/RP-SMA(M) connectors  
Custom Cables and Connectors Available  
**RoHS Compliant**



## 1. Introduction

The Taoglas GuardianX MA9908.A.001 is a low profile heavy duty, fully IP67 waterproof external antenna. Combining 8 elements into one antenna, 1 GPS/GLONASS/Galileo, 4\* LTE MIMO (698 to 960MHz/1710 to 2170MHz/ 2490 to 2690MHz/ 3300 to 3600MHz) and 3\* Dual-band Wi-Fi MIMO 2.4-5.8GHz. This unique product delivers powerful worldwide 4G LTE MIMO antenna technology at 700MHz/800MHz/1700MHz/1800MHz/2600MHz and dual band Wi-Fi.

Typical applications include:

- Passenger Bus / Rail / Air Applications.
- Automotive and Heavy Equipment Vehicle Tracking and Telematics
- Remote Asset and Pipeline Monitoring
- HD Video over LTE
- First Responder and Emergency Services
- M2M Applications/IoT

LTE 4G applications demand high speed data uplink and downlink. High efficiency and high gain MIMO antennas are necessary to achieve the required signal to noise ratio and throughput required to solve these challenges. Taoglas also takes care to have high isolation between the two MIMO antennas to prevent self-interference. Low loss cables are used to keep efficiency high over long cable lengths. In contrast, smaller MIMO antennas with poorer quality thinner cables will have much reduced efficiency and isolation, which would lead to a large drop in system throughput, increased number of drops, and may indeed not make a system connection at all.

Cable length and connector types are customizable. Contact your regional Taoglas sales office for support.

## 2. Specification

2.4GHz/5.8GHz MIMO Antenna			
Frequency (MHz)		2400~2500	5150~5850
Efficiency (%)			
MIMO_1	1M	71.50	59.78
MIMO_2	1M	79.81	59.22
MIMO_3	1M	79.96	59.13
Average Gain (dBi)			
MIMO_1	1M	-1.46	-2.23
MIMO_2	1M	-0.98	-2.28
MIMO_3	1M	-0.97	-2.28
Peak Gain (dBi)			
MIMO_1	1M	4.08	3.47
MIMO_2	1M	4.53	4.47
MIMO_3	1M	4.89	5.71

2G/3G/4G MIMO Antenna								
Frequency (MHz)		LTE700	GSM850	GSM900	DCS	PCS	UMTS1	LTE2600
		698~824	824~894	880~960	1710~1880	1850~1990	1920~2170	2490~2690
Efficiency (%)								
MIMO_1	1M	57.15	49.97	40.80	61.56	60.82	57.58	52.02
MIMO_2	1M	58.48	54.30	46.08	66.07	66.98	64.51	56.55
MIMO_3	1M	52.24	60.09	53.84	65.28	67.19	67.71	71.62
MIMO_4	1M	52.24	60.09	53.84	65.28	67.19	67.71	71.62
Average Gain (dBi)								
MIMO_1	1M	-2.43	-3.01	-3.89	-2.11	-2.16	-2.40	-2.84
MIMO_2	1M	-2.33	-2.65	-3.36	-1.80	-1.74	-1.90	-2.48
MIMO_3	1M	-2.82	-2.21	-2.69	-1.85	-1.73	-1.69	-1.45
MIMO_4	1M	-2.82	-2.21	-2.69	-1.85	-1.73	-1.69	-1.45
Peak Gain (dBi)								
MIMO_1	1M	1.41	1.53	1.04	3.17	3.54	3.91	4.23
MIMO_2	1M	1.29	1.90	1.67	4.07	4.07	4.15	5.10
MIMO_3	1M	2.17	2.51	2.44	3.32	3.32	3.59	5.63
MIMO_4	1M	2.17	2.51	2.44	3.32	3.32	3.59	5.63
Impedance	50 Ω							
Polarization	Linear							

<b>CERAMIC PATCH</b>			
Frequency	1574~1610MHz		
Gain @ Zenith	1575.42MHz 1.5 dBic Typ. @ Zenith 1602MHz +0 dBic Typ. @ Zenith		
Gain at 90° with LNA	1575.42MHz: 31 ± 3dBic 1602MHz: 30 ± 3dBic		
Polarization	RHCP		
Axial Ratio	6.0dB max. @ 1575.42MHz Zenith 14.0dB max. @ 1602MHz Zenith		
Patch Dimension	25.1*25.1*4mm		
<b>LNA</b>			
Frequency	1574~1610MHz		
Outer Band Attenuation	1592±140MHz 15dB min.		
Output Impedance	50Ω		
Output VSWR	2.0 Max		
Pout at 1dB Gain	Typ. -2dBm		
Compression point	Min. -6dBm		
Input Voltage	Min:1.8V Typ. 3.0V Max:5V		
LNA Gain, Power Consumption and Noise Figure			
Input Voltage	Min:1.8V	Typ. 3.0V	Max: 5.5V
Total Gain @ Zenith	25dBic	31dBic	34dBic
Current Consumption	5mA	10mA	23mA
Noise Figure	3dB	3dB	3.3dB
Cable	3m RG174 standard, fully customizable		
Connector	SMA(M) standard, standard, fully customizable		

<b>MECHANICAL</b>	
Dimensions	360mm * 160mm * 16.5mm
Cable	1M TGC200 for LTE/WIFI – Fully Customizable 1M RG174 for GNSS – Fully Customizable
Connector	LTE_SMA-Plug – Fully Customizable WIFI_RP-SMA-Plug – Fully Customizable GNSS_SMA-Plug – Fully Customizable
Casing	UV Resistant PC
Sealant	Rubber Stopper
Weight	1250g
<b>ENVIRONMENTAL</b>	
Protection	IP67
Temperature Range	-40°C to +85°C
Thermal Shock	100 cycles -40°C to +85°C
Humidity	Non-condensing 65°C 95% RH

### 3. Antenna Characteristics

#### 3.1 Block Diagram (Active antenna)

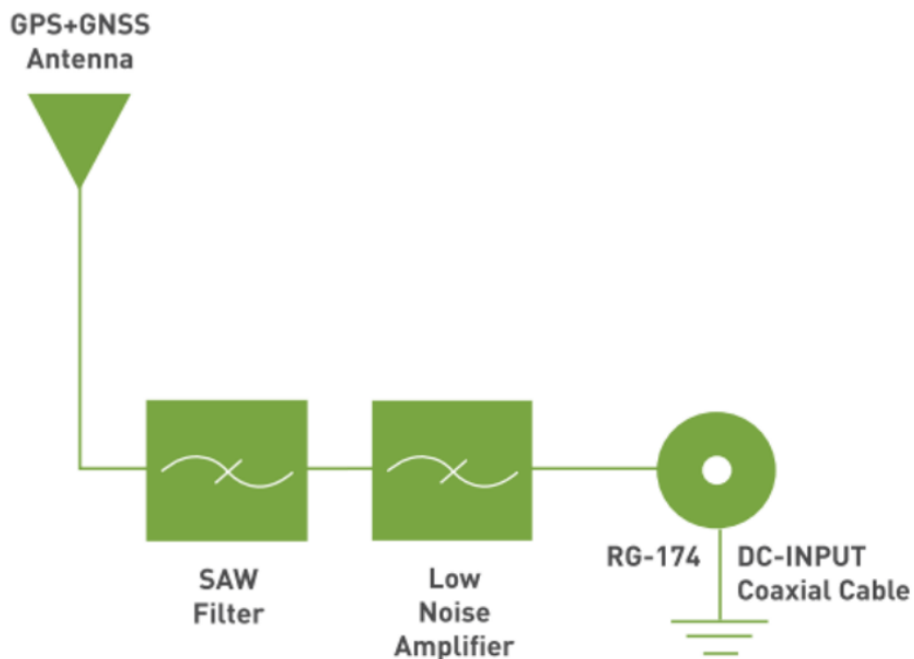
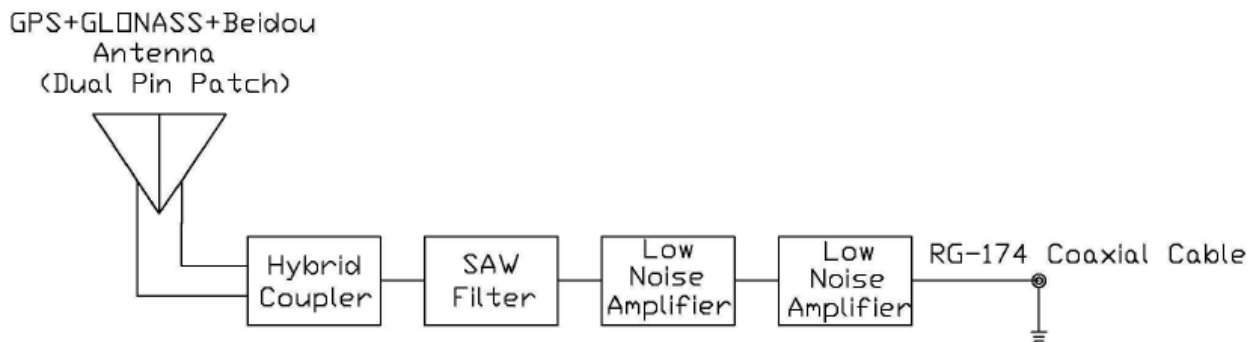
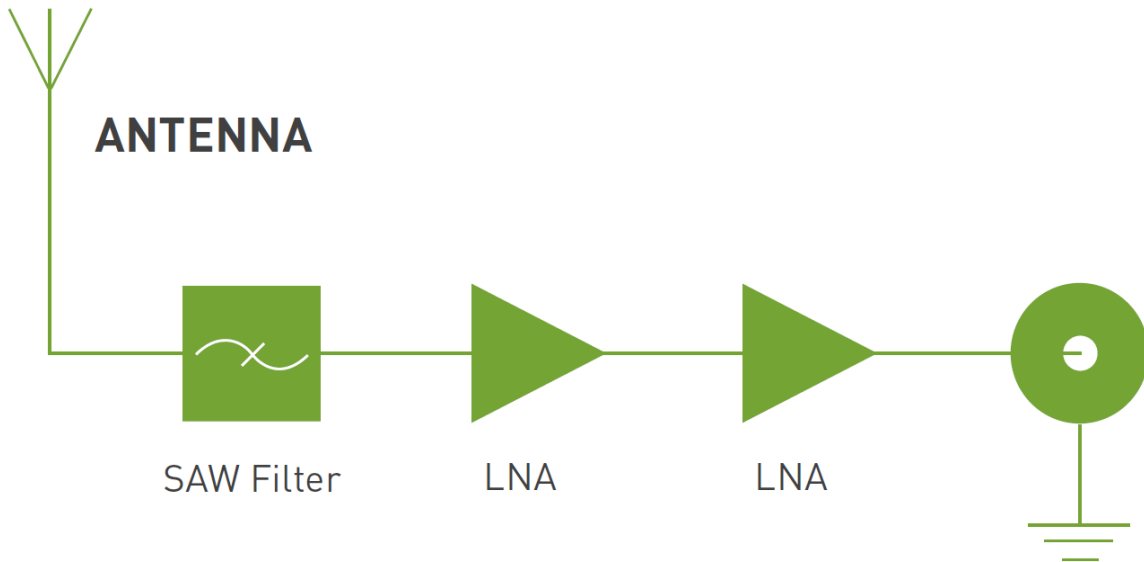

### 3.1.1 Return Loss

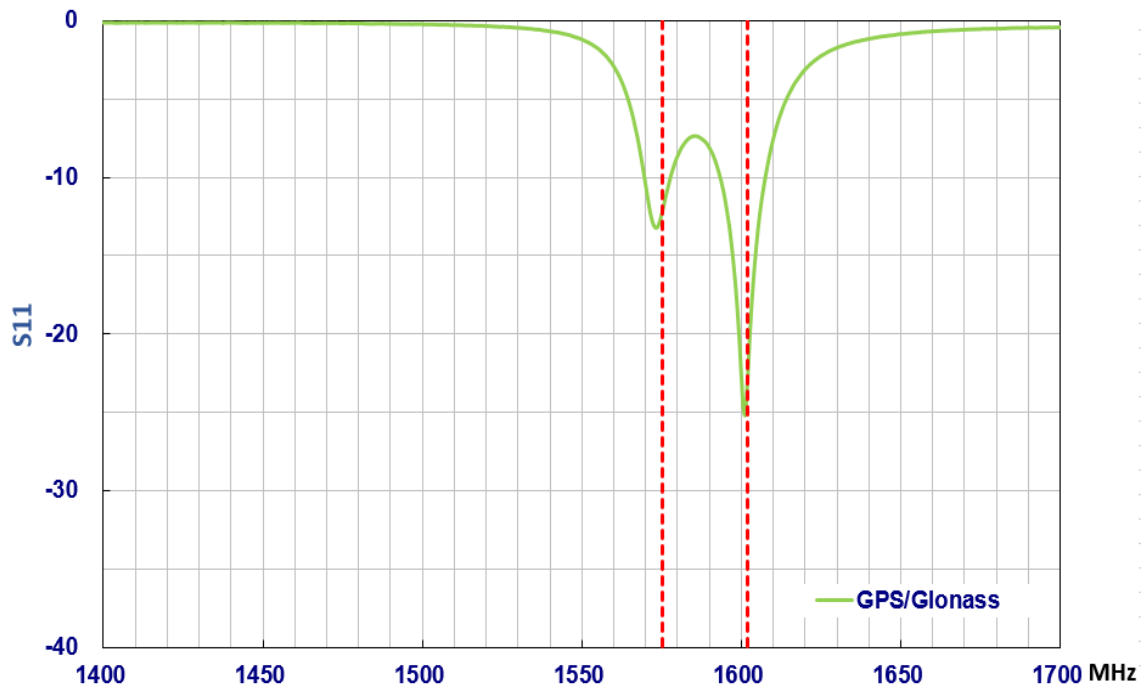

### 3.1.2 Out Band Rejection @3V

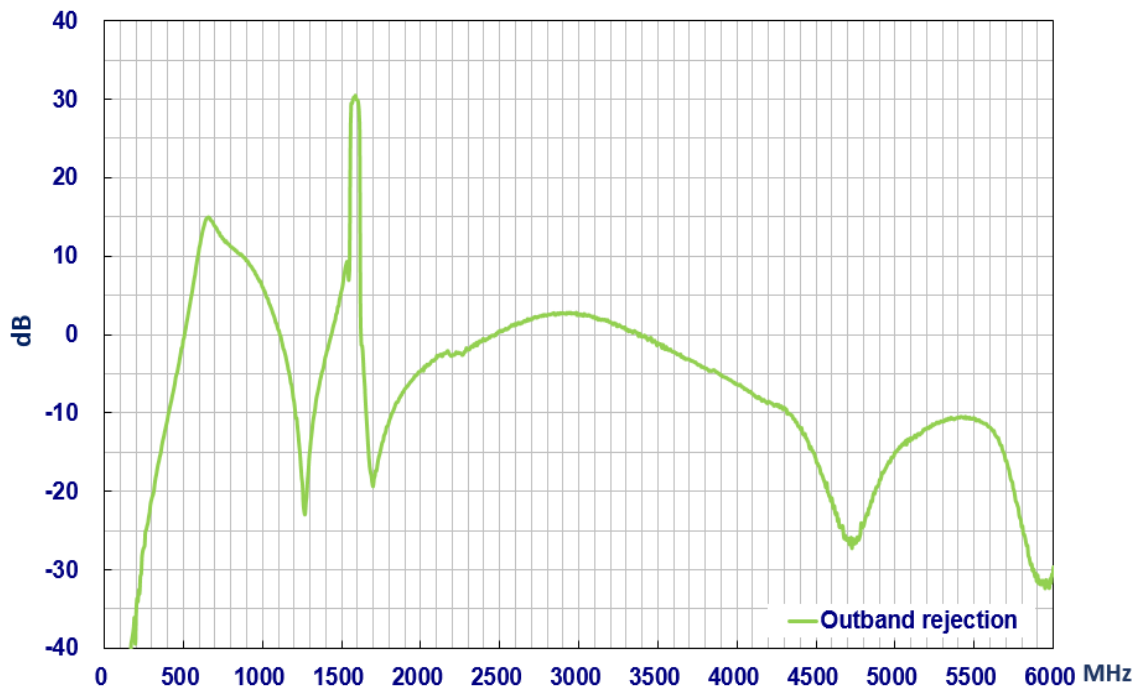



### 3.1.3 LNA Noise Figure and Gain @3V

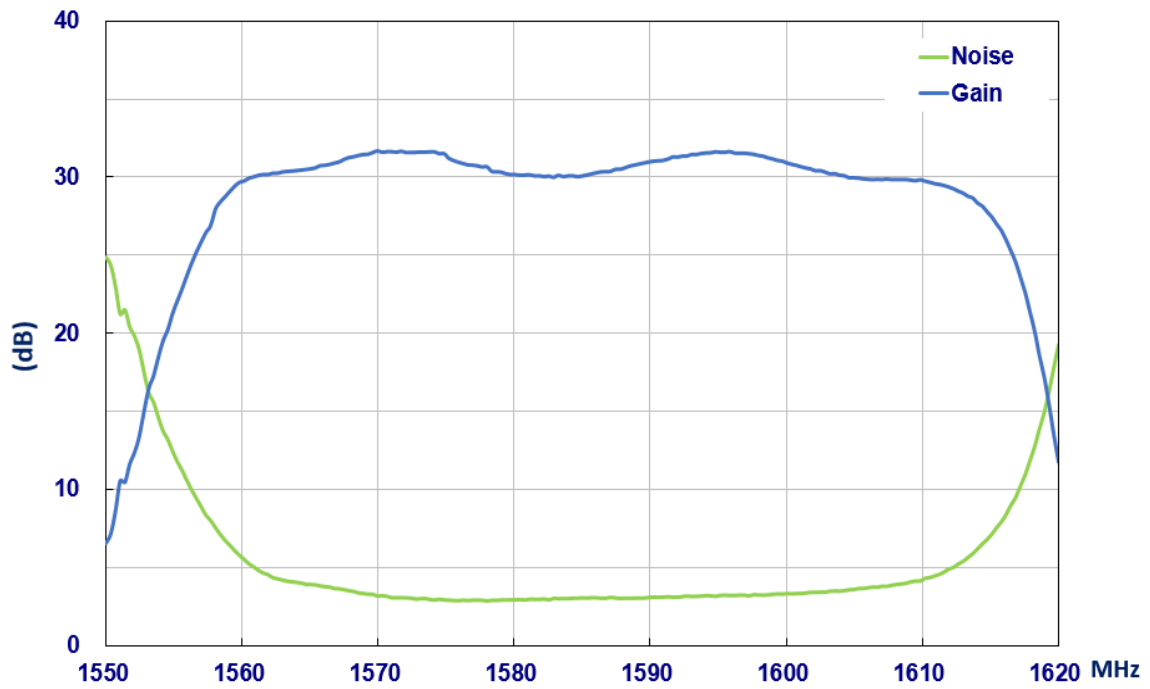

### 3.1.4 Efficiency

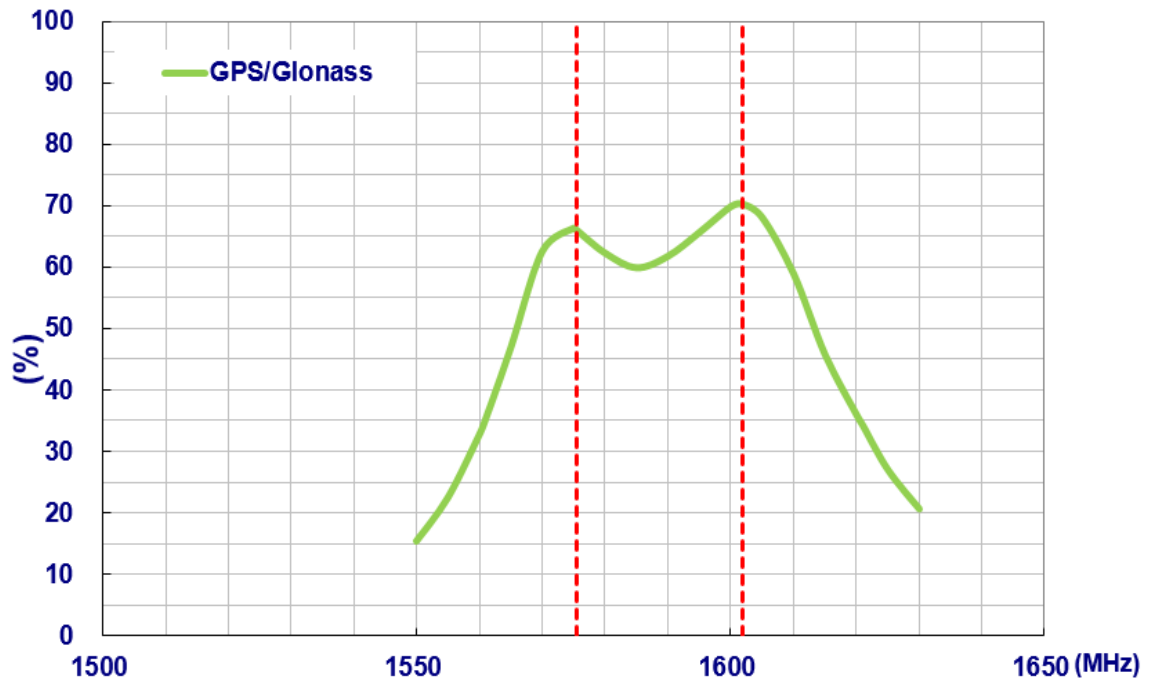

### 3.1.5 Average Gain

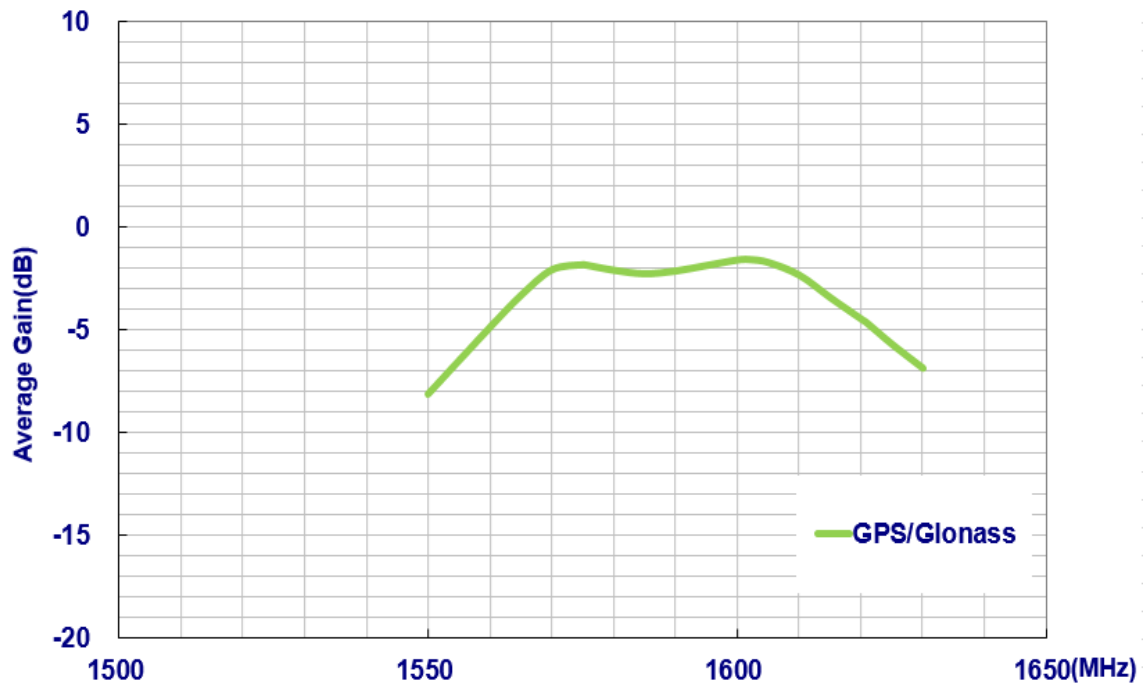

### 3.1.6 Peak Gain

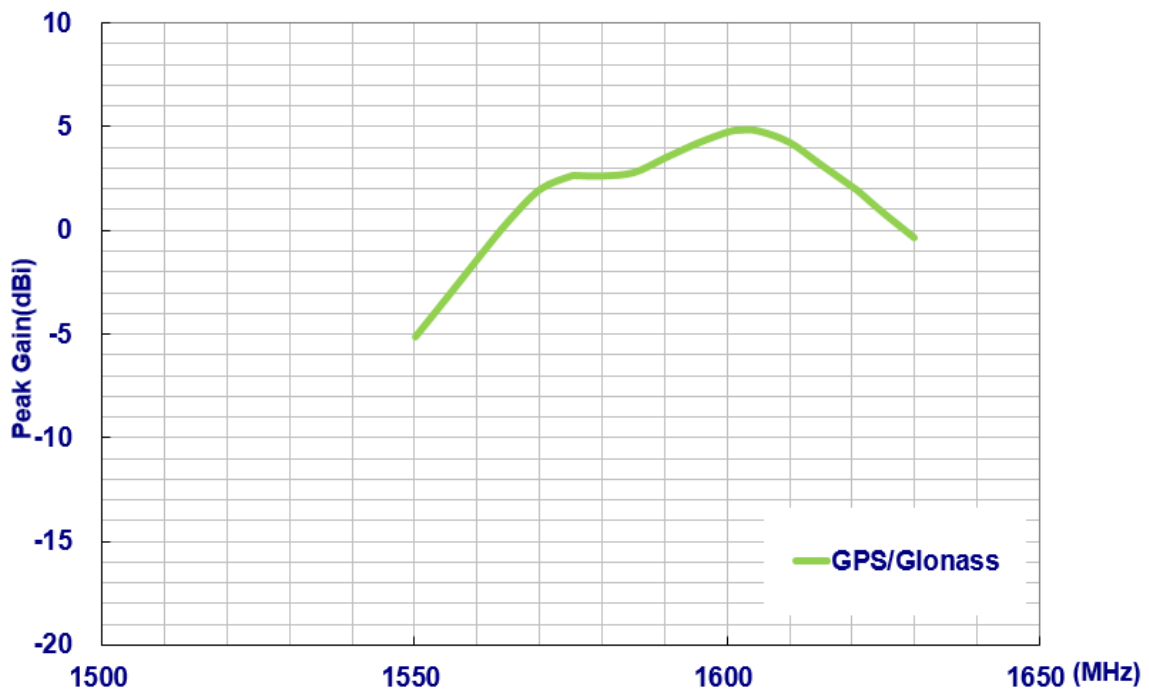

### 3.1.7 Axial Ratio

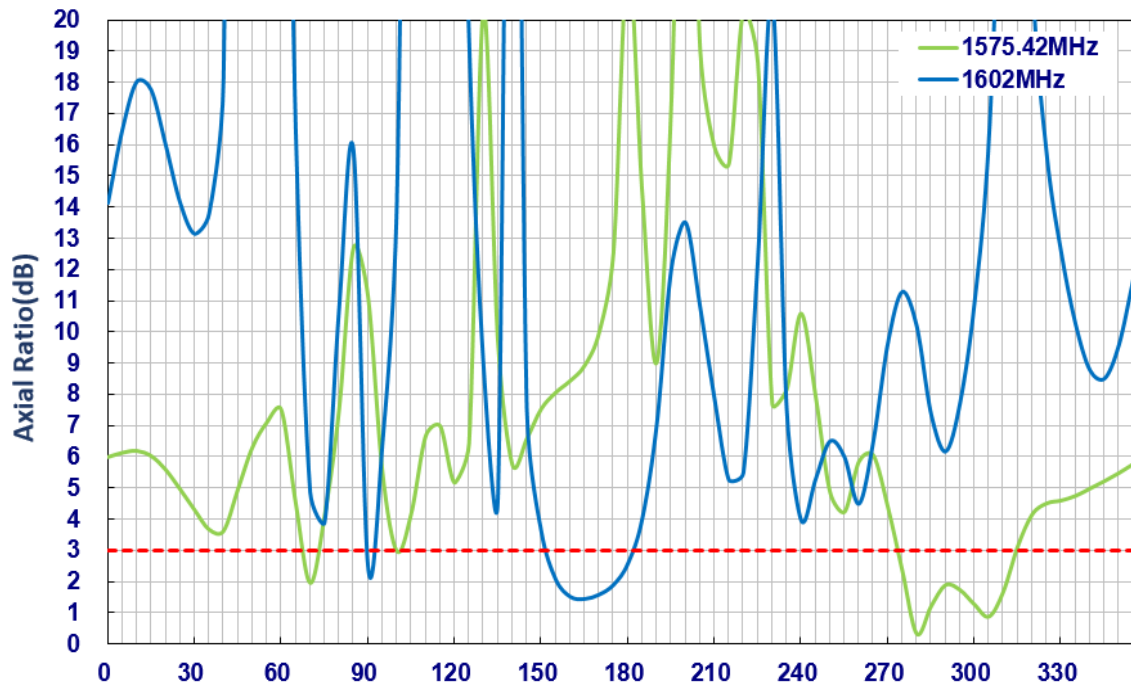

### 3.1.8 2D Radiation Patterns

#### XY Plane

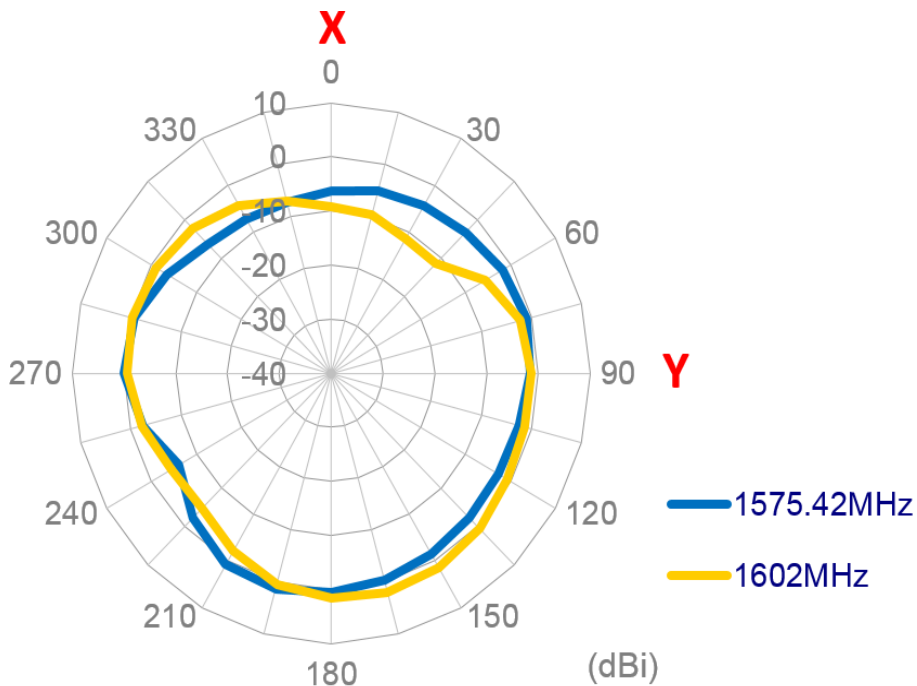

#### ZX Plane

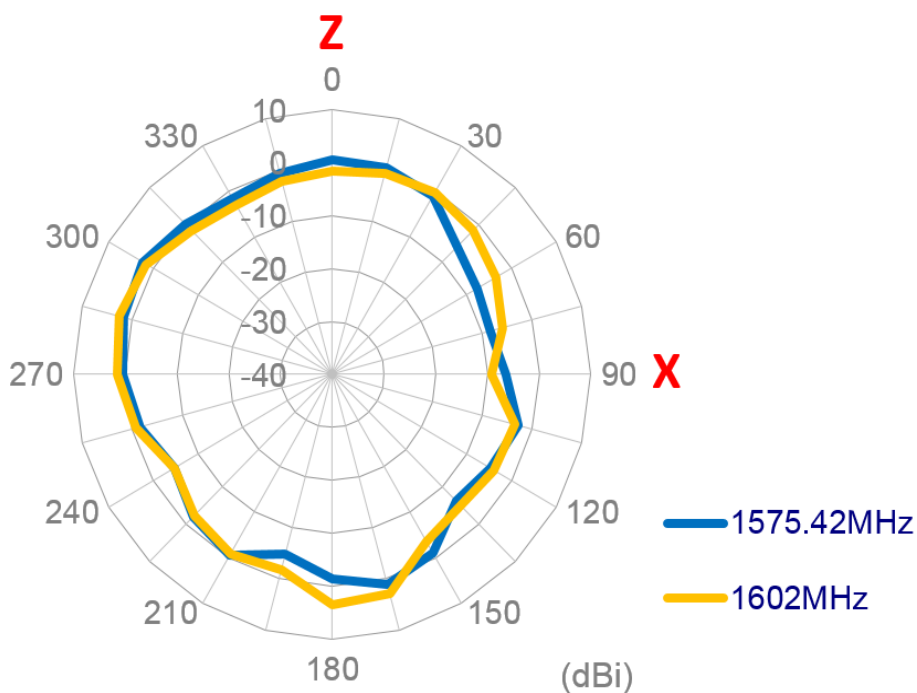

**ZY Plane**

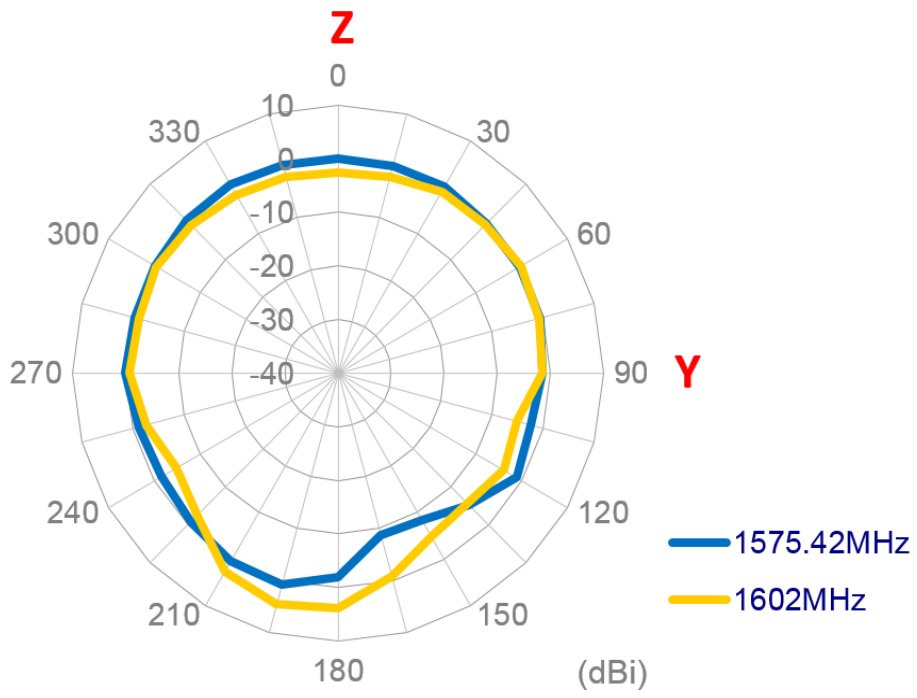

### 3.1.9 3D Radiation Patterns

1575.42MHz

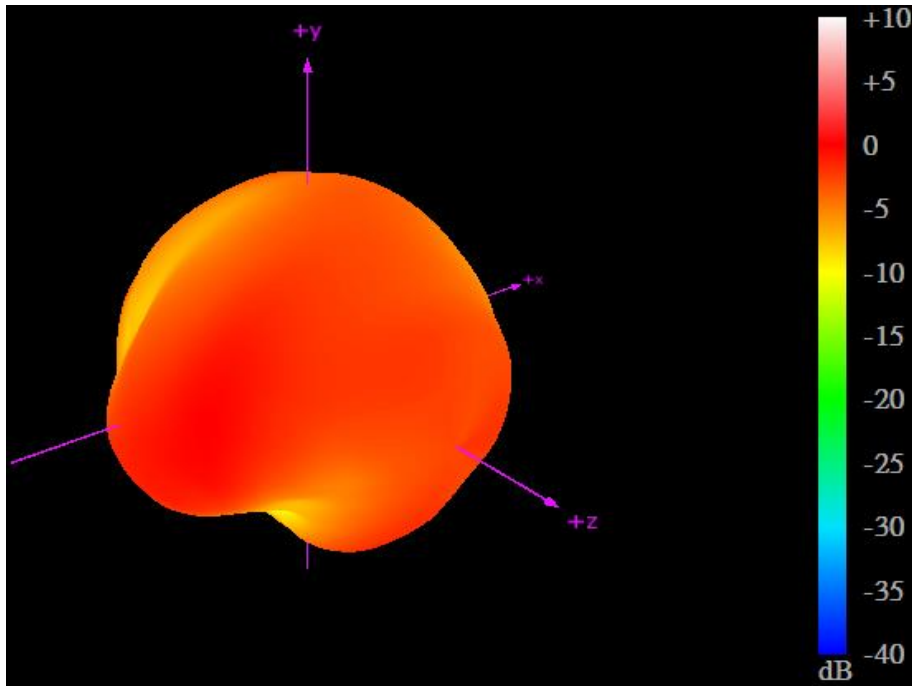

1602MHz

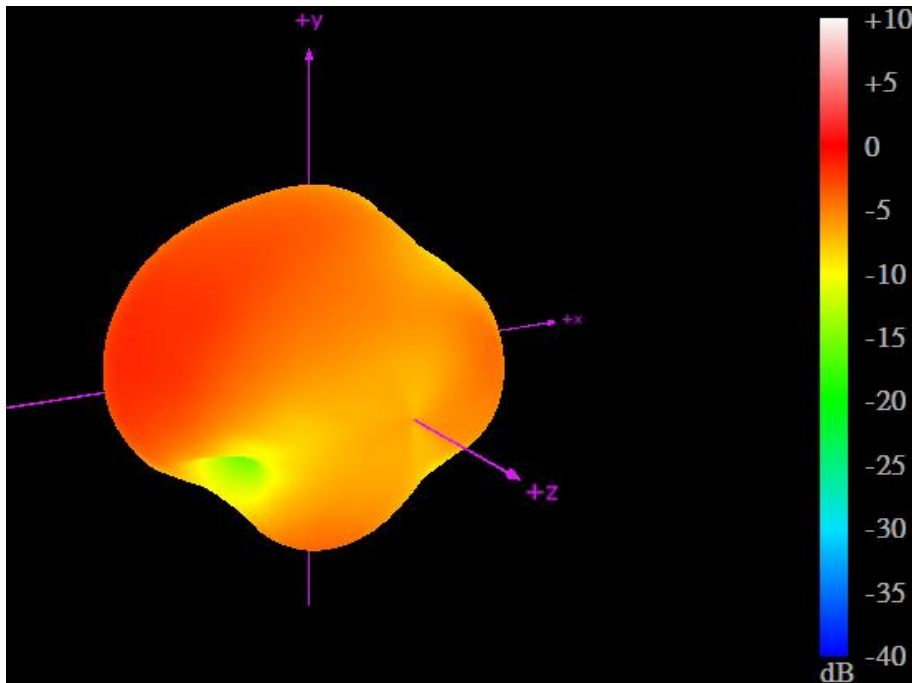

### 3.2 LTE & WIFI Antenna

#### 3.2.1 Return loss

##### LTE MIMO 1, 2, 3 and 4

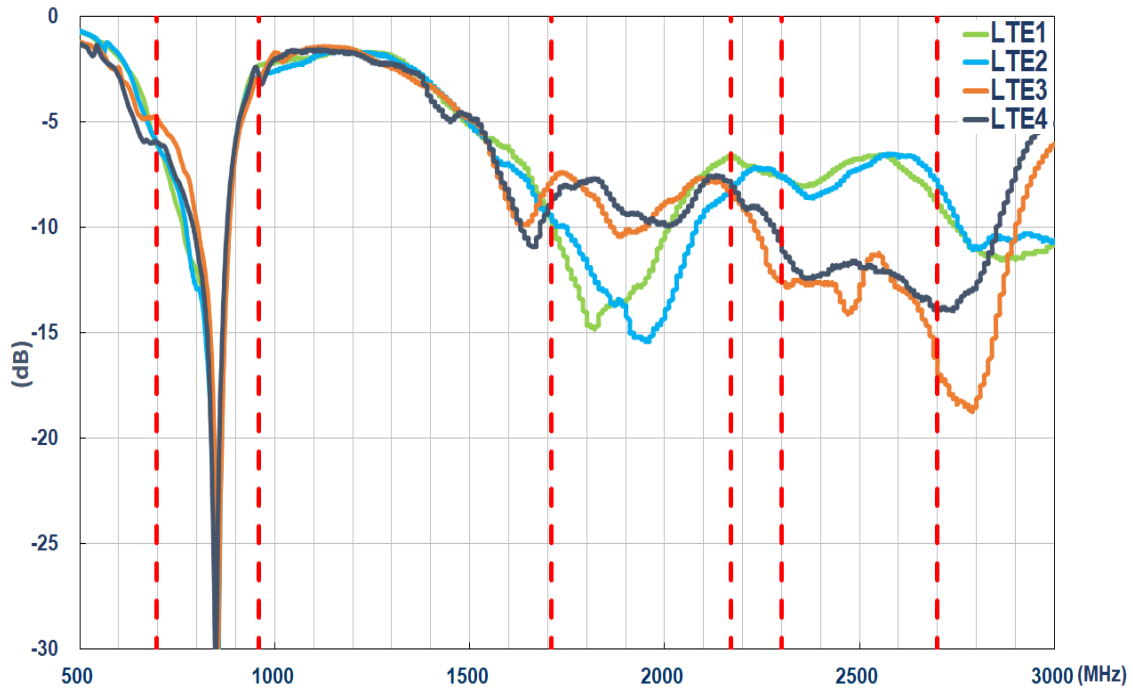

##### Wi-Fi MIMO 1, 2 and 3

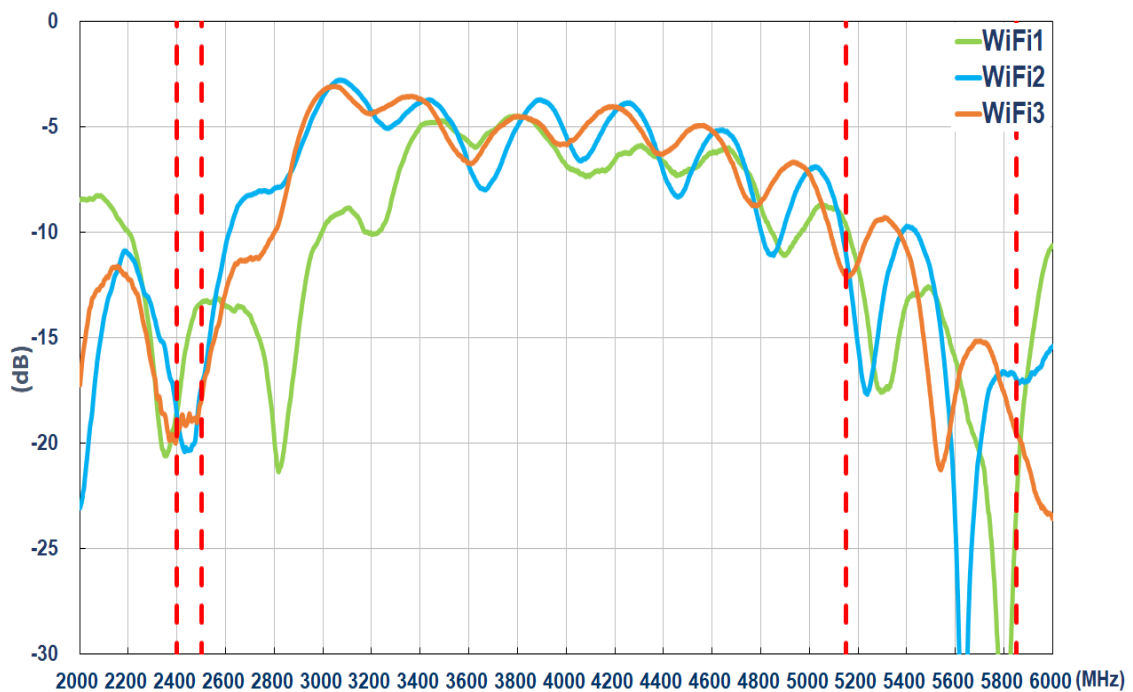

### 3.2.2 Isolation

#### LTE MIMO 1, 2, 3 and 4

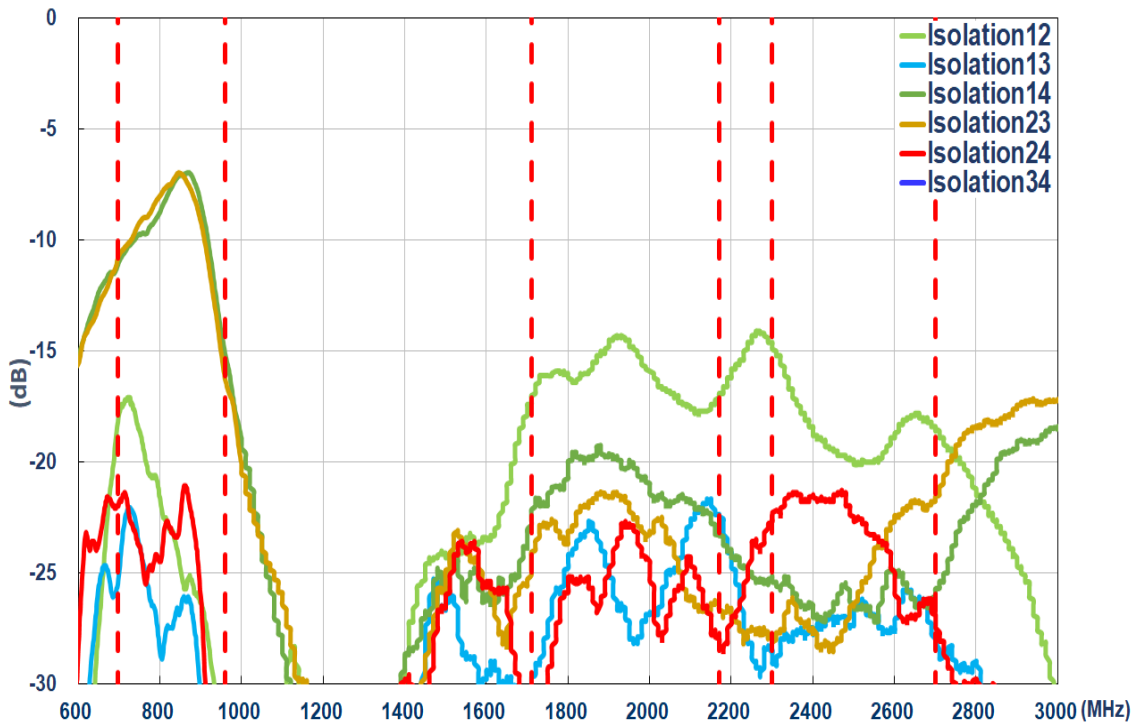

#### Wi-Fi MIMO 1, 2 and 3

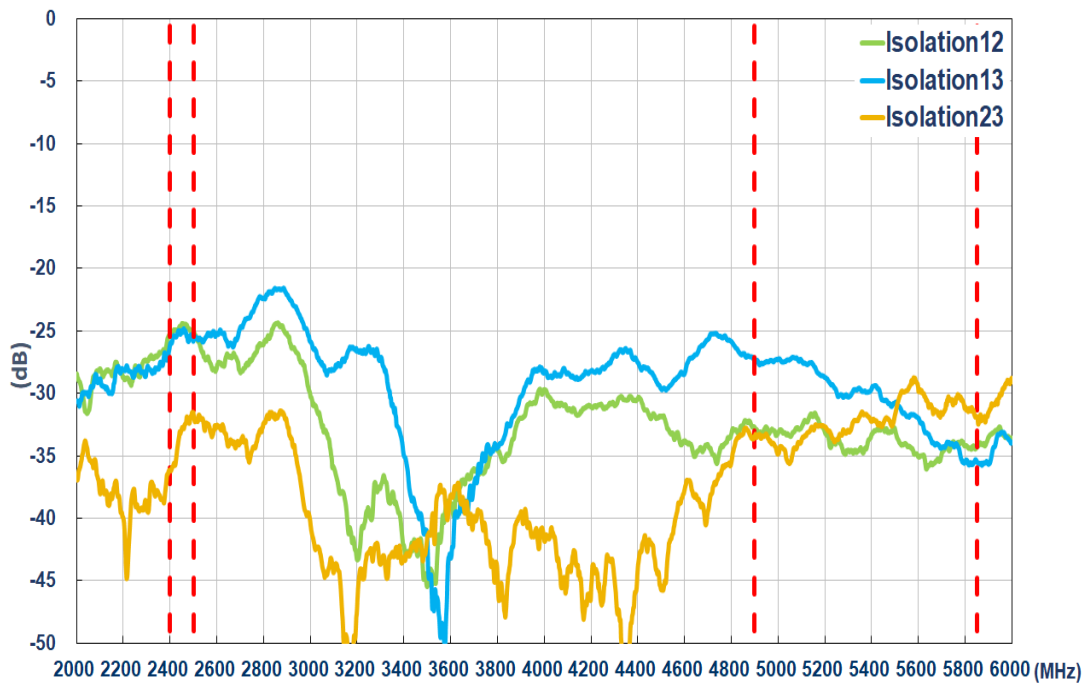



### 3.2.3 Efficiency

#### LTE MIMO 1, 2, 3 and 4

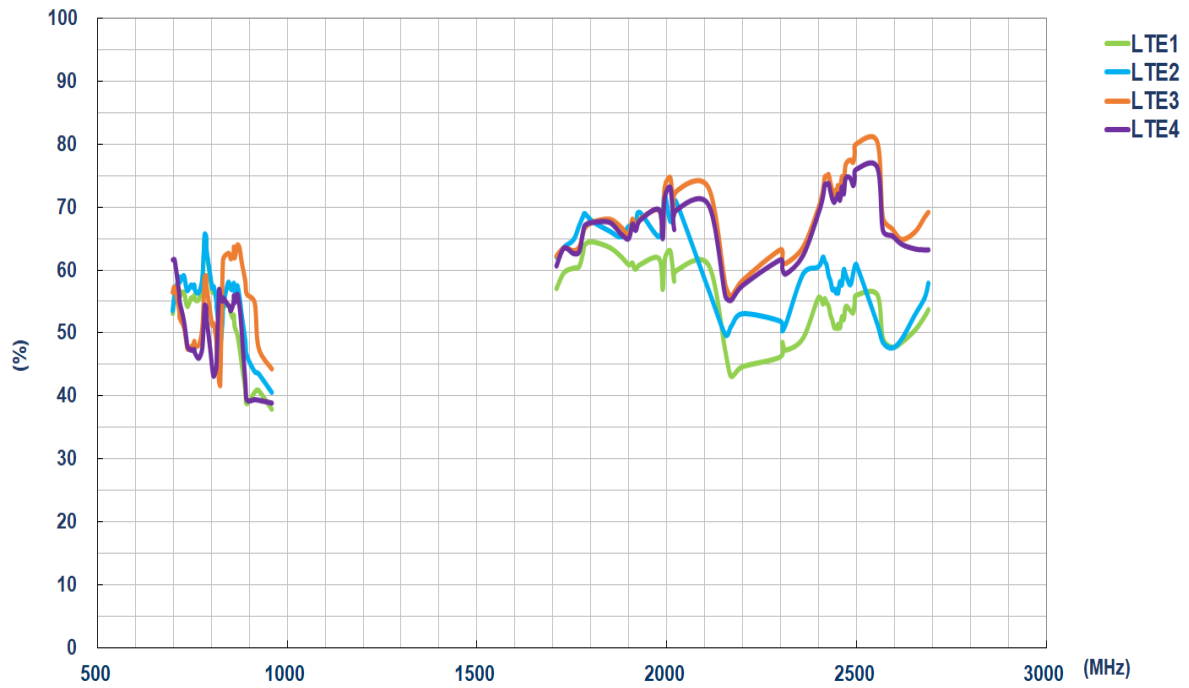

#### Wi-Fi MIMO 1, 2 and 3

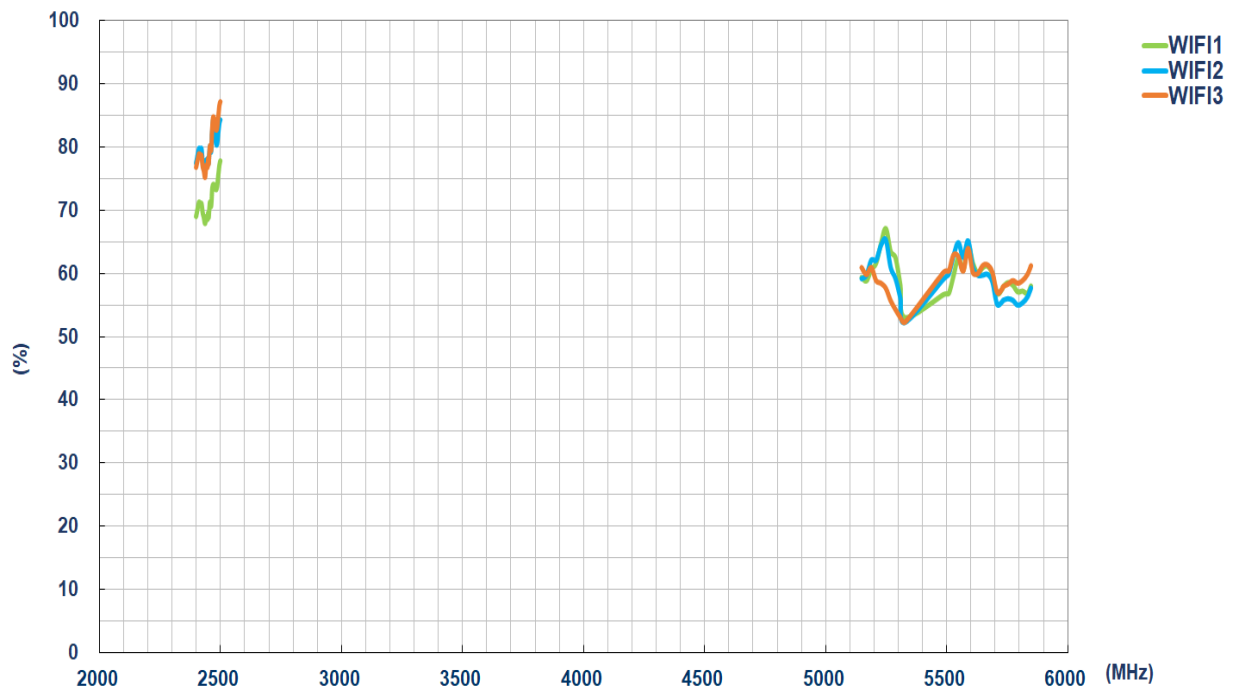

### 3.2.4 Average Gain

#### LTE MIMO 1, 2, 3 and 4

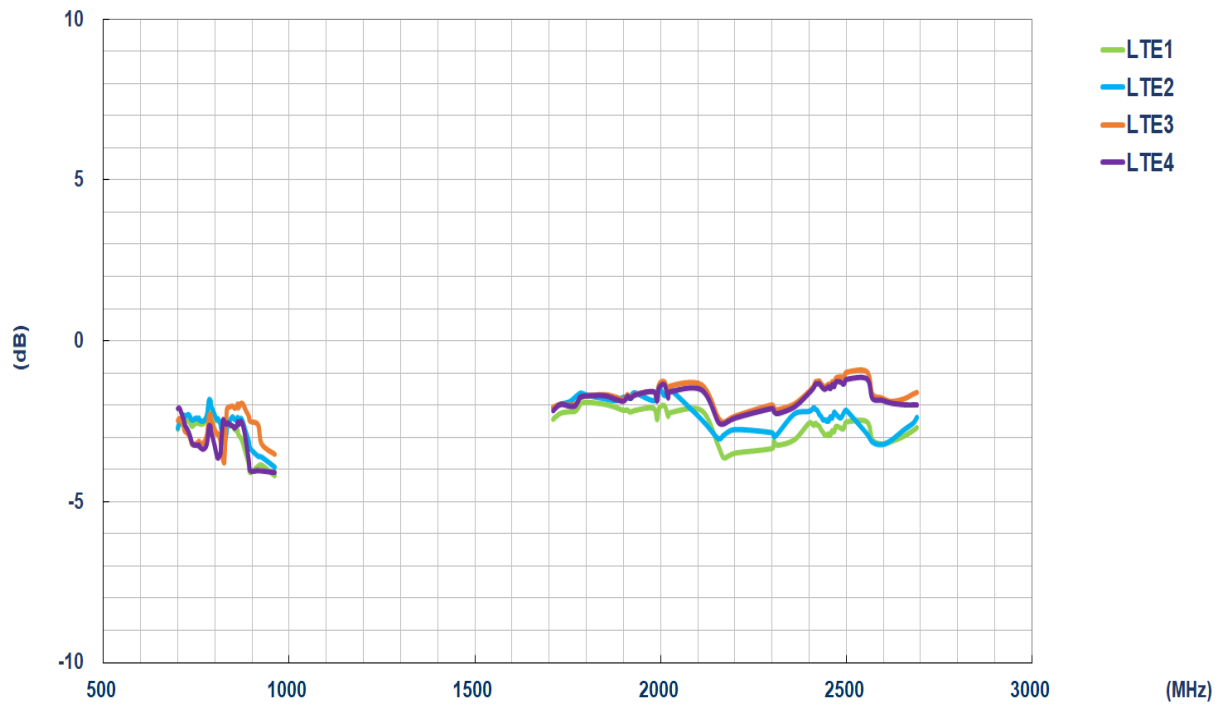

#### Wi-Fi MIMO 1, 2 and 3

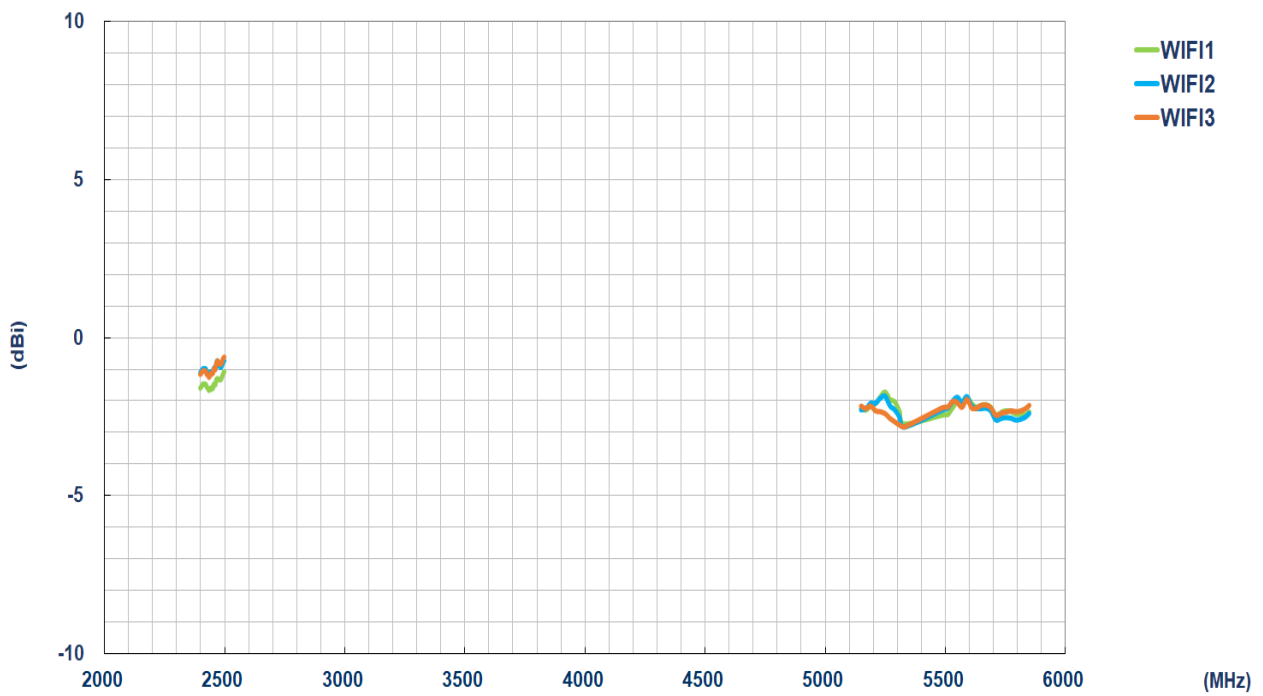

### 3.2.4.1 Peak Gain

#### LTE

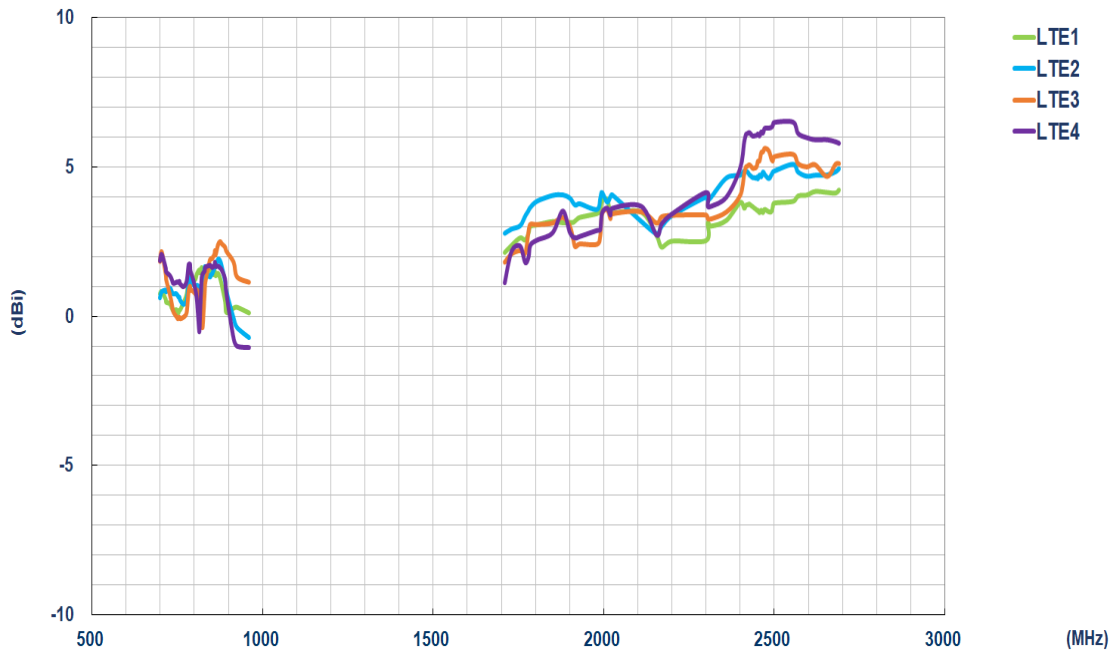

#### WIFI

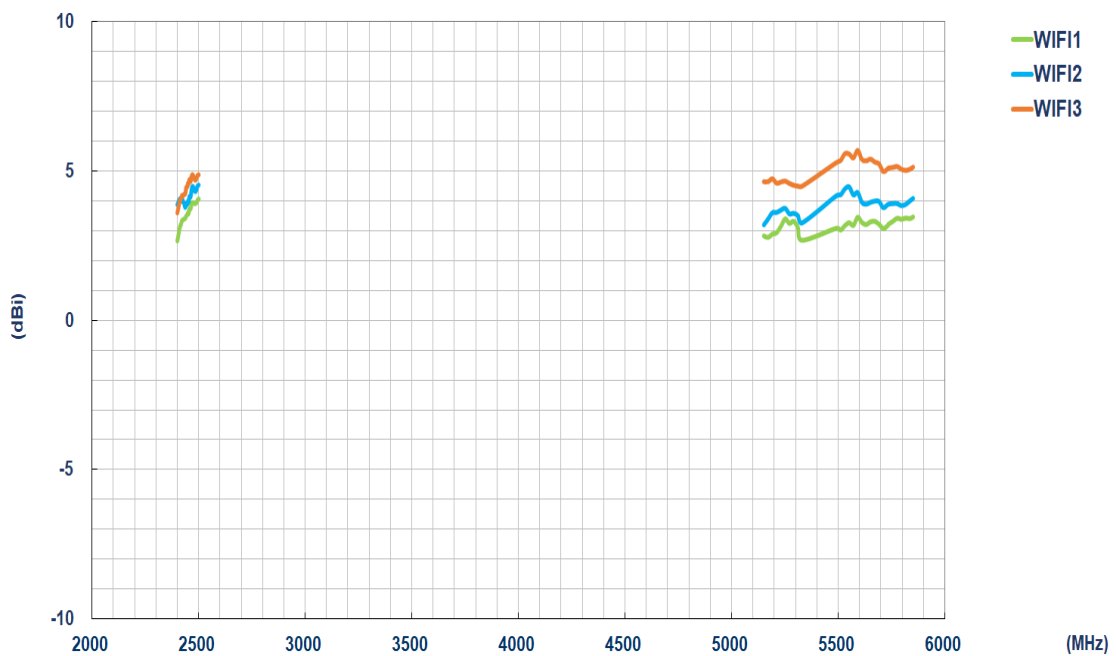

## 4. Antenna Radiation Patterns

### 4.1 Antenna Setup (Antenna Test Setup in Anechoic Chamber)

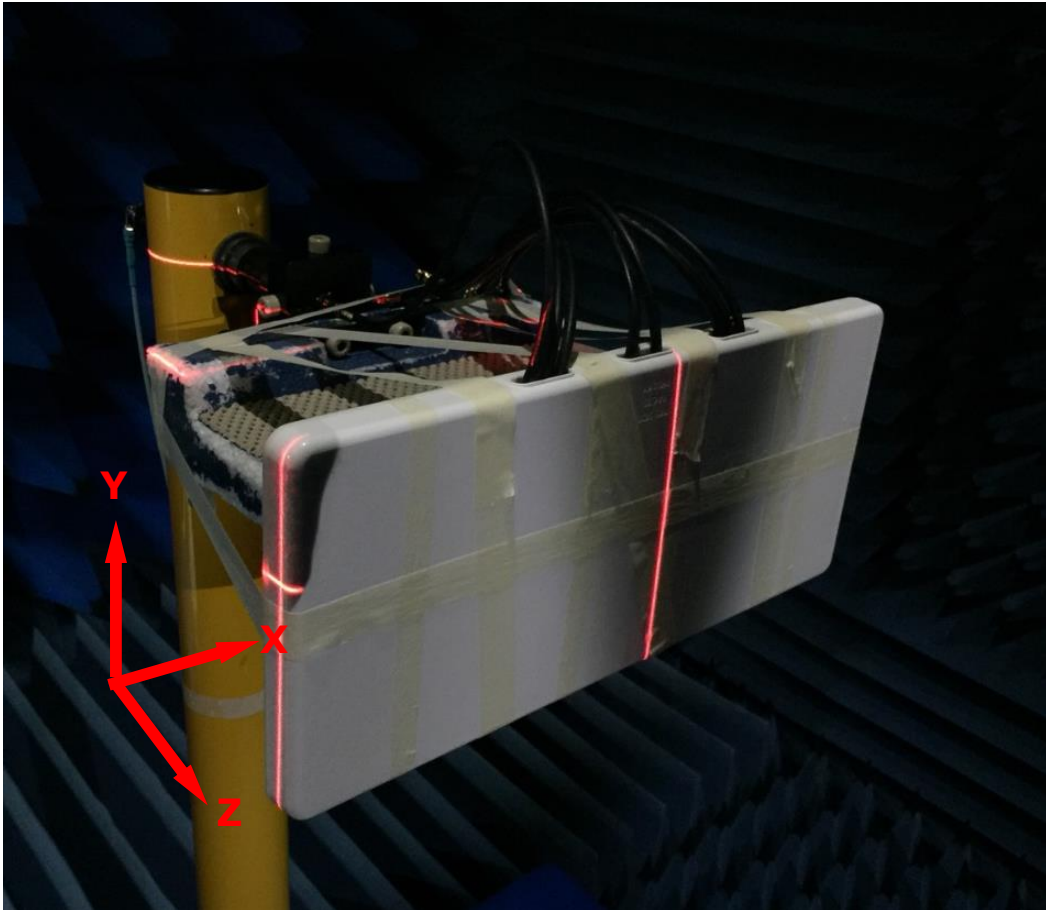

## 4.2 2D Radiation Patterns

### 4.2.1 LTE\_MIMO1

#### XY Plane

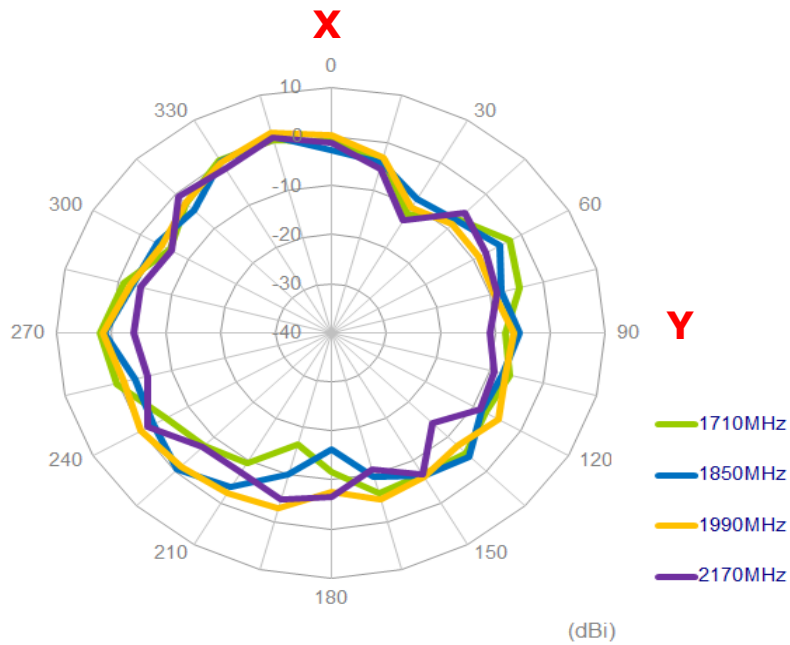
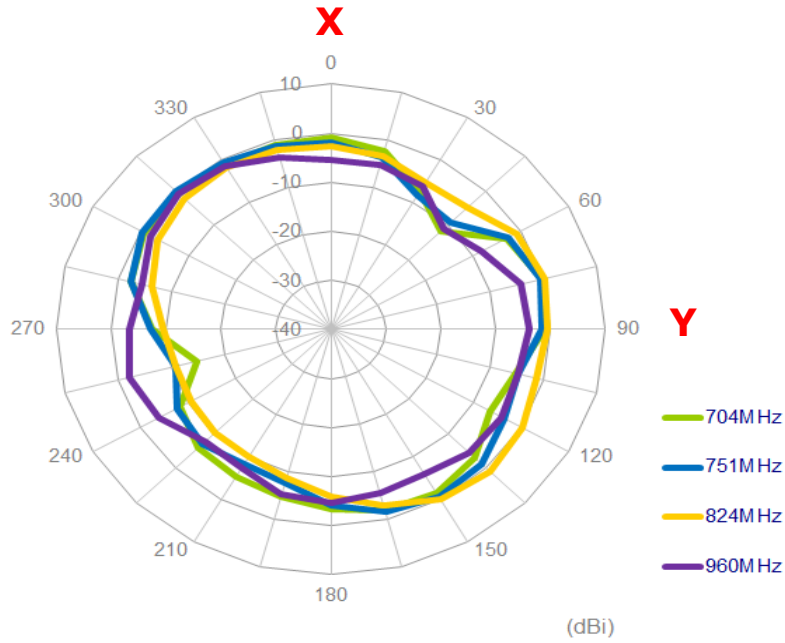

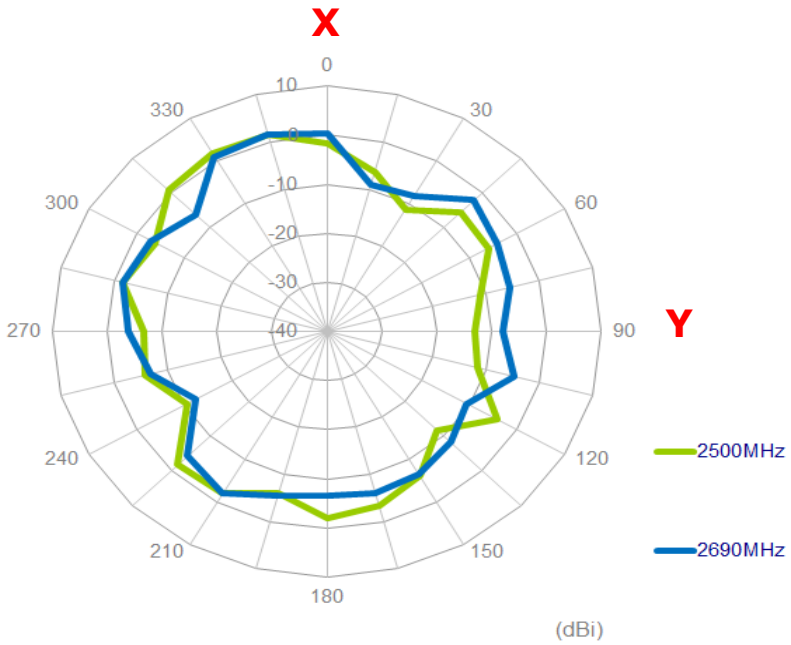

**XZ Plane**

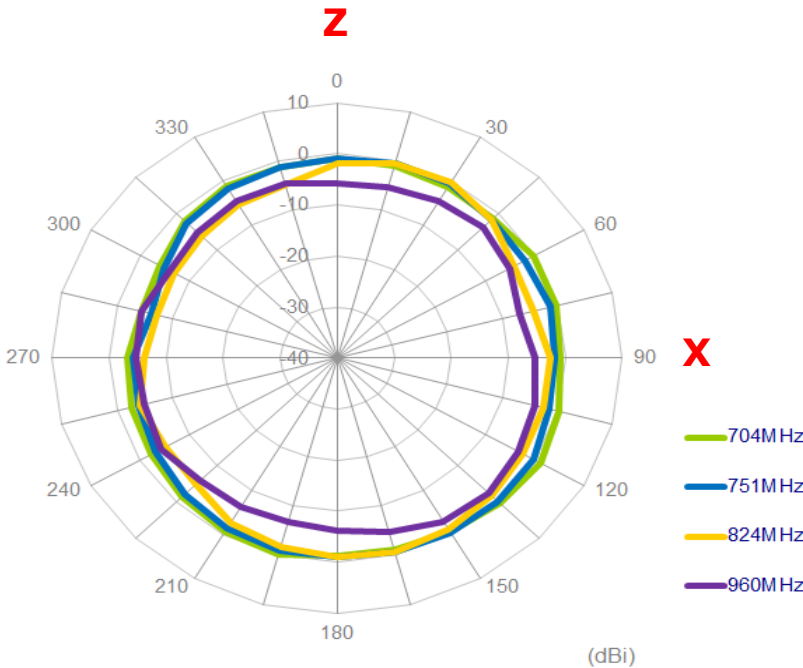

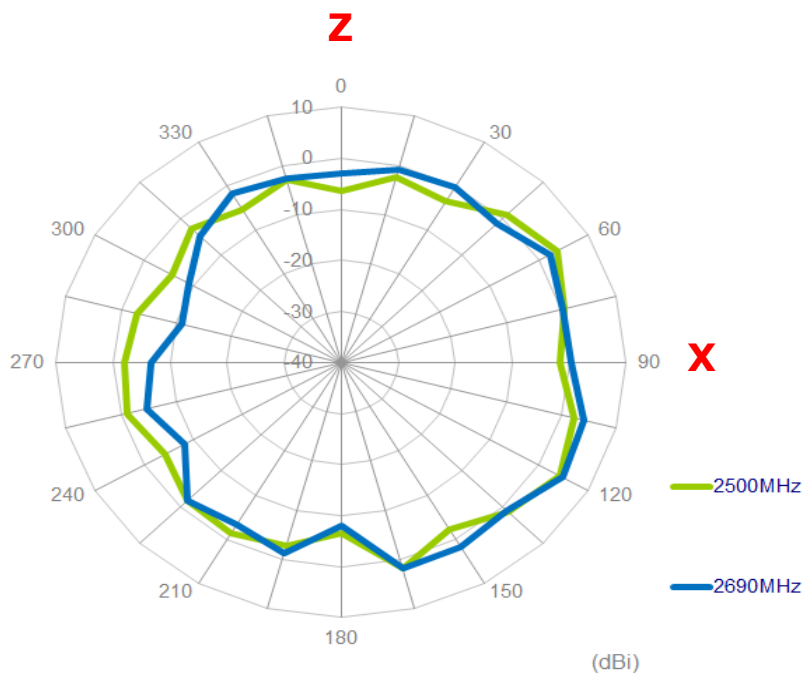
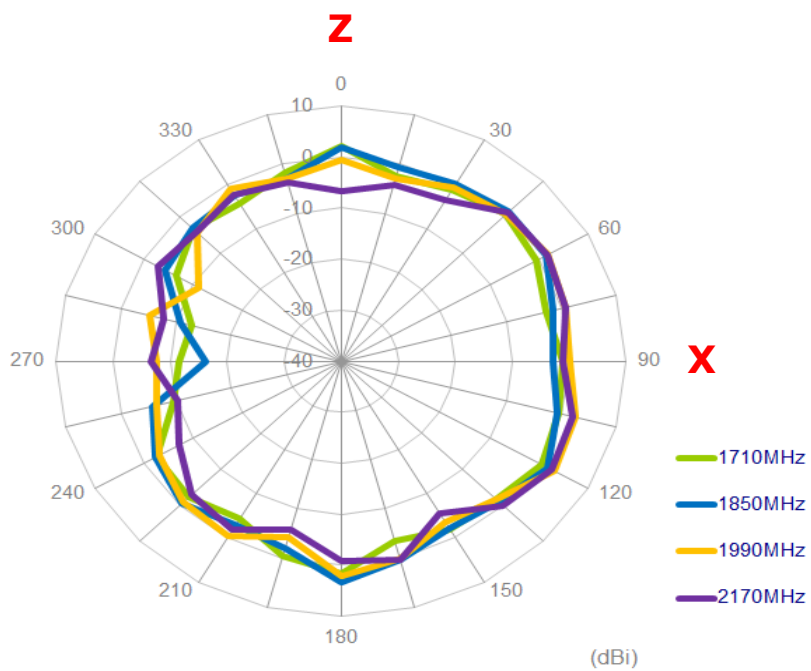

**YZ Plane**

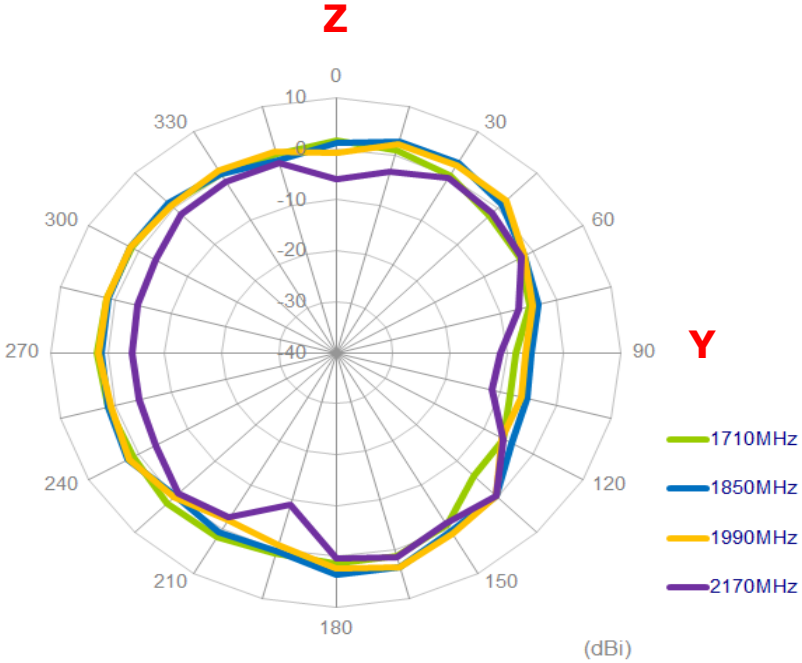
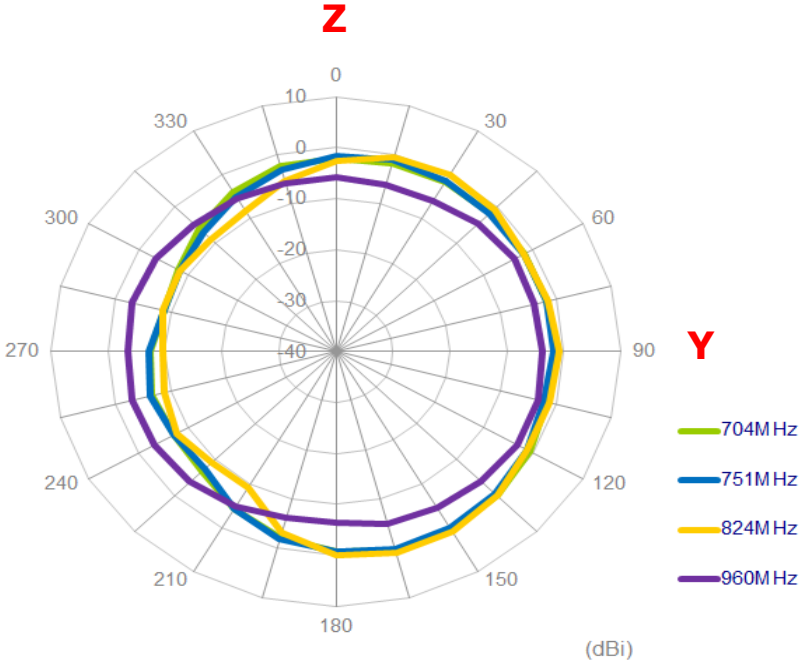



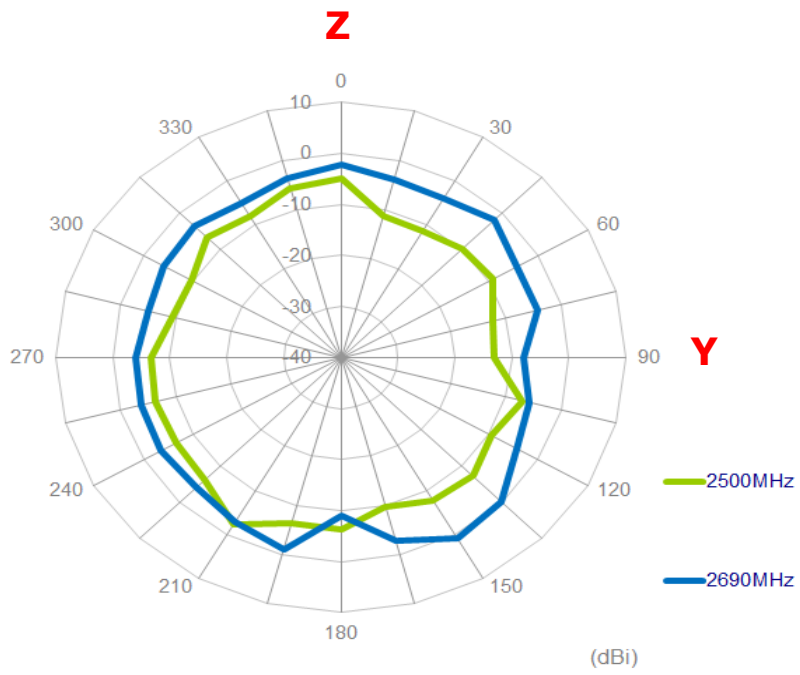

### 4.2.2 LTE\_MIMO2

#### XY Plane

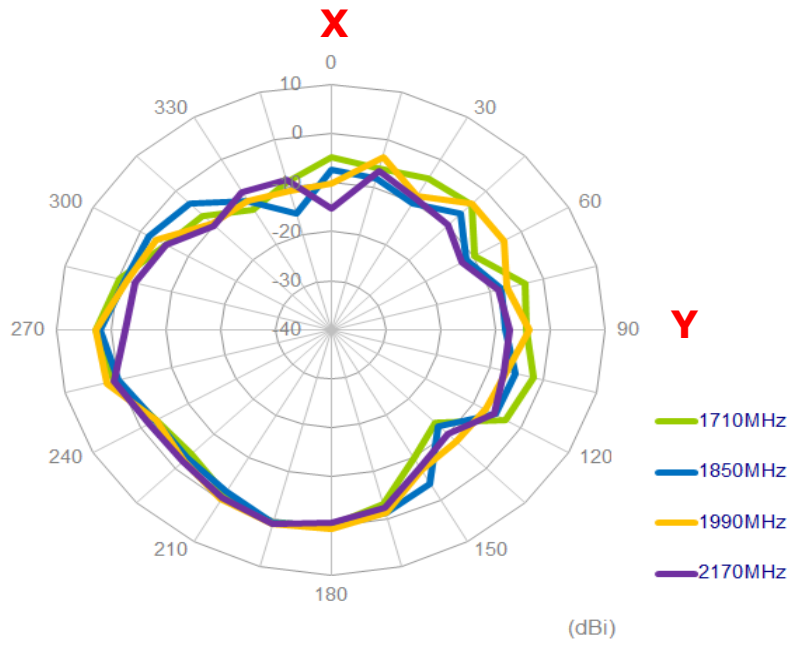
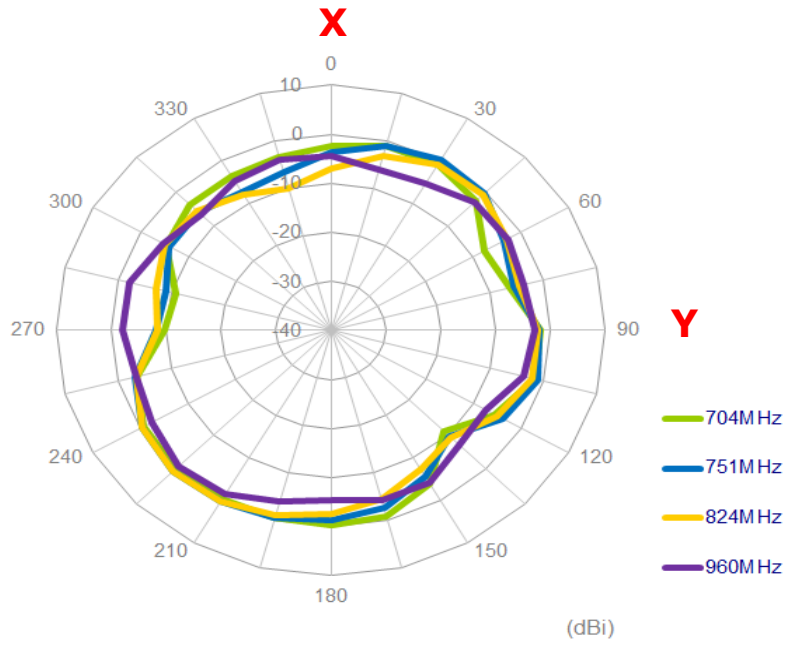

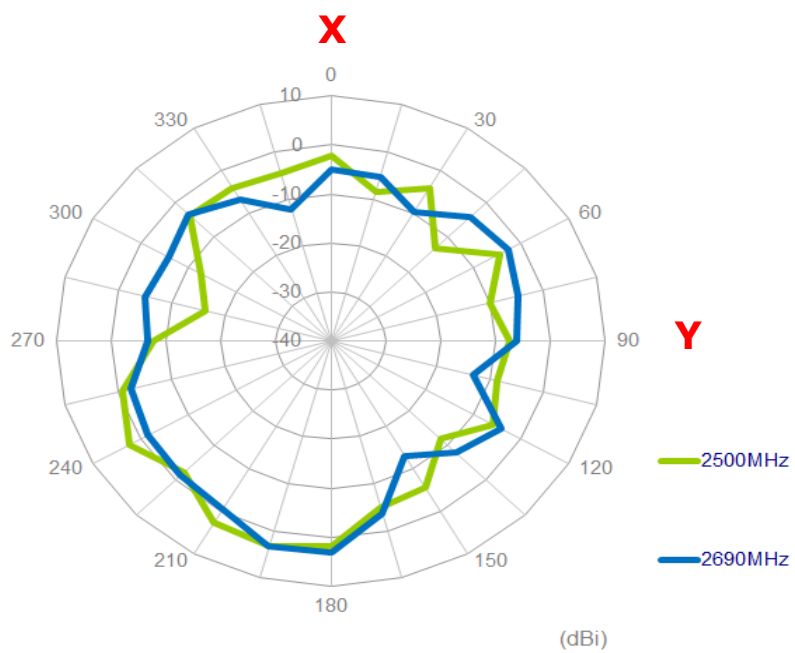

**XZ Plane**

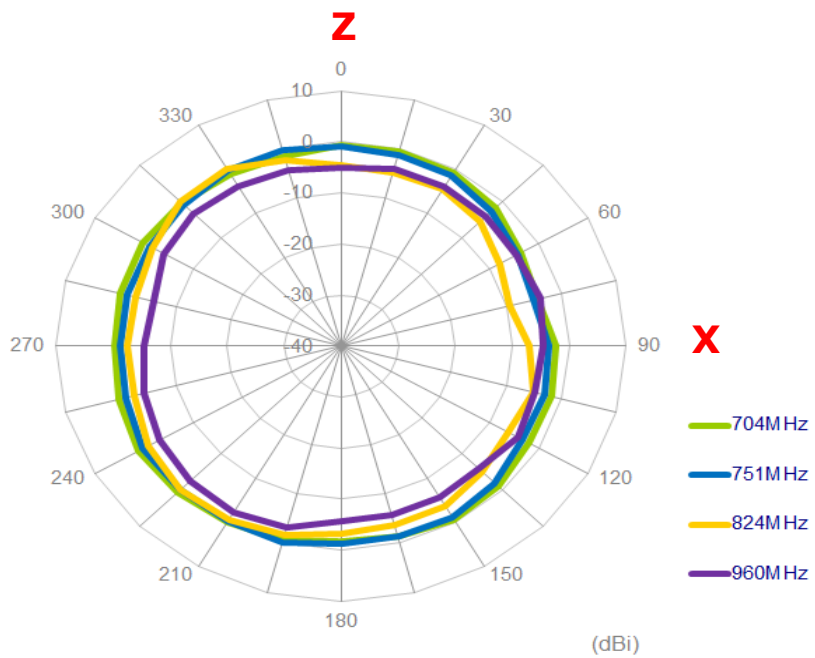

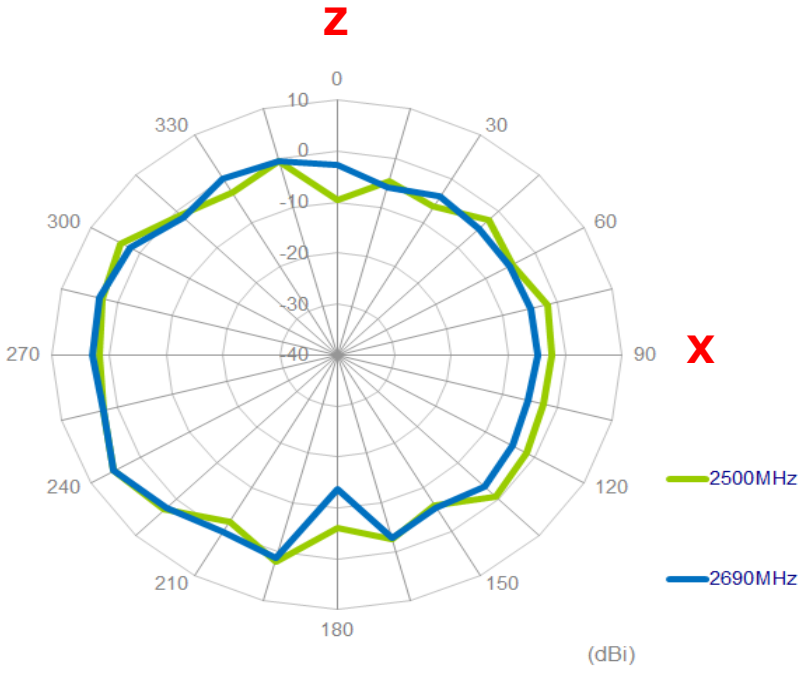
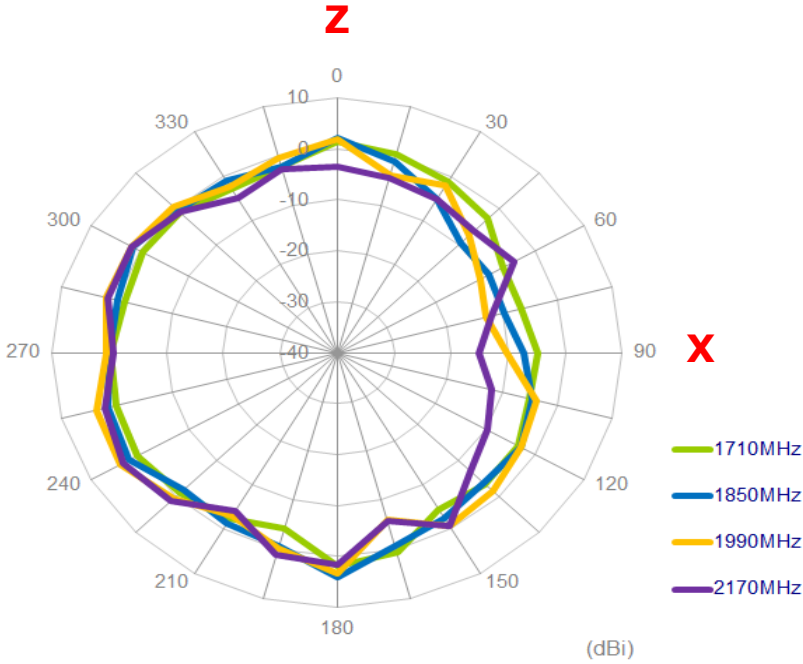

# YZ Plane

**Z**

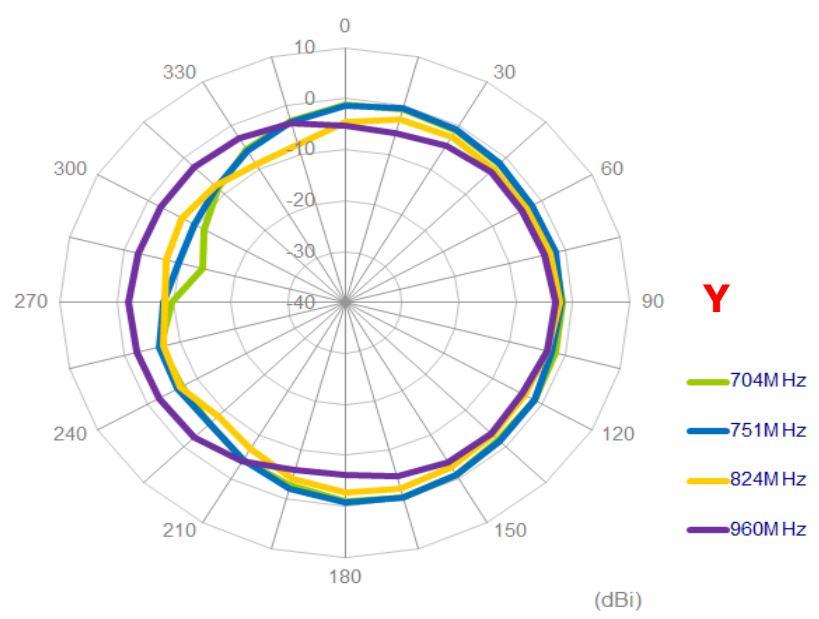

**Z**

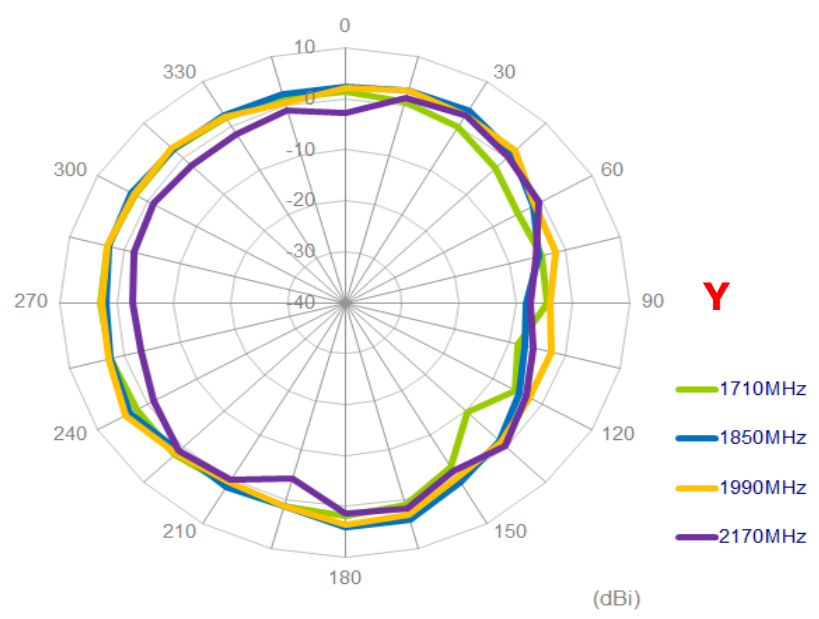

**Z**

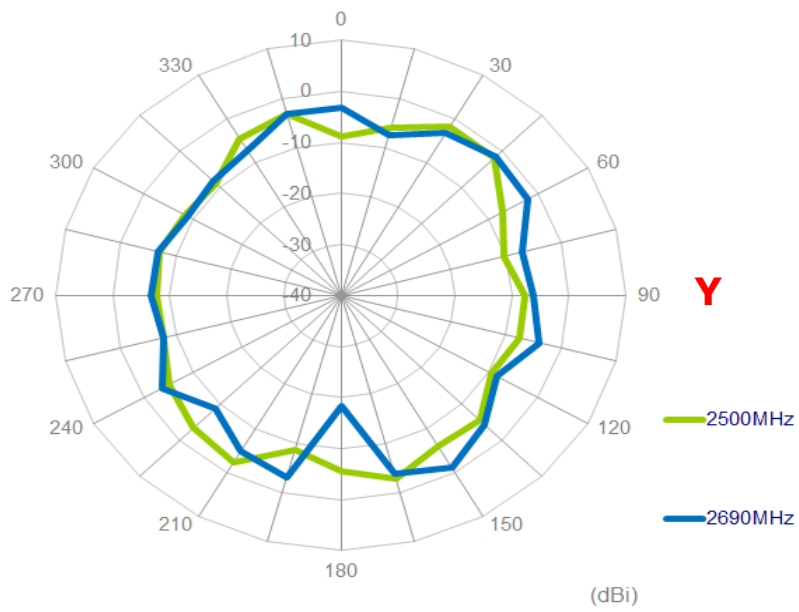

### 4.2.3 LTE\_MIMO3

#### XY Plane

**X**

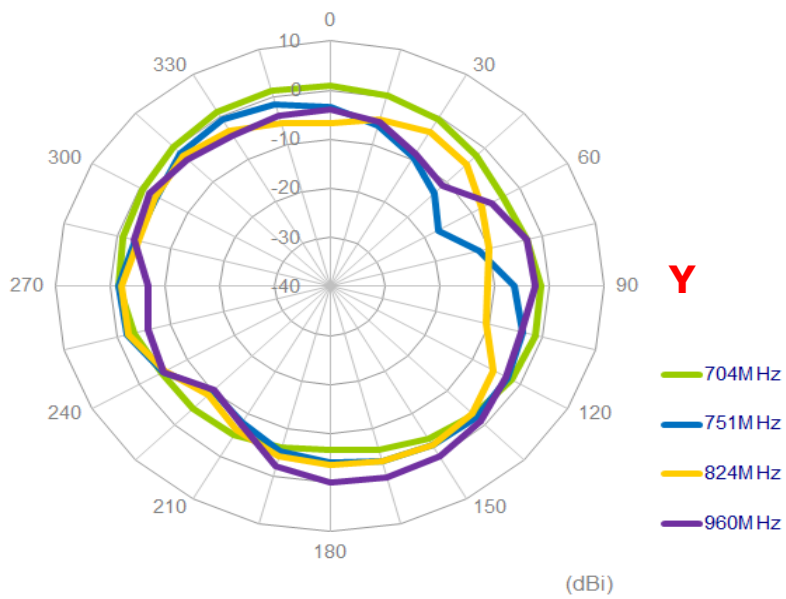

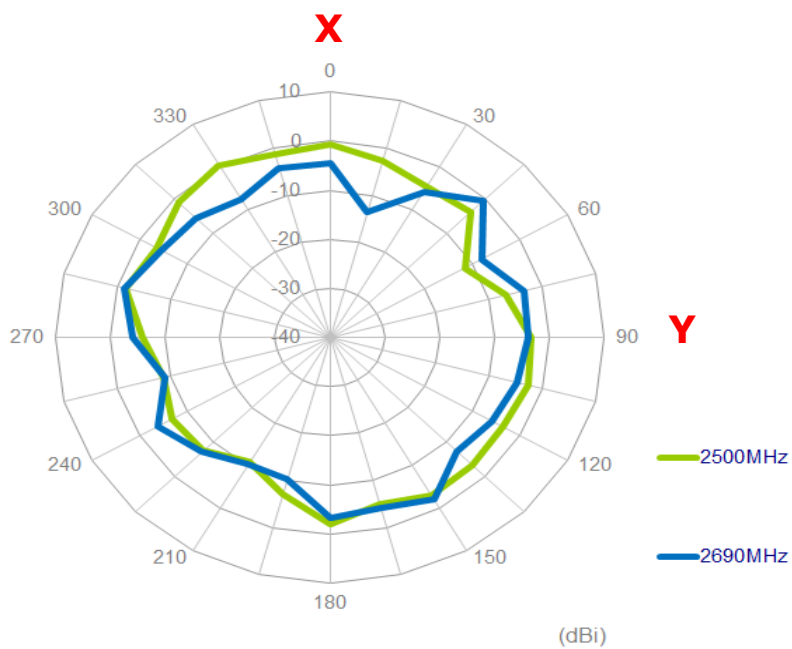
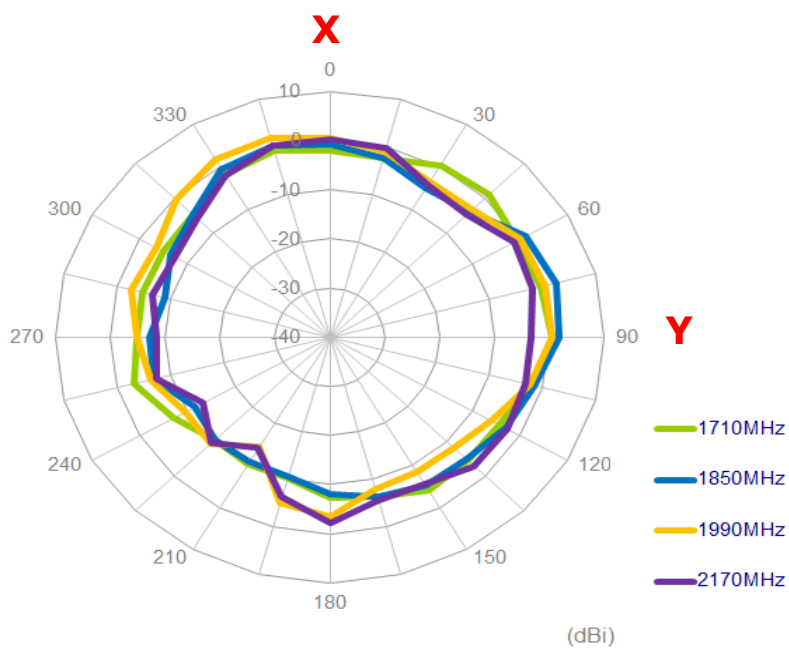

## XZ Plane

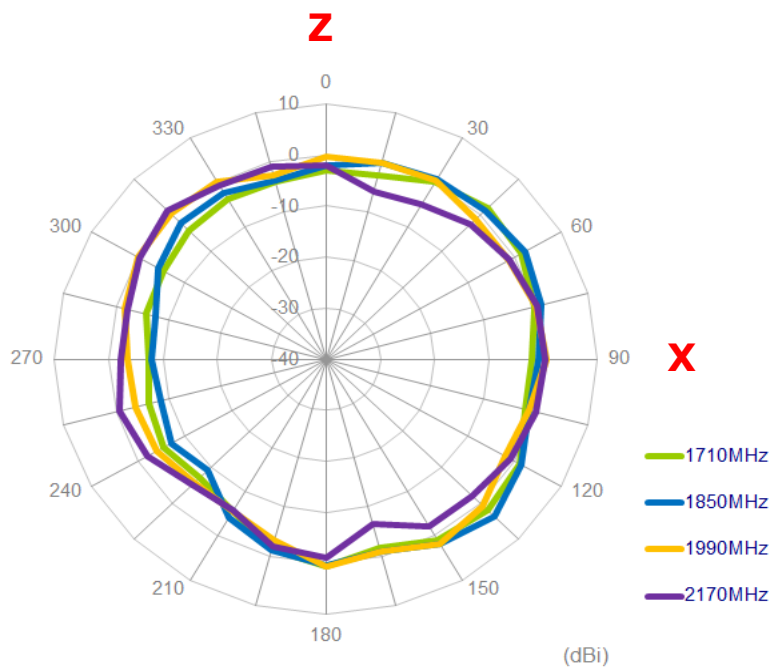
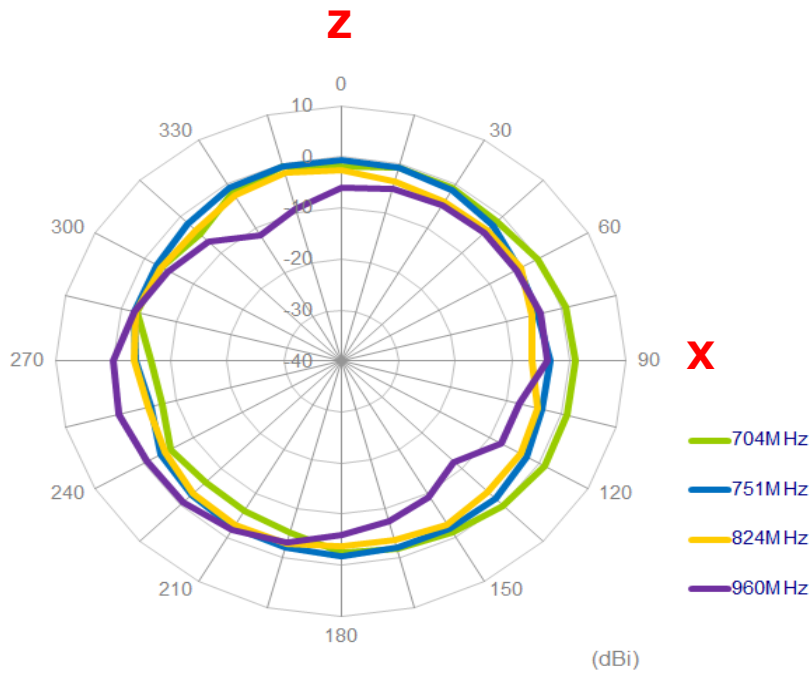



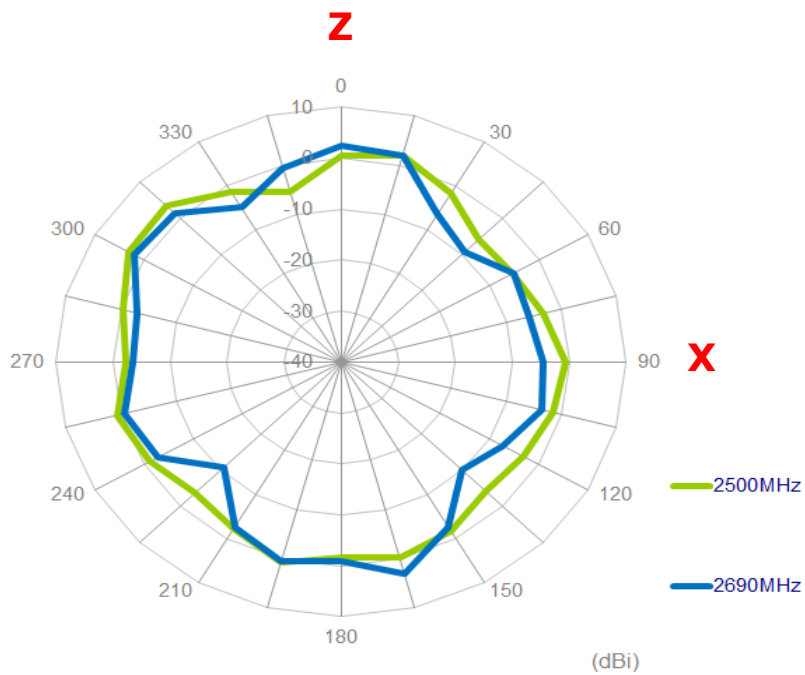

**YZ Plane**

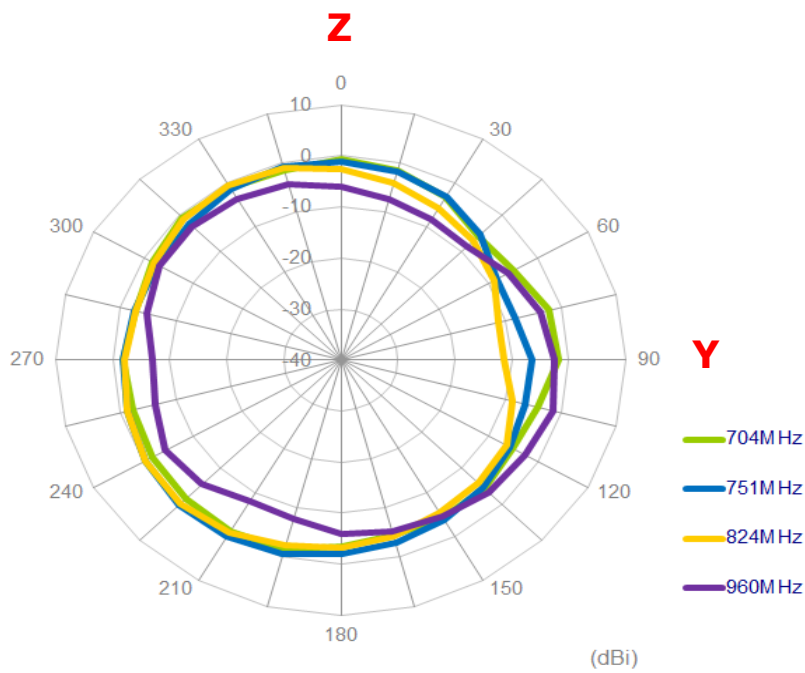

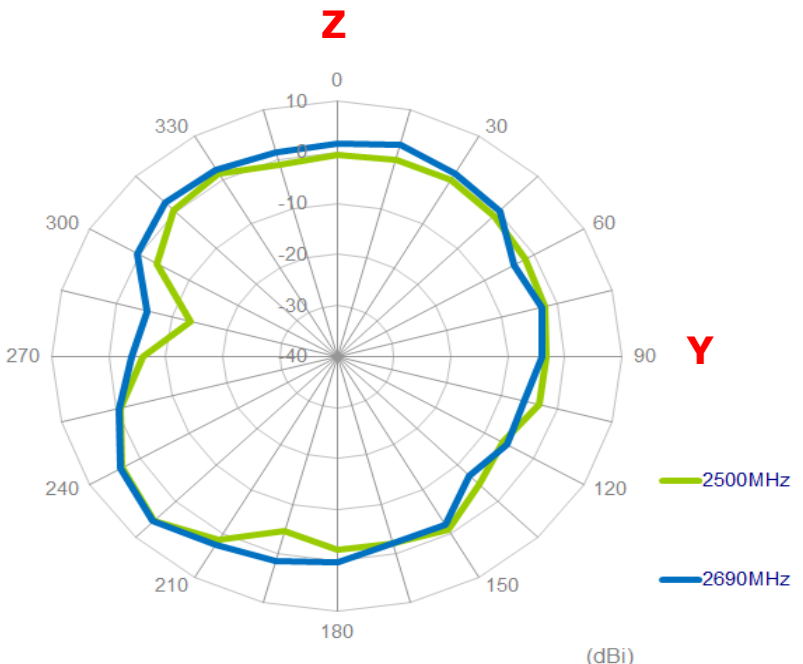
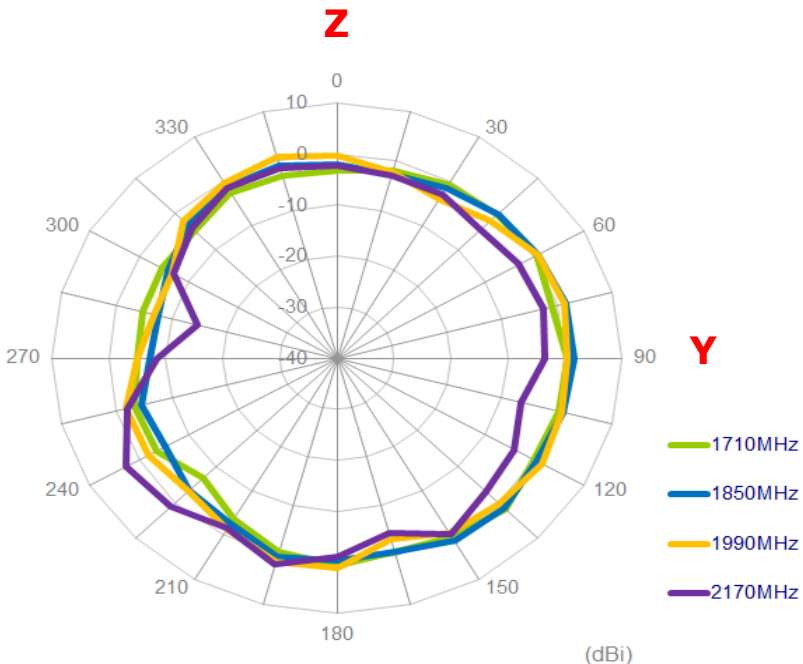

### 4.2.4 LTE\_MIMO4

#### XY Plane

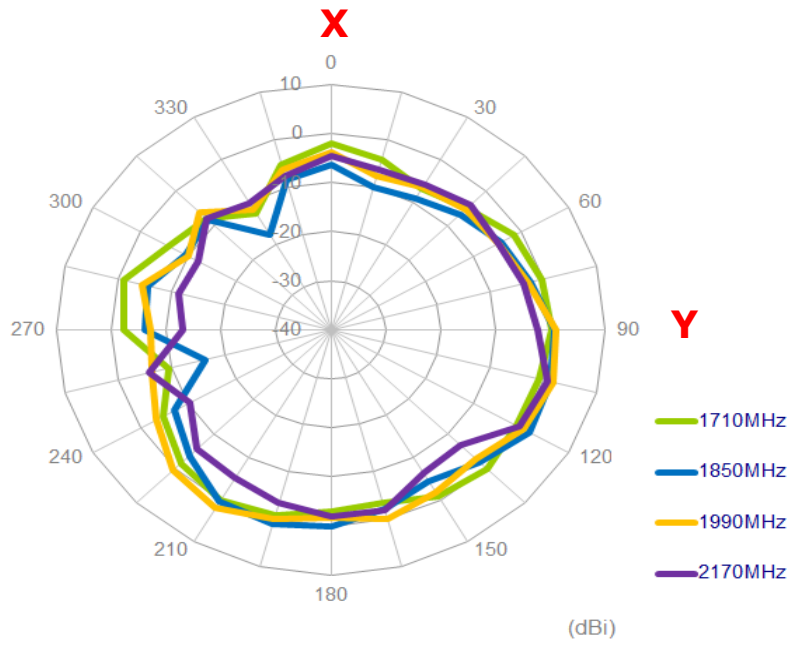
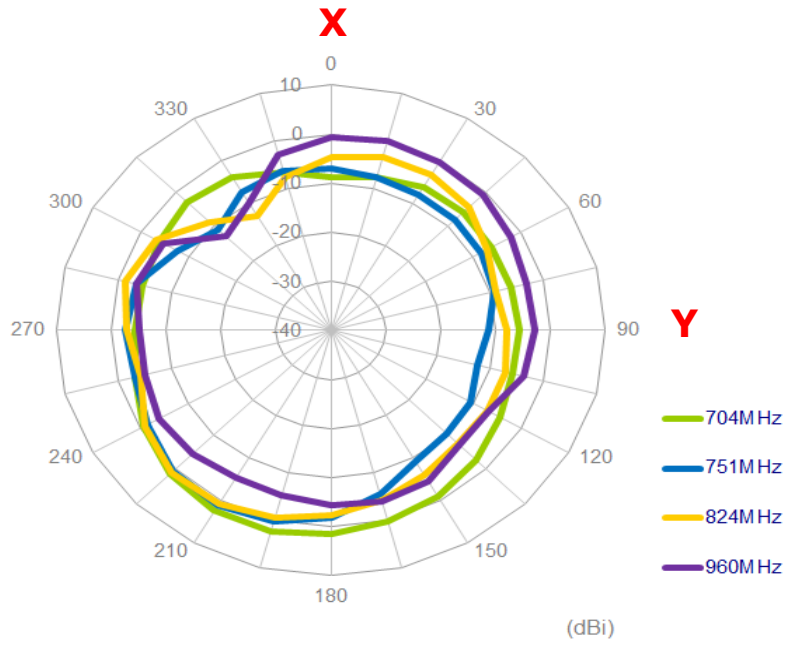

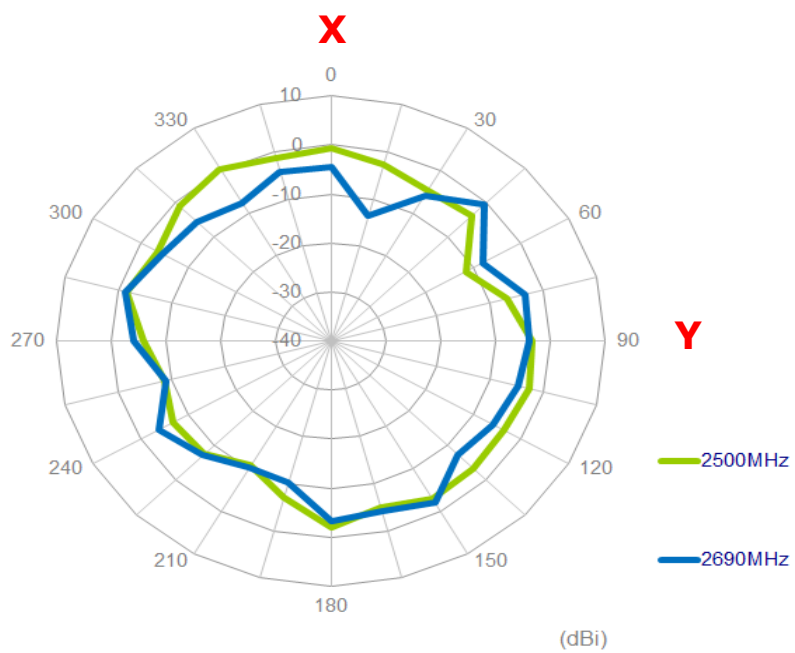

**XZ Plane**

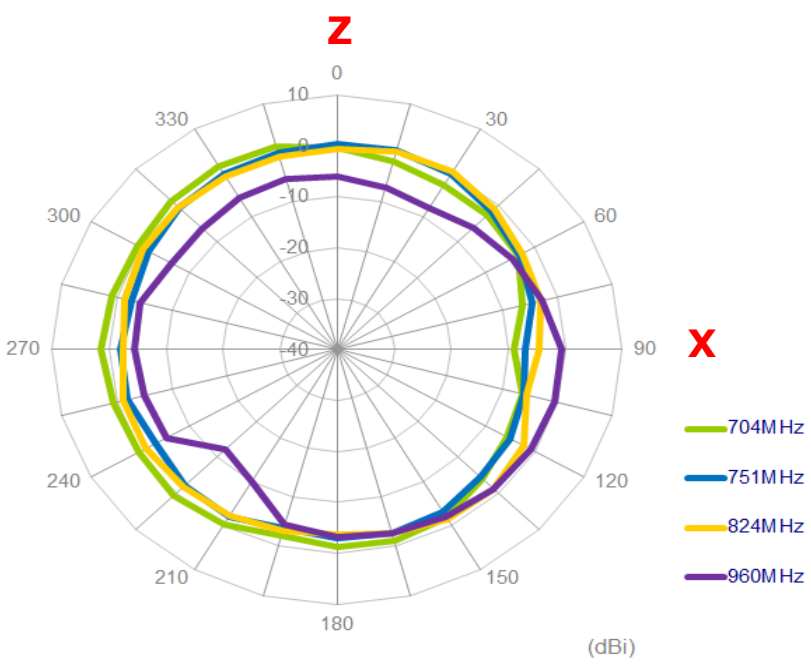

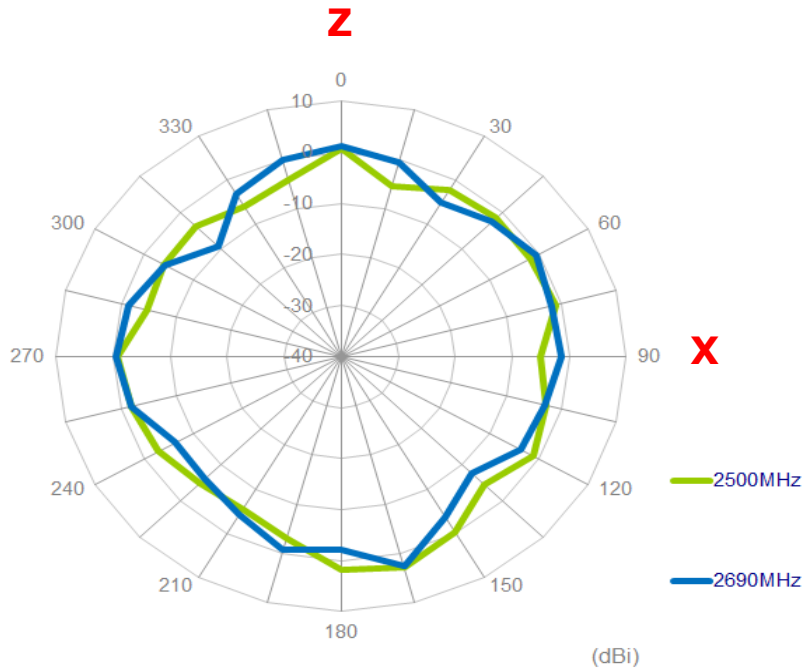
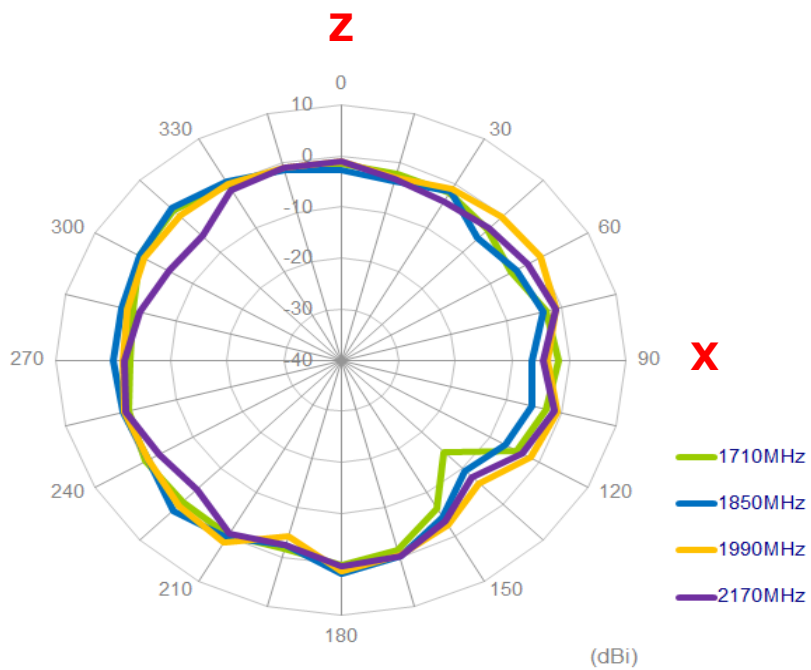

**YZ Plane**

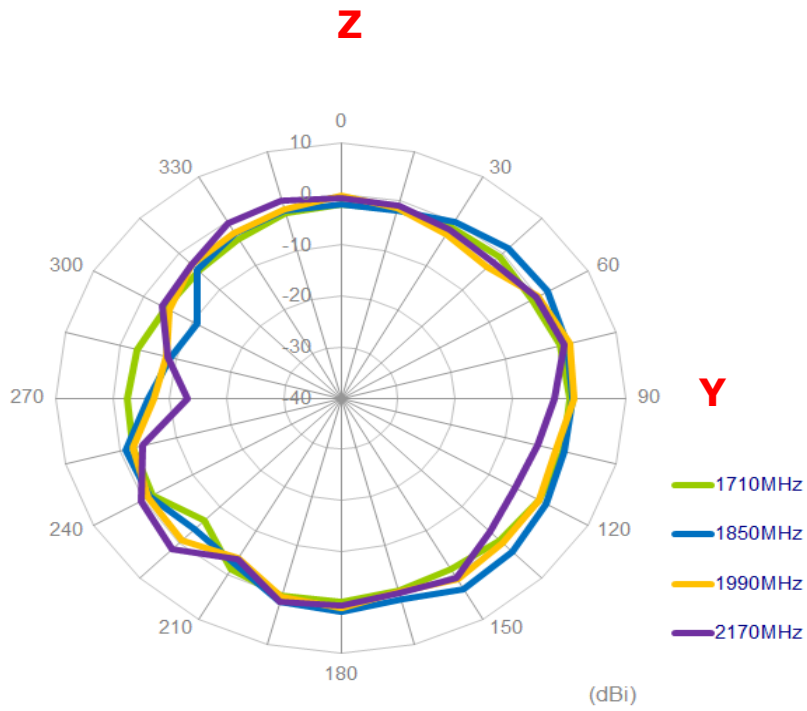
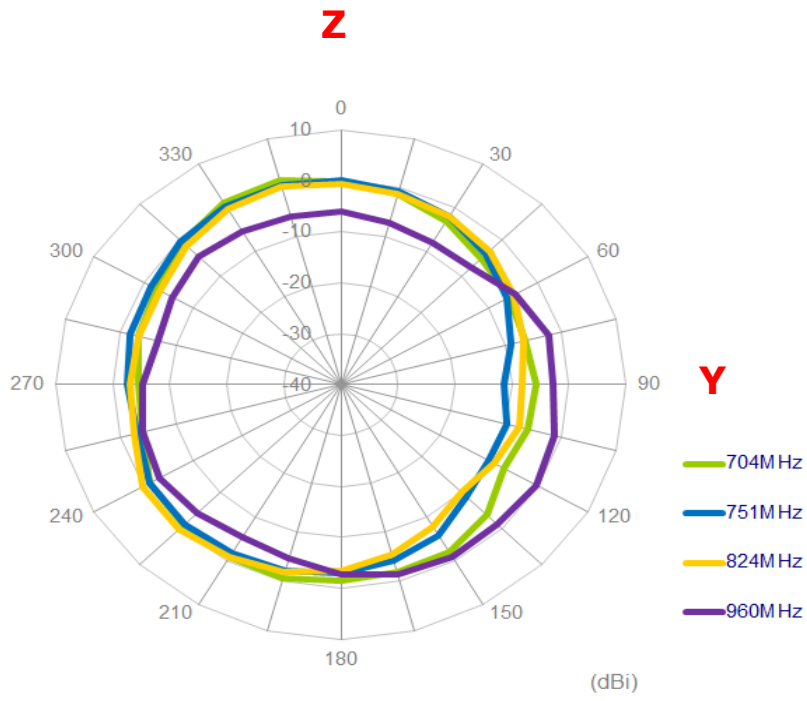

**Z**

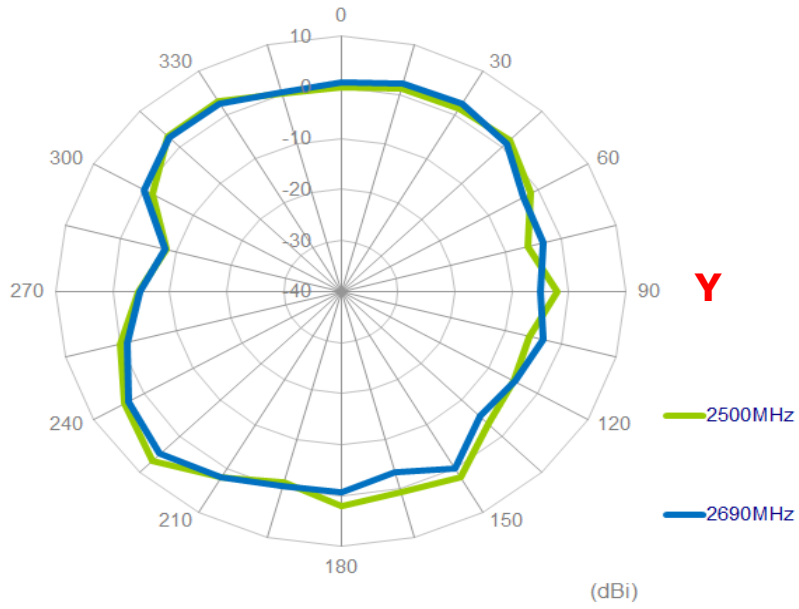

### 4.2.5 WIFI\_MIMO1

#### XY Plane

**X**

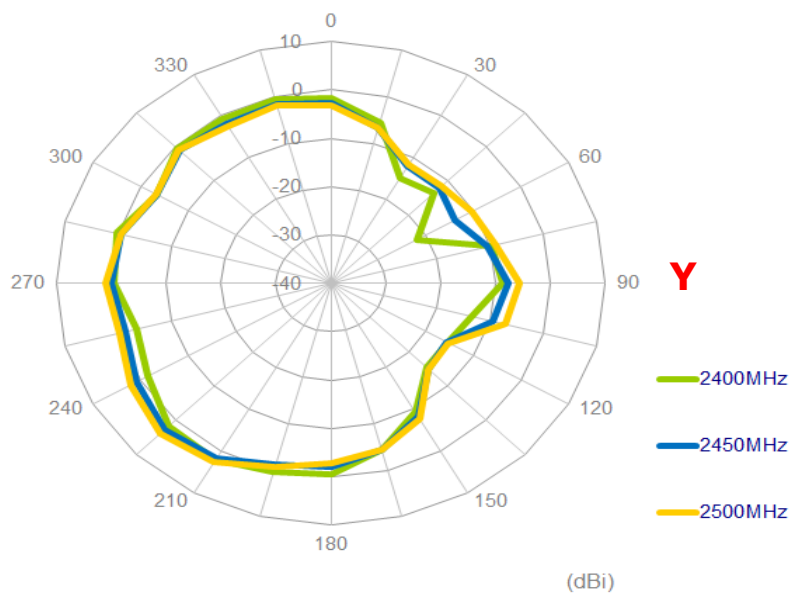

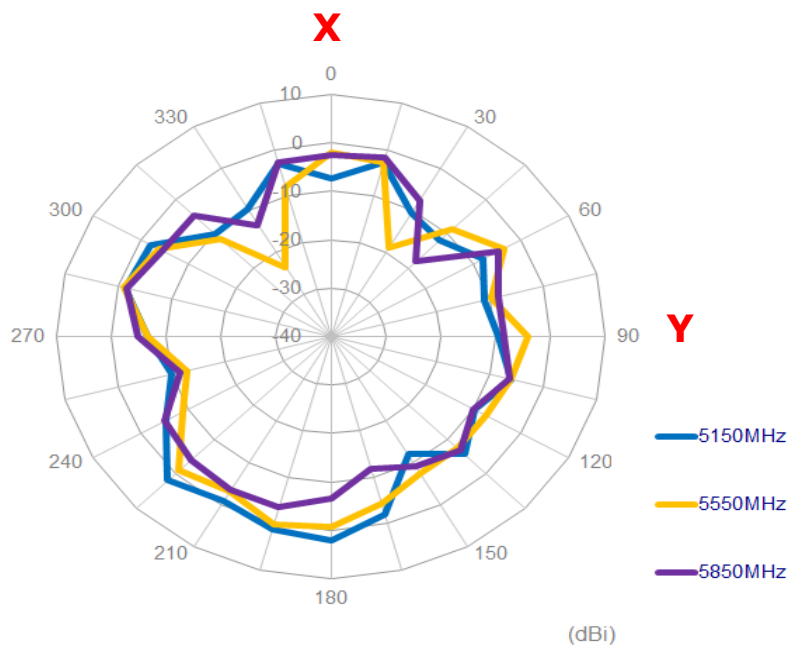

**XZ Plane**

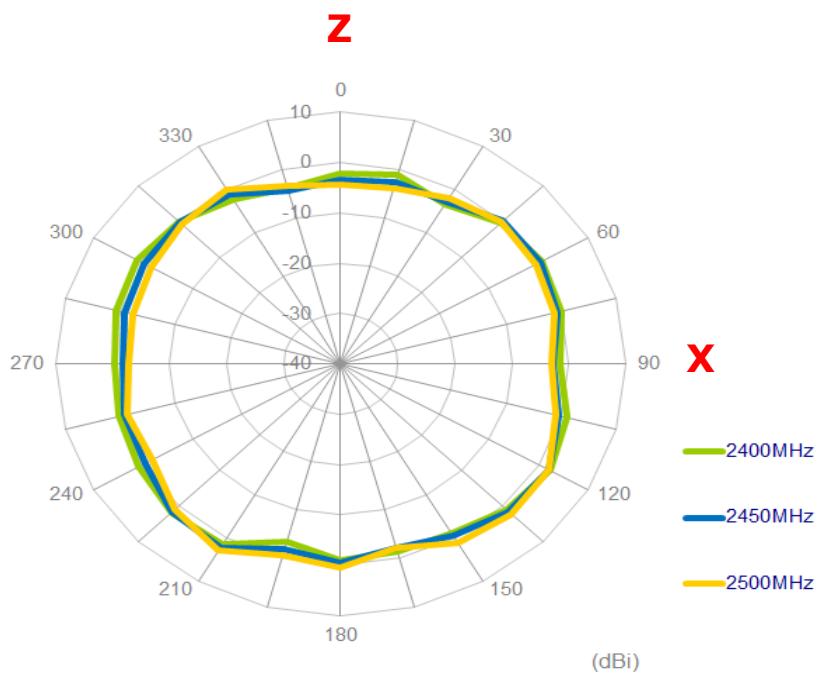



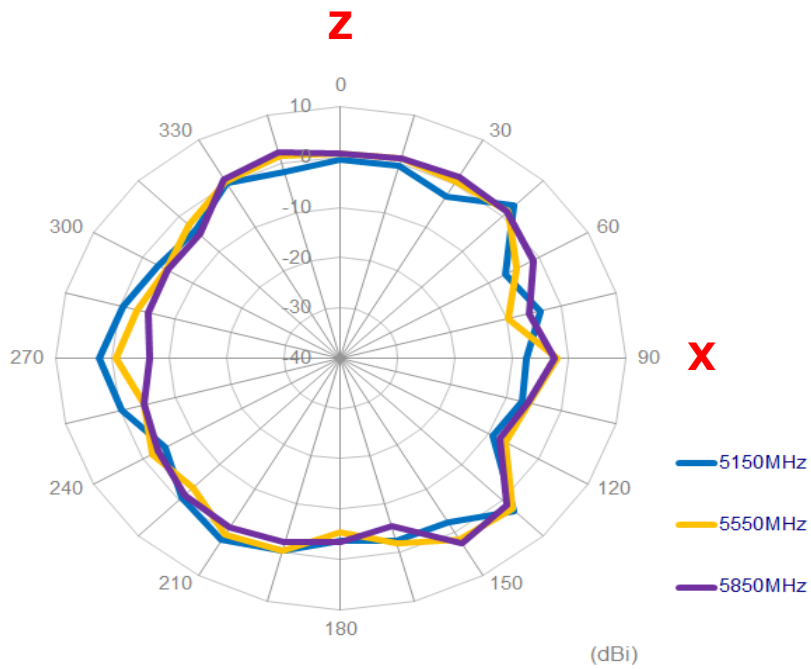

**YZ Plane**

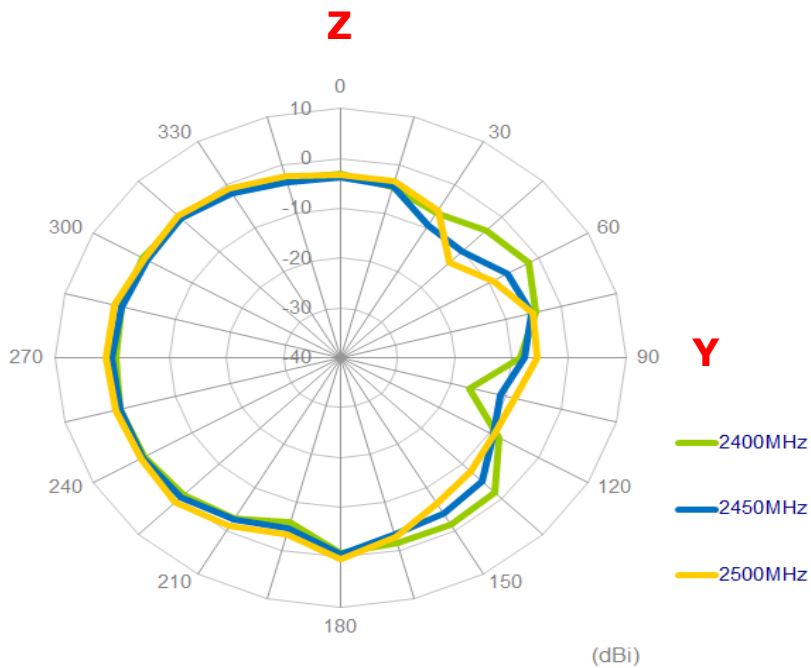

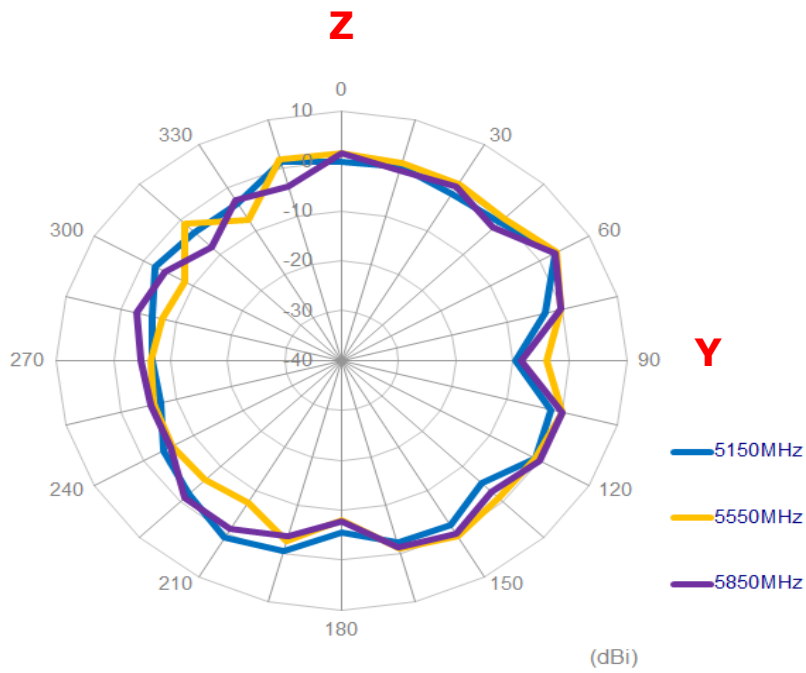

### 4.2.6 WIFI\_MIMO2

#### XY Plane

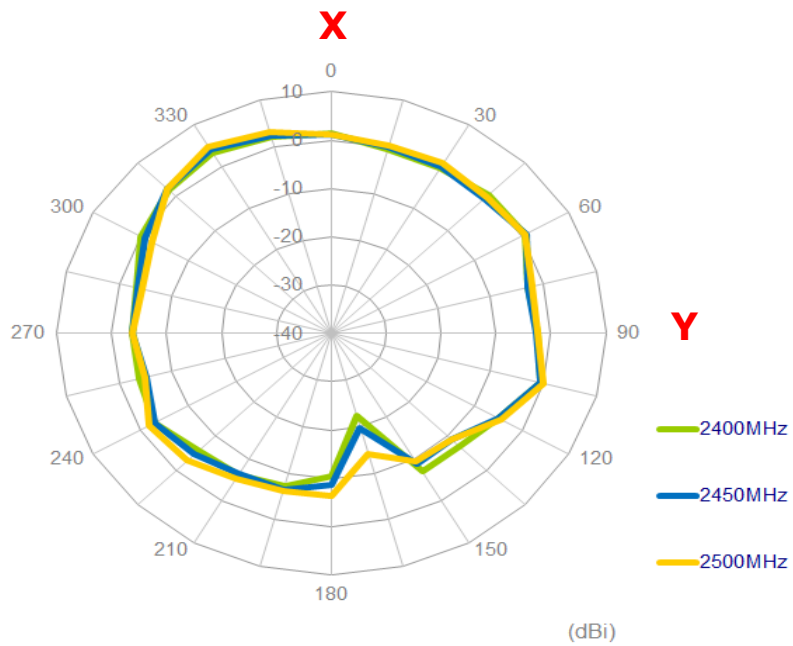

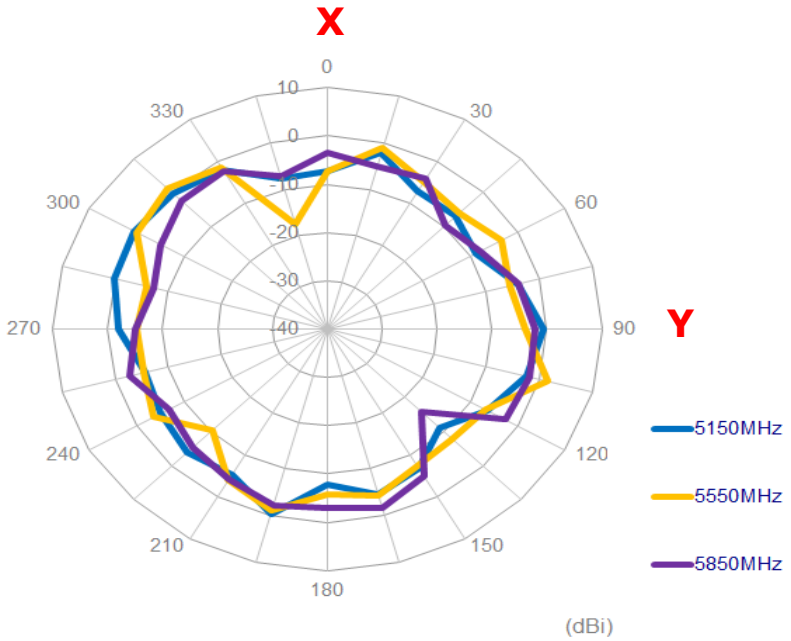

**XZ Plane**

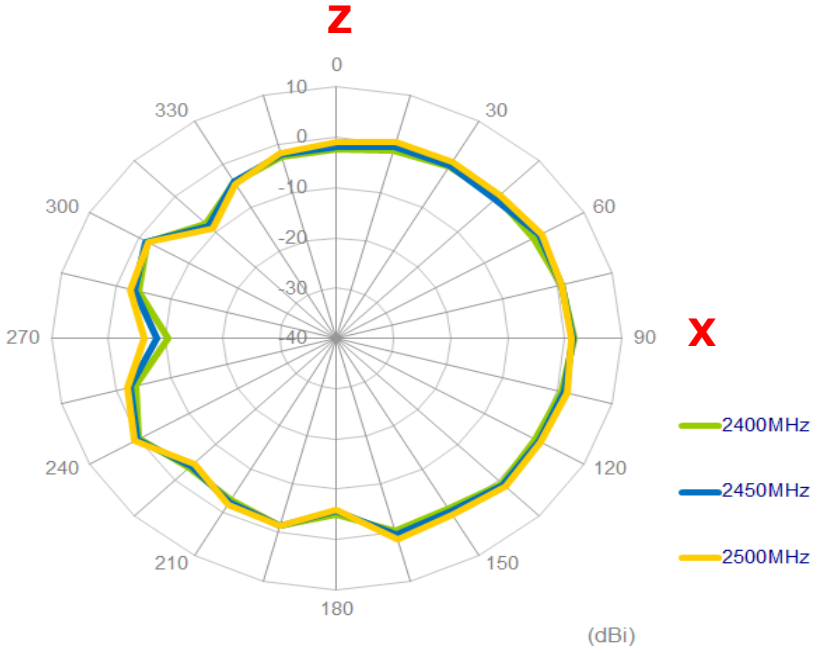

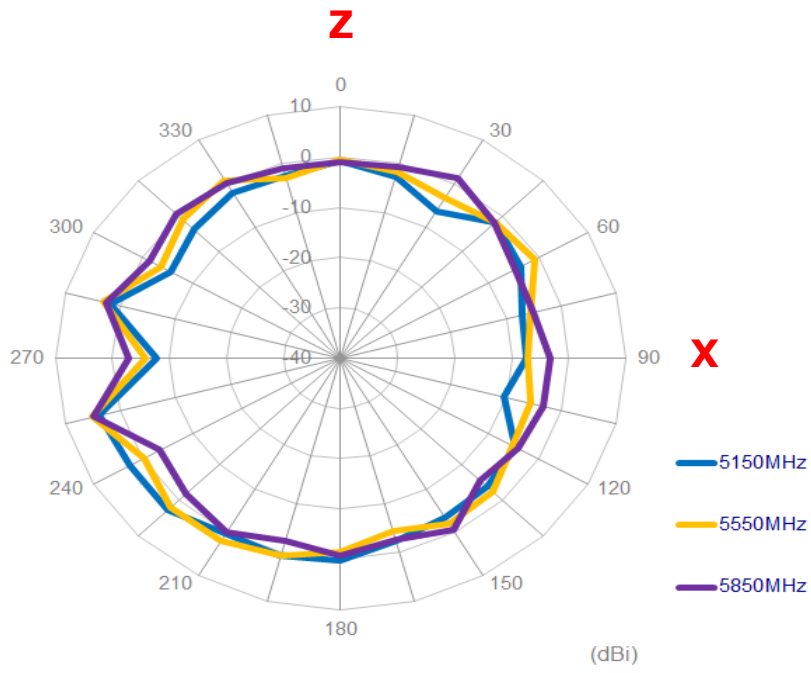

**YZ Plane**

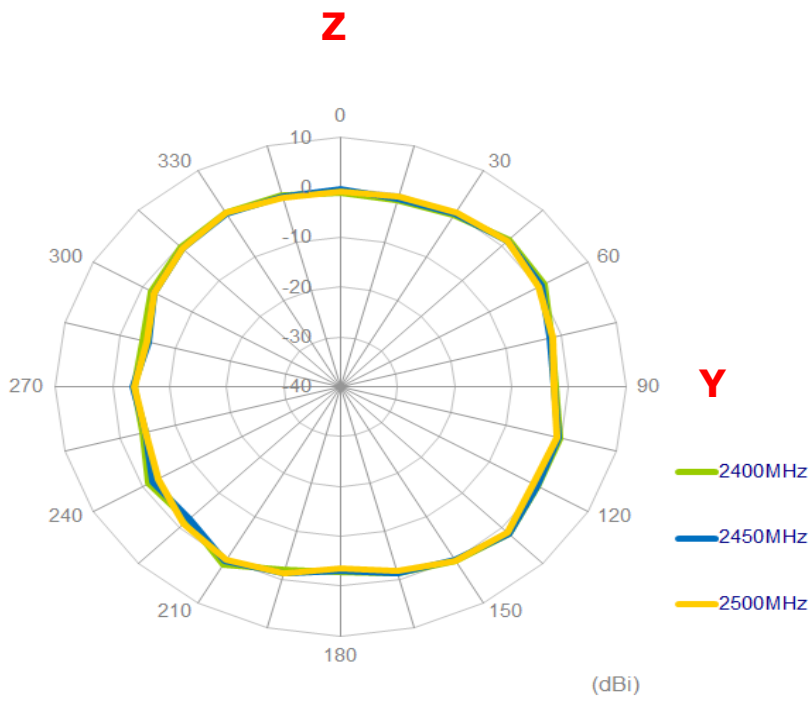

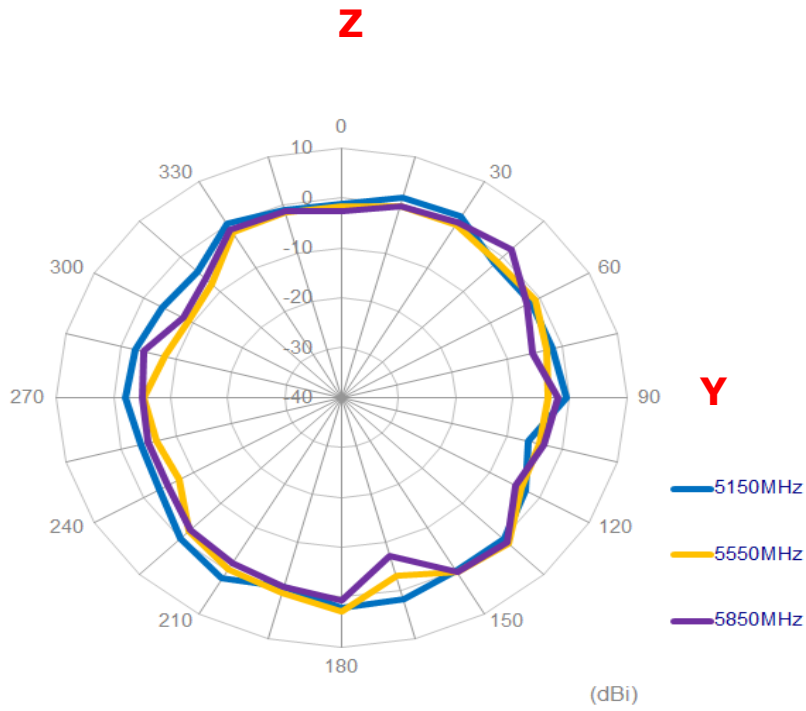

### 4.2.7 WIFI\_MIMO3

#### XY Plane

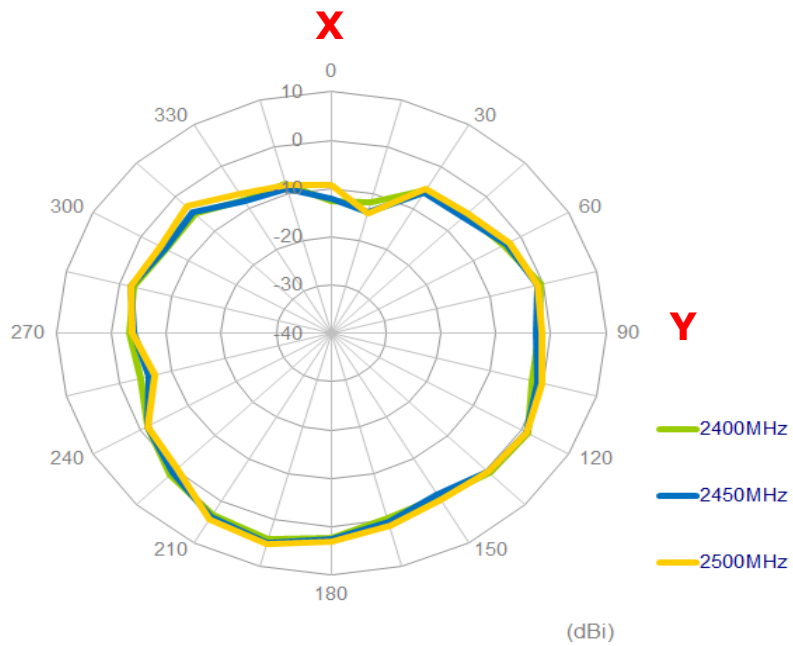

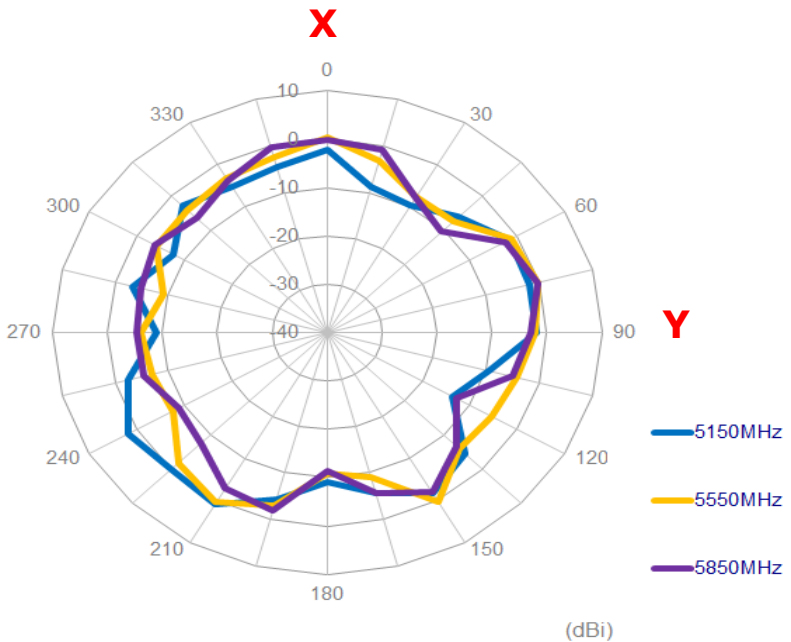

**XZ Plane**

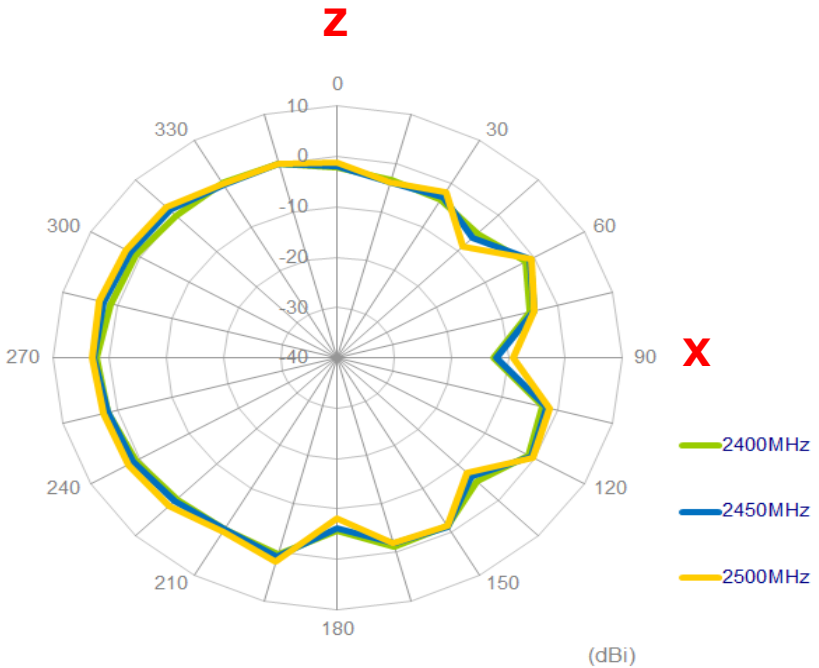

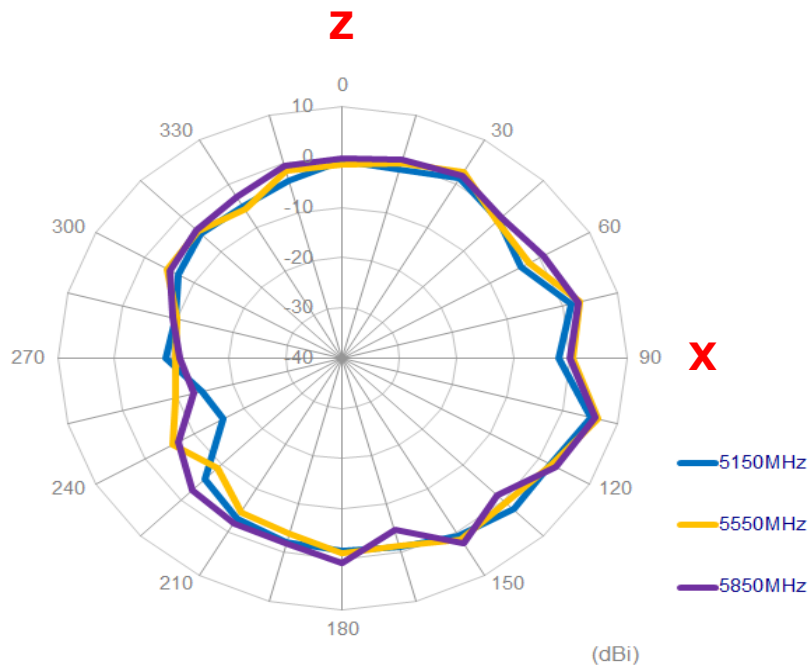

**YZ Plane**

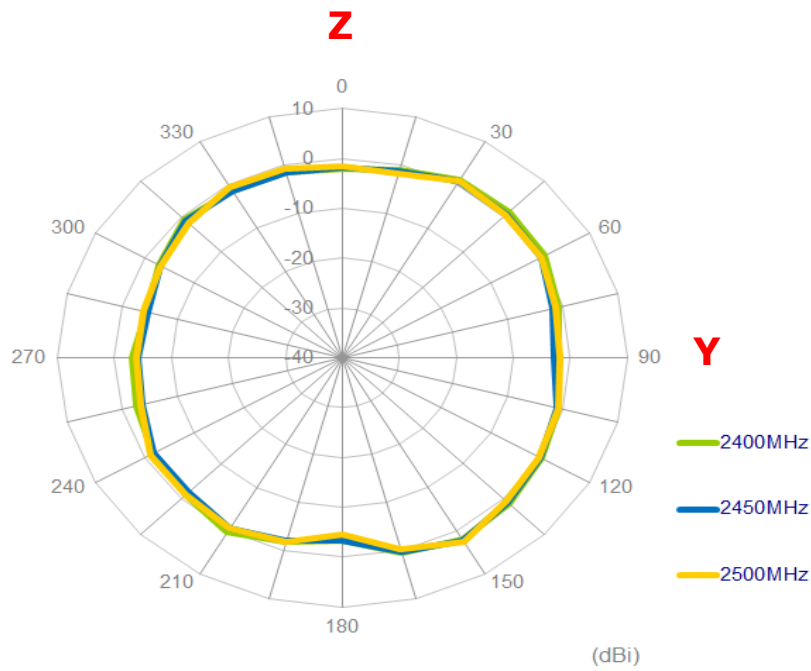

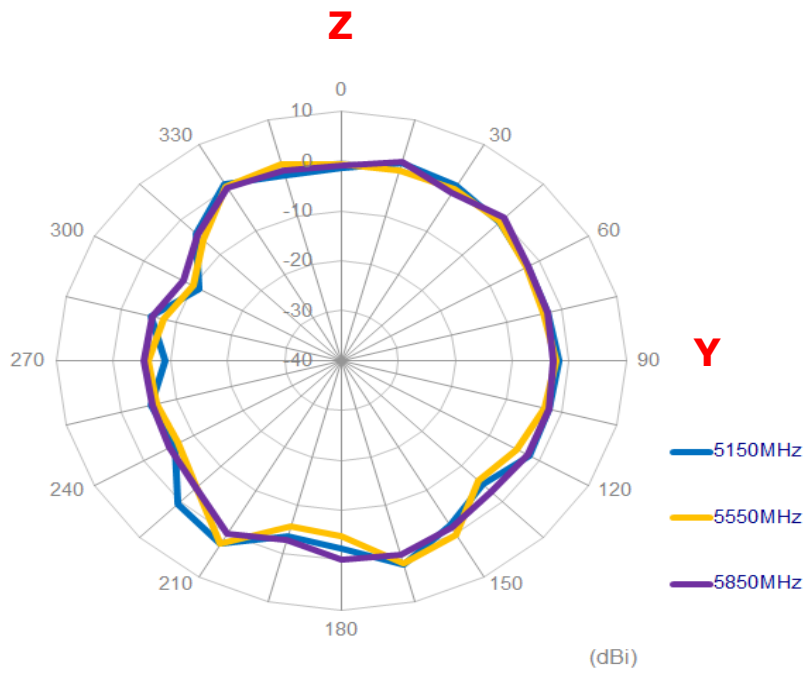



## 4.3 3D Radiation Patterns

### 4.3.1 LTE\_MIMO1

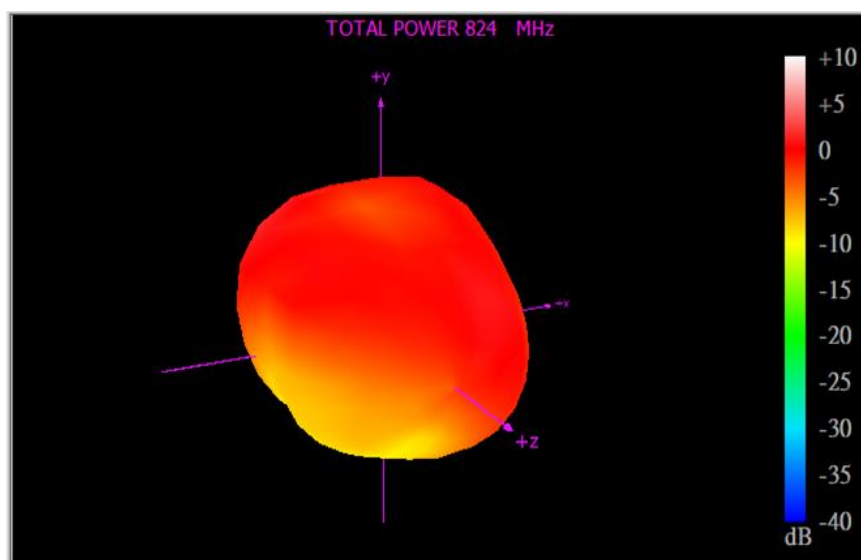
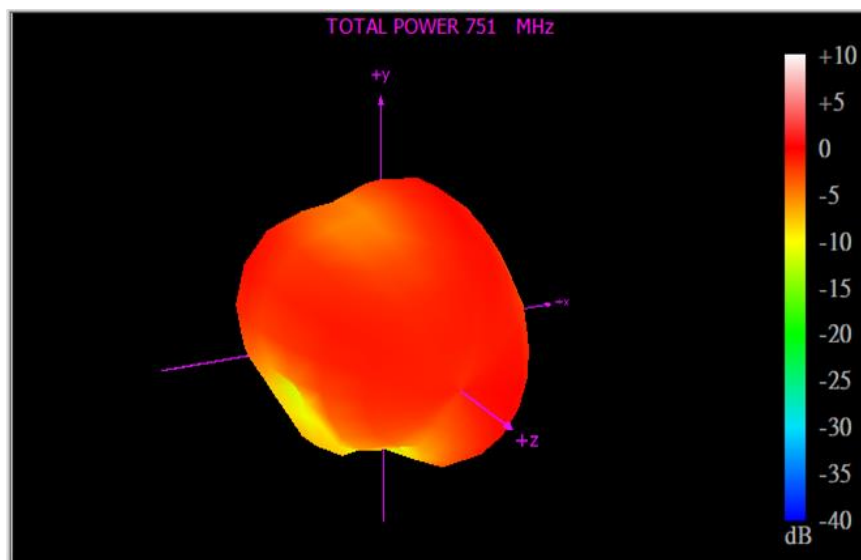
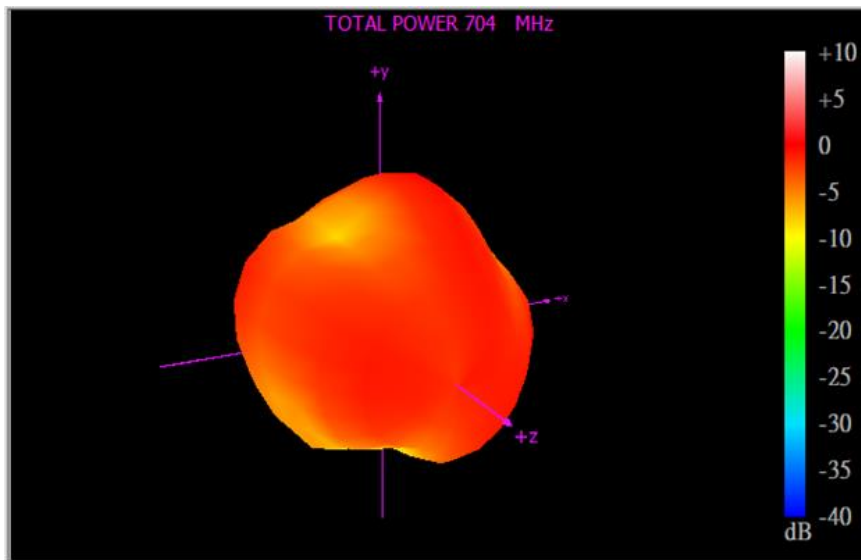

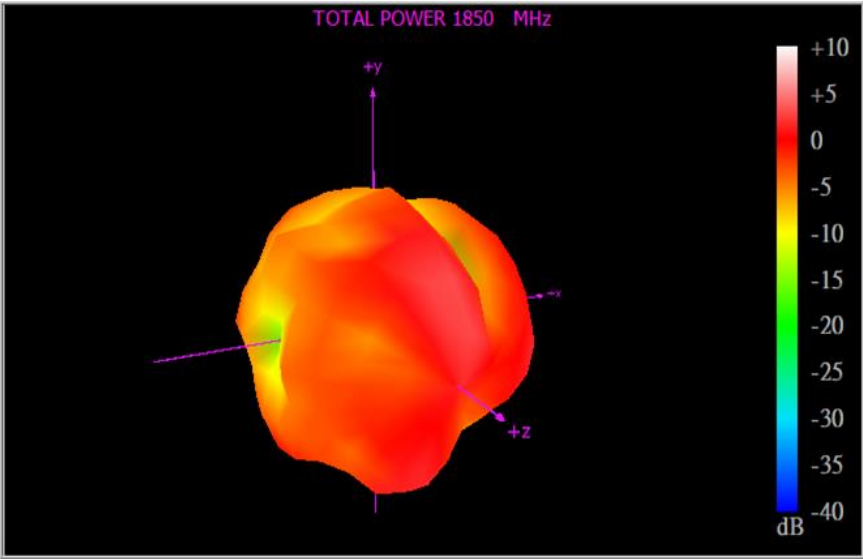
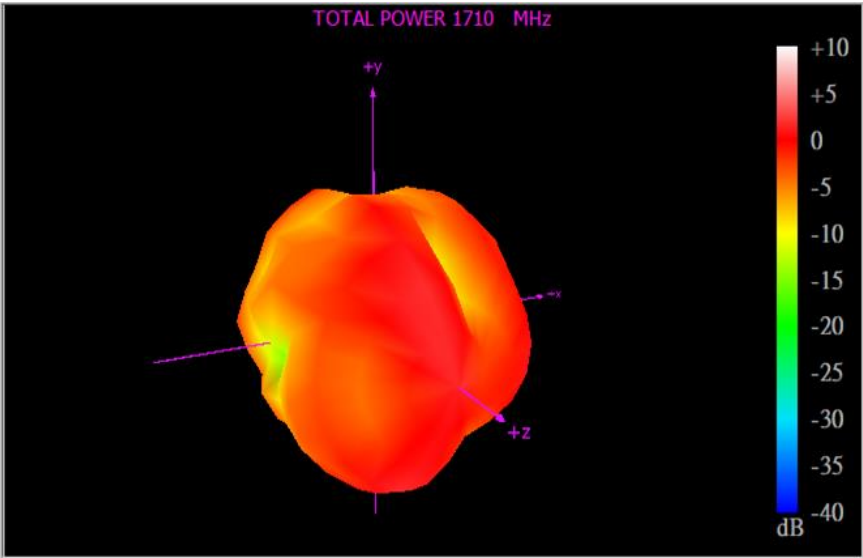
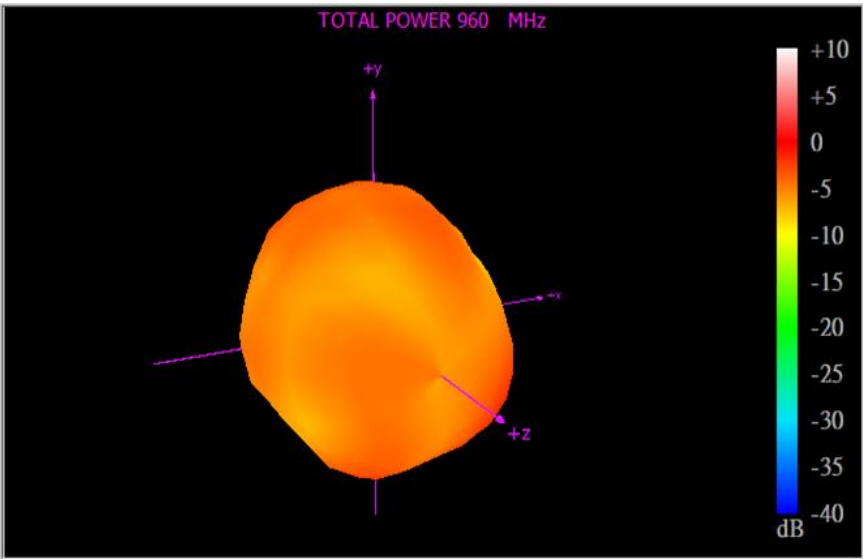

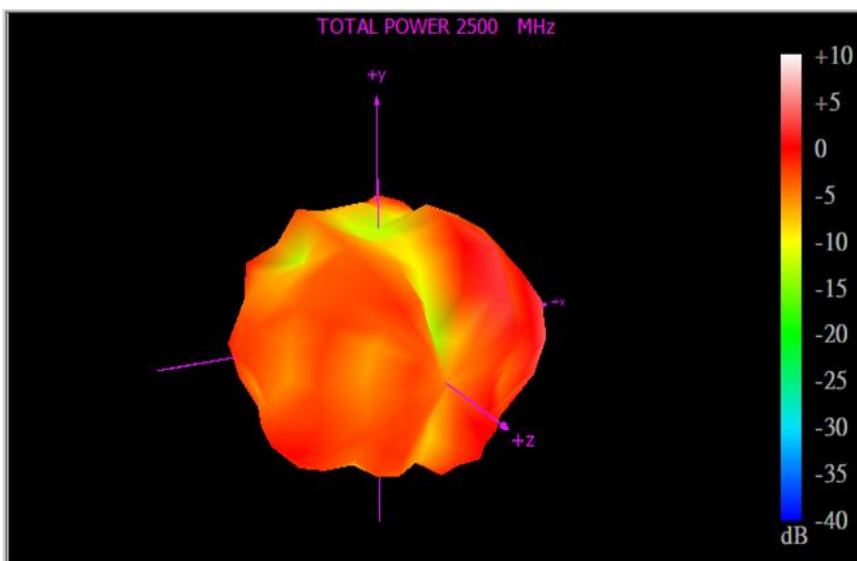
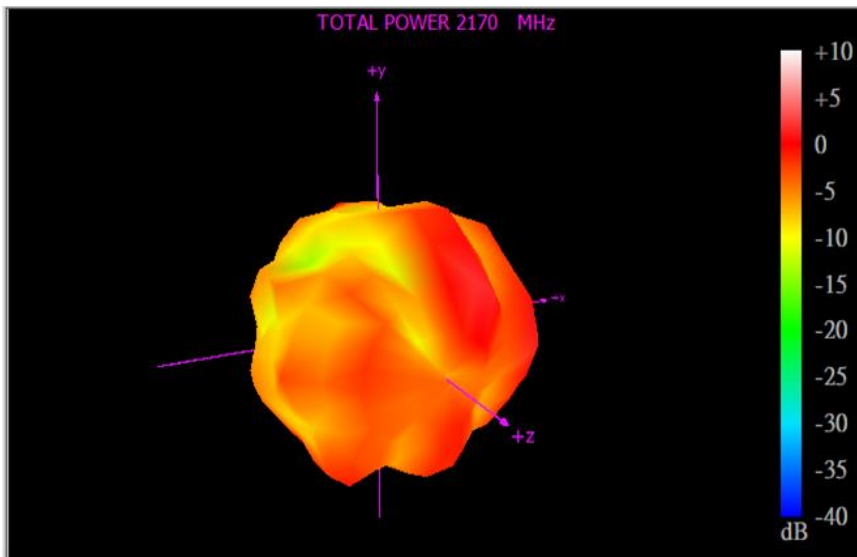
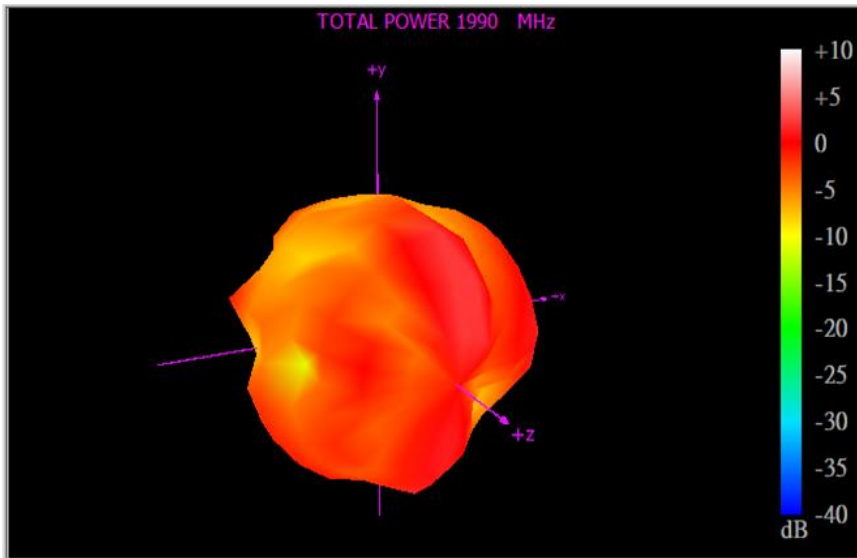

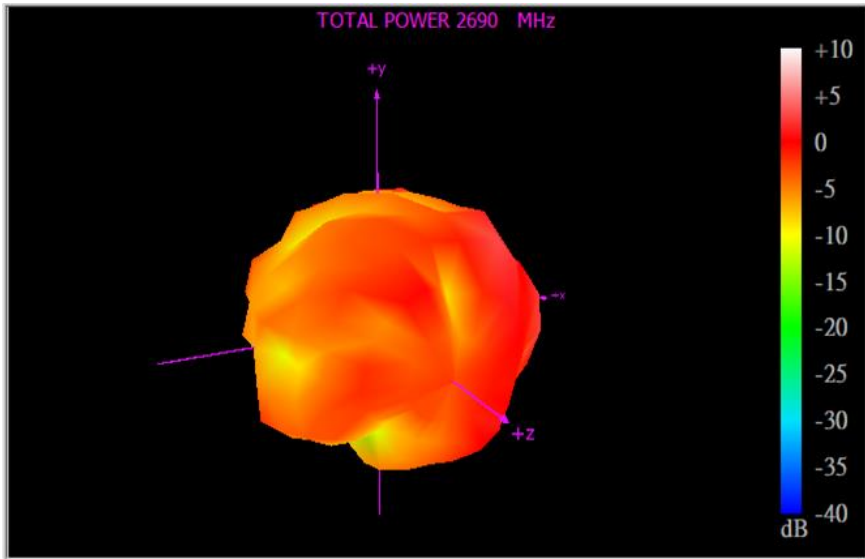

### 4.3.2 LTE\_MIMO2

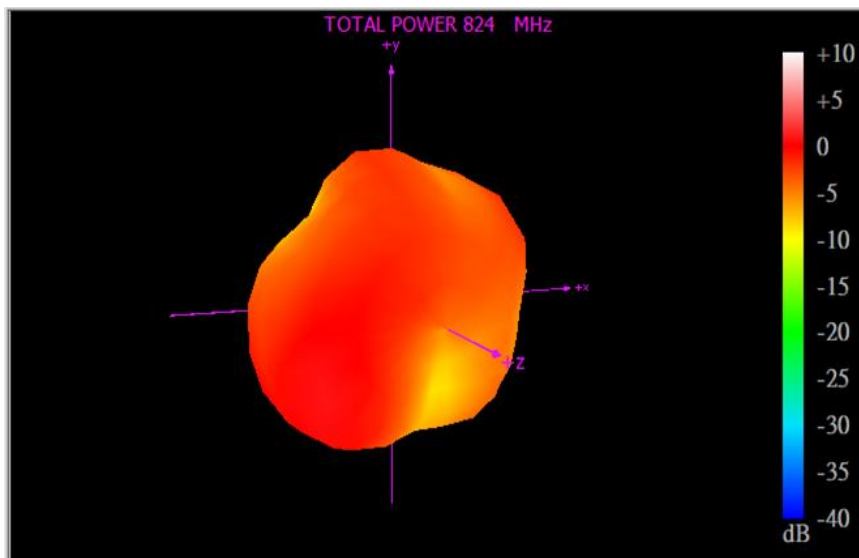
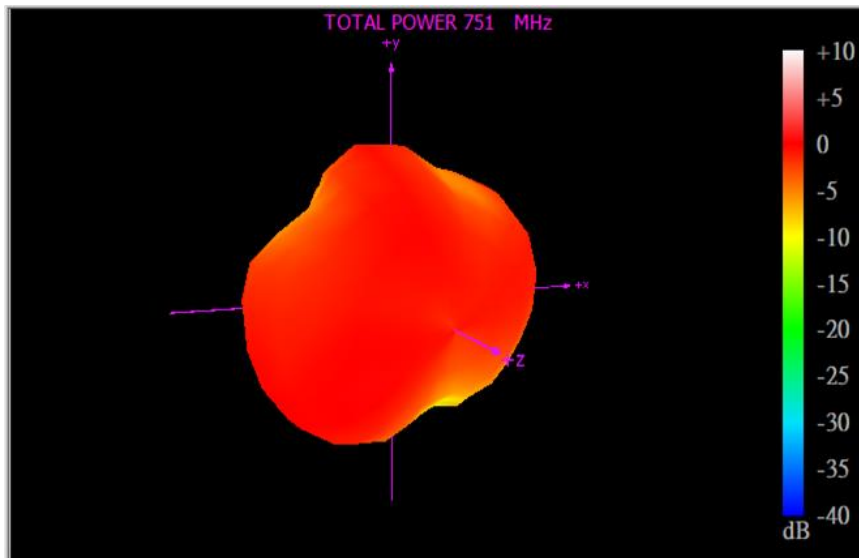
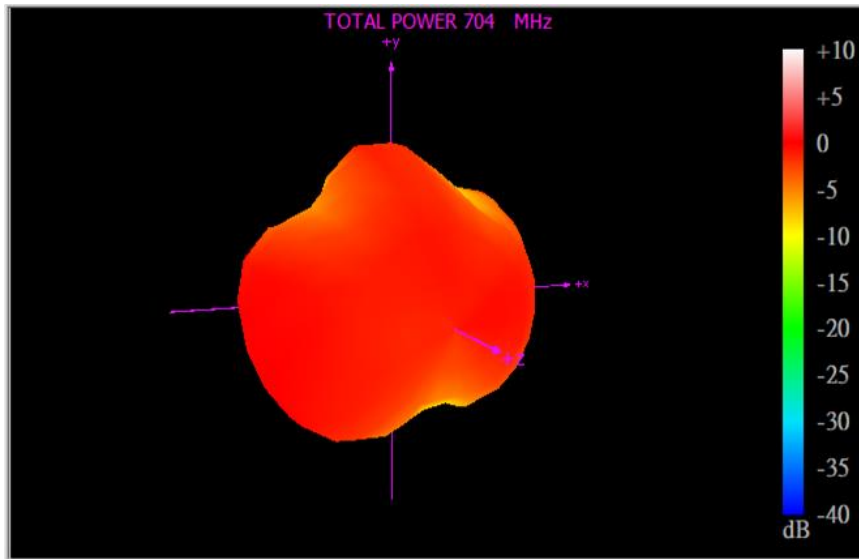

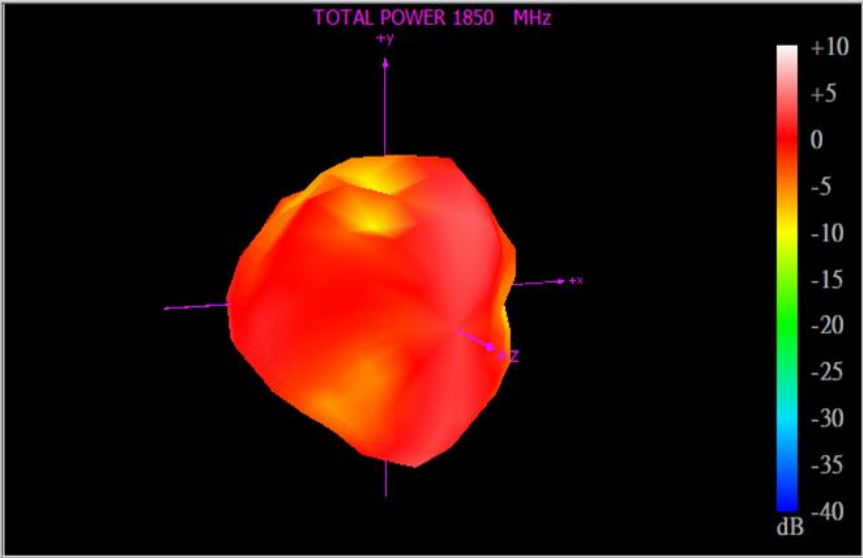
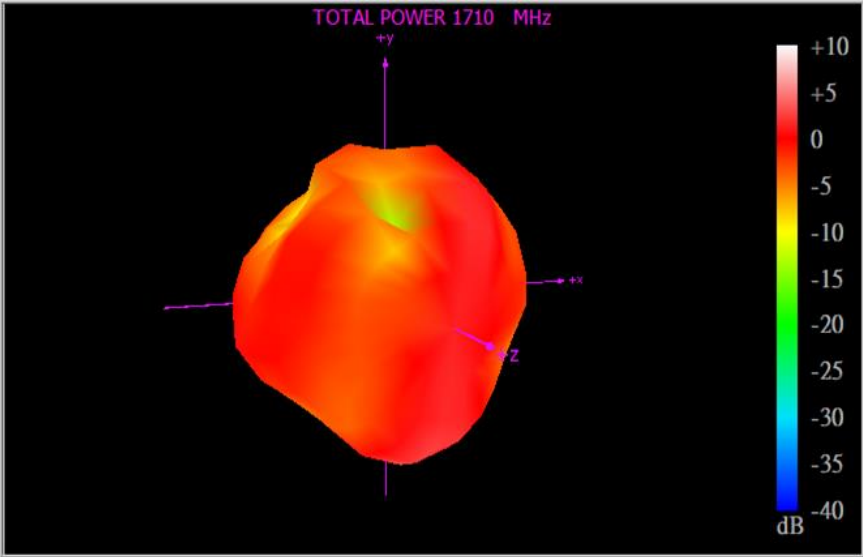
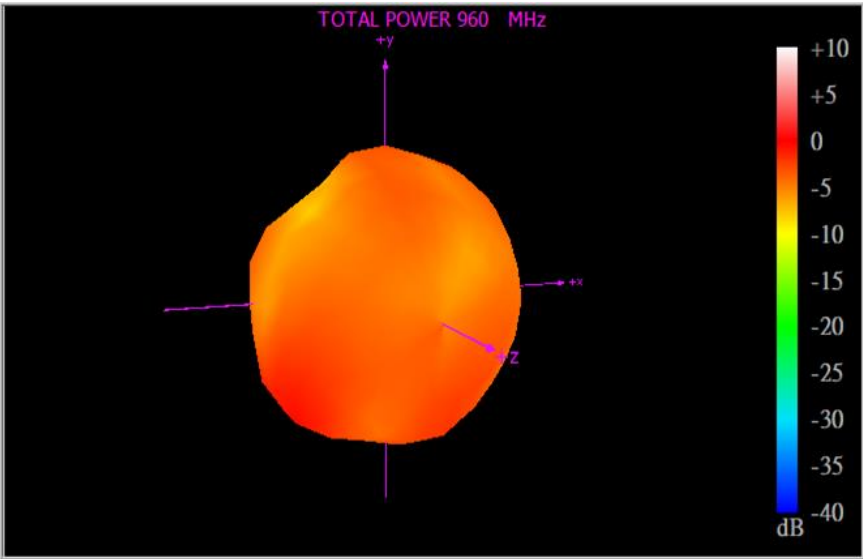

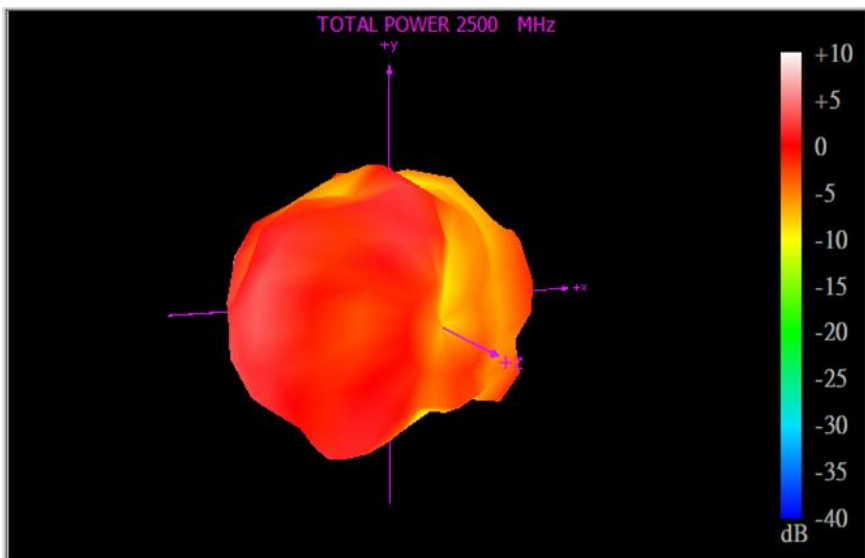
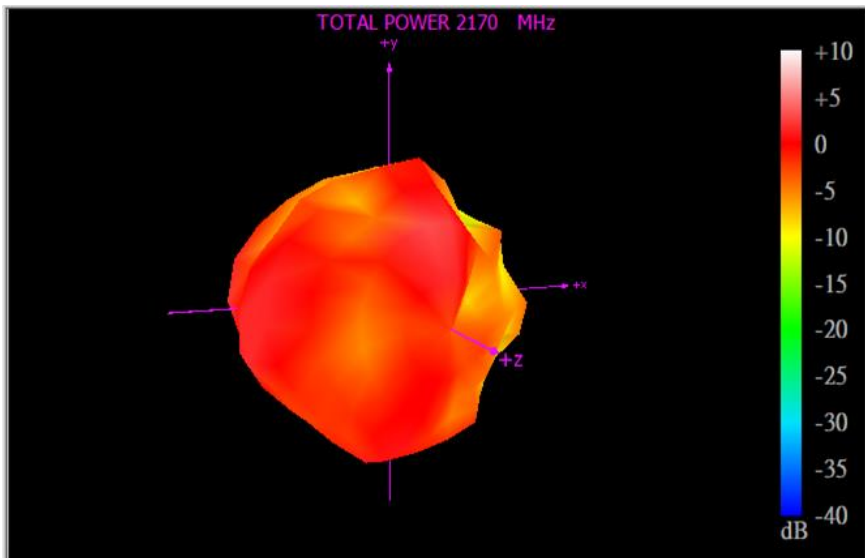
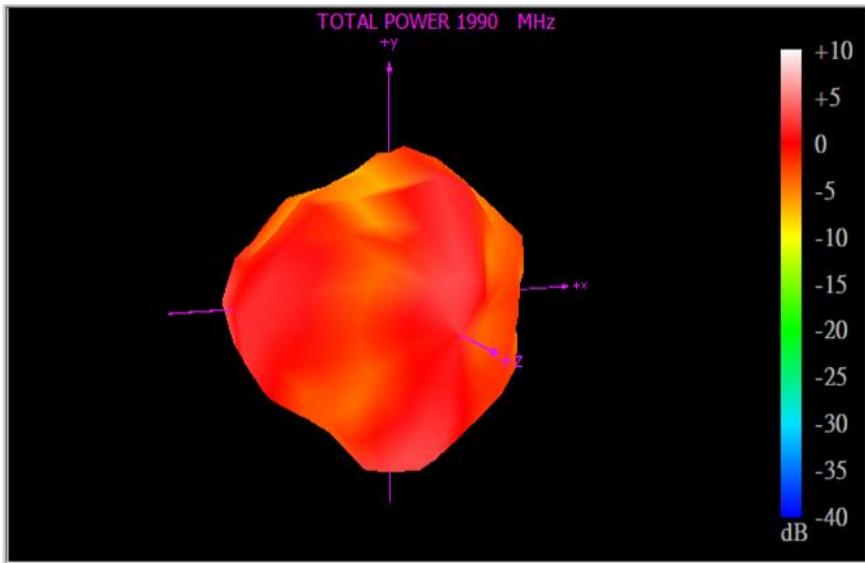

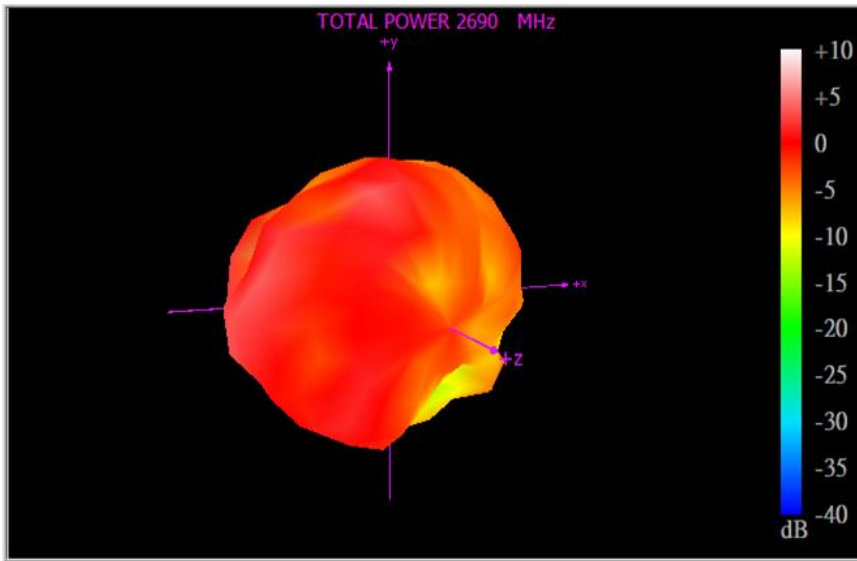



### 4.3.3 LTE\_MIMO3

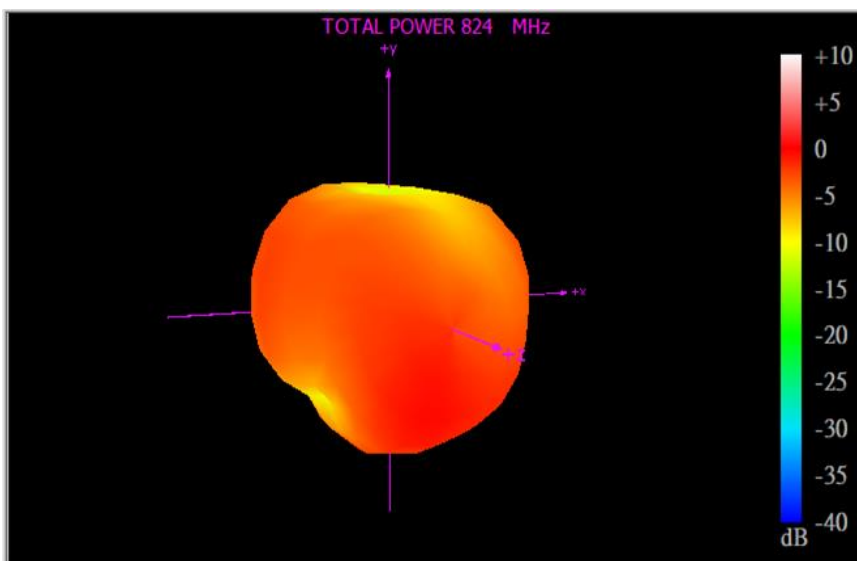
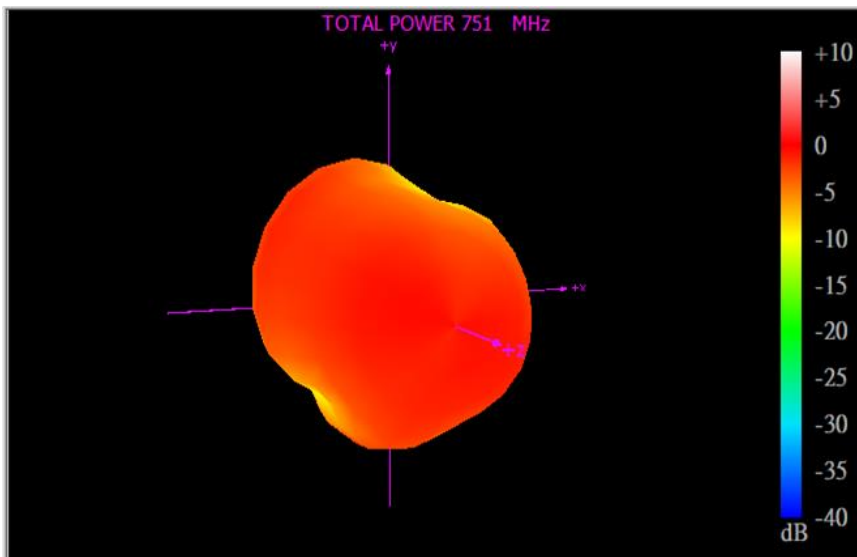
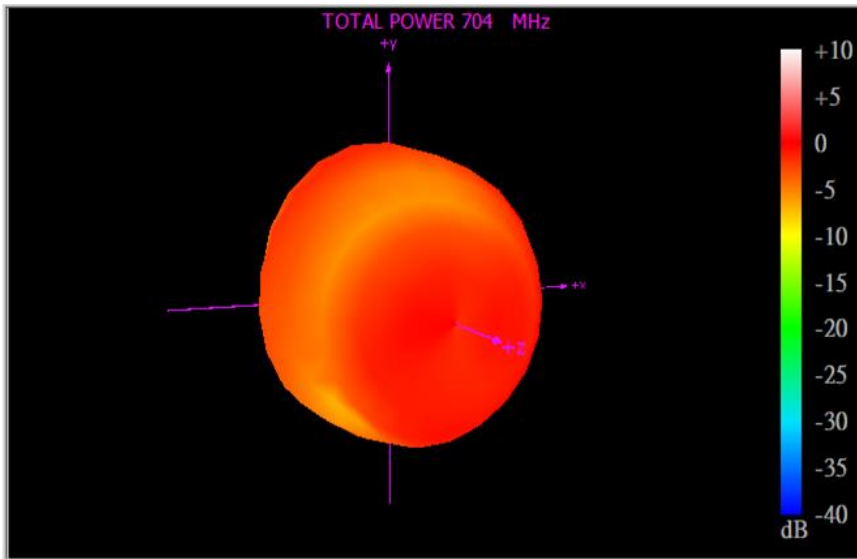

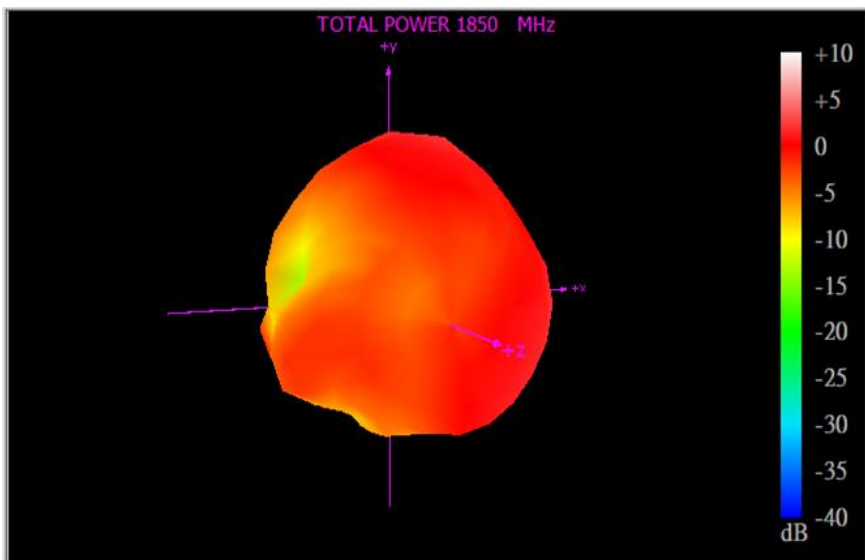
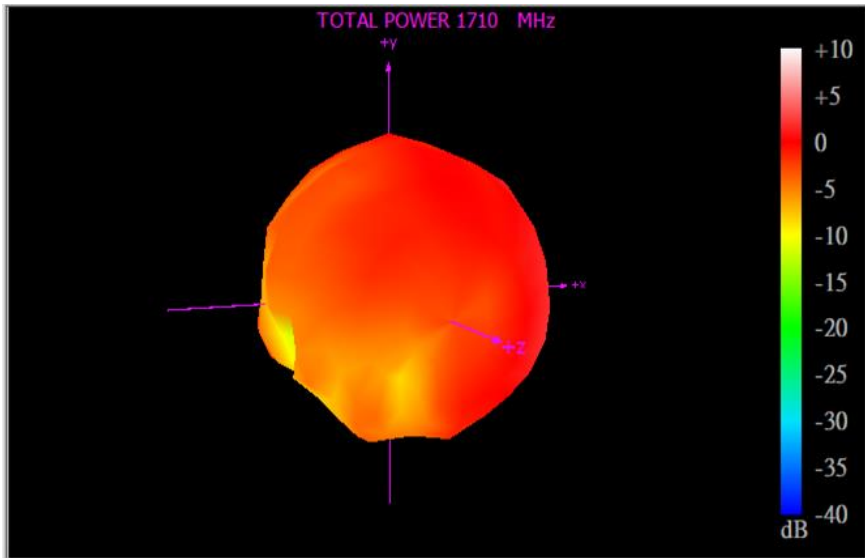
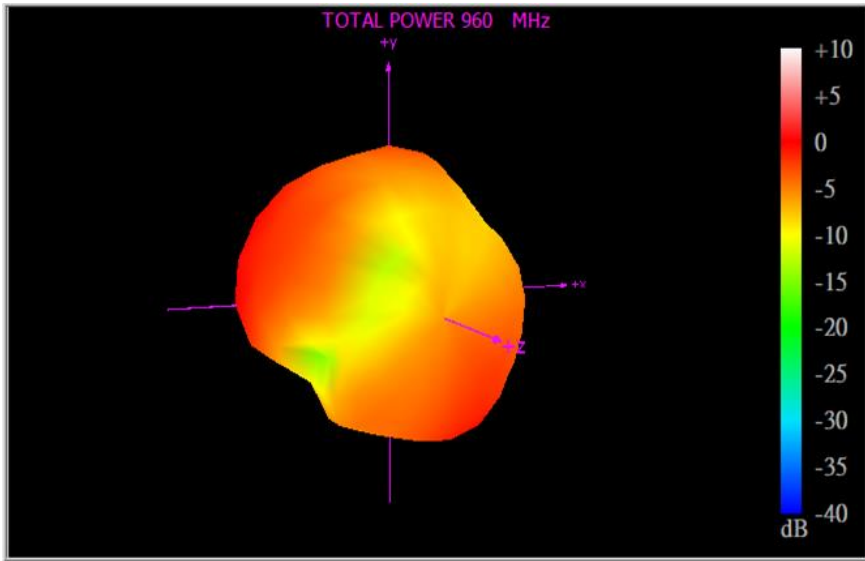

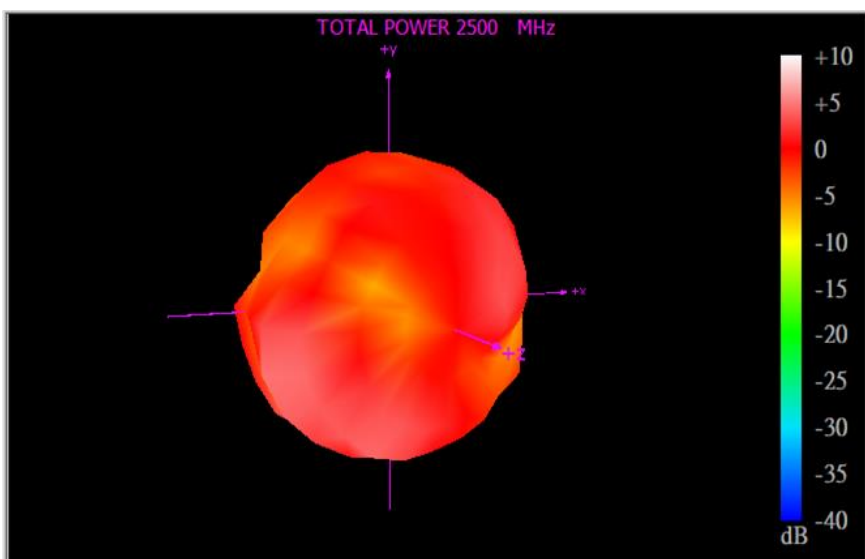
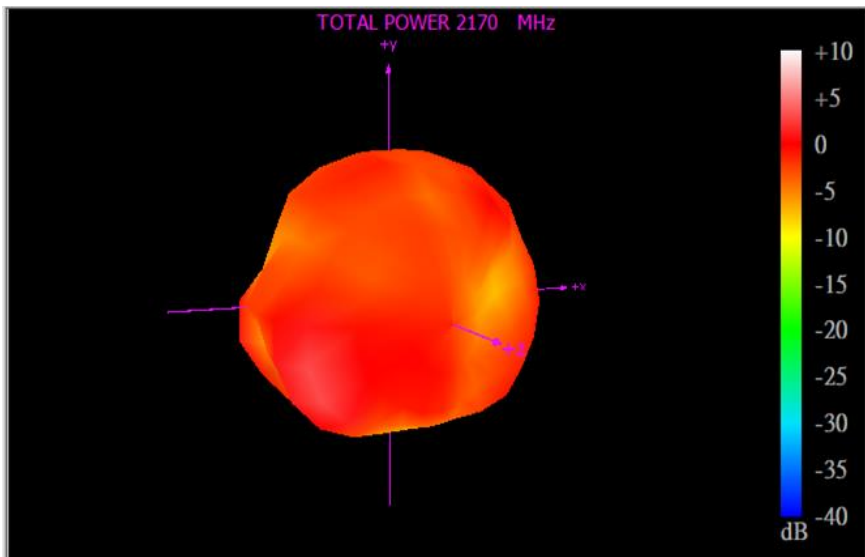
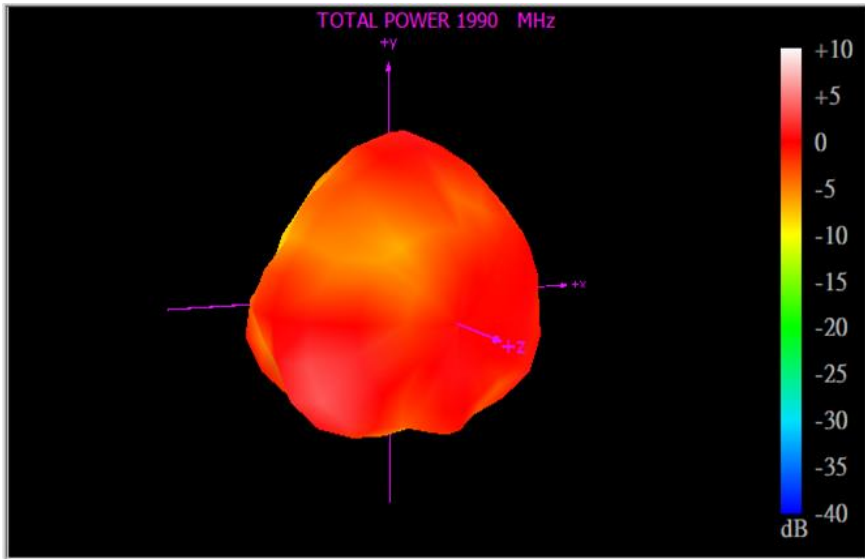

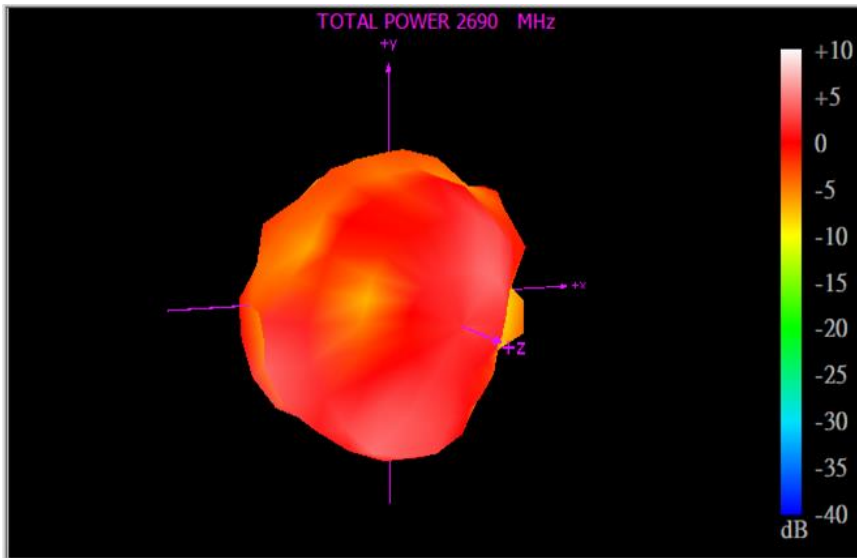

### 4.3.4 LTE\_MIMO4

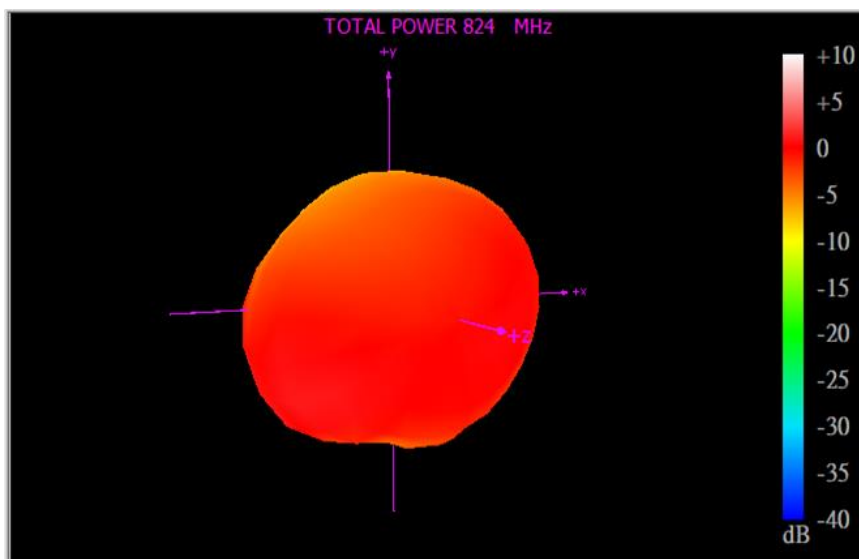
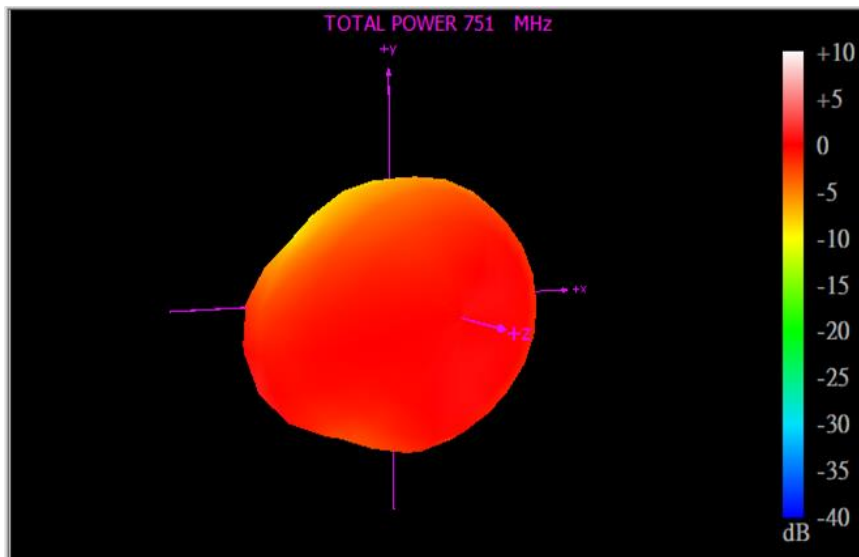
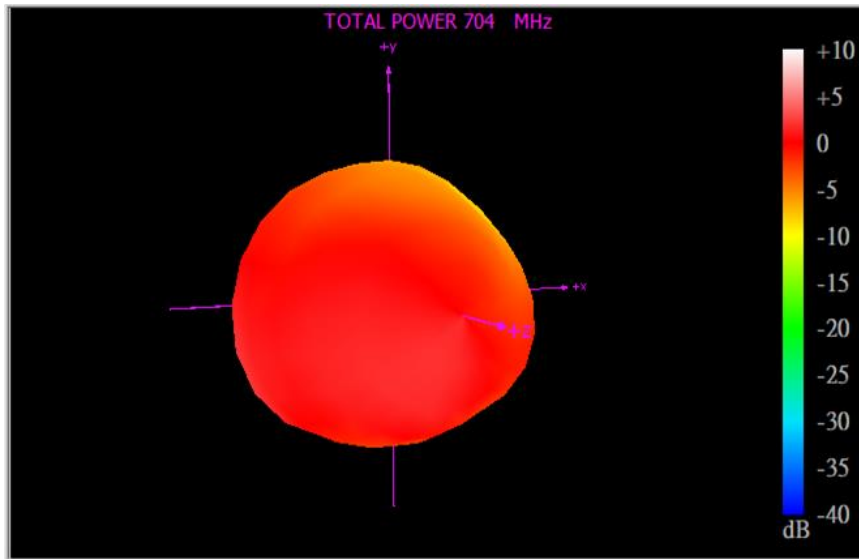

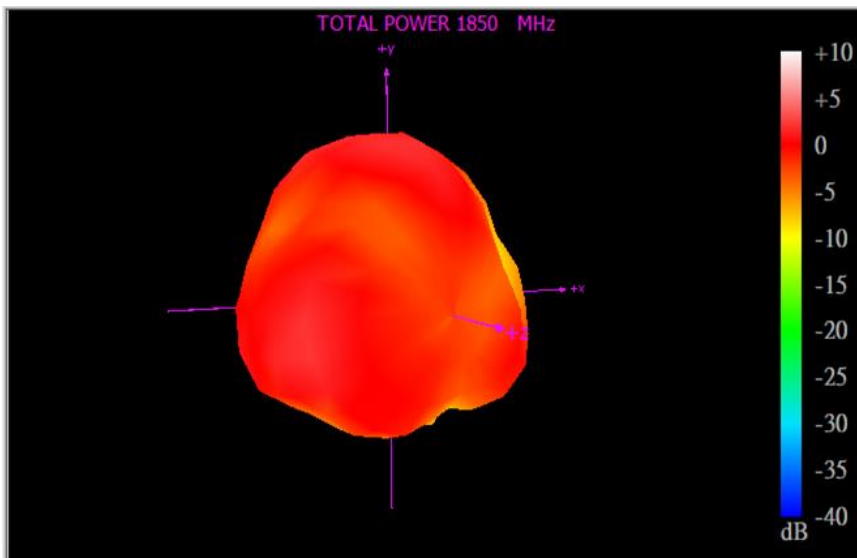
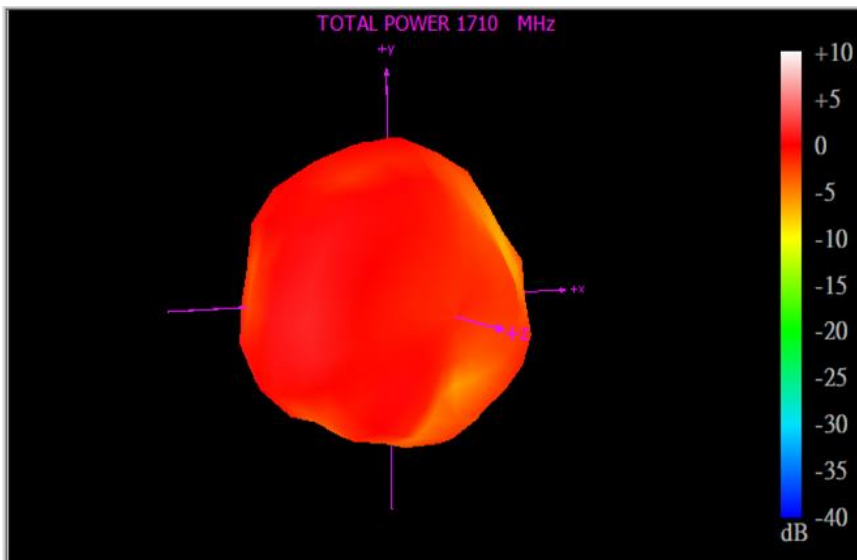
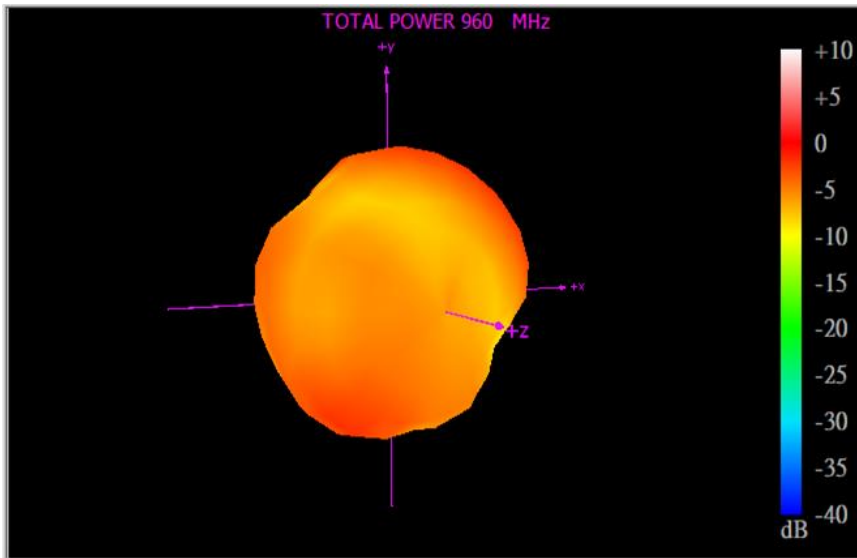

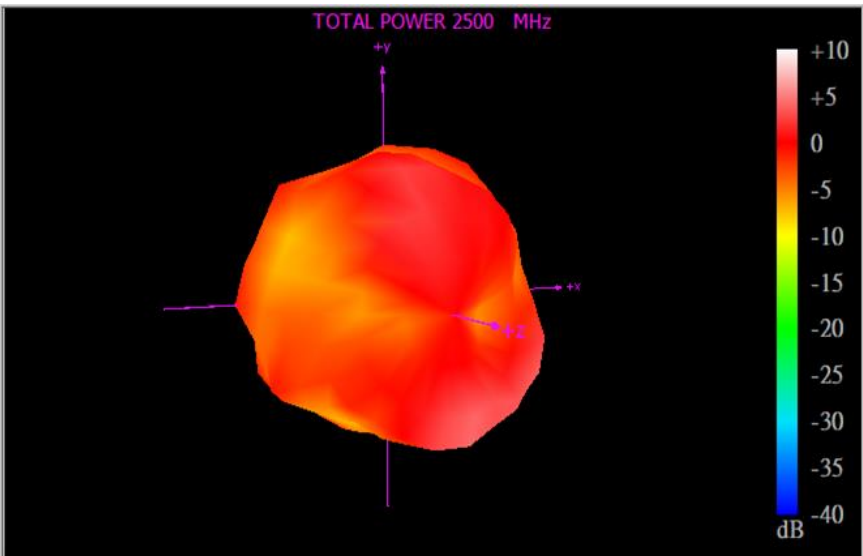
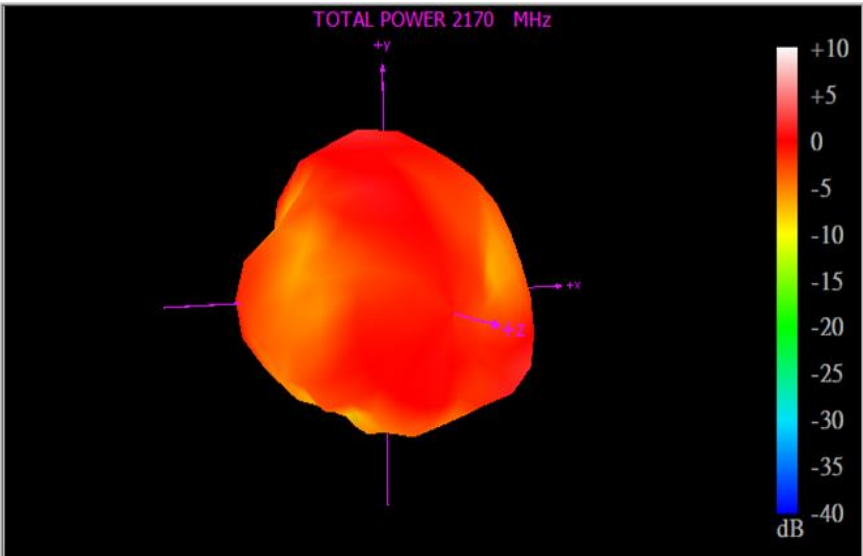
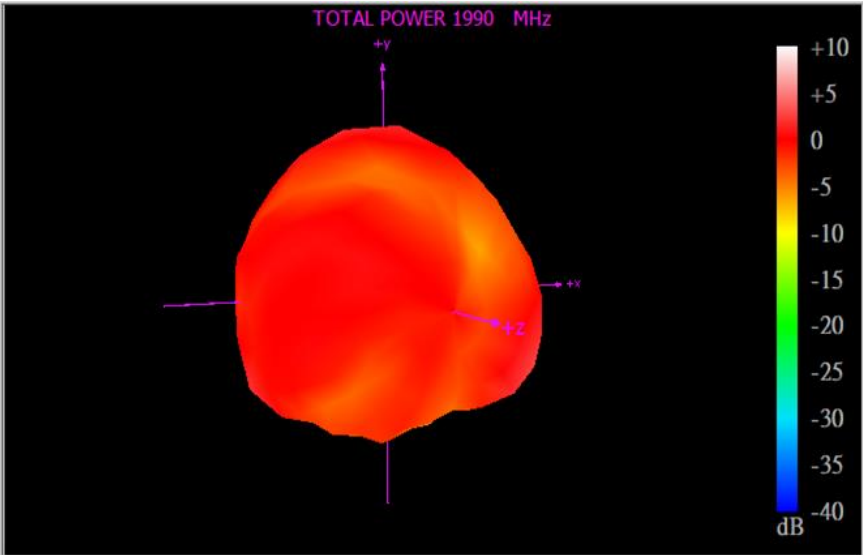

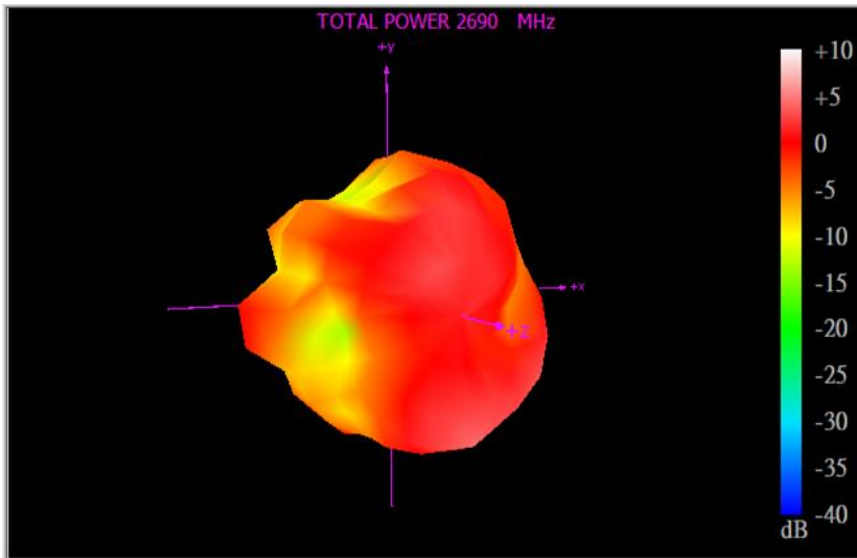



### 4.3.5 WIFI\_MIMO1

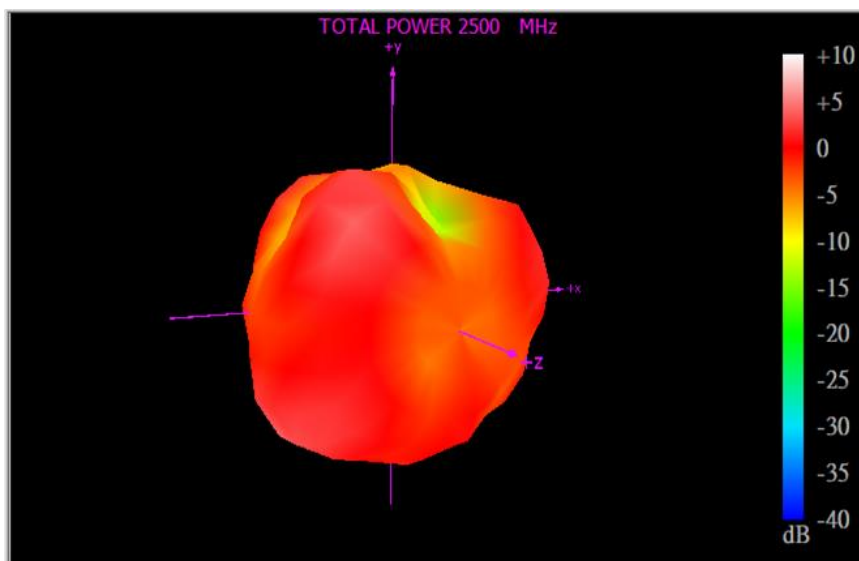
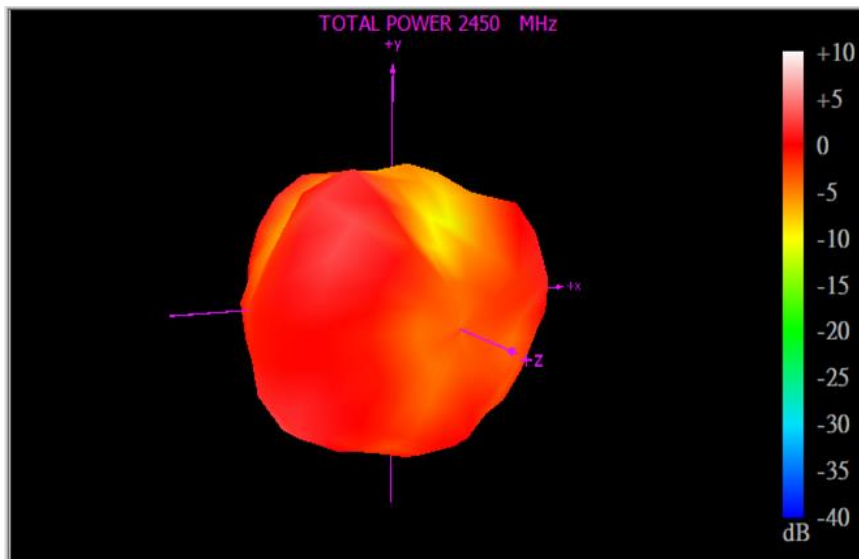
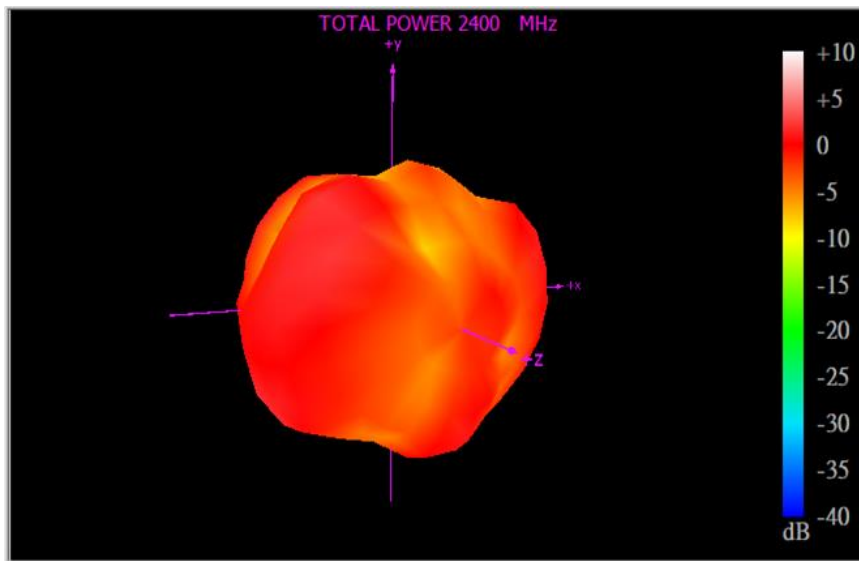

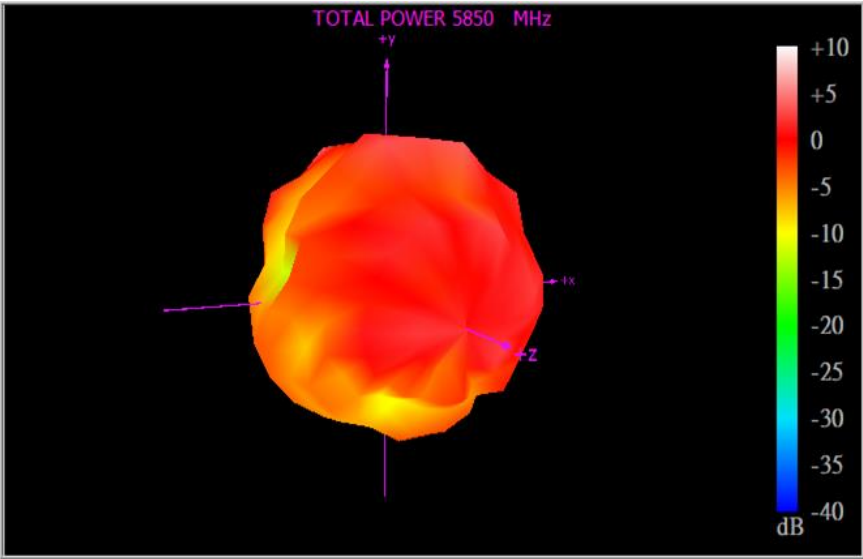
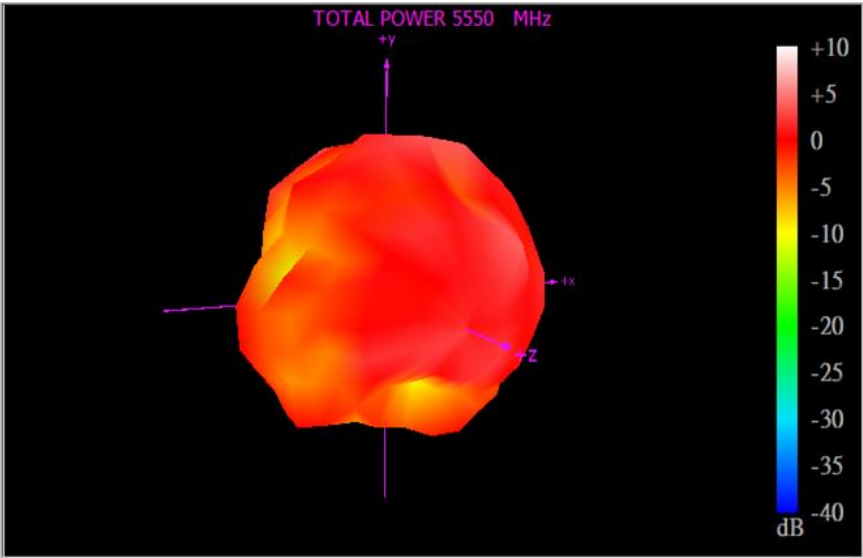
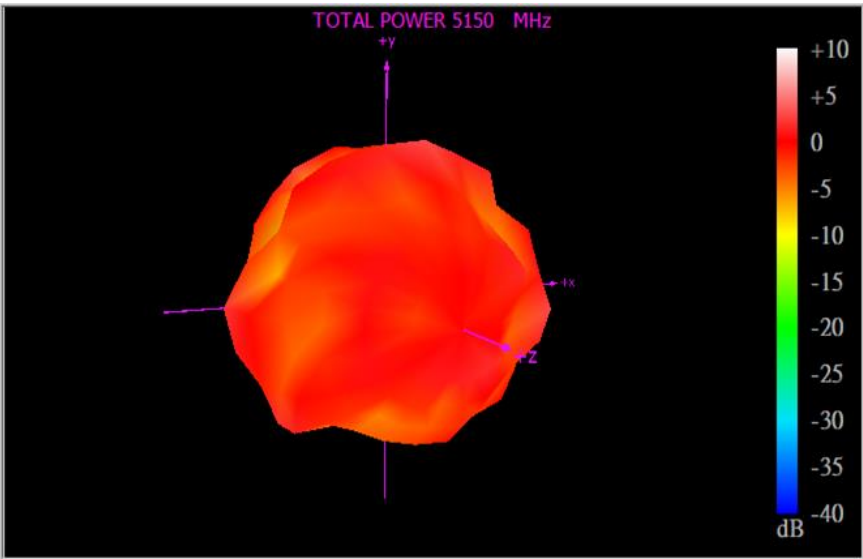

### 4.3.6 WIFI\_MIMO2

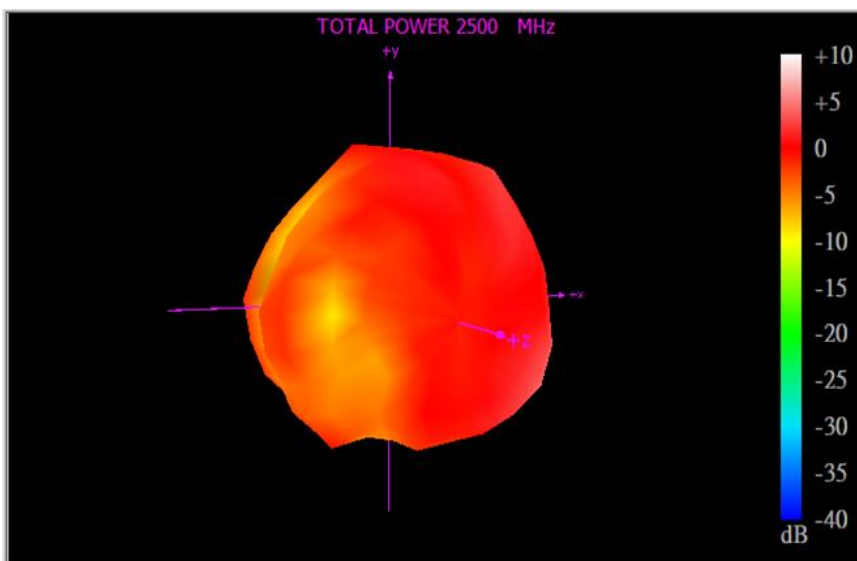
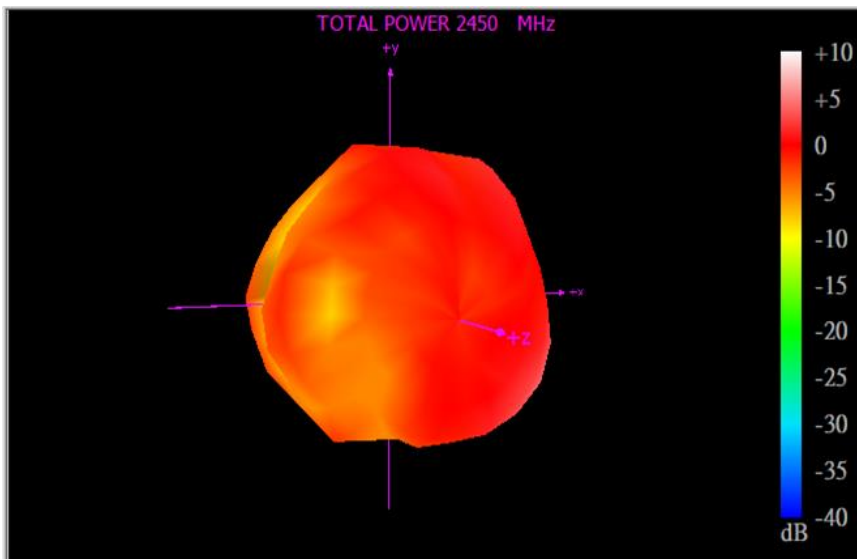
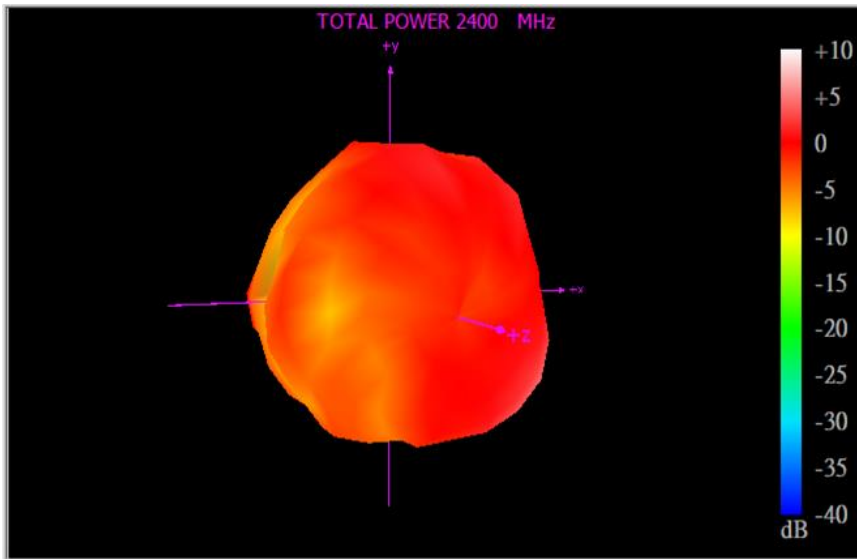

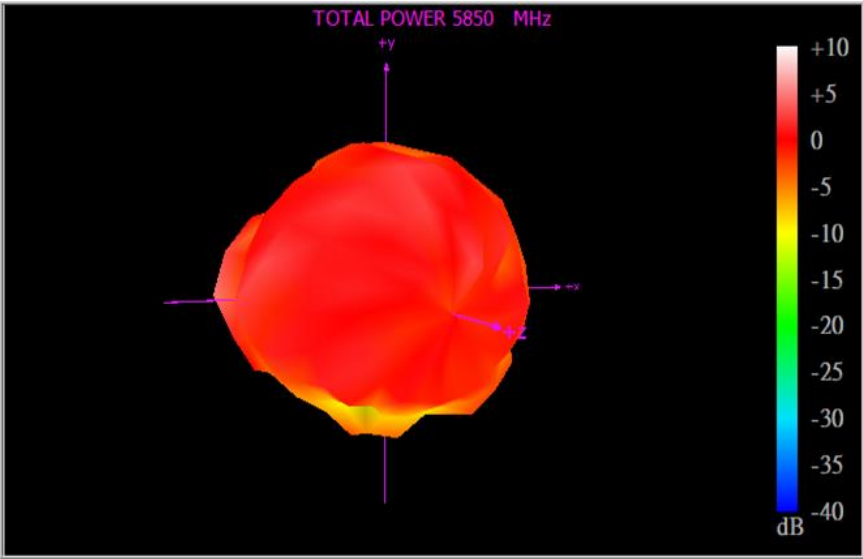
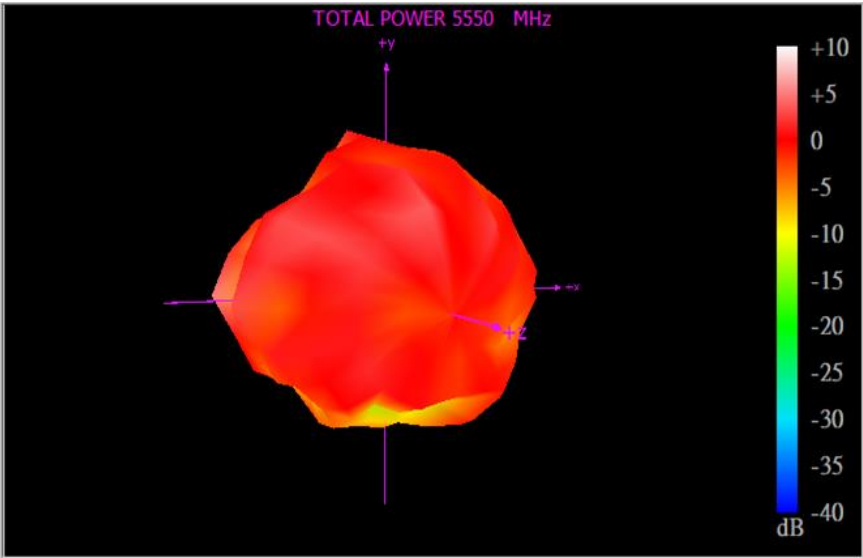
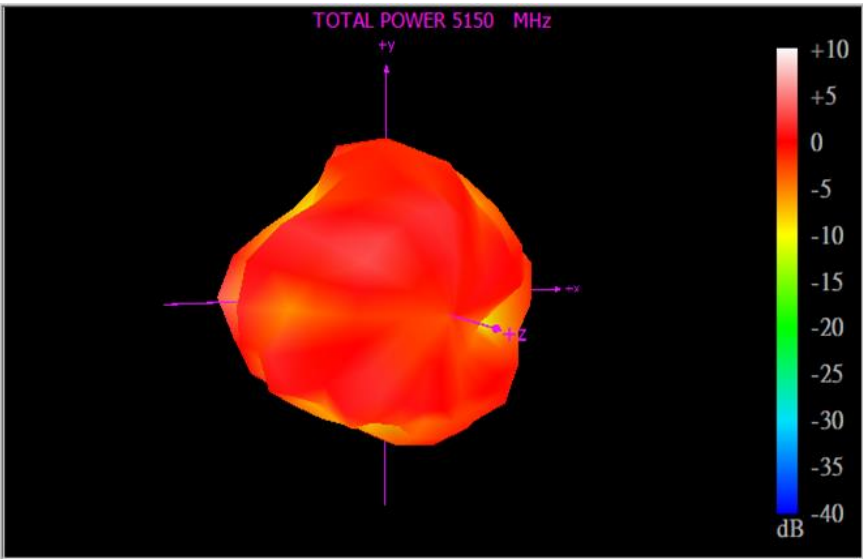

### 4.3.7 WIFI\_MIMO3

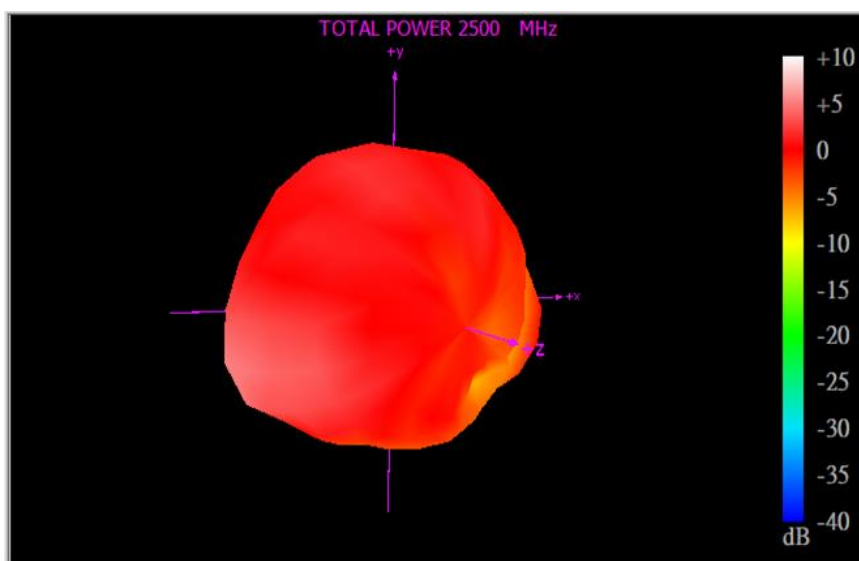
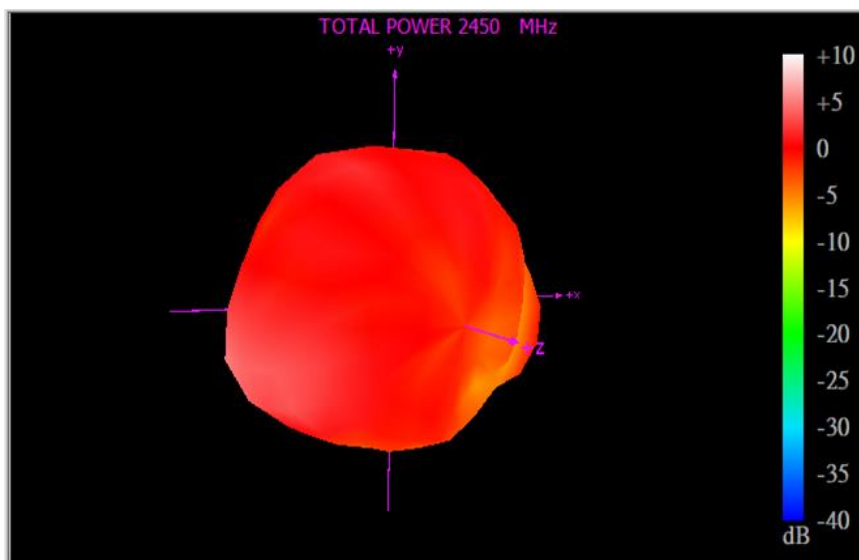
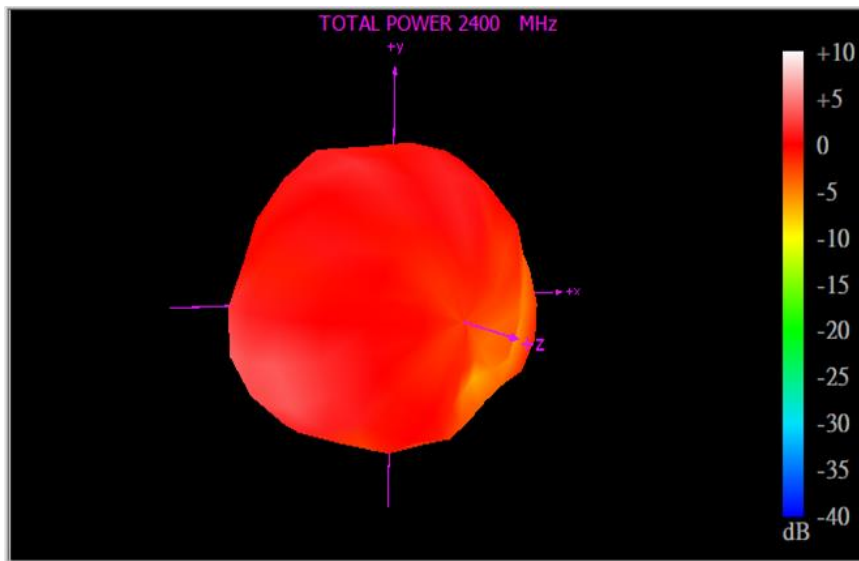

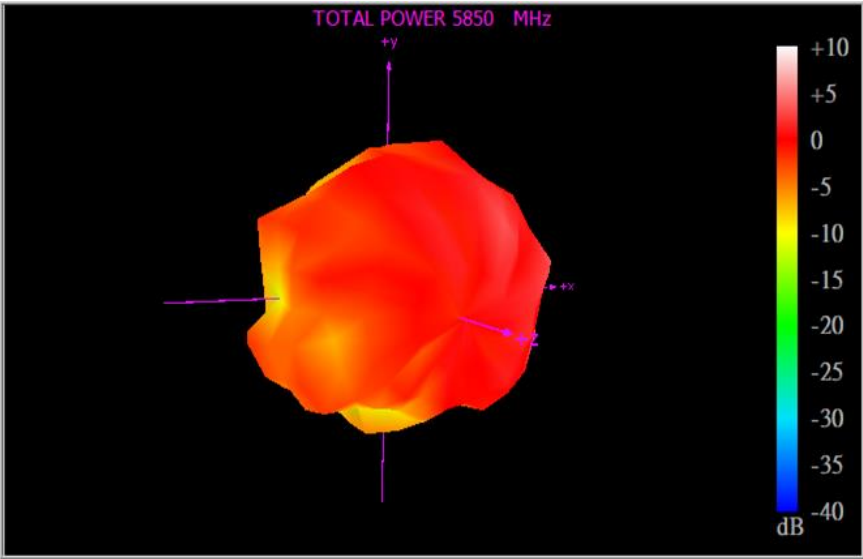
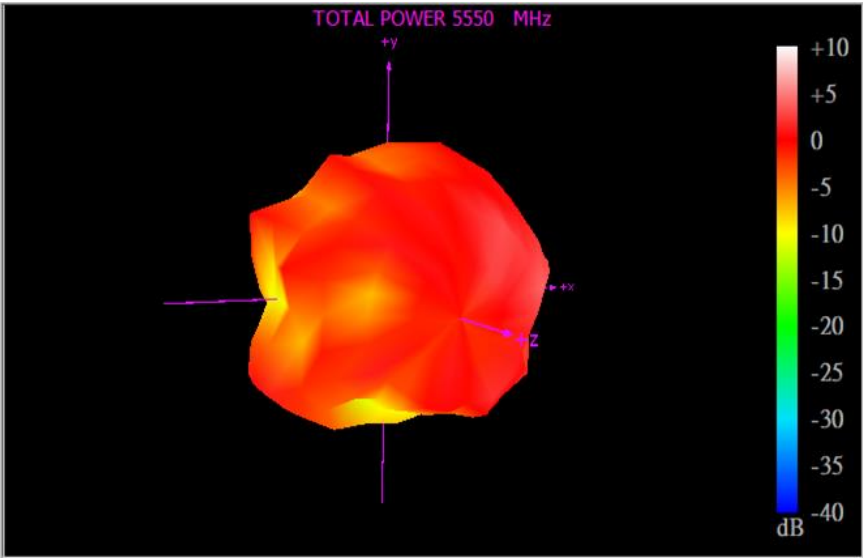
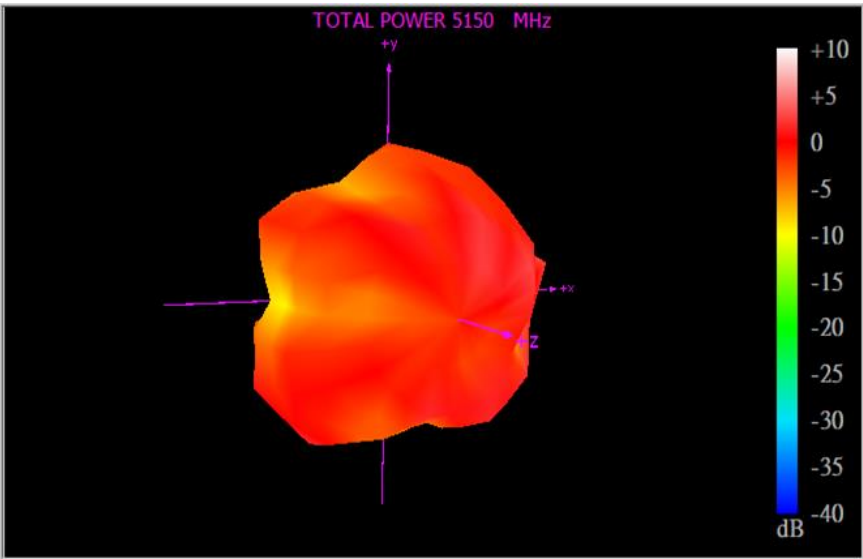

# 5. Drawing

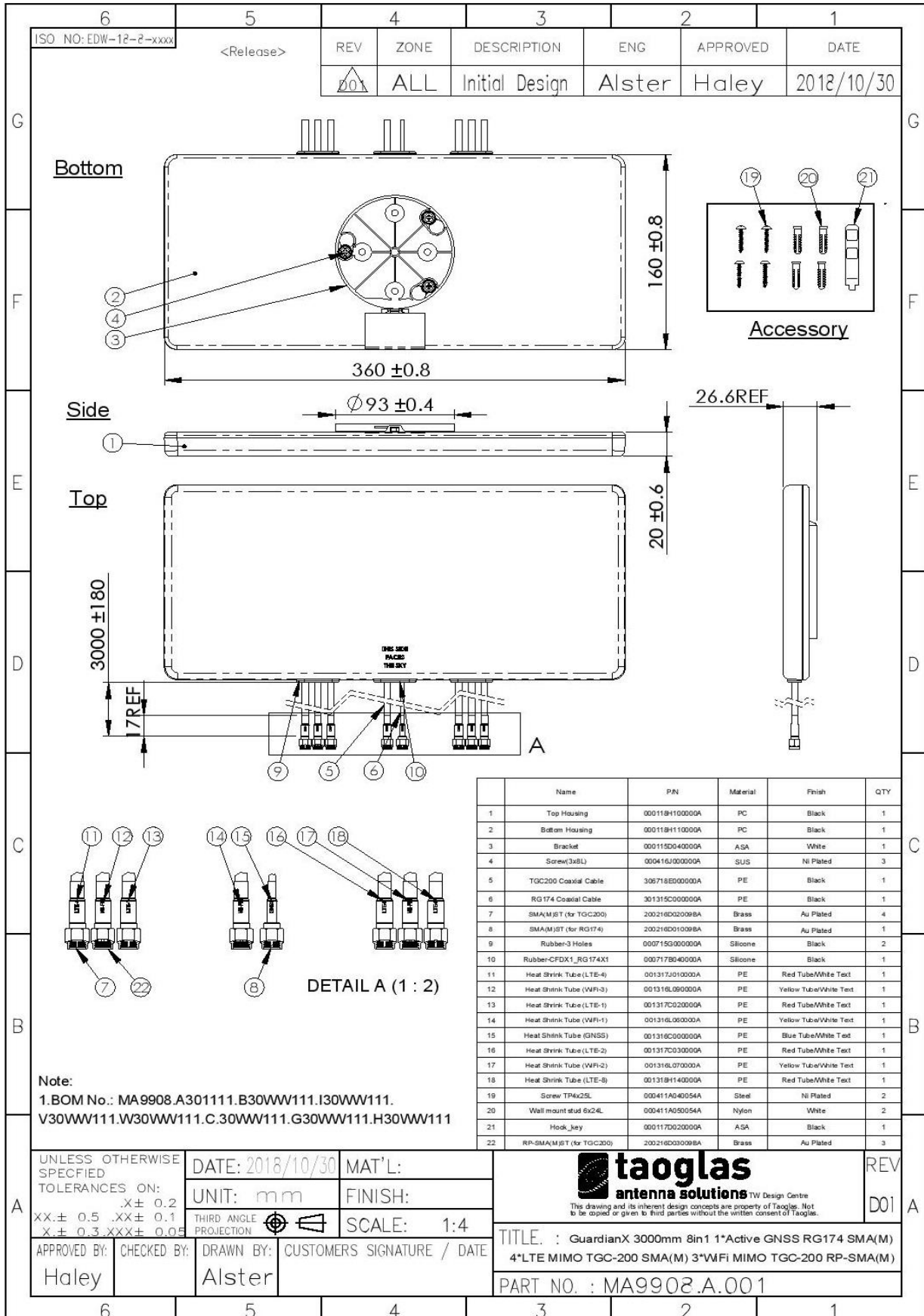



## 6. Packaging

1pc MA9908.A.001 per PE Bag  
 Bag Dimensions - 364\*524mm  
 Weight - 1.150Kg

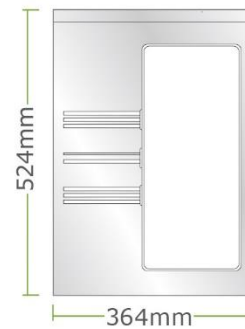

10pcs MA9908.A.001 per Carton  
 Carton Dimensions - 430\*380\*280mm  
 Weight - 12Kg

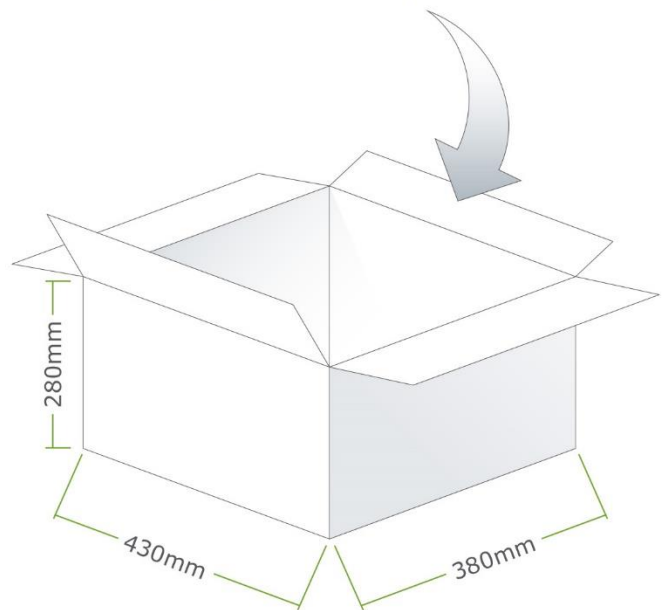

Pallet Dimensions:  
 1200mm\*1000mm\*1280mm  
 24 Cartons per Pallet  
 6 Cartons per Layer, 4 Layers

