

Digital Attenuator 1-Bit, 6 dB DC - 30 GHz



MAAD-011055-DIE

Rev. V1

Features

- 1 Bit Digital Attenuator
- Low Insertion Loss: 1.2 dB
- 6 dB Attenuation +/- 0.2 dB Step Error
- 50 Ω Impedance
- Bare Die
- RoHS* Compliant
- Chip Size: 645 x 605 μm

Applications

- Telecom Infrastructure
- Fiber Optics
- Phase Array Radars, Sensors
- Test Instruments
- Microwave Radio & VSAT
- General Purpose

Description

The MAAD-011055-DIE is a broadband bidirectional, 1-bit GaAs (pHEMT) digital step attenuator of 6 dB step size. Complementary 0 V and -5 V logic input is necessary to change the attenuators states from insertion loss to attenuation.

The MAAD-011055-DIE is part of a series of single bit digital attenuators covering the same frequency range and having the same physical size:

- MAAD-011053-DIE: 2 dB
- MAAD-011054-DIE: 4 dB
- MAAD-011056-DIE: 8 dB
- MAAD-011057-DIE: 10 dB

Functional Schematic

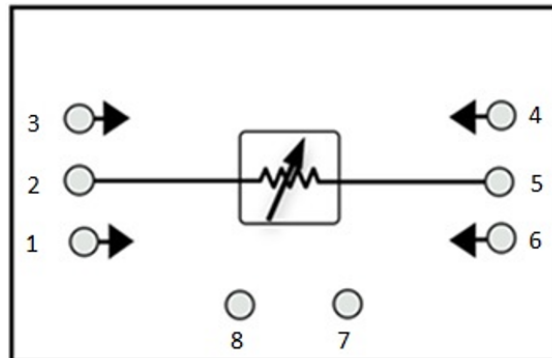

Pad Configuration¹

Pad #	Name	Function
1,3,4,6	GND	Ground
2	RF _{IN}	RF Input
5	RF _{OUT}	RF Output
7	VC2	Control Voltage 2
8	VC1	Control Voltage 1

1. GND bond pads 1,3,4 and 6 are connected to the backside of the die through via holes. Therefore, these bond pads may be left open.

Ordering Information

Part Number	Package
MAAD-011055-DIE	Gel Pack

* Restrictions on Hazardous Substances, compliant to current RoHS EU directive.

Electrical Specifications:

Freq. = DC - 30 GHz, $T_A = 25^\circ\text{C}$, $Z_0 = 50 \Omega$ (measured with 150 μm G-S-G RF probes)

Parameter	Test Conditions	Units	Min.	Typ.	Max.
Insertion Loss	6 GHz	dB	—	0.5	0.75
	18 GHz			0.7	1.2
	30 GHz			0.9	1.5
Attenuation	6 GHz	dB	5.60	6.4	7.10
	18 GHz		5.25	6.0	6.75
	30 GHz		4.60	5.4	6.10
Return Losses	RF Input RF Output	dB	—	17 17	—
Input IP3	Two-tone, 10 MHz, +5 dBm	dBm	—	40	—
T_{RISE} T_{FALL}	10% RF to 90% RF 90% RF to 10% RF	ns	—	10 35	—
T_{ON} T_{OFF}	50% Control to 90% RF 50% Control to 10% RF	ns	—	15 40	—
VC1, VC2	LOW-level input voltage HIGH-level input voltage	V	-5.5 -0.2	-5 0	-3 0.2
I_{VC} (Input Control Currents)	$V_C = -5 \text{ V}$ or 0 V	μA	—	1	—

Truth Table²

VC1	VC2	Attenuation
0	1	Insertion Loss
1	0	6 dB

2. "0" = -5 V; "1" = 0 V.

Maximum Operating Conditions

Parameter	Maximum
Input Power	27 dBm
VC1 and VC2	-5.5 V to +0.2 V
Operating Temperature	-40°C to +85°C

Handling Procedures

Please observe the following precautions to avoid damage:

Static Sensitivity (ESD Rating)

These electronic devices are sensitive to electrostatic discharge (ESD) and can be damaged by static electricity. Proper ESD control techniques should be used when handling these devices. This device has a CLASS 0 ESD rating

Absolute Maximum Ratings^{3,4}

Parameter	Absolute Maximum
Input Power	30 dBm
VC1 and VC2	-6 V to +0.5 V
Storage Temperature	-65°C to +150°C

- Exceeding any one or combination of these limits may cause permanent damage to this device.
- MACOM does not recommend sustained operation near these survivability limits.

Digital Attenuator 1-Bit, 6 dB DC - 30 GHz



MAAD-011055-DIE

Rev. V1

Typical Performance Curves: measured with 150 μm G-S-G RF probes

Insertion Loss, over temperature

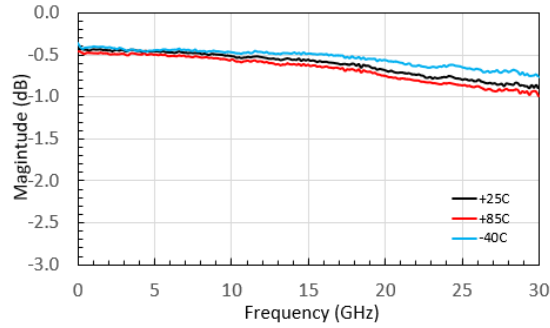

Relative Attenuation & Temperature

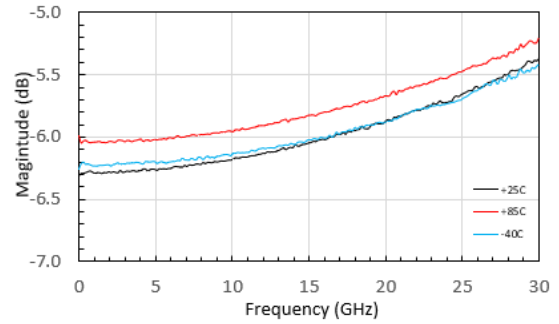

Input Return Loss, over Temperature

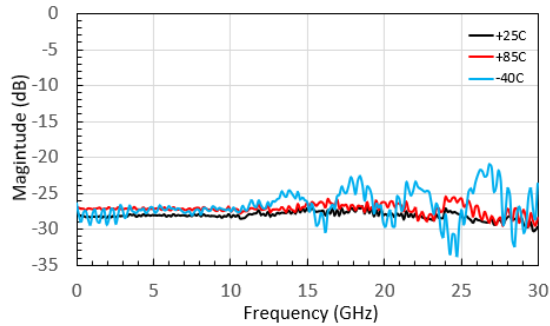

Input Power Compression (Insertion Loss @ 15 GHz)

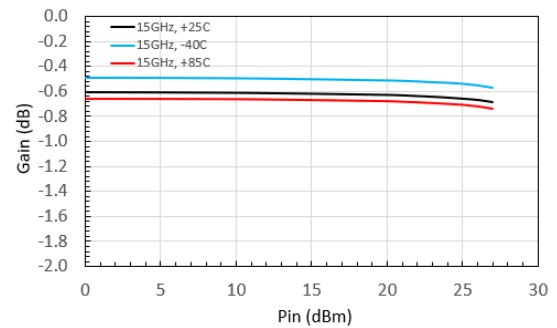

Output Return Loss, over Temperature

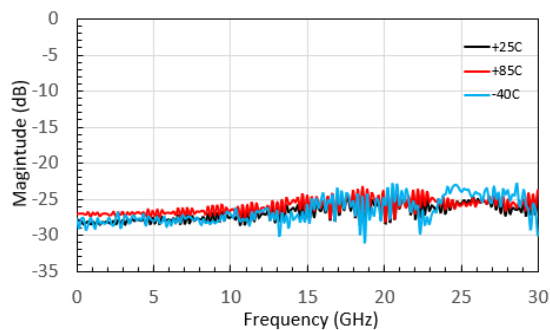

Input IP3, Insertion Loss and Attenuation States

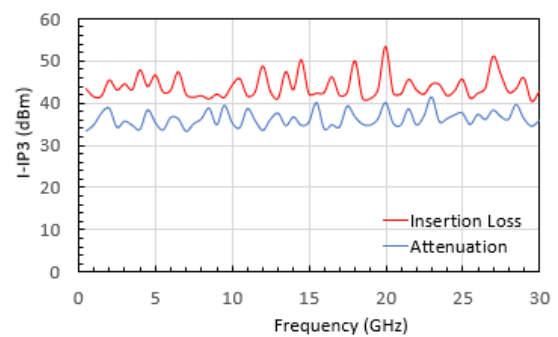

Recommended Mounting & Wire-Bonding

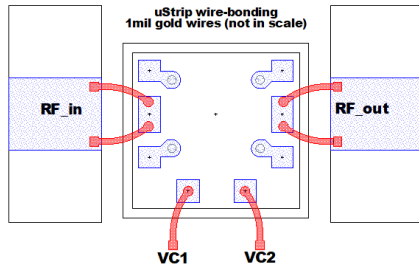

(a) Recommended Microstrip wire bonding

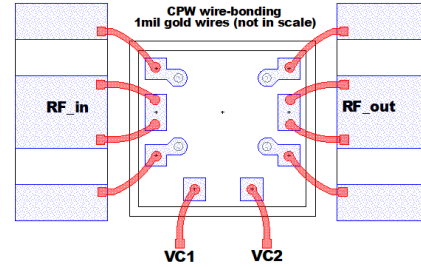

(b) Recommended CPW wire bonding

The DIE should be directly attached to the RF/DC ground plane; either with solder (AuSn) or a thin application of conductive epoxy. Avoid overflows.

The 50 Ω microstrip, or 50 Ω CPW transmission lines should be brought up as close as possible to the die in order to minimize the connecting wire bonds inductances.

A typical spacing between die and microstrip substrate should be kept between 75 - 125 μm for best RF behavior. All bonds should be kept as short as possible. Use minimum ultrasonic energy for reliable wire bonds.

Two bond wires are recommended for the RF ports as shown above. Simultaneously, it is recommended to have the height of the die at the same height of the transmission's line substrate. Do not exceed a substrate height of 10 mils for the transmission lines used. A pedestal may be needed to lift the chip to the level of the 50 Ω T-Line.

If CPW transmission lines are used, make sure that the ground planes of the CPW structure are wire bonded to the ground pads (G-S-G) on the DIE as shown above.

DIE Outline^{5,6,7}

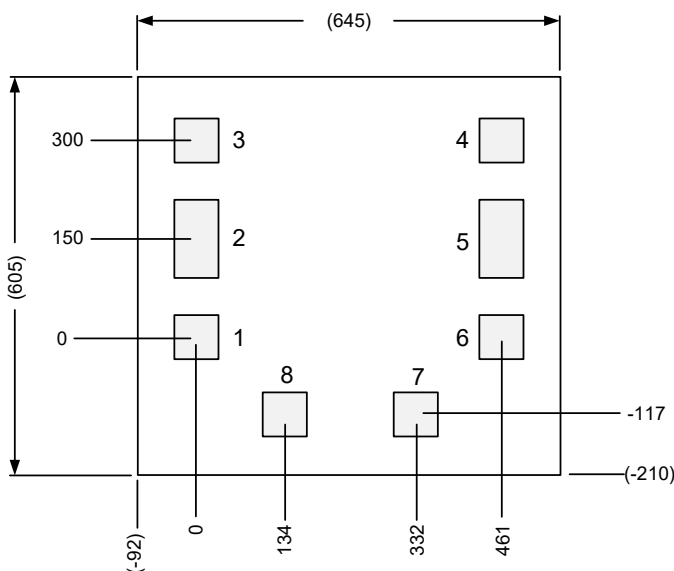

Bond Pad Size (μm)

Pad #	X (μm)	Y (μm)	Pad Label
1,3,4,6	67	67	Ground
2	67	117	RF Input
5	67	117	RF Output
7	70	70	Control Voltage 2
8	70	70	Control Voltage 1

- 5. Unless otherwise specified, all dimensions are in μm with a tolerance of ±5 μm.
- 6. Die thickness is 100 ±10 μm.
- 7. Die size reflects cut dimensions. Die size is reduced by 25 μm each dimension.