

## Digital Attenuator, 1-Bit, Single Control 21 dB, 0.8 - 8.0 GHz

M/A-COM Products  
Rev. V2

### Features

- 21 dB Step Attenuator
- Positive Control: 2.5 V typical
- Insertion Loss: 0.75 dB typical @ 2.0 GHz
- Current Consumption: 40  $\mu$ A typical
- IP3: >42 dBm typical @ 2.0 GHz
- Lead-Free 2mm 8-Lead PDFN Package
- Halogen-Free "Green" Mold Compound
- RoHS\* Compliant and 260°C Re-flow Compatible

### Description

M/A-COM's MAADSS0012 is a 1-bit, 21 dB step attenuator. This GaAs MMIC digital attenuator is packaged in an ultra small lead free 2 mm 8-Lead PDFN surface mount package.

The MAADSS0012 digital attenuator will work with any power source operating between 2.8 and 5.0 volts. This single bit attenuator is ideally suited for use in wide band systems, up to 8.0 GHz where good linearity and low insertion loss are required.

Typical applications for the MAADSS0012 attenuator include WiMAX (802.16), Mesh Networks, Multi-band repeaters and other linear systems.

### Functional Schematic <sup>3</sup>

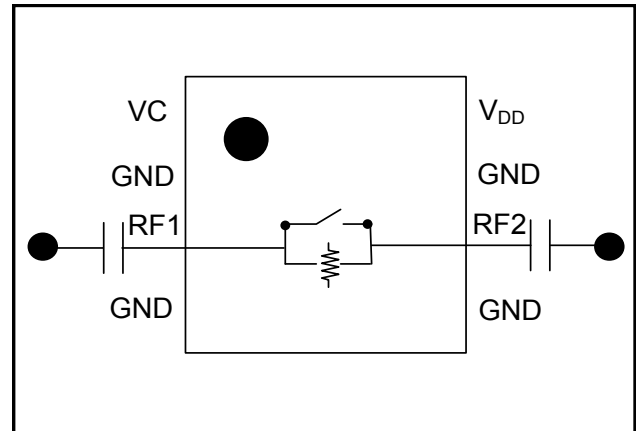

3. Blocking capacitors are required on all RF ports.

### Pin Configuration

Pin No.	Function	Pin No.	Function
1	V <sub>C</sub>	5	Ground
2	Ground	6	RF In/Out
3	RF In/Out	7	Ground
4	Ground	8	V <sub>DD</sub>

### Ordering Information <sup>1,2</sup>

Part Number	Package
MAADSS0012TR-3000	3000 piece reel
MAADSS0012SMB	Sample Test Board

1. Reference Application Note M513 for reel size information.
2. All sample boards include 5 loose parts.

### Absolute Maximum Ratings <sup>4,5</sup>

Parameter	Absolute Maximum
Input Power 0.8 - 8.0 GHz V <sub>DD</sub> = 2.8 - 5.0 V	+33 dBm
Control Voltage	-0.5 V $\leq$ V <sub>C</sub> $\leq$ 5.0 V
Operating Temperature	-40°C to +85°C
Storage Temperature	-65°C to +150°C

4. Exceeding any one or combination of these limits may cause permanent damage to this device.
5. M/A-COM does not recommend sustained operation near these survivability limits.

\* Restrictions on Hazardous Substances, European Union Directive 2002/95/EC.

## Digital Attenuator, 1-Bit, Single Control 21 dB, 0.8 - 8.0 GHz

M/A-COM Products  
Rev. V2

Electrical Specifications <sup>6</sup>:  $T_A = 25^\circ\text{C}$ ,  $Z_0 = 50\ \Omega$ ,  $V_C = 2.5\ \text{V}$ ,  $V_{DD} = 2.8\ \text{V}$

Parameter	Test Conditions	Units	Min.	Typ.	Max.
Reference Insertion Loss	2.0 GHz	dB	—	0.75	1.0
Attenuation	2.0 GHz	dB	20	21	22
Return Loss	2.0 - 8.0 GHz	dB	—	20	—
Trise, Tfall	10% to 90% RF, 90% to 10% RF	ns	—	50	—
Ton, Toff	50% Control to 90% RF, 50% Control to 10% RF	ns	—	200	—
Transients	In Band	mV	—	20	—
1 dB Compression	Input Power, 0.8 - 8.0 GHz	dBm	—	25	—
IP <sub>2</sub>	2.0 - 8.0 GHz Measured Relative to Input (for two-tone Input Power up to +5 dBm)	dBm	—	70	—
IP <sub>3</sub>	2.0 - 8.0 GHz Measured Relative to Input (for two-tone Input Power up to +5 dBm)	dBm	—	42	—
I <sub>c</sub>	V <sub>C</sub> = 2.5 V	μA	—	15	20
I <sub>DD</sub>	V <sub>DD</sub> = 2.8 V	μA	—	40	60

6. External DC blocking capacitors are required on all RF ports. Loss varies at 0.003 dB/°C.

### Recommended Configuration

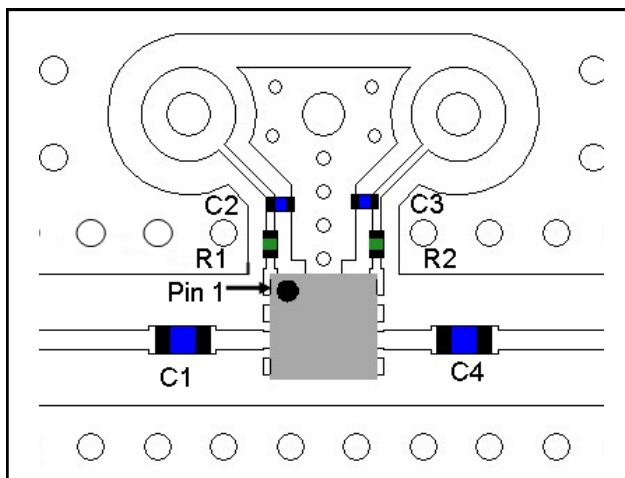

### Parts List

Part	Value	Case Style	Manufacturer
C1, C4	15 pF	0402	Murata
C2, C3	47 pF	0201	Murata
R1, R2	10K $\Omega$	0201	Panasonic

### Truth Table <sup>7</sup>

VC	Attenuation (dB)
0	Reference IL
1	21

7. 0 = 0 ± 0.2 V, 1 = +2.5 to 5 V, minimum 2.5 V delta.

## Typical Performance Curves

**Insertion Loss**

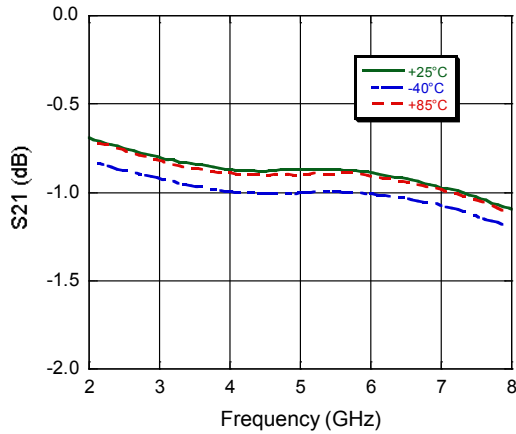

**Relative Attenuation**

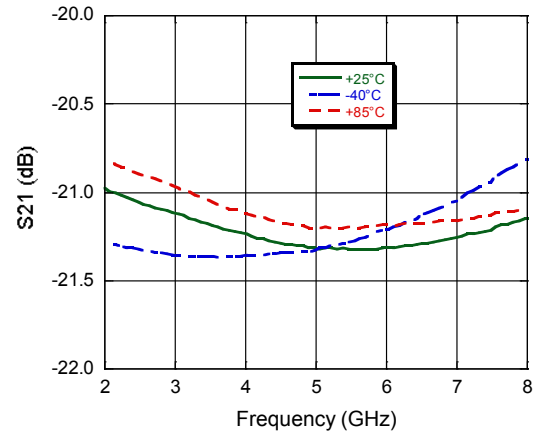

**Input Return Loss, Insertion Loss State**

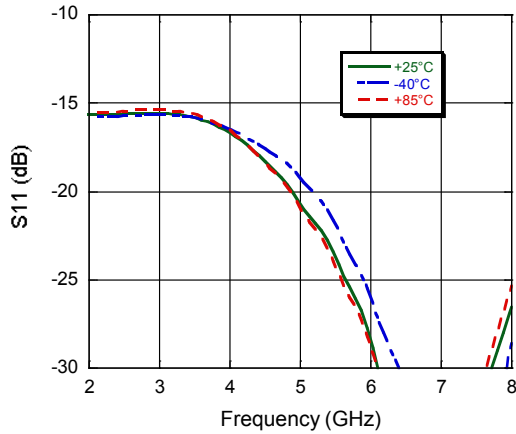

**Input Return Loss, Attenuation State**

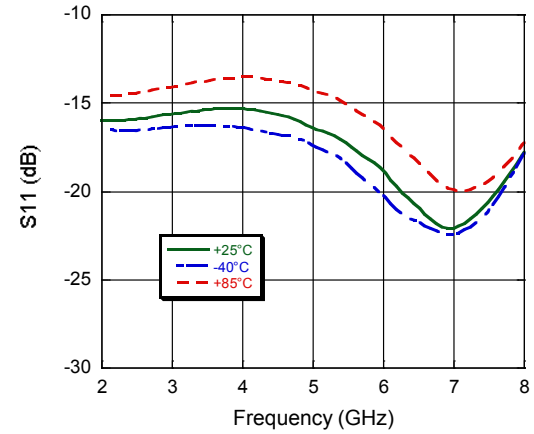

**Output Return Loss, Insertion Loss State**

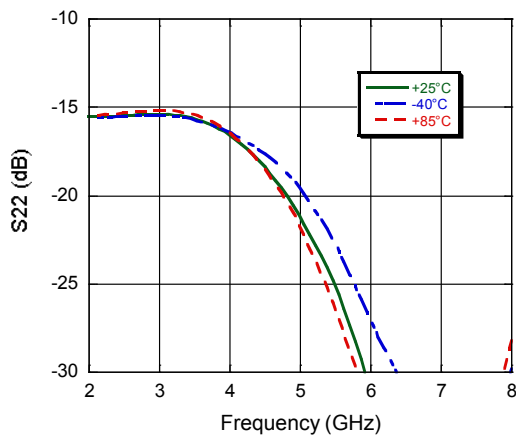

**Output Return Loss, Attenuation State**

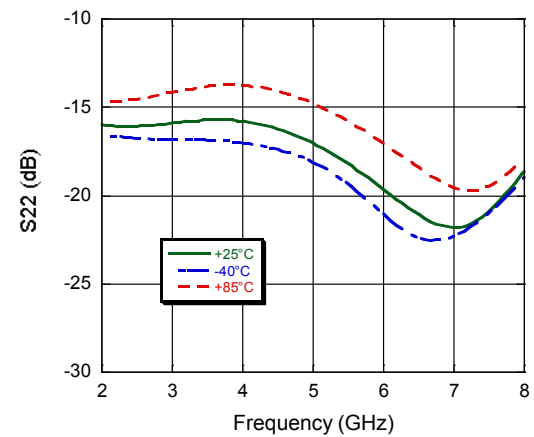

## Typical Performance Curves

**IP3**

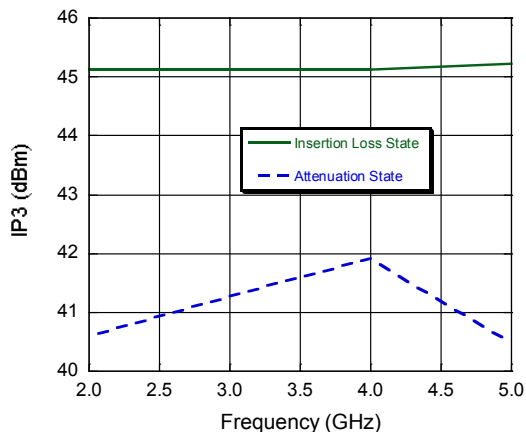

**IP2**

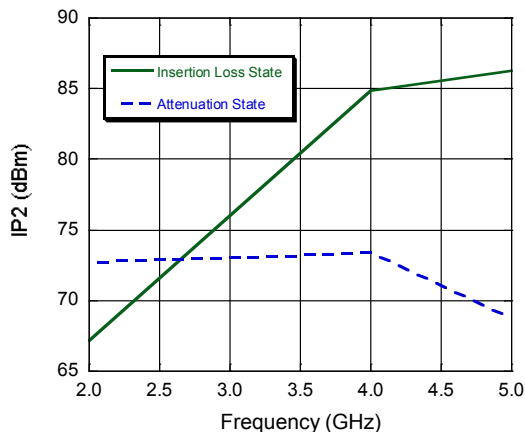

## Handling Procedures

Please observe the following precautions to avoid damage:

## Static Sensitivity

Gallium Arsenide Integrated Circuits are sensitive to electrostatic discharge (ESD) and can be damaged by static electricity. Proper ESD control techniques should be used when handling these devices.

## Lead-Free 2 mm 8-Lead PDFN<sup>†</sup>

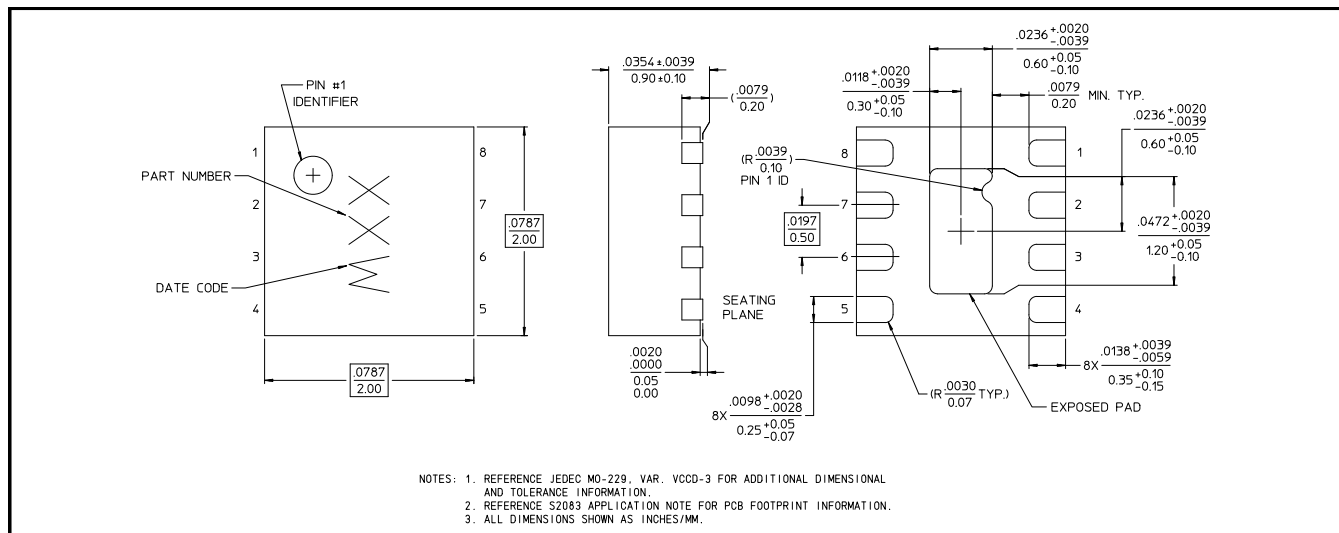

<sup>†</sup> Reference Application Note S2083 for lead-free solder reflow recommendations.  
 Meets JEDEC moisture sensitivity level 1 requirements.  
 Plating is 100% matte tin over copper.

## Applications Section—Low Frequency Measurement

**Insertion Loss**

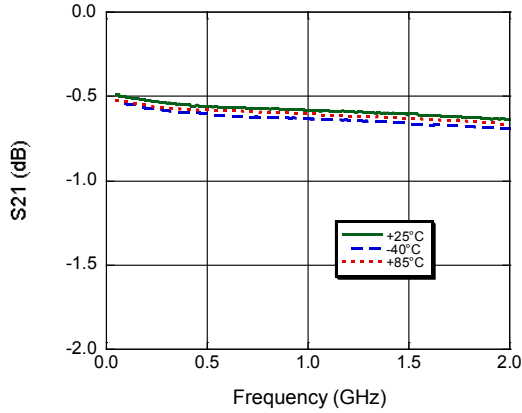

**Relative Attenuation**

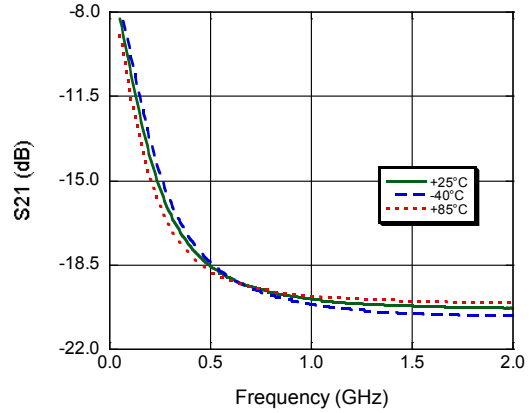

**Input Return Loss—Insertion Loss State**

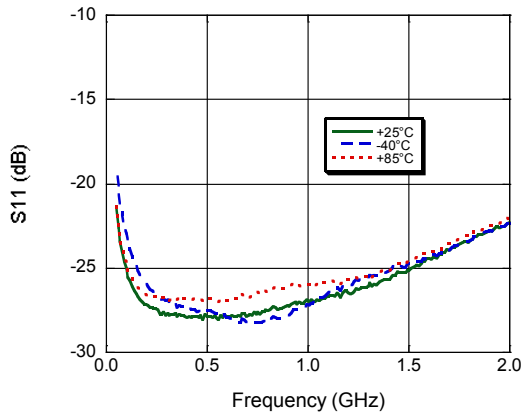

**Input Return Loss—Attenuation State**

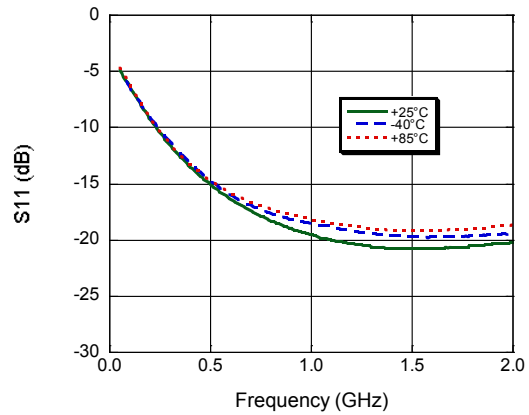

**Output Return Loss—Insertion Loss State**

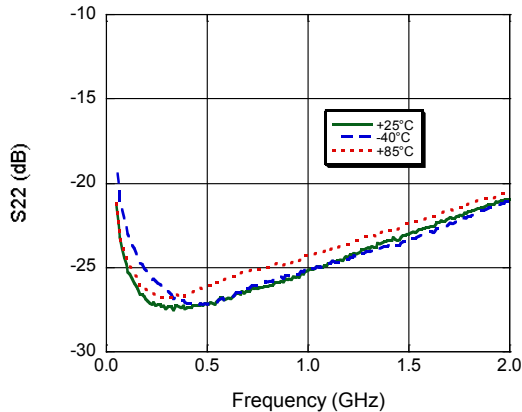

**Output Return Loss—Attenuation State**

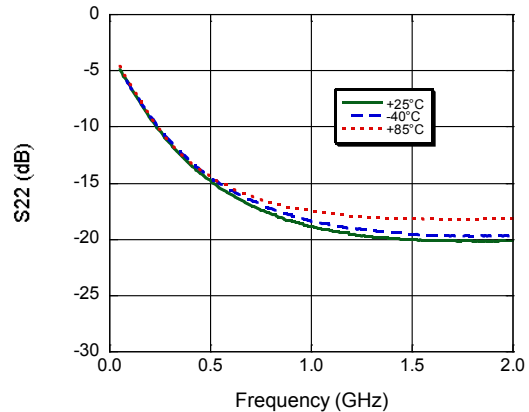

This data shows the MAADSS0012 with the board and connector loss removed.

M/A-COM recommends using DC-Blocking capacitors large enough that their  $X_c$  is insignificant at the frequency of use. At 800 MHz a capacitor value greater than 1000 pF is recommended.