

## Features

- Low Noise Figure
- Excellent Input Return Loss
- Single Voltage Bias 3 V
- Integrated Active Bias Circuit
- Current Adjustable 20 - 80 mA with an External Resistor
- High Linearity, OIP3 >32 dBm
- Small Package: 2 mm PDFN-8LD
- RoHS\* Compliant

## Description

The MAAL-010705 is a high dynamic range single stage MMIC LNA with excellent linearity and low noise figure designed for operation from 0.5 to 1.6 GHz. The LNA is packaged in an RoHS compliant leadless 2 mm 8-lead PDFN package.

This MMIC has an integrated active bias circuit allowing direct connection to 3 V voltage supply and minimizing variation over temperature and process. The bias current and gain can be set with external resistors to allow the user to customize the current and gain value to fit the application.

The MAAL-010705 offers less than 0.7 dB noise figure, more than 32 dBm OIP3 and 20 dB input return loss. The excellent input match, low noise figure and high OIP3 along with the flexibility of setting current and gain make this LNA ideal for 3G and 4G cellular infrastructure applications.

For optimum performance above 1.6 GHz the MAAL-010706 is recommended. The MAAL-010705 and MAAL-010706 share the package type and footprint.

## Functional Block Diagram

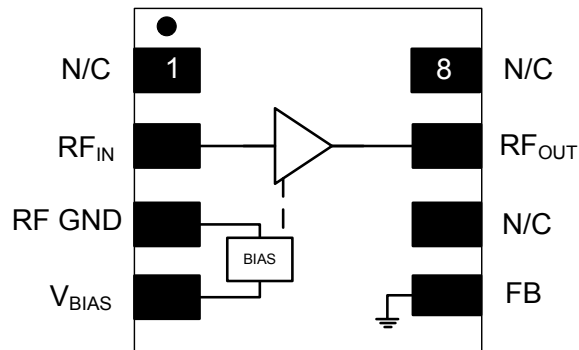

## Pin Configuration

Pin No.	Pin Name	Description
1	N/C	No Connection
2	RF <sub>IN</sub>	RF Input
3	RF GND	RF Ground
4	V <sub>BIAS</sub>	Bias Voltage
5	FB	Feedback
6	N/C	No Connection
7	RF <sub>OUT</sub>	RF Output
8	N/C	No Connection

## Ordering Information <sup>1,2</sup>

Part Number	Package
MAAL-010705-TR3000	tape and reel
MAAL-010705-001SMB	evaluation board

1. Reference Application Note M513 for reel size information.
2. All sample boards include 5 loose parts.

\* Restrictions on Hazardous Substances, European Union Directive 2011/65/EU.

**Electrical Specifications<sup>3</sup>: Freq = 0.9 GHz,  $V_D = 4$  V,  $T_A = +25^\circ\text{C}$ ,  $Z_0 = 50 \Omega$**

Parameter	Test Conditions	Units	Min.	Typ.	Max.
Gain	—	dB	18	21	—
Output IP3	$P_{OUT} = 5$ dBm, Tone Spacing = 1 MHz	dBm	—	32	—
Output P1dB	—	dBm	17.5	18.5	—
Input Return Loss	—	dB	—	19	—
Output Return Loss	—	dB	—	18	—
Noise Figure	—	dB	—	0.50	—
Total Current	$I_{DQ} = I_D + I_{BIAS}$	mA	—	60	70

3.  $V_D$  and  $V_{BIAS}$  are connected together to +4 V,  $R3 = 150 \Omega$  and  $R4 = 240 \Omega$ , reference recommended schematic on page 8.

**Absolute Maximum Ratings<sup>4,5</sup>**

Parameter	Rating
Supply Voltage	5.5 V
Current	100 mA
Power Dissipation	600 mW
RF Input Power	20 dBm
Storage Temperature	$-55^\circ\text{C}$ to $+150^\circ\text{C}$
Operating Temperature	$-40^\circ\text{C}$ to $+85^\circ\text{C}$
Junction Temperature <sup>6</sup>	$+150^\circ\text{C}$

4. Exceeding any one or combination of these limits may cause permanent damage to this device.
5. MACOM does not recommend sustained operation near these survivability limits.
6. Typical thermal resistance ( $\Theta_{jc}$ ) =  $45^\circ\text{C/W}$ .

**Handling Procedures**

Please observe the following precautions to avoid damage:

**Static Sensitivity**

Gallium Arsenide Integrated Circuits are sensitive to electrostatic discharge (ESD) and can be damaged by static electricity. Proper ESD control techniques should be used when handling these class 1A devices.

## Low Noise Amplifier 0.5 - 1.6 GHz

Rev. V2

### Typical Performance Curves: 4 V (over current)

Input Return Loss

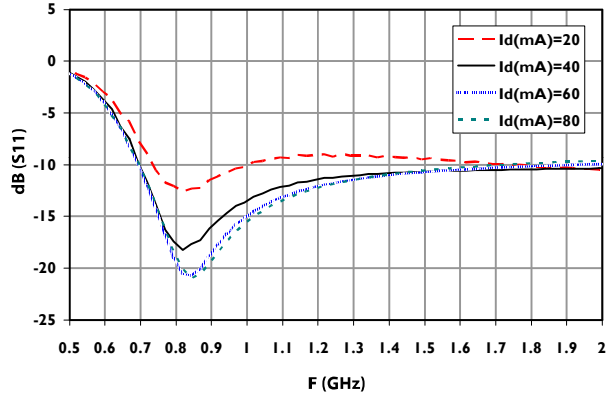

Output Return Loss

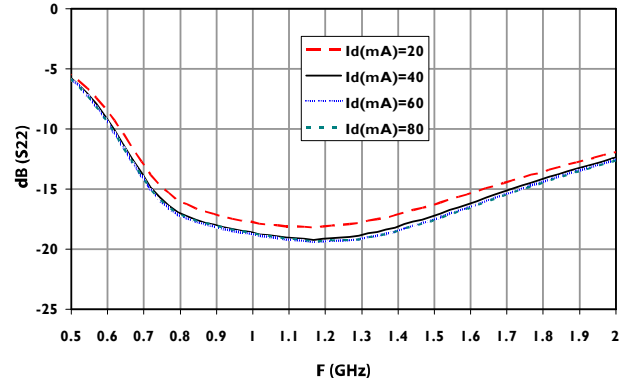

Gain

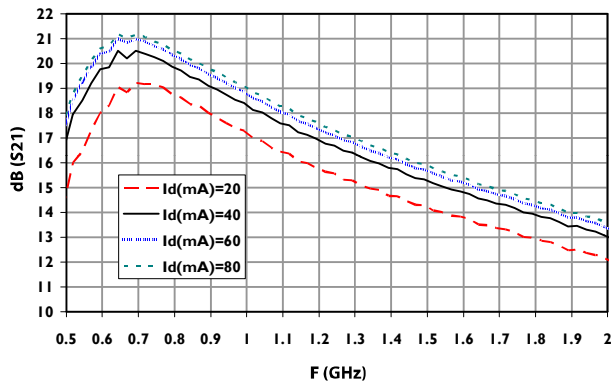

Noise Figure

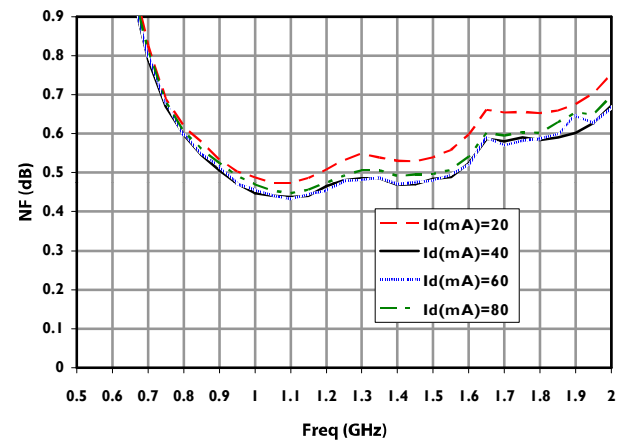

OIP3

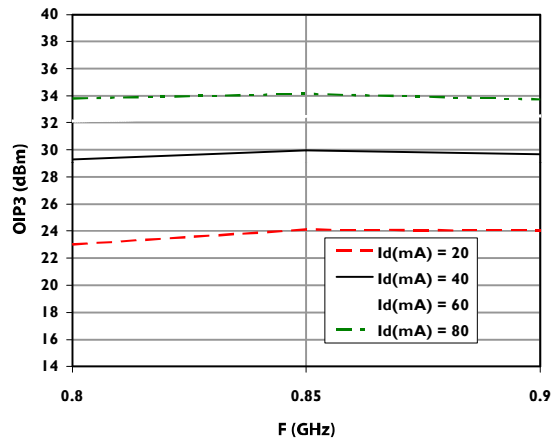

P1dB

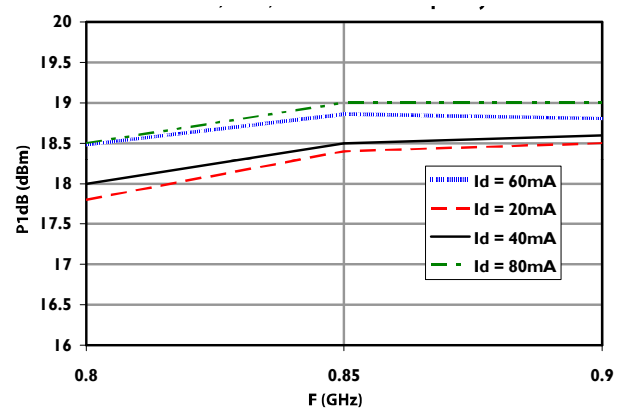

## Low Noise Amplifier 0.5 - 1.6 GHz

Rev. V2

### Typical Performance Curves: 4 V (over R3)

Gain

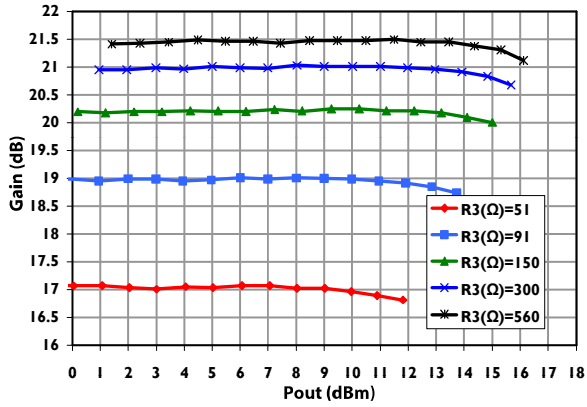

Noise Figure & Fmin

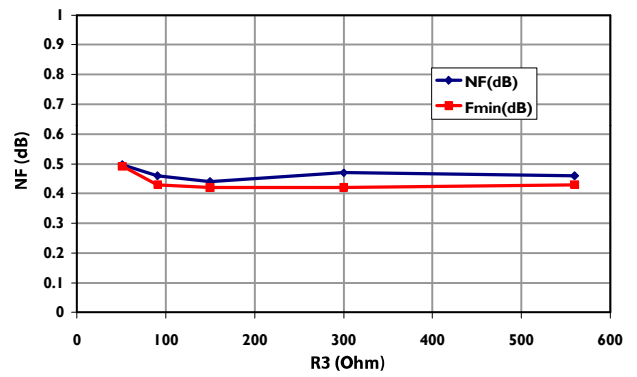

OIP3

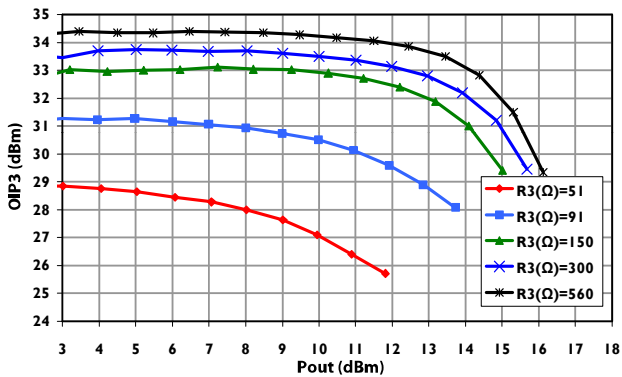

P1dB

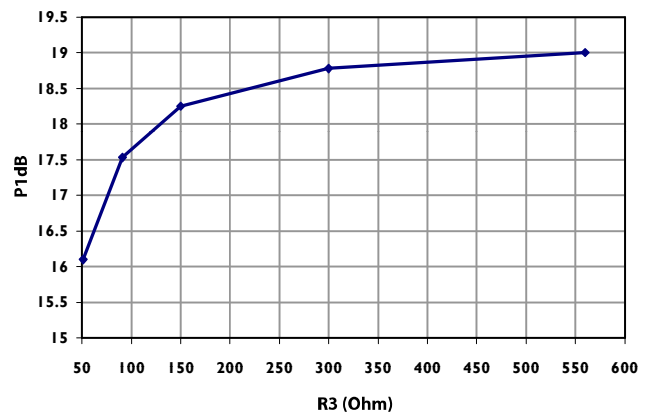

## Low Noise Amplifier 0.5 - 1.6 GHz

Rev. V2

### Typical Performance Curves: 4 V (over temperature)

**Input Return Loss**

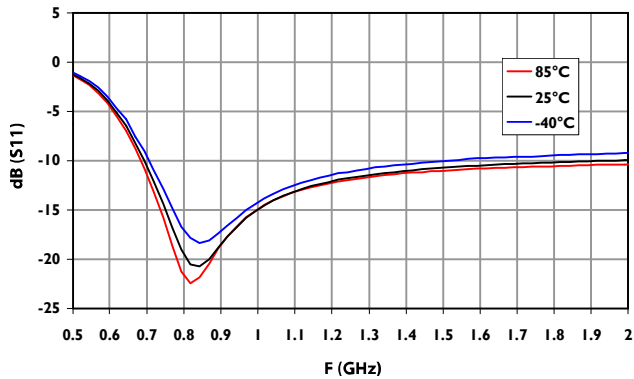

**Output Return Loss**

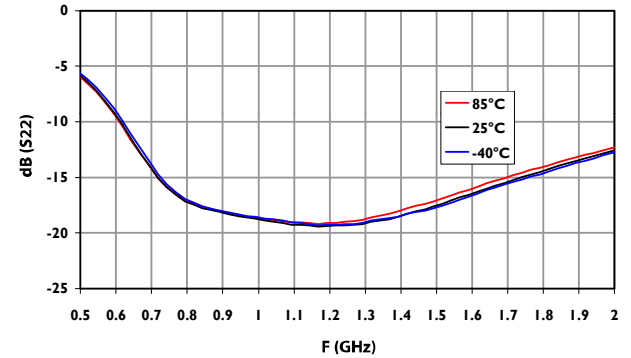

**Gain**

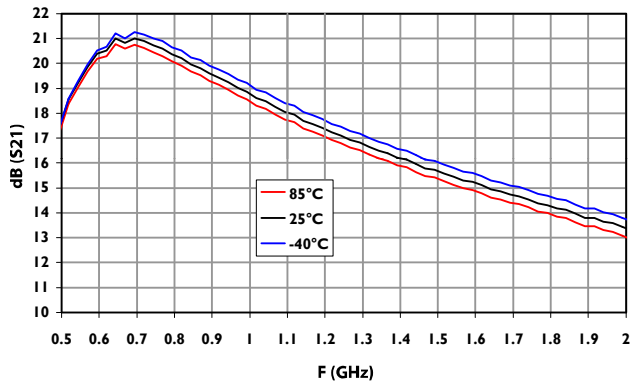

**Noise Figure**

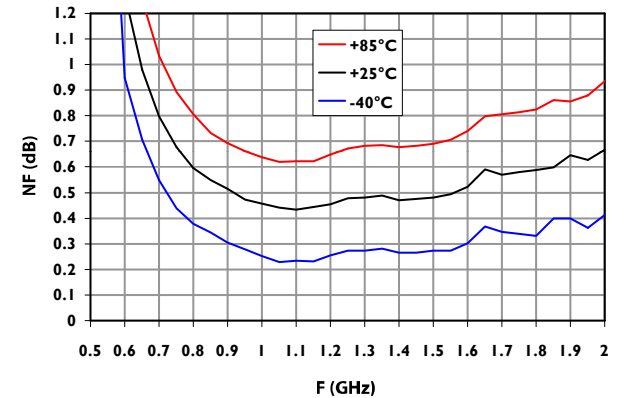

**OIP3**

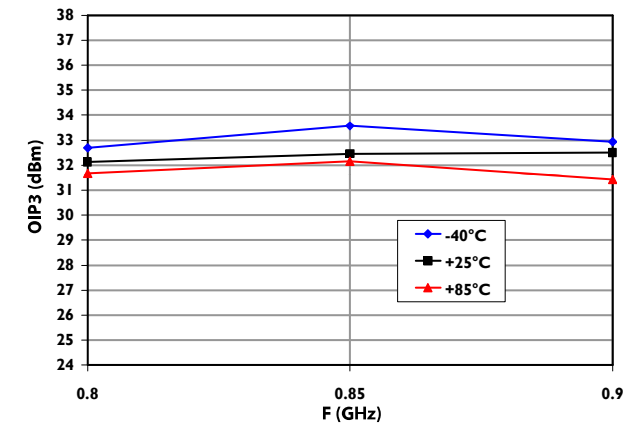

**P1dB**

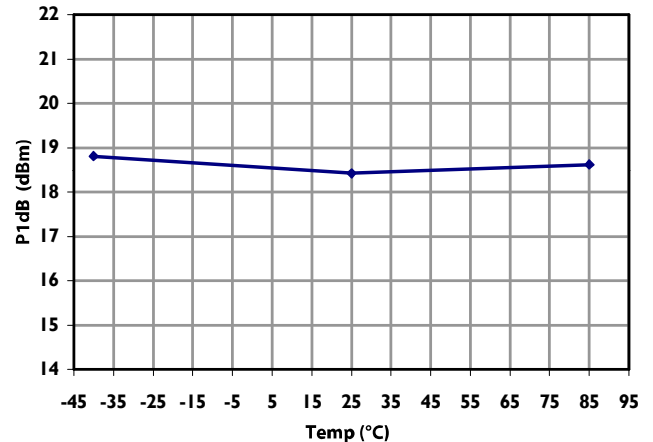

## Typical Performance Curves: 3 V

Input Return Loss

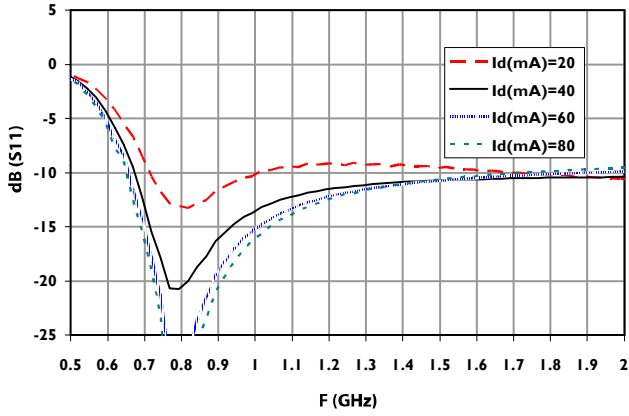

Output Return Loss

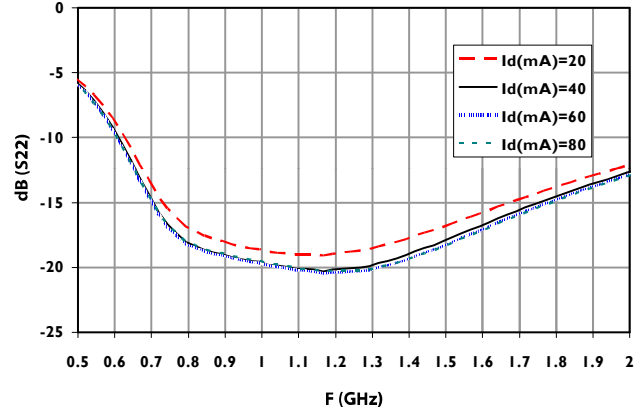

Gain

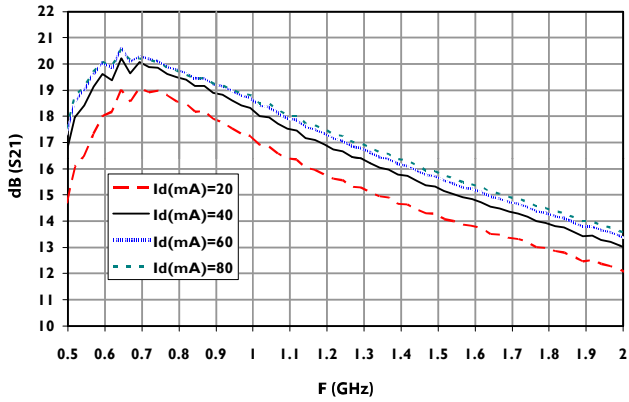

Noise Figure

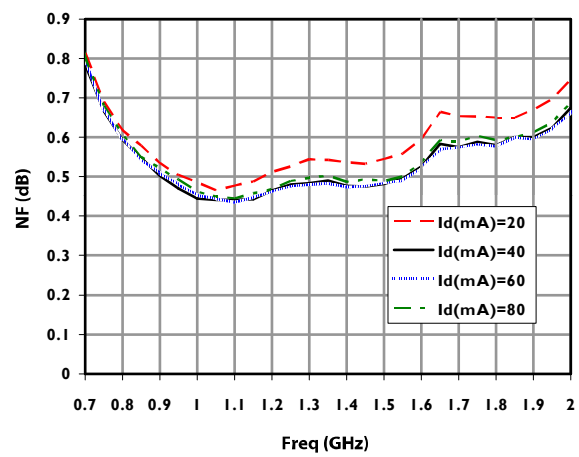

OIP3

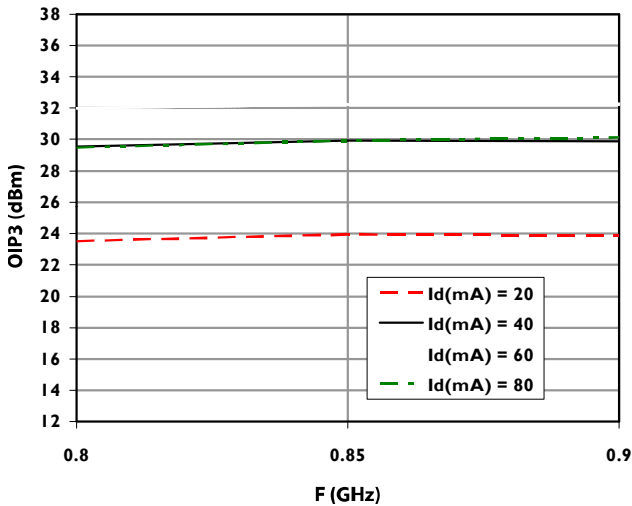

P1dB

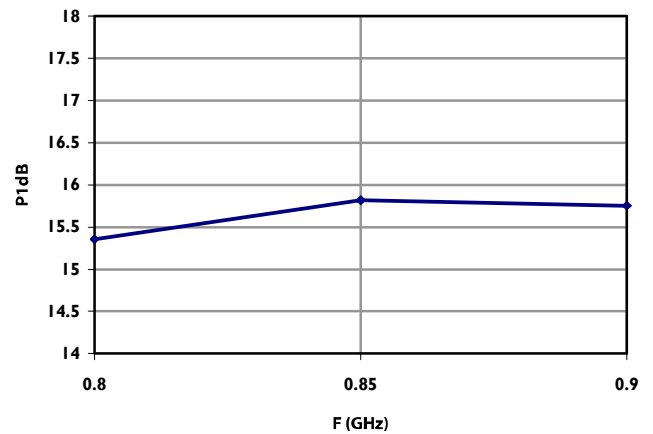

## S-Parameters<sup>7</sup>: 4 V

Reverse Isolation

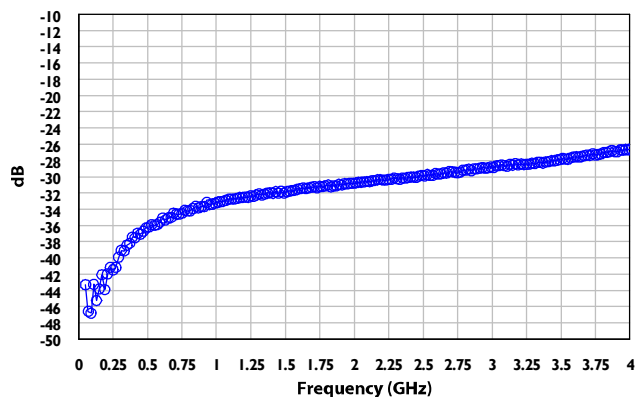

Gain

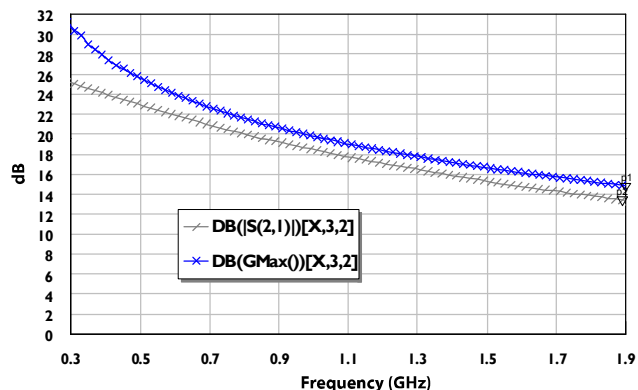

Output Return Loss

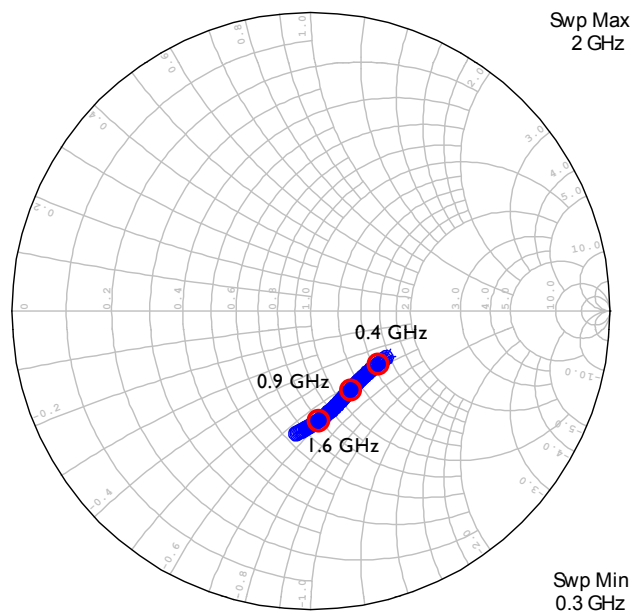

Input Return Loss

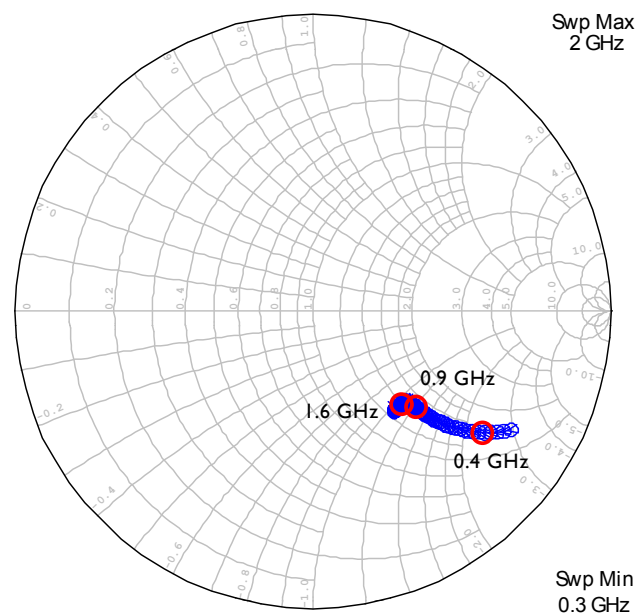

7. S-Parameters files are available for download at [macomtech.com](http://macomtech.com).

## Evaluation Board

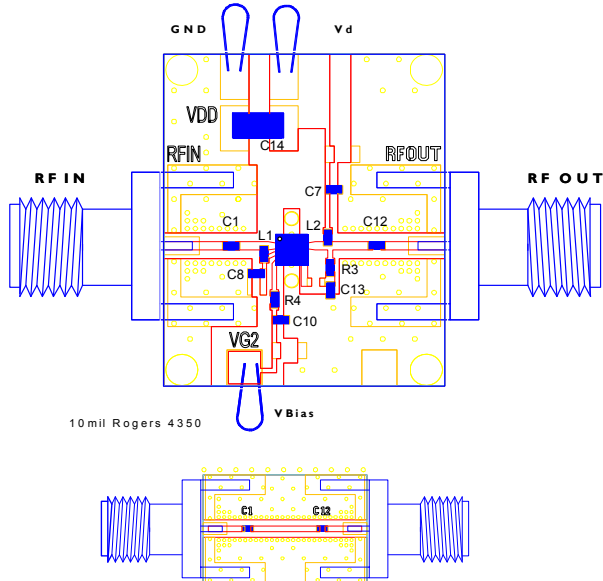

The above thru line can be provided to de-embed the losses of the evaluation board.

## Off-Chip Component Values

Component	Value	Package
C1	3.3 pF	0402
C7, C8, C10	1000 pF	0402
C12, C13	100 pF	0402
C14	100 $\mu$ F	Tantalum, Size D
L1	9 nH	0402
L2	15 nH	0402
R3	150 $\Omega$	0402
R4	240 $\Omega$	0402

## Schematic

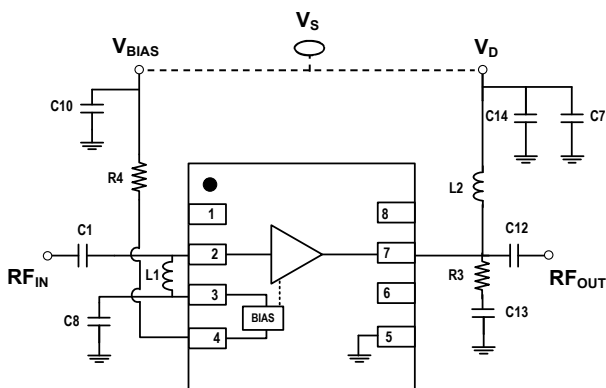

$V_{BIAS}$  and  $V_D$  are separate connections on the evaluation board to give the option of varying  $I_d$  without changing  $R_4$ . They can be connected together to a single voltage supply during the measurement and in the final layout implementation of the PCB. If two different voltage supplies are used then apply  $V_D$  first and then  $V_{BIAS}$  to turn on the LNA. To turn off the LNA disconnect  $V_{BIAS}$  first and then  $V_D$ .  $R_3$  is varied to obtain different levels of gain.  $R_4$  is varied to change the drain current  $I_d$ .

## Optional Schematic

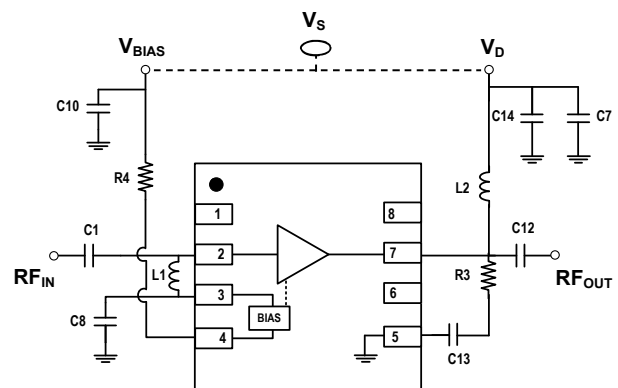

Optional schematic illustrates alternate grounding choice for  $C_{13}$  through pin 5. Pin 5 is grounded internally in the package. Electrical performance of both layout methods is identical.



### Lead-Free 2 mm 8-Lead PDFN<sup>†</sup>

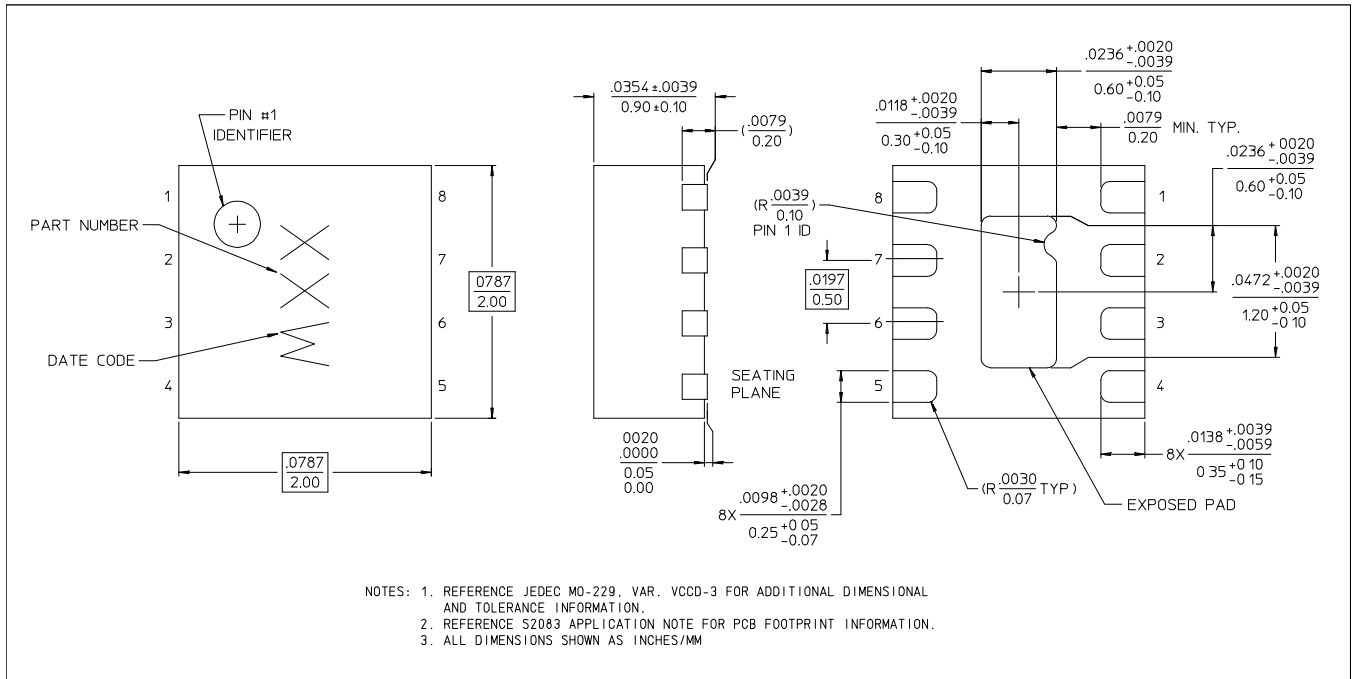

<sup>†</sup> Reference Application Note S2083 for lead-free solder reflow recommendations.  
Meets JEDEC moisture sensitivity level 1 requirements.