

Driver Amplifier 27.5 - 33.4 GHz

Rev. V3

Features

- 3 Stage Driver Amplifier for 28/32 GHz Bands
- 21 dB Gain
- 32 dBm Output Third Order Intercept (OIP3)
- 20 dBm Output P1dB
- Variable Gain with Adjustable Bias
- Lead-Free 4 mm 24 Lead PQFN Package
- RoHS* Compliant and 260°C Reflow Compatible

Description

The MAAM-011139 is a driver amplifier assembled in a lead-free 4 mm 24-lead PQFN plastic package that operates from 27.5 - 33.4 GHz.

The amplifier provides 21 dB small signal gain. The input and output are internally matched to 50 ohms with on-chip DC blocking capacitors. The 32 dBm Output Third Order Intercept Point (OIP3) and 20 dBm output P1dB provide excellent linearity for transmit lineups.

Each device is 100% RF tested to ensure performance compliance.

Ordering Information^{1,2}

Part Number	Package
MAAM-011139-TR0500	500 piece reel
MAAM-011139-TR1000	1000 piece reel
MAAM-011139-000SMB	Sample Board

1. Reference Application Note M513 for reel size information.
2. All sample boards include 5 loose parts.

Functional Schematic

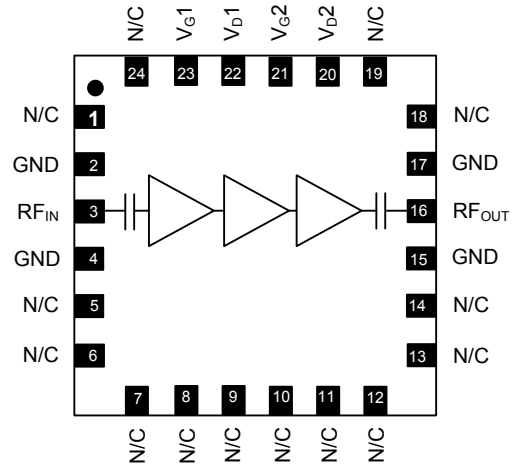

Pin Configuration^{3,4}

Pin No.	Function	Pin No.	Function
1	N/C	13	N/C
2	GND	14	N/C
3	RF _{IN}	15	GND
4	GND	16	RF _{OUT}
5	N/C	17	GND
6	N/C	18	N/C
7	N/C	19	N/C
8	N/C	20	V _D 2
9	N/C	21	V _G 2
10	N/C	22	V _D 1
11	N/C	23	V _G 1
12	N/C	24	N/C

3. MACOM recommends connecting unused package pins to ground.
4. The exposed pad centered on the package bottom must be connected to RF, DC and thermal ground.

* Restrictions on Hazardous Substances, European Union Directive 2011/65/EU.

Electrical Specifications⁵:

Freq = 27.5 - 33.4 GHz, $T_A = 25^\circ\text{C}$, $V_{D1,2} = 4.0\text{ V}$, $I_{D1} = 100\text{ mA}$, $I_{D2} = 100\text{ mA}$

Parameter	Test Conditions	Units	Min.	Typ.	Max.
Gain	27.5 - 29.5 GHz 29.5 - 33.4 GHz	dB	19.0 15.5	21.0 17.5	—
Input Return Loss	—	dB	—	-10	—
Output Return Loss	—	dB	—	-8	—
Output P1dB	—	dBm	—	20	—
Output IP3	27.5 - 29.5 GHz 29.5 - 33.4 GHz	dBm	28 30	32 32	—

5. Apply gate voltages prior to drain voltages. Adjust VG1 and VG2 between -1.0 and -0.1 V to achieve specified current.
Typical current, 200 mA = 100 (I_{D1}) + 100 (I_{D2})

Absolute Maximum Ratings^{6,7}

Parameter	Absolute Maximum
Input Power	+20 dBm
Drain Supply Voltage	+4.3 Volts
Operating Temperature	-40°C to +85°C
Junction Temperature	+150°C
Storage Temperature	-55°C to +150°C

6. Exceeding any one or combination of these limits may cause permanent damage to this device.
7. MACOM does not recommend sustained operation near these survivability limits.

Handling Procedures

Please observe the following precautions to avoid damage:

Static Sensitivity

Gallium Arsenide Integrated Circuits are sensitive to electrostatic discharge (ESD) and can be damaged by static electricity. Proper ESD control techniques should be used when handling these Class 1C devices.

Typical Performance Curves

AvgIIP3, Gain, OIP3 vs Freq. Pin=-12 dBm, Id1,2=100mA

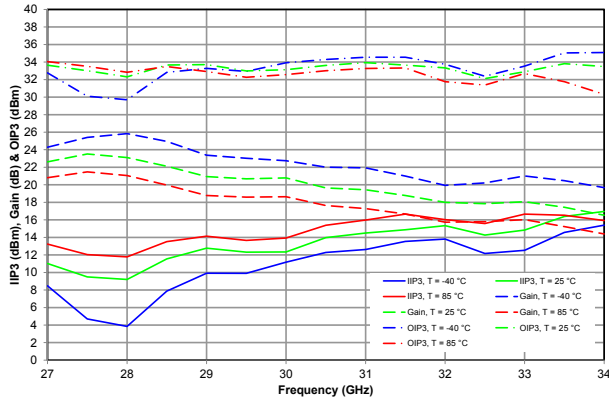

Gain & Linearity vs DC Power at 28 and 32 GHz

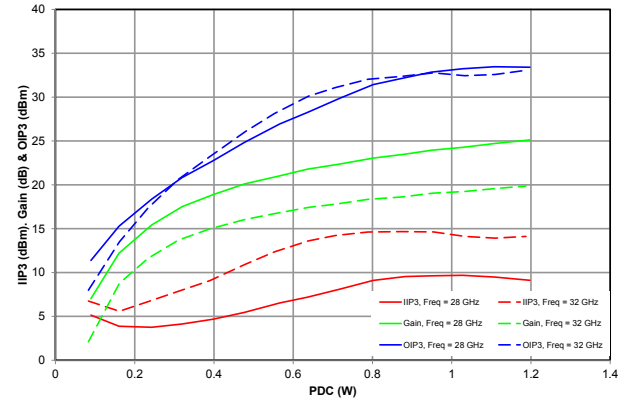

P1dB vs. Frequency VD1,2=4V, Id1,2=100 mA

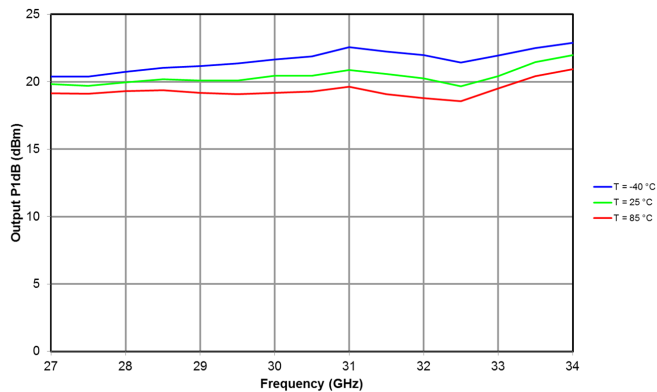

Gain vs. Pin VD1,2=4V, Id1,2=100 mA

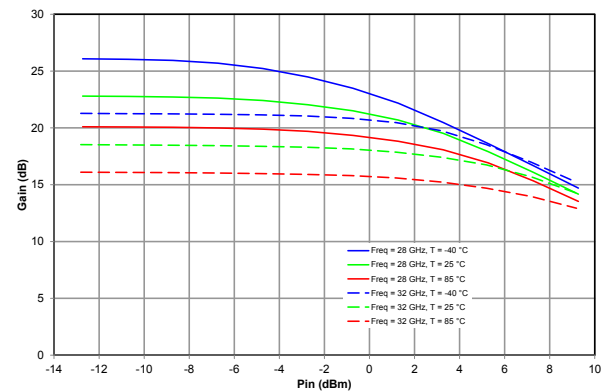

Pout vs. Pin VD1,2=4V, Id1,2=100 mA

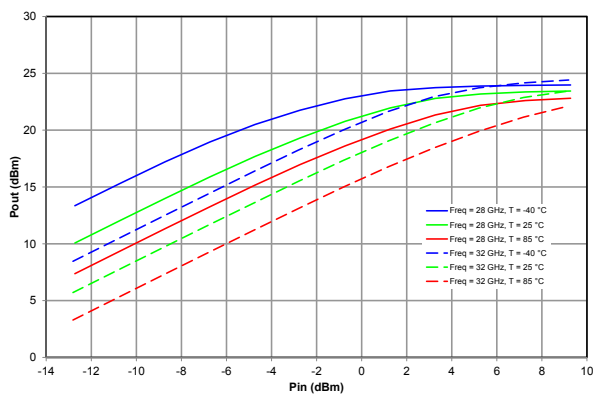

Gain vs. Pout VD1,2=4V, Id1,2=100 mA

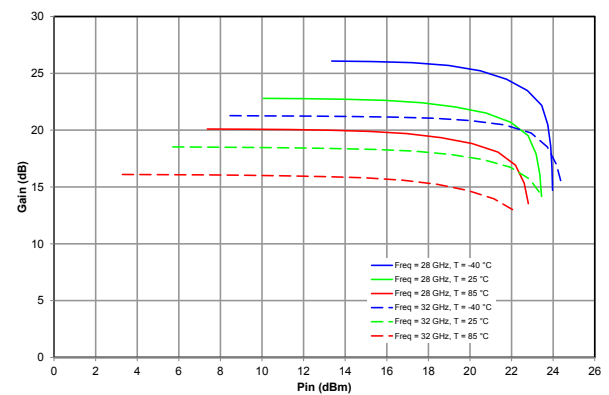

Lead-Free 4 mm 24-Lead PQFN[†]

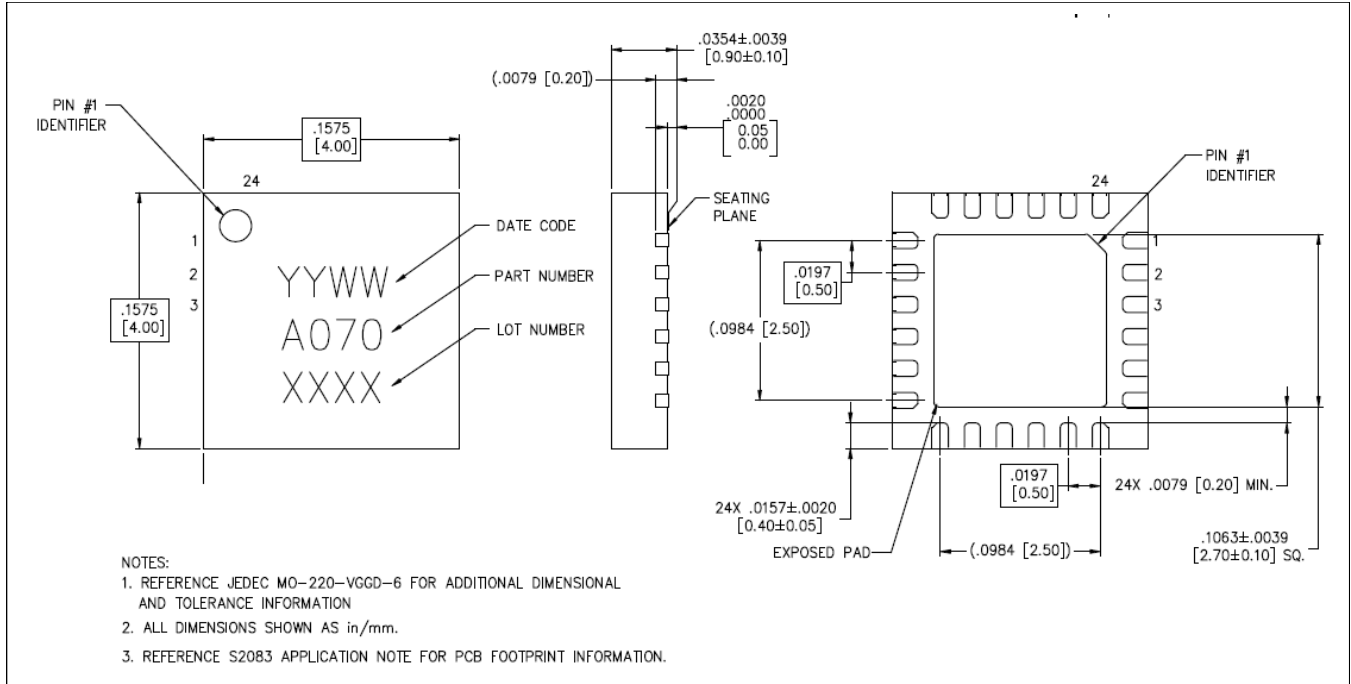

[†] Reference Application Note S2083 for lead-free solder reflow recommendations.
 Meets JEDEC moisture sensitivity level 1 requirements.
 Plating is 100% matte tin over copper.