

## Differential CATV Variable Gain Amplifier 45 - 1218 MHz

Rev. V2

### Features

- 36 dB Gain
- 25 dB Attenuation Range
- 2.5 dB Noise Figure
- -62 dBc ACPR @ 67 dBmV Output  
-1 channel 256 QAM
- -60 dBc ACPR @ 59 dBmV/channel  
-4 channel 256 QAM
- 6 V, 930 mA
- Differential Input and Output
- Low Harmonics
- Single Control Voltage
- Lead-Free 5 x 7 mm PQFN-40LD
- Halogen-Free "Green" Mold Compound
- RoHS\* Compliant

### Description

The MAAM-011194 is an integrated 3 stage differential amplifier with embedded voltage variable attenuator. This part is intended as the output amplifier in a downstream Edge QAM RF modulator to support DOCSIS3.1 applications. The module provides high gain, low noise figure and excellent linearity and ACPR at output levels 7 dB above Cable Labs DRFI requirements. The voltage variable attenuator (VVA) is implemented with PIN diodes to provide continuous power level control with high linearity with a single control voltage. The part is packaged in a 5 x 7 mm PQFN package.

### Ordering Information<sup>1,2</sup>

Part Number	Package
MAAM-011194-TR1000	1000 piece reel
MAAM-011194-1SMB	Sample Test Board

1. Reference Application Note M513 for reel size information.
2. All sample boards include 5 loose parts.

### Functional Schematic

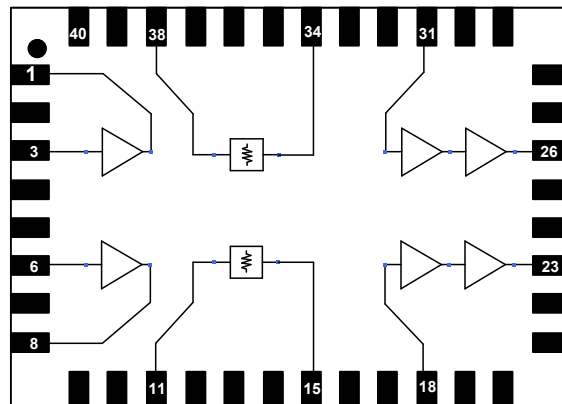

### Pin Configuration<sup>3,4</sup>

Pin No.	Pin Name	Description
1	RF <sub>OUT</sub> 1+	Stage 1 Output (+)
3	RF <sub>IN</sub> 1+	Stage 1 Input (+)
6	RF <sub>IN</sub> 1-	Stage 1 Input (-)
8	RF <sub>OUT</sub> 1-	Stage 1 Output (-)
9,17,32,40	V <sub>REF</sub>	VVA reference voltage
11	VVA <sub>IN</sub> -	VVA Input (-)
13,36	V <sub>CNTL</sub>	VVA Control Voltage
15	VVA <sub>OUT</sub> -	VVA Output (-)
18	RF <sub>IN</sub> 2-	Stage 2 Input (-)
19	FB2-	Stage 2 Feedback (-)
20	V <sub>DD</sub> 2-	Stage 2 Drain Bias (-)
23	RF <sub>OUT</sub> -	Output of VGA (-)
24	IADJ2	Stage 2 Current Adjust
25	IADJ3	Stage 3 Current Adjust
26	RF <sub>OUT</sub> +	Output of VGA (+)
29	V <sub>DD</sub> 2+	Stage 2 Drain Bias (+)
30	FB2+	Stage 2 Feedback (+)
31	RF <sub>IN</sub> 2+	Stage 2 Input (+)
34	VVA <sub>OUT</sub> +	VVA Output (+)
38	VVA <sub>IN</sub> +	VVA Input (+)
41	Paddle	RF & DC Ground

3. Do not ground pins 10,12,14,16, 33, 35, 37 and 39 (all are "No Connection").
4. Pins 2, 4, 5, 7, 21, 22, 27 and 28 may or may not be grounded (all are "No Connection").

\* Restrictions on Hazardous Substances, European Union Directive 2011/65/EU.

## Differential CATV Variable Gain Amplifier 45 - 1218 MHz

Rev. V2

**Electrical Specifications<sup>5</sup>:  $T_A = 25^\circ\text{C}$ ,  $V_{DD} = +6\text{ Volts}$ ,  $V_{REF} = 1.8\text{ Volts}$ ,  $Z_0 = 75\ \Omega$ ,  
(Performance specified with input/output Balun MABA-010321-CT1A42)**

Parameter	Test Conditions	Units	Min.	Typ.	Max.
Gain	$V_{CNTL} = 5.5\text{ V}$ , 1218 MHz	dB	34	36	—
Gain Slope	45 - 1218 MHz	dB	—	0.5	—
Noise Figure <sup>6</sup>	45 - 1218 MHz	dB	—	2.5	—
Input Return Loss	45 - 1218 MHz	dB	—	18	—
Output Return Loss	45 - 1218 MHz	dB	—	17	—
Reverse Isolation	45 - 1218 MHz	dB	—	65	—
Attenuation Range	$V_{CNTL} = 5.5 - 1.3\text{V}$ , 45 - 1218 MHz		—	25	—
Maximum Output	Level N = 1 Level N = 4, 981 MHz	dBmV	— 56	67 59	—
ACPR <sup>7</sup>	@ max output N = 1 @ max output N = 4, 981 MHz	dBc	—	—	-62 -60
P1dB	45 - 1218 MHz	dBm	—	28.5	—
OIP2	2-tone, 12 dBm/tone, 6 MHz spacing, 500 MHz	dBm	—	80	—
OIP3	2-tone, 12 dBm/tone, 6 MHz spacing, 500 MHz	dBm	—	48	—
CTB	79 Analog Channels, 40 dBmV per channel output, QAM to 1 GHz	dBc	—	-78	—
CSOL	79 Analog Channels, 40 dBmV per channel output, QAM to 1 GHz	dBc	—	-78	—
CSOH	79 Analog Channels, 40 dBmV per channel output, QAM to 1 GHz	dBc	—	-81	—
2 <sup>nd</sup> Harmonic	Single Channel, $P_{OUT} = 67\text{ dBmV}$	dBc	—	-65	—
3 <sup>rd</sup> Harmonic	Single Channel, $P_{OUT} = 67\text{ dBmV}$	dBc	—	-65	—
$I_{DD}$	$I_{D1} + I_{D2} + I_{D3}$	mA	—	930	1030
$I_{D3}$	—	mA	—	520	580
$I_{CONTROL}$	$V_{CNTL} = 5.5\text{ V}$	mA	—	35	—
$I_{REF}$	$V_{REF} = 1.8$ , $V_{CNTL} = 1.3\text{ V}$	mA	—	8	—

5. N = number of channels

6. Includes Balun Loss.

7. Adjacent Channel (750 kHz from channel block edge to 6 MHz from channel block edge)

### Maximum Operating Condition<sup>8</sup>

Parameter	Maximum Operating Condition
RF Input Power <sup>9</sup>	-6 dBm
Voltage	6 volts
Operating Temperature	-40°C to +100°C
Junction Temperature <sup>10</sup>	+155°C

8. Operating at nominal conditions with  $T_J < 155^\circ\text{C}$  will ensure  $\text{MTTF} > 1 \times 10^6$  hours.
9. Assumes maximum gain state. For each dB of attenuation the maximum RF Input Power may increase by 1 dB up to +7 dBm.
10. Junction Temperature ( $T_J$ ) =  $T_C + \Theta_{JC} * (V * I)$   
 Typical thermal resistance ( $\Theta_{JC}$ ) =  $14.6^\circ\text{C/W}$ .
- a) For  $T_C = 25^\circ\text{C}$ ,  
 $T_J = 71^\circ\text{C}$  @ 6 V, 520 mA (Stage3,  $I_{D3}$ )
- b) For  $T_C = 100^\circ\text{C}$ ,  
 $T_J = 141^\circ\text{C}$  @ 6 V, 470 mA (Stage3,  $I_{D3}$ )

### Printed Circuit Board (PCB) Thermal Design

To maintain reliable junction temperatures for this high power amplifier the printed circuit board must provide low thermal resistance to the exposed paddle of the IC package. This requires both a large array of high thermal conductive vias beneath the IC as well as good heat sinking at the back of side of the PCB. In general, thinner substrates and thicker plating for vias provide lower thermal resistance. For a standard 62 mil board the following copper plating thickness for vias and top and bottom metal layers are recommended.

Vias plated to 2-mil (50  $\mu\text{m}$ ) thickness of copper.  
 Finished via diameter 9.5 mils (0.25 mm).  
 Via spacing 20 mils (0.51 mm).  
 2.8-mil (70  $\mu\text{m}$ ) thick copper for top and bottom metal.

For additional details and support please contact  
<https://www.macom.com/support>

### Absolute Maximum Ratings<sup>11,12,13</sup>

Parameter	Absolute Maximum
RF Input Power <sup>11</sup>	-3 dBm
Voltage	9 volts
Storage Temperature	-65°C to +150°C

11. Assumes maximum gain state, for each dB of attenuation the maximum RF input power may increase by 1 dB up to +10 dBm.
12. Exceeding any one or combination of these limits may cause permanent damage to this device.
13. MACOM does not recommend sustained operation near these survivability limits.

### Handling Procedures

Please observe the following precautions to avoid damage:

### Static Sensitivity

Integrated Circuits are sensitive to electrostatic discharge (ESD) and can be damaged by static electricity. Proper ESD control techniques should be used when handling these devices.

## Differential CATV Variable Gain Amplifier 45 - 1218 MHz

Rev. V2

### Recommended PCB

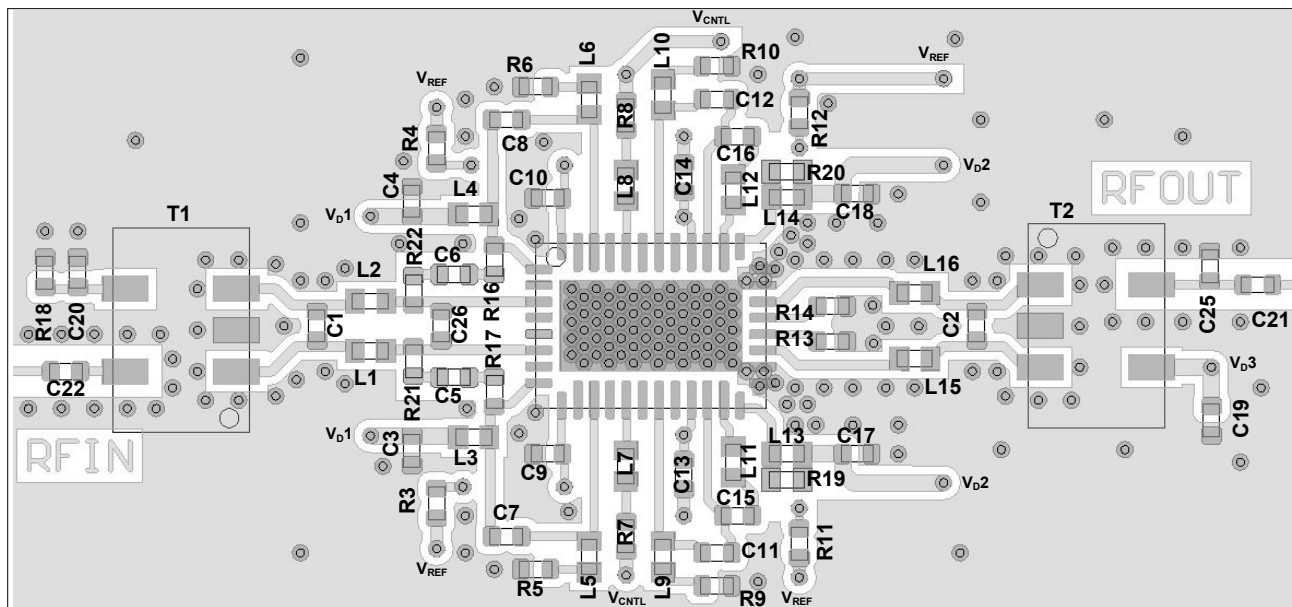

### Parts List

Component	Value	Package
C26	1.2 pF	0402
C2	1.8 pF	0402
C3, C4, C9, C10, C13, C14, C17 - C22	0.01 $\mu$ F	0402
C5, C6, C11, C12, C15, C16	1000 pF	0402
C7, C8	180 pF	0402
C25	0.5 pF	0402
L1, L2	1.2 nH	0402
L3 - L8, L13 - L14 <sup>14</sup>	1 k $\Omega$	0402
L9, L10	100 nH	0402
L11, L12	13 nH	0402
L15, L16	0 $\Omega$	0402
R3 - R6, R9 - R12	200 $\Omega$	0402
R7, R8, R13	150 $\Omega$	0402
R14	82 $\Omega$	0402
R16, R17, R21, R22	240 $\Omega$	0402
R18	8 k $\Omega$	0402
R19, R20	360 $\Omega$	0402
T1, T2	1:1 Baluns (MACOM part # MABA-010321-CT1A42)	
C1	Do Not Install	

4 14. The 1 k $\Omega$  ferrite bead (part number BLM15HD102SN) is from Murata.

MACOM Technology Solutions Inc. (MACOM) and its affiliates reserve the right to make changes to the product(s) or information contained herein without notice. Visit [www.macom.com](http://www.macom.com) for additional data sheets and product information.

## Differential CATV Variable Gain Amplifier 45 - 1218 MHz

Rev. V2

### Application Schematic

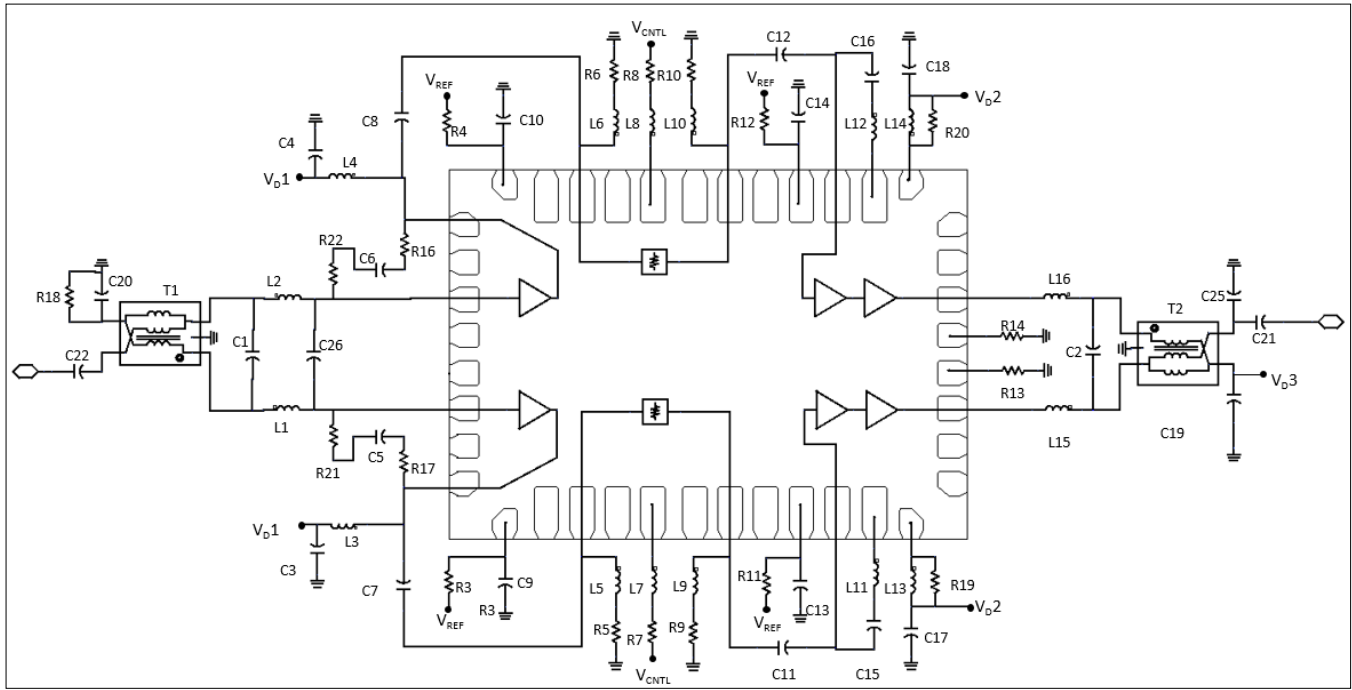

### Land Pattern<sup>15</sup>

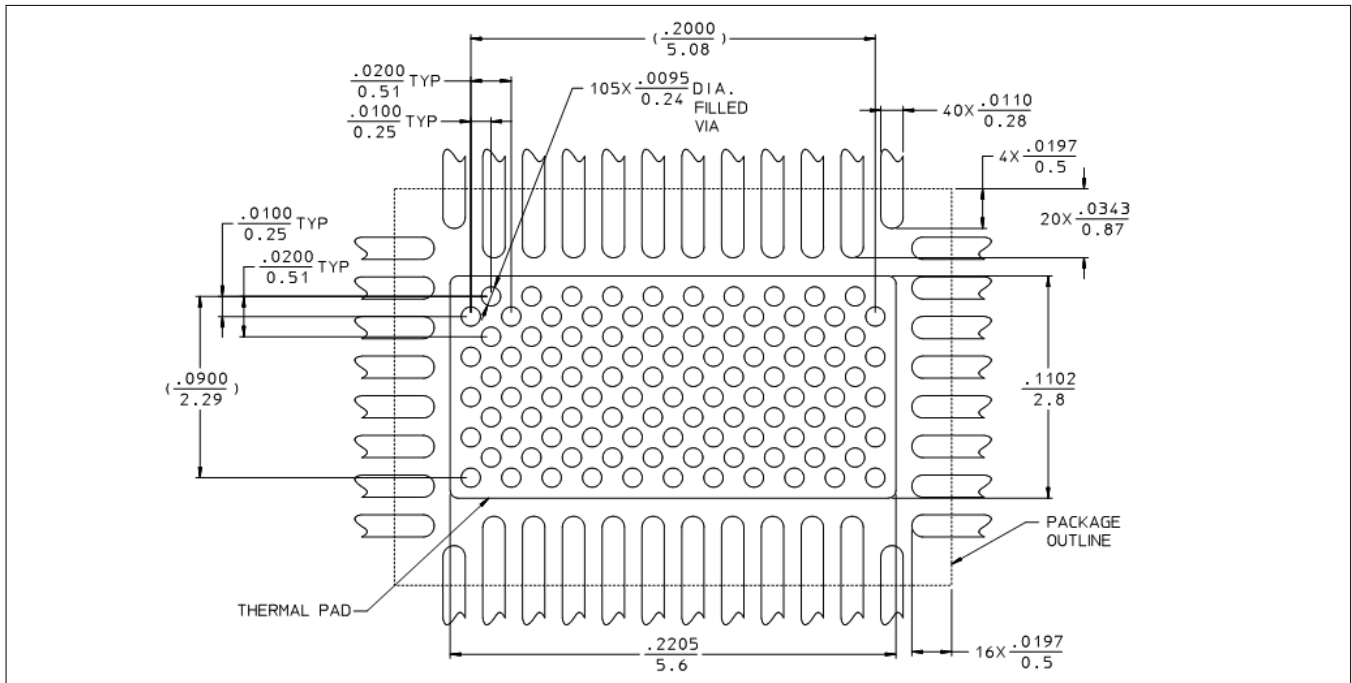

15. Vias to be plated to 2 mil thickness of copper.

## Differential CATV Variable Gain Amplifier 45 - 1218 MHz

Rev. V2

Typical Performance Curves:  $V_{DD} = 6\text{ V}$ ,  $V_{REF} = 1.8\text{ V}$

**Gain vs. Frequency & VVA Control Voltage, 25°C**

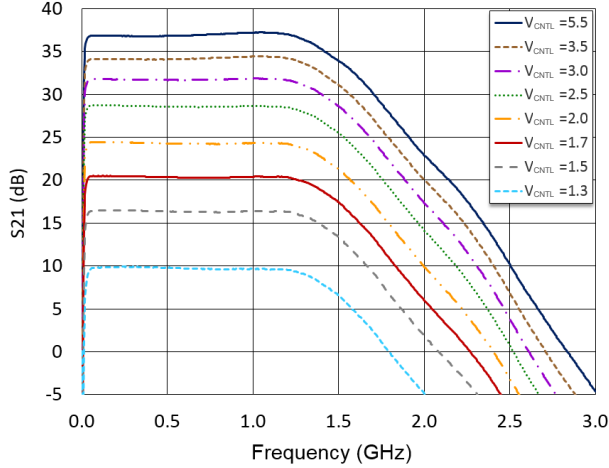

**Gain vs. Frequency & Temperature, Max Gain State**

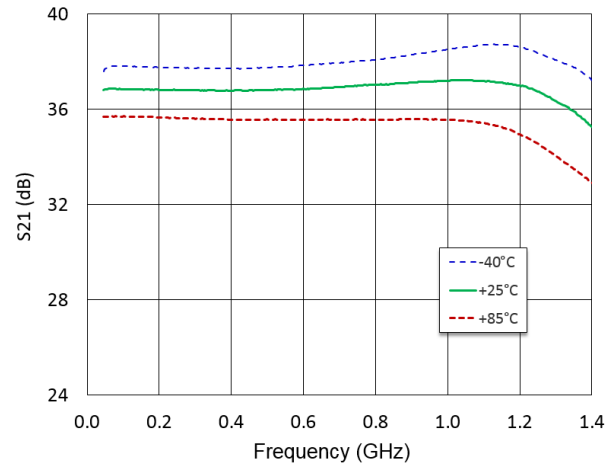

**S11 vs. Frequency & VVA Control Voltage, 25°C**

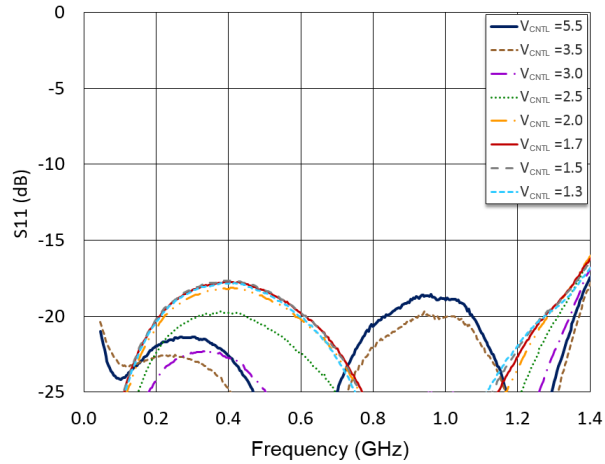

**S11 vs. Frequency & Temperature, Max Gain State**

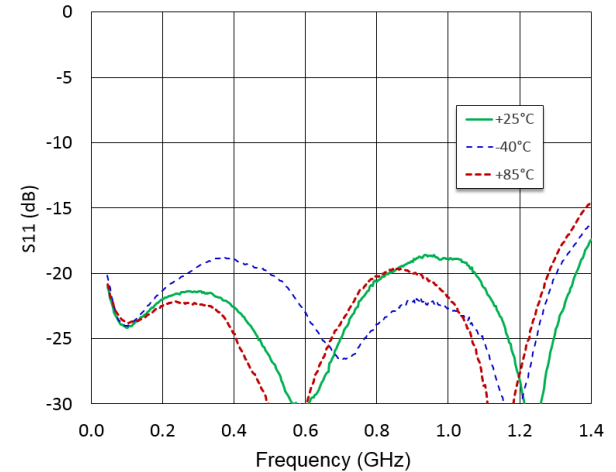

**S22 vs. Frequency & VVA Control Voltage, 25°C**

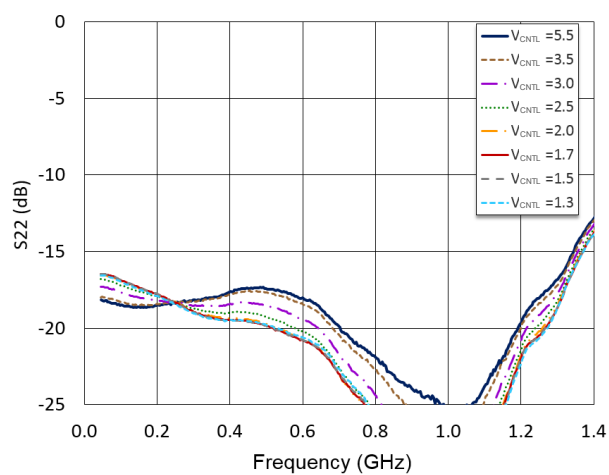

**S22 vs. Frequency & Temperature, Max Gain State**

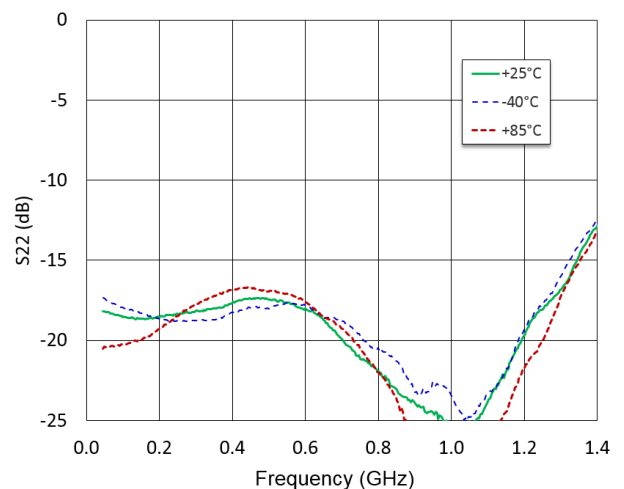

## Differential CATV Variable Gain Amplifier 45 - 1218 MHz

Rev. V2

Typical Performance Curves:  $V_{DD} = 6\text{ V}$ ,  $V_{REF} = 1.8\text{ V}$

**Gain vs. VVA Control Voltage & Temperature, 500 MHz**

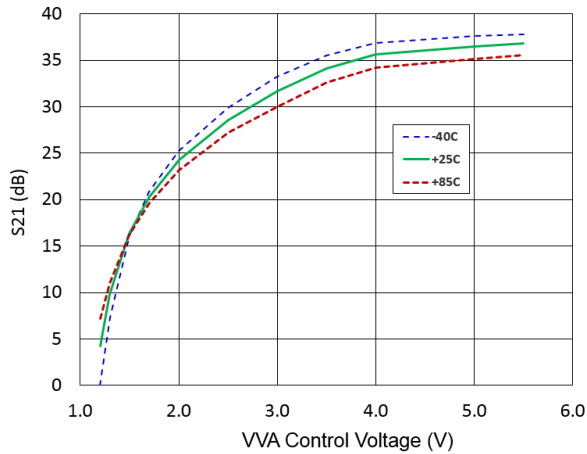

**Noise Figure vs. Frequency,  $V_{CNTL} = 5.5\text{ V}$**

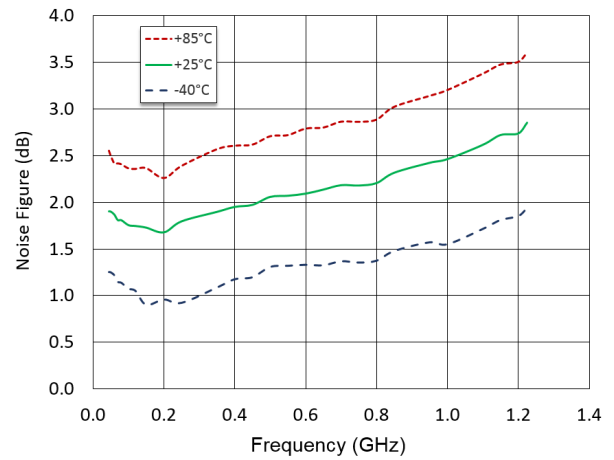

**Reverse Isolation vs. Frequency &  $V_{CNTL}$ , 25°C**

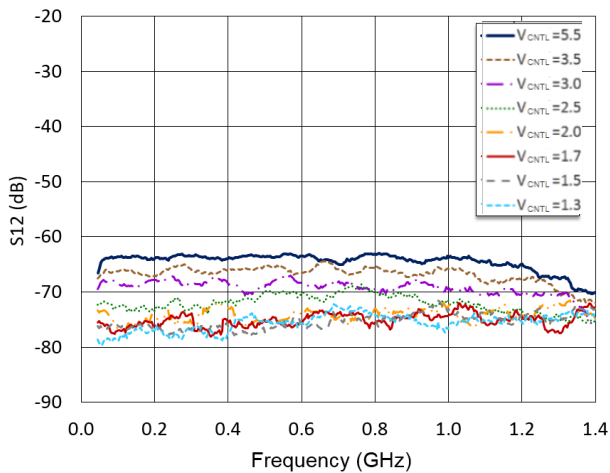

**ACPR vs. Output Power, 4 Channels, 25°C**

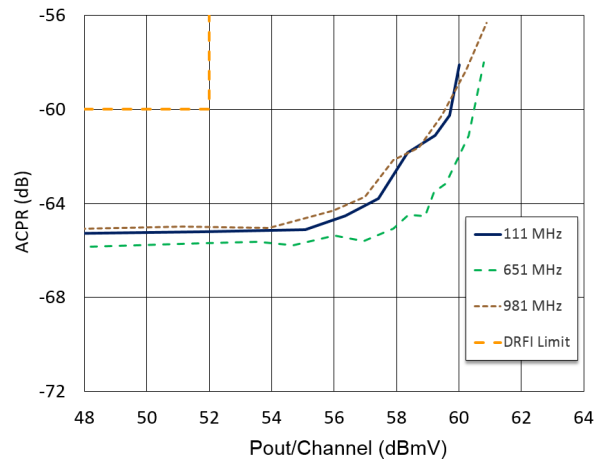

**OIP3,  $P_{OUT} = +12\text{ dBm/tone}$**

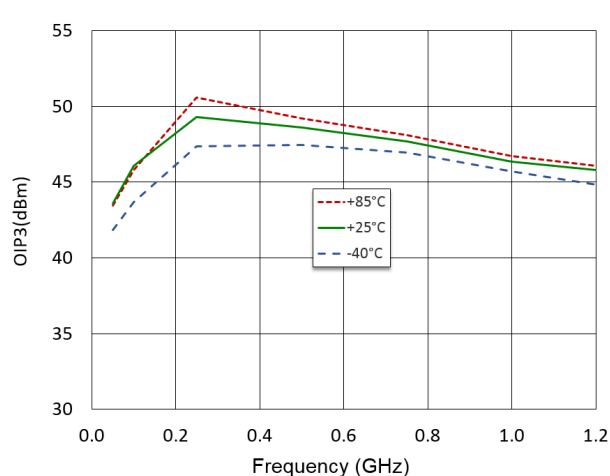

**OIP2,  $P_{OUT} = +12\text{ dBm/tone}$**

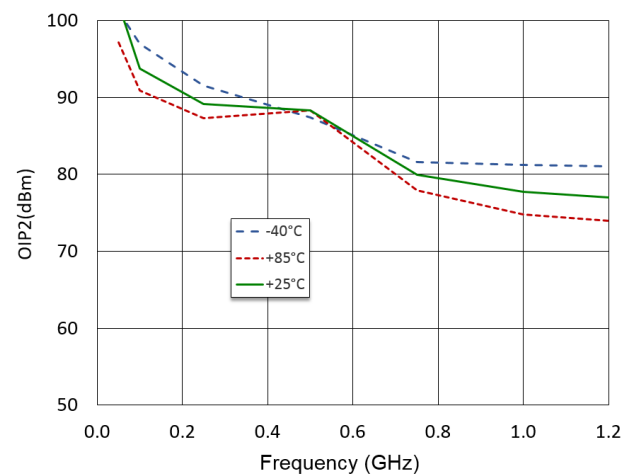

## Differential CATV Variable Gain Amplifier 45 - 1218 MHz

Rev. V2

### Typical Performance Curves: $V_{DD} = 6\text{ V}$ , $V_{REF} = 1.8\text{ V}$

**CSO Lower, 79 channels + QAM to 1 GHz,**  
0 dB tilt, 40 dBmV per channel, 25°C

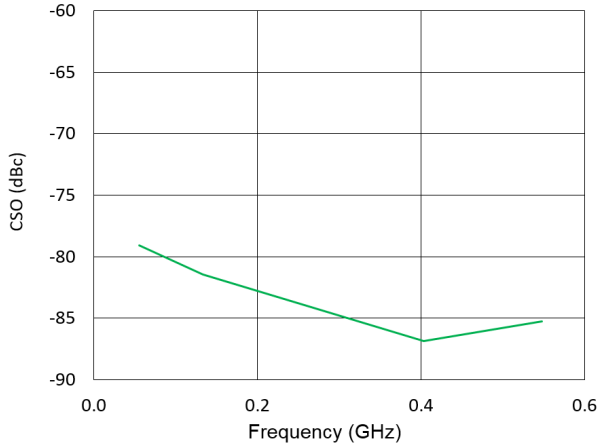

**CSO Upper, 79 channels + QAM to 1 GHz,**  
0 dB tilt, 39 dBmV per channel, 25°C

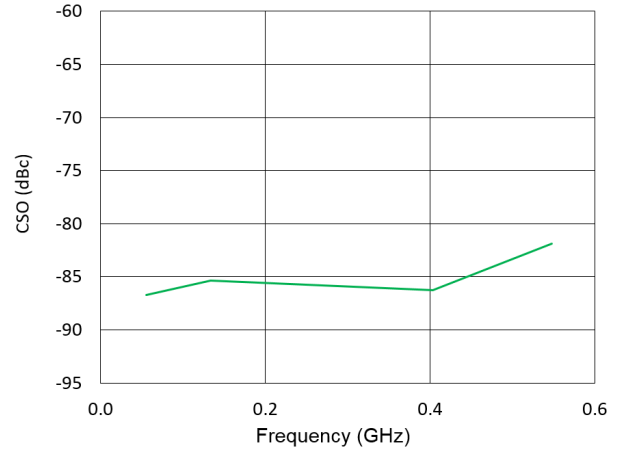

**CTB, 79 channels + QAM to 1 GHz,**  
0 dB tilt, 40 dBmV per channel, 25°C

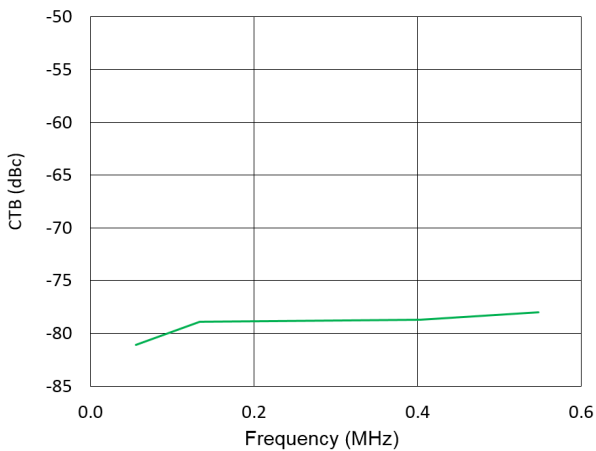

**P1dB**

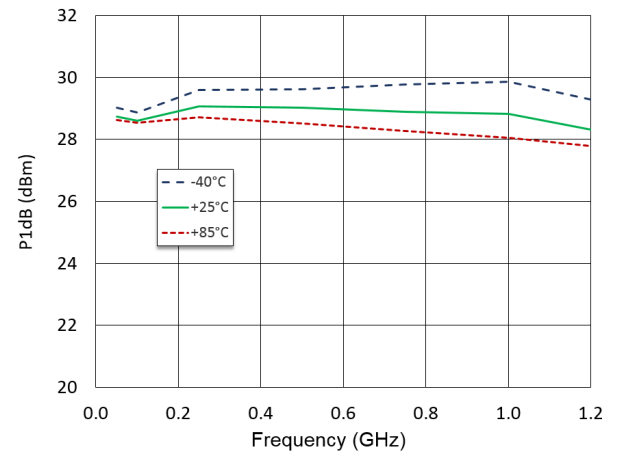

### VGA Control & Reference Current vs. $V_{CNTL}$

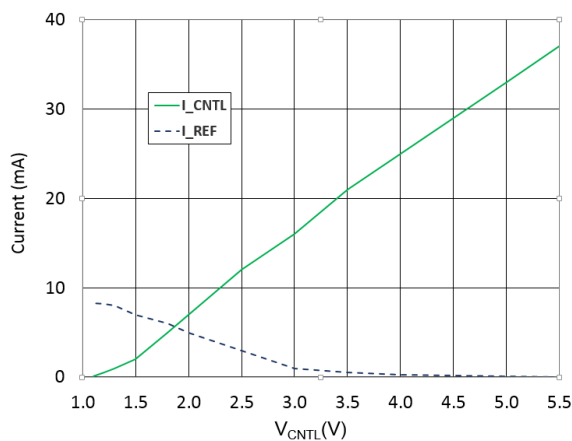



## Differential CATV Variable Gain Amplifier 45 - 1218 MHz

Rev. V2

### Lead-Free 5 x 7 mm 40-Lead PQFN<sup>†</sup>

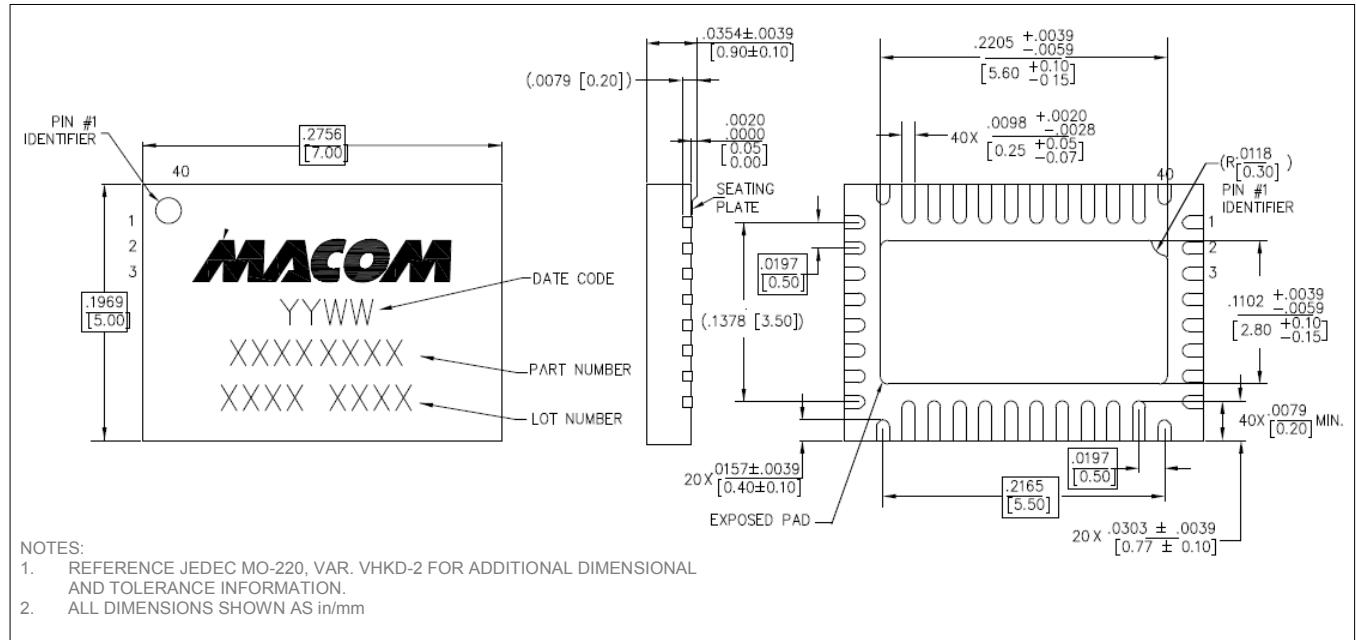

<sup>†</sup> Reference Application Note S2083 for lead-free solder reflow recommendations.  
Meets JEDEC moisture sensitivity level 1 requirements.  
Plating is NiPdAuAg.