

75 Ω , High Linearity, Low Noise, CATV Amplifier 45 - 1800 MHz



MAAM-011300

Rev. V1

Features

- Single Stage, Single Ended
- 5 V, 118 mA or 8 V, 130 mA Operation
- 17.5 dB Flat Gain
- Low Noise
- Low Distortion Performance
- Lead-Free SOT-89 Plastic Package
- RoHS* Compliant

Applications

- 75 Ω Infrastructure

Description

The MAAM-011300 is an RF amplifier assembled in a SOT-89 plastic package. This amplifier provides 17.5 dB of ultra flat gain while biased at either 5 or 8 volts. The amplifier provides excellent linearity.

The MAAM-011300 provides high gain, low noise and low distortion making it ideally suited for 75 Ω infrastructure applications.

Functional Schematic

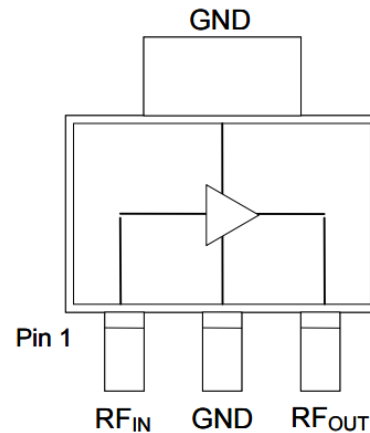

Pin Configuration

Pin #	Pin Name	Function
1	RF _{IN}	RF Input
2	GND	Ground
3	RF _{OUT}	RF Output / Drain Supply

Ordering Information^{1,2}

Part Number	Package
MAAM-011300	Bulk
MAAM-011300-TR1000	1000 piece reel
MAAM-011300-TR3000	3000 piece reel
MAAM-011300-001SMB	sample board

1. Reference Application Note M513 for reel size information.
2. All production sample boards include 5 loose parts.

* Restrictions on Hazardous Substances, compliant to current RoHS EU directive.

75 Ω , High Linearity, Low Noise, CATV Amplifier 45 - 1800 MHz



MAAM-011300

Rev. V1

Electrical Specifications: Freq. = 45 - 1800 MHz, $T_A = 25^\circ\text{C}$, $V_{DD} = 5\text{ V}$, $Z_0 = 75\ \Omega$

Parameter	Test Conditions	Units	Min.	Typ.	Max.
Gain	50 MHz 1218 MHz 1800 MHz	dB	16.6 16.6 16.6	17.6 17.5 17.6	18.6 18.6 18.7
Tilt	45 - 1800 MHz	dB	—	0.4	—
Reverse Isolation	—	dB	—	22	—
Input Return Loss	—	dB	—	20	—
Output Return Loss	—	dB	—	18	—
Noise Figure	50 MHz 1218 MHz 1800 MHz	dB	—	1.7 2.3 3.3	2.7 3.0 4.0
Output IP2	45 - 1800 MHz, tone spacing 6 MHz, P_{OUT} per tone = 5 dBm	dBm	—	54	—
Output IP3	45 - 1800 MHz, tone spacing 6 MHz, P_{OUT} per tone = 5 dBm	dBm	—	34	—
P1dB	—	dBm	—	18	—
Composite Triple Beat, CTB	79 channels, 0 dB Tilt, 34 dBmV per channel output, QAM to 1000 MHz 132 channels, 15 dBmV per channel input	dBc	—	-72 -70	—
Composite Second Order, CSO	79 channels, 0 dB Tilt, 34 dBmV per channel output, QAM to 1000 MHz 132 channels, 15 dBmV per channel input	dBc	—	-66 -66	—
I_{DD}	$V_{DD} = 5\text{ V}$	mA	—	118	135

Maximum Operating Ratings

Parameter	Absolute Maximum
Input Power	11 dBm
V _{DD}	10 V
I _{DD}	200 mA
Operating Temperature	-40°C to +85°C
Storage Temperature ^{5,6}	150°C

3. Exceeding any one or combination of these limits may cause permanent damage to this device.
4. MACOM does not recommend sustained operation near these survivability limits.
5. Operating at nominal conditions with T_J < 150°C will ensure MTTF > 1 x 10⁶ hours.
6. Junction Temperature (T_J) = Case Temperature (T_C) + $\Theta_{JC} \cdot (V \cdot I)$
Typical thermal resistance (Θ_{JC}) = 33°C/W.
 - a) For T_C = 25°C,
T_J = 45°C @ 5 V, 118 mA
 - b) For T_C = 85°C,
T_J = 105°C @ 5 V, 118 mA

Absolute Maximum Ratings^{3,4}

Parameter	Absolute Maximum
RF Input Power CW	25 dBm
V _{DD}	12 V
Storage Temperature	-55°C to +150°C

Handling Procedures

Please observe the following precautions to avoid damage:

Static Sensitivity

Integrated Circuits are sensitive to electrostatic discharge (ESD) and can be damaged by static electricity. Proper ESD control techniques should be used when handling these HBM Class 1B devices.

Recommended PCB Layout

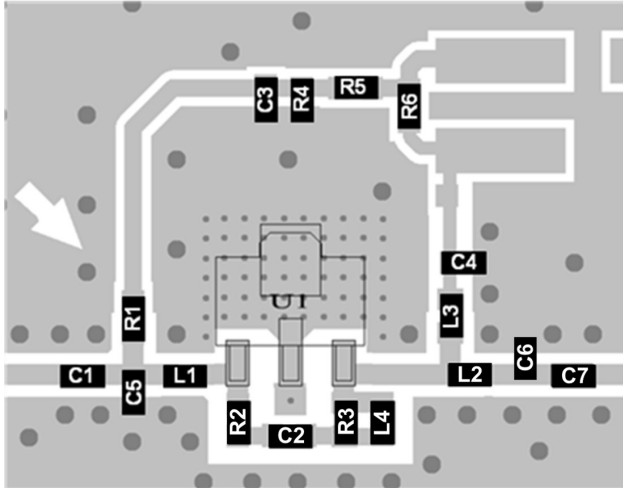

Parts List

Component	Value	Package
C1-C4	10 nF	0402
C5	0.7 pF	0402
C6	0.9 pF	0402
C7	150 pF	0402
L1	7.5 nH	0402
L2	6.8 nH	0402
L3	Ferrite Bead ⁷	0402
L4	24 nH	0402
R1	8 k Ω	0402
R2	590 Ω	0402
R3	160 Ω	0402
R4	330 Ω	0402
R5	10 k Ω	0402
R6	0 Ω	0402

Schematic Including Off-Chip Components

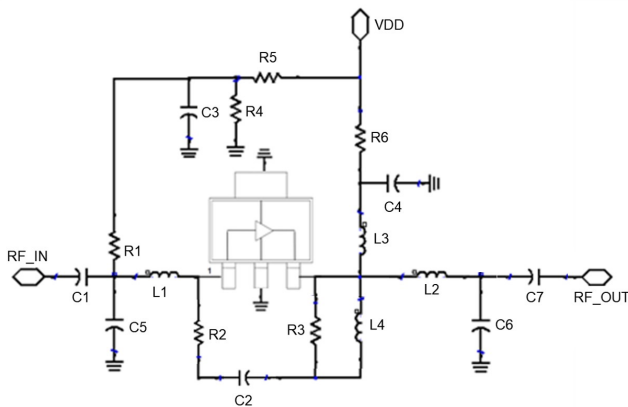

7. Ferrite Bead from Murata, part number BLM15HD182SN.

PCB Land Pattern

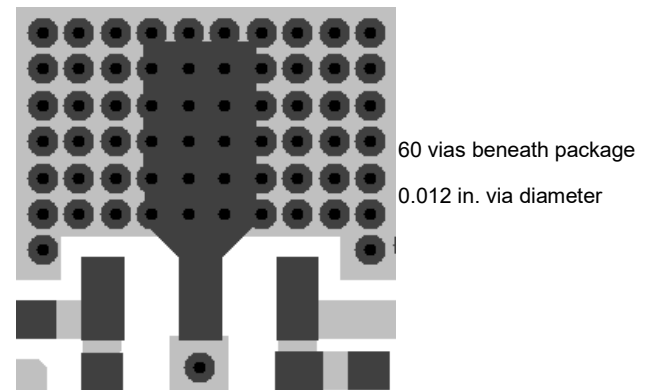

Typical Performance Curves: $V_{DD} = 5\text{ V}$

Gain

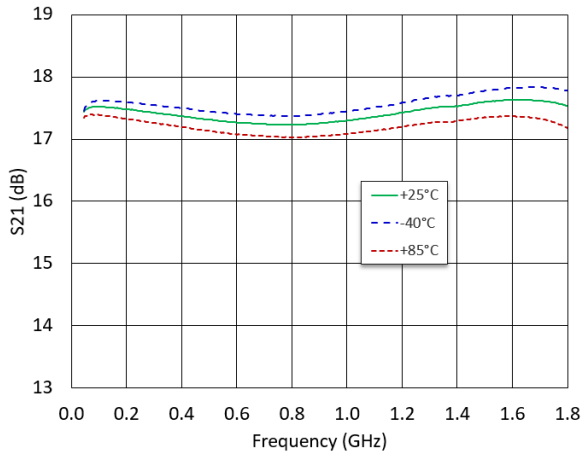

Gain to 3 GHz

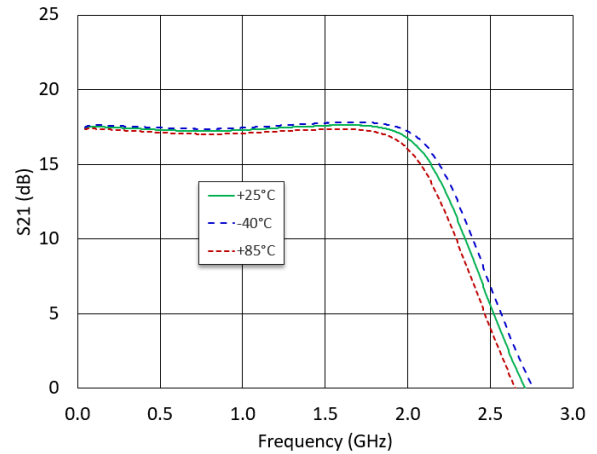

Input Return Loss

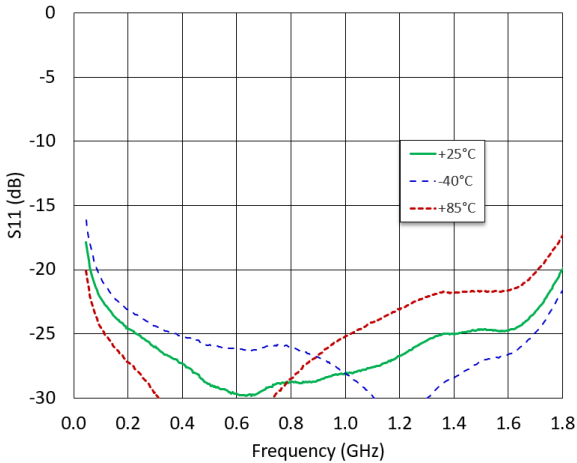

Output Return Loss

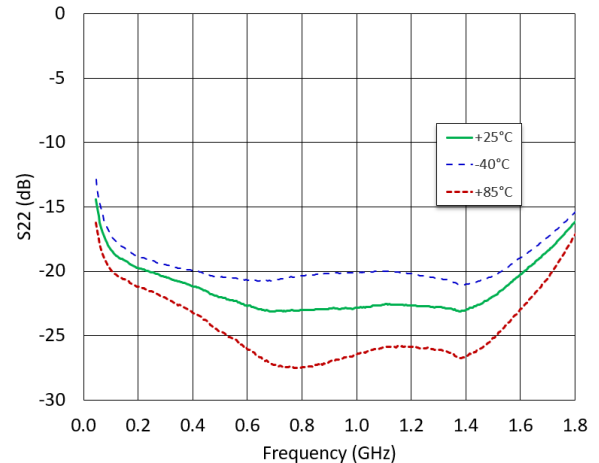

Reverse Isolation

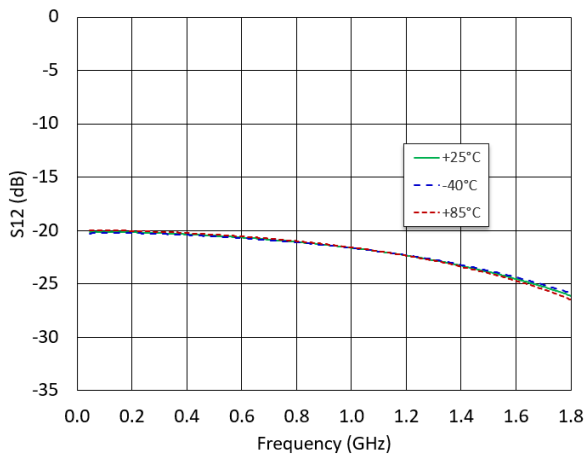

Noise Figure

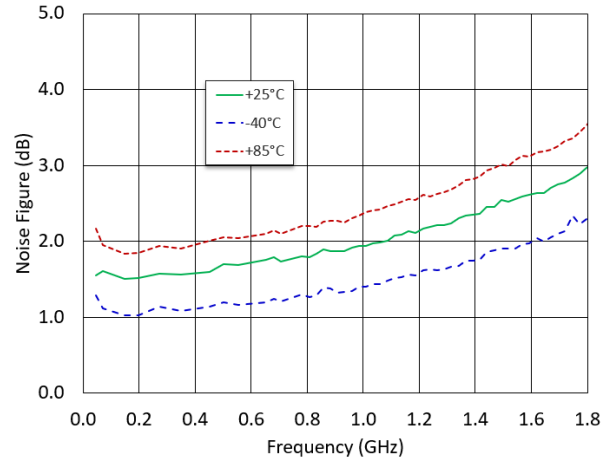

Typical Performance Curves: $V_{DD} = 5\text{ V}$

CSO Lower

79 analog ch + QAM, 0 dB tilt, $P_{OUT} = 34\text{ dBmV per ch}$

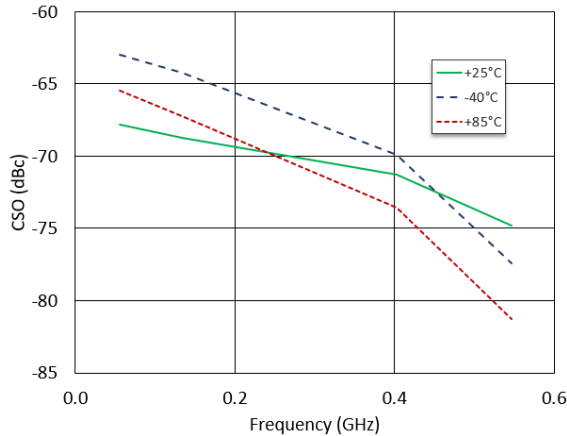

CSO Upper

79 analog ch + QAM, 0 dB tilt, $P_{OUT} = 34\text{ dBmV per ch}$

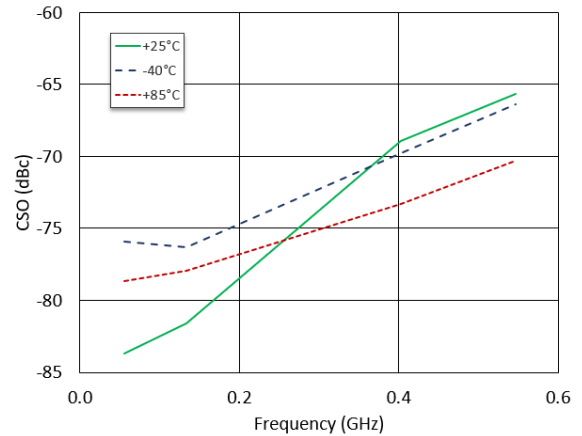

CTB

79 analog ch + QAM, 0 dB tilt, $P_{OUT} = 34\text{ dBmV per ch}$

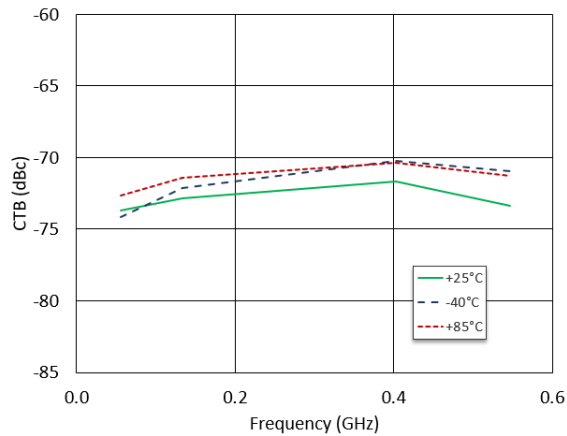

CTB

132 analog ch + QAM, 0 dB tilt, $P_{IN} = 15\text{ dBmV per ch}$

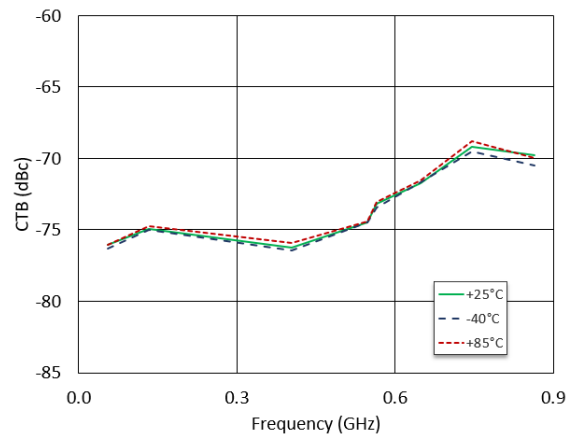

CSO Lower

132 analog ch + QAM, 0 dB tilt, $P_{IN} = 15\text{ dBmV per ch}$

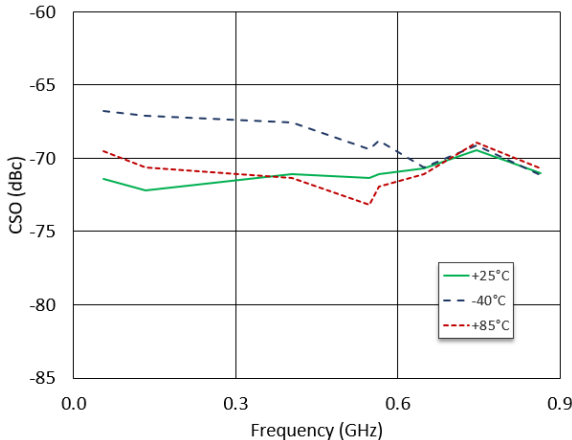

CSO Upper

132 analog ch + QAM, 0 dB tilt, $P_{IN} = 15\text{ dBmV per ch}$

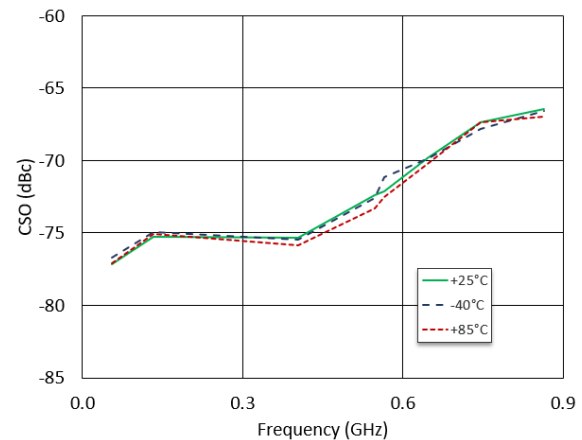

Typical Performance Curves: $V_{DD} = 5\text{ V}$

OIP3, $P_{OUT} = +5\text{ dBm/tone}$

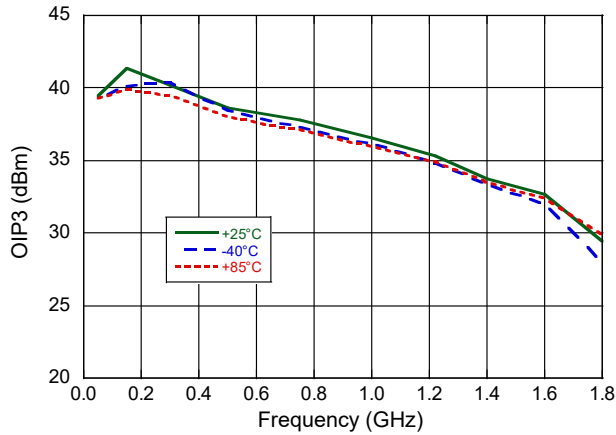

OIP2, $P_{OUT} = +5\text{ dBm/tone}$

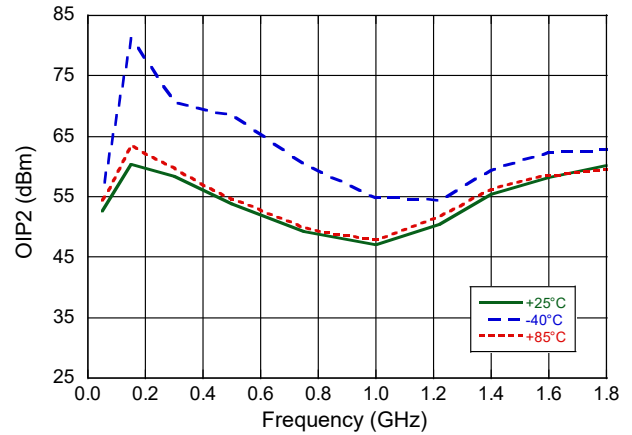

P1dB

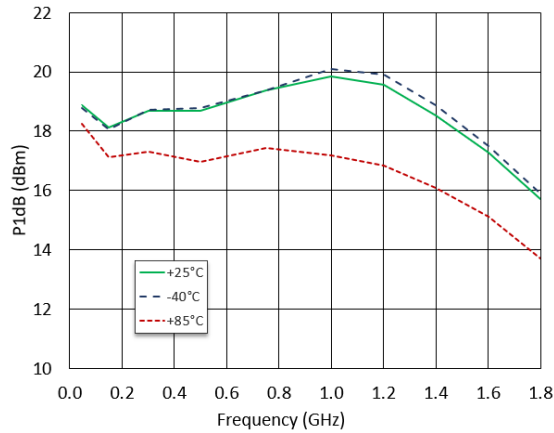

Application Section: $V_{DD} = 8\text{ V}$

The MAAM-011300 can also be operated at $V_{DD} = 8\text{ V}$ using alternate external biasing components.

Recommended PCB Layout

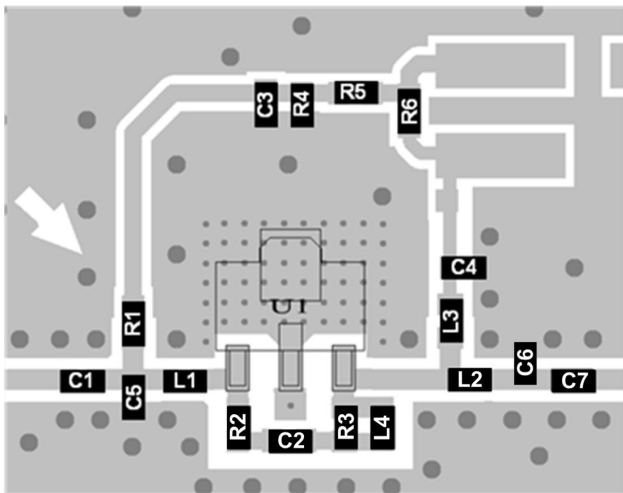

Parts List

Component	Value	Package
C1-C4	10 nF	0402
C5	0.7 pF	0402
C6	0.9 pF	0402
C7	150 pF	0402
L1	7.5 nH	0402
L2	6.8 nH	0402
L3	Ferrite Bead ⁸	0402
L4	24 nH	0402
R1	8 k Ω	0402
R2	590 Ω	0402
R3	160 Ω	0402
R4	300 Ω	0402
R5	10 k Ω	0402
R6	0 Ω	0402

Schematic Including Off-Chip Components

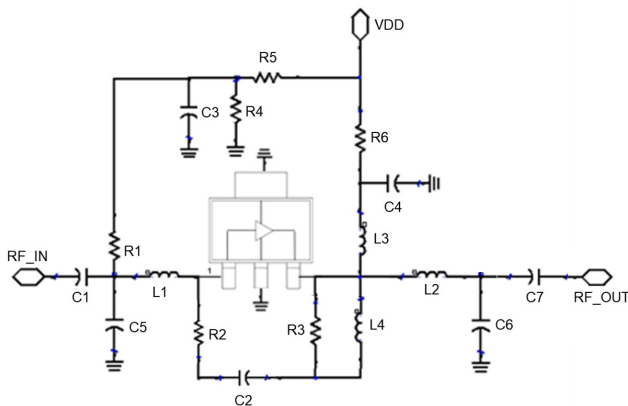

8. Ferrite Bead from Murata, part number BLM15HD182SN.

PCB Land Pattern

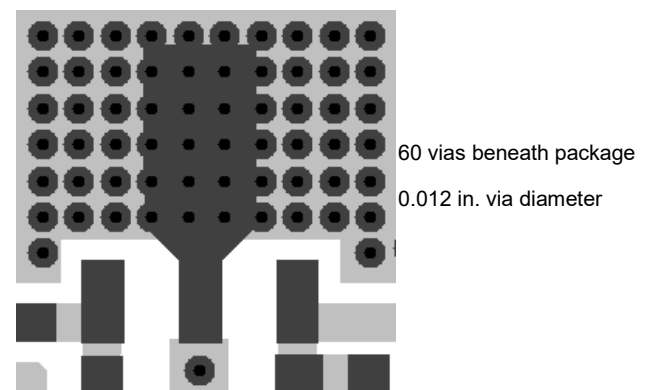

75 Ω , High Linearity, Low Noise, CATV Amplifier 45 - 1800 MHz



MAAM-011300

Rev. V1

Application Section: $V_{DD} = 8\text{ V}$

Electrical Specifications: Freq. = 45 - 1800 MHz, $T_A = 25^\circ\text{C}$, $V_{DD} = 8\text{ V}$, $Z_0 = 75\ \Omega$

Parameter	Test Conditions	Units	Min.	Typ.	Max.
Gain	1800 MHz	dB	—	17.5	—
Tilt	45 - 1800 MHz	dB	—	0.4	—
Reverse Isolation	—	dB	—	22	—
Input Return Loss	—	dB	—	20	—
Output Return Loss	—	dB	—	18	—
Noise Figure	50 - 100 MHz 100 - 1800 MHz	dB	—	1.7 3.2	—
Output IP2	45 - 1800 MHz, tone spacing 6 MHz, P_{OUT} per tone = 5 dBm	dBm	—	55	—
Output IP3	45 - 1800 MHz, tone spacing 6 MHz, P_{OUT} per tone = 5 dBm	dBm	—	36	—
P1dB	—	dBm	—	22	—
Composite Triple Beat, CTB	79 channels, 0 dB Tilt, 34 dBmV per channel output, QAM to 1000 MHz	dBc	—	-74	—
	132 channels, 15 dBmV per channel input			-70	
Composite Second Order, CSO	79 channels, 0 dB Tilt, 34 dBmV per channel output, QAM to 1000 MHz	dBc	—	-66	—
	132 channels, 15 dBmV per channel input			-66	
I_{DD}	$V_{DD} = 8\text{ V}$	mA	—	130	—

Typical Performance Curves: $V_{DD} = 8\text{ V}$

Gain

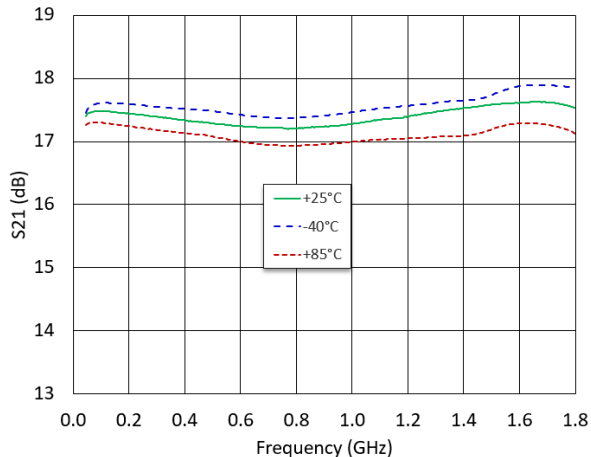

Gain to 3 GHz

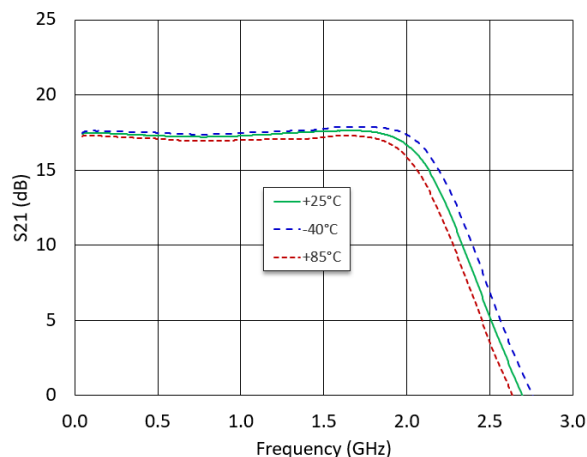

Input Return Loss

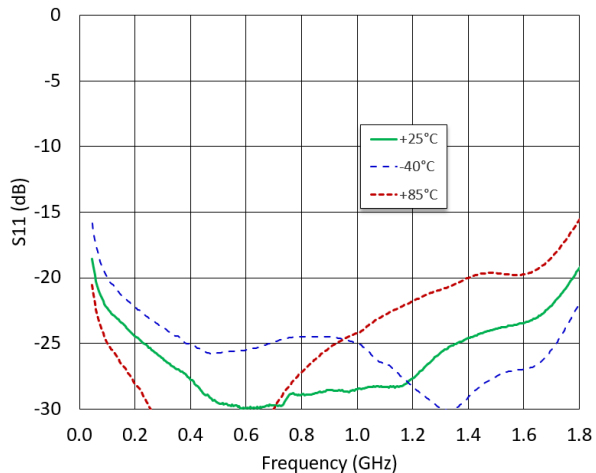

Output Return Loss

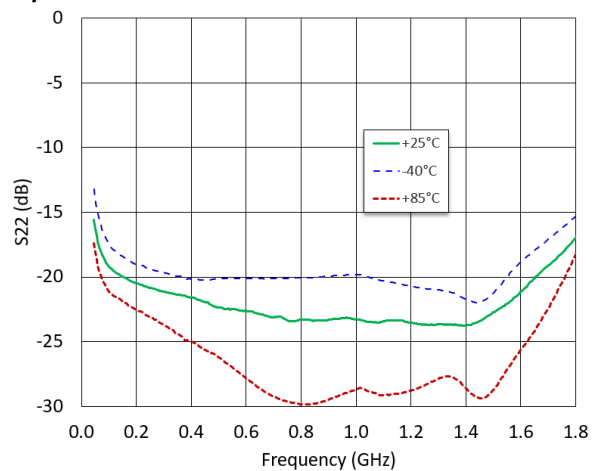

Reverse Isolation

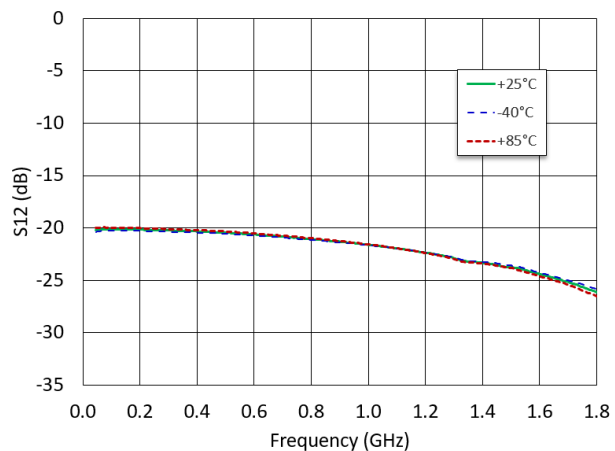

Noise Figure

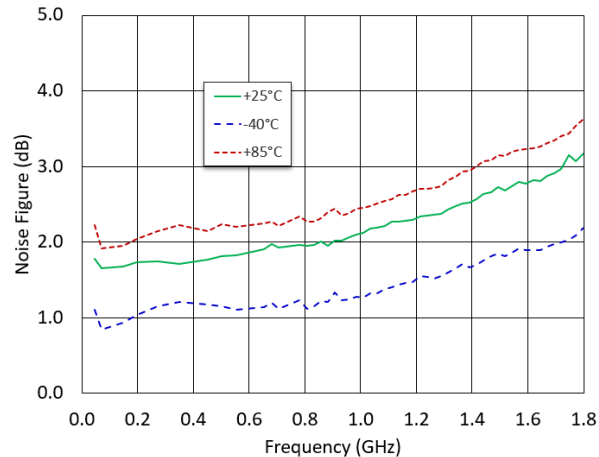

Typical Performance Curves: $V_{DD} = 8\text{ V}$

CSO Lower

79 analog ch + QAM, 0 dB tilt, $P_{OUT} = 34\text{ dBmV per ch}$

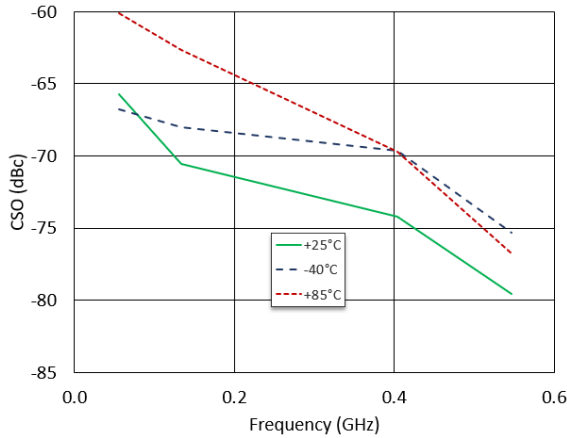

CSO Upper

79 analog ch + QAM, 0 dB tilt, $P_{OUT} = 34\text{ dBmV per ch}$

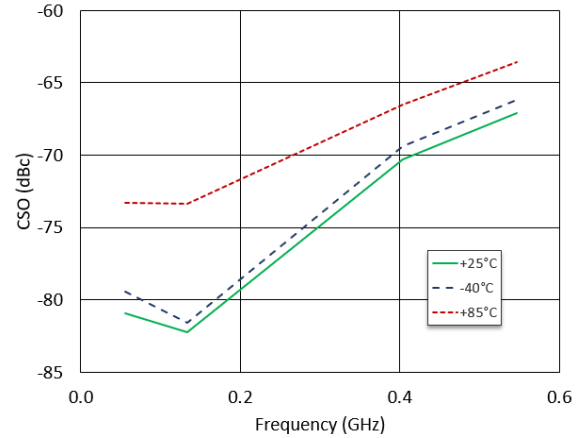

CTB

79 analog ch + QAM, 0 dB tilt, $P_{OUT} = 34\text{ dBmV per ch}$

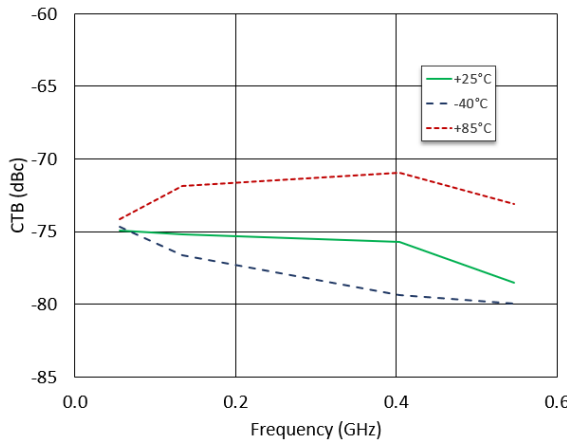

CTB

132 analog ch + QAM, 0 dB tilt, $P_{IN} = 15\text{ dBmV per ch}$

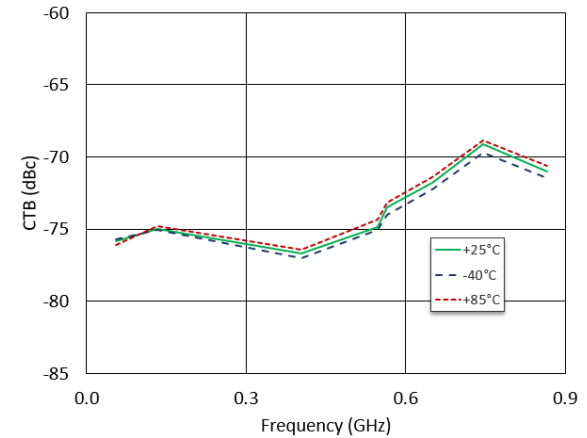

CSO Lower

132 analog ch + QAM, 0 dB tilt, $P_{IN} = 15\text{ dBmV per ch}$

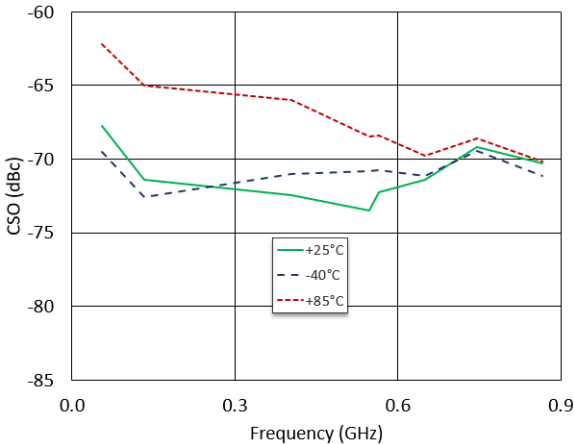

CSO Upper

132 analog ch + QAM, 0 dB tilt, $P_{IN} = 15\text{ dBmV per ch}$

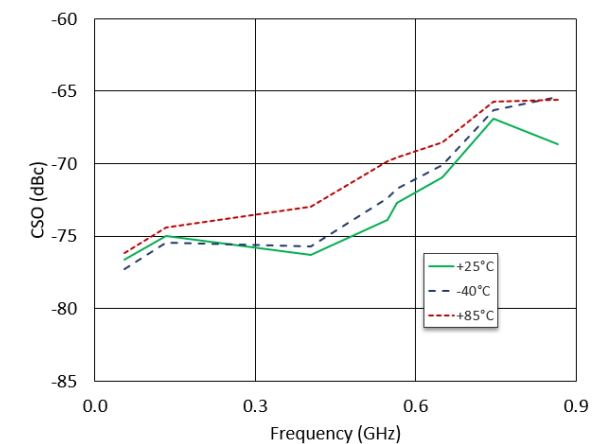

Typical Performance Curves: $V_{DD} = 8\text{ V}$

OIP3, $P_{OUT} = +5\text{ dBm/tone}$

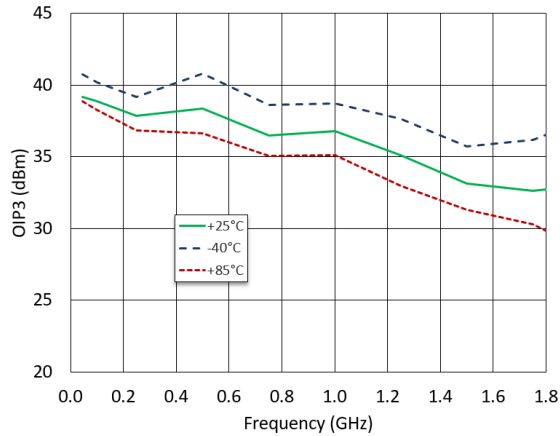

OIP2, $P_{OUT} = +5\text{ dBm/tone}$

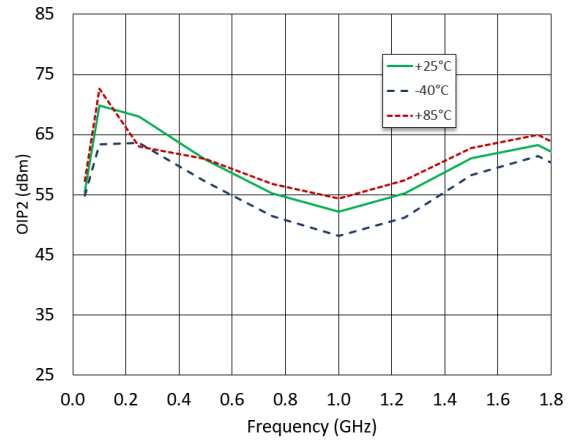

P1dB

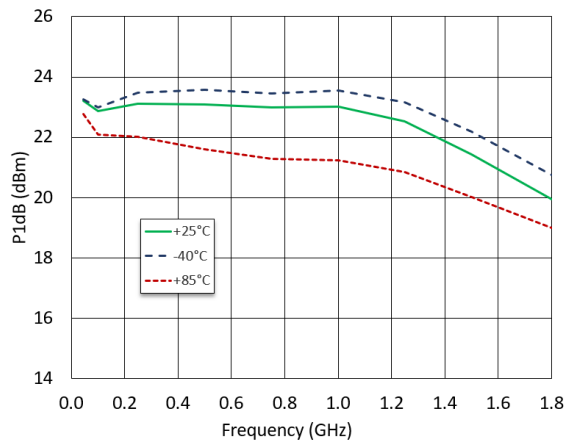

75 Ω , High Linearity, Low Noise, CATV Amplifier 45 - 1800 MHz



MAAM-011300

Rev. V1

Lead Free SOT-89[†]

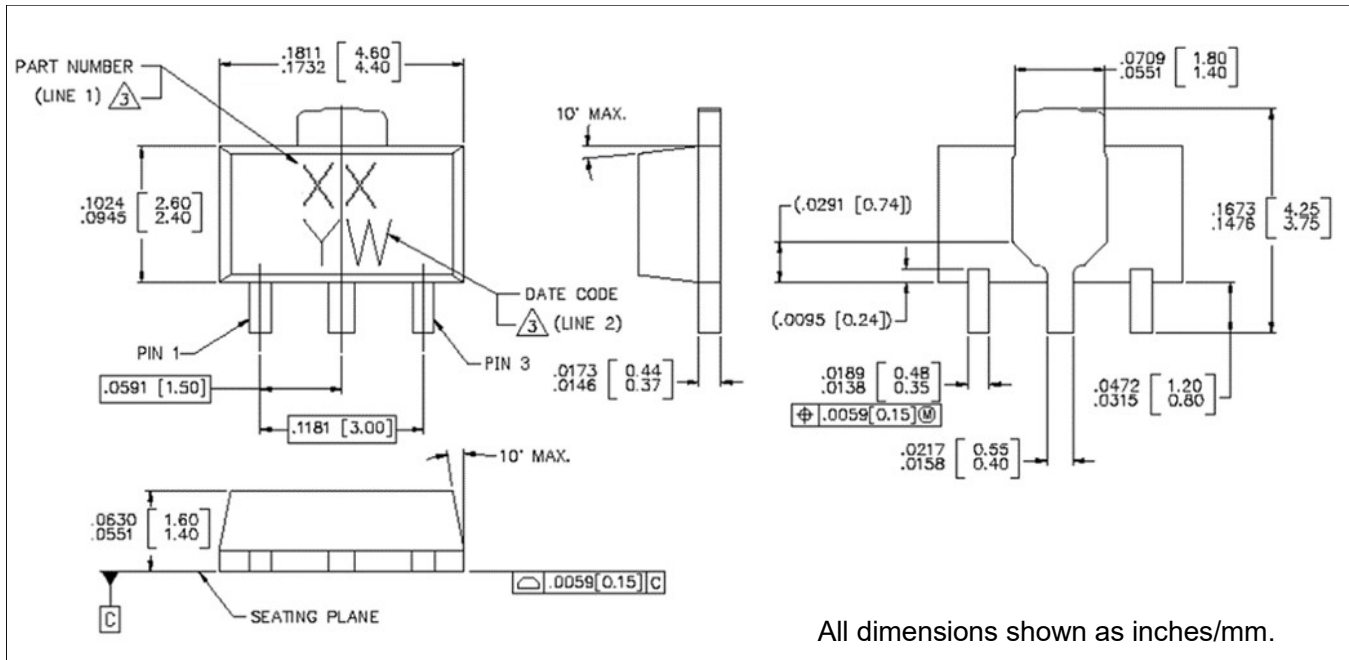

[†] Reference Application Note S2083 for lead-free solder reflow recommendations.
Meets JEDEC moisture sensitivity level 1 requirements.
Plating is 100% matte tin over copper.