

Features

- 75 Ω Input / Output Match
- CTB: -75 dBc
- Noise Figure: 1.8 dB
- Gain: 17 dB, 20 dB
- Lead Free SOT-89 Package
- Halogen-Free “Green” Mold Compound
- RoHS* Compliant and 260°C Reflow Compatible

Description

M/A-COM's MAAMSS0060 CATV amplifier is a GaAs MMIC which exhibits low distortion in a lead free miniature surface mount plastic package. The MAAMSS0060 employs a monolithic single stage design featuring a convenient 75 Ω input/output impedance that minimizes the number of external components required.

The MAAMSS0060 provides low noise and high linearity. It is ideally suited for set top boxes, home gateways, FTTX, Drop Amplifiers, and other broadband internet based applications.

The MAAMSS0060 is fabricated using M/A-COM's PHEMT process to realize low noise and low distortion. The process features full passivation for robust performance and reliability.

Functional Schematic

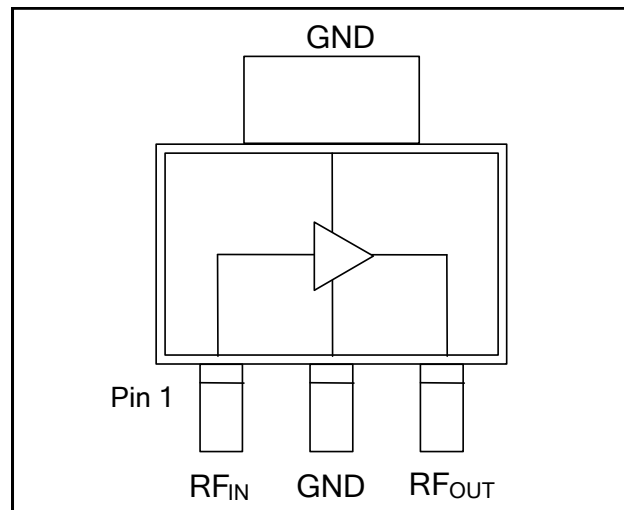

Pin Configuration

Pin No.	Pin Name	Description
1	RF _{IN}	RF Input
2	GND	Ground
3	RF _{OUT}	RF Output / Drain Supply

Ordering Information ^{1,2}

Part Number	Package
MAAMSS0060	Bulk Packaging
MAAMSS0060TR	1000 piece reel
MAAMSS0060TR-3000	3000 piece reel
MAAM-000060-001SMB ²	17 dB Gain Configuration
MAAM-000060-002SMB ²	20 dB Gain Configuration

1. Reference Application Note M513 for reel size information.
2. All sample boards include 5 loose parts.

Absolute Maximum Ratings ^{3,4,5}

Parameter	Absolute Maximum
RF Input Power	6 dBm
Voltage	10.0 volts
Operating Temperature	-40°C to +85°C
Junction Temperature ⁶	+150°C
Storage Temperature	-65°C to +150°C

3. Exceeding any one or combination of these limits may cause permanent damage to this device.
4. M/A-COM does not recommend sustained operation near these survivability limits.
5. These operating conditions will ensure MTTF > 1 x 10⁶ hours.
6. Junction Temperature (T_J) = T_C + Θ_{jc} * (V * I)
Typical thermal resistance (Θ_{jc}) = 58° C/W.
 - a) For T_C = 25°C,
T_J = 81°C @ 8 V, 120 mA
 - b) For T_C = 85°C,
T_J = 136 °C @ 8 V, 110 mA

* Restrictions on Hazardous Substances, European Union Directive 2002/95/EC.

17 dB Gain Configuration

Electrical Specifications: $T_A = 25^\circ\text{C}$, Freq: 50 - 1000 MHz, $V_{DD} = 8$ Volts, $Z_0 = 75 \Omega$

Parameter	Test Conditions	Units	Min.	Typ.	Max.
Gain		dB	15.8	17	17.8
Gain Flatness		dB	—	0.5	1.0
Noise Figure		dB	—	1.8	3.5
Input Return Loss		dB	—	20	—
Output Return Loss		dB	—	20	—
Output IP3	6 MHz Spacing, -10 dBm output per tone	dBm	—	37	—
Composite Triple Beat, CTB	132 channels, +30 dBmV / channel at the output.	dBc	—	-75	—
Composite Second Order, CSO	132 channels, +30 dBmV / channel at the output.	dBc	—	-60	—
P1dB		dBm	—	23	—
I_{DD}	8 Volts	mA	—	120	140

20 dB Gain Configuration

Typical Performance: $T_A = 25^\circ\text{C}$, Freq: 50 - 1000 MHz, $V_{DD} = 8$ Volts, $Z_0 = 75 \Omega$

Parameter	Test Conditions	Units	Min.	Typ.	Max.
Gain		dB	—	20	—
Gain Flatness		dB	—	1	—
Noise Figure		dB	—	1.6	—
Input Return Loss		dB	—	12	—
Output Return Loss		dB	—	12	—
Output IP3	6 MHz Spacing, -10 dBm output per tone	dBm	—	35	—
Composite Triple Beat, CTB	132 channels, +33 dBmV / channel at the output.	dBc	—	-66	—
Composite Second Order, CSO	132 channels, +33 dBmV / channel at the output.	dBc	—	-55	—
P1dB		dBm	—	21	—
I_{DD}	8 Volts	mA	—	120	—

17 & 20 dB Gain Configuration Schematic Including Off-Chip Components

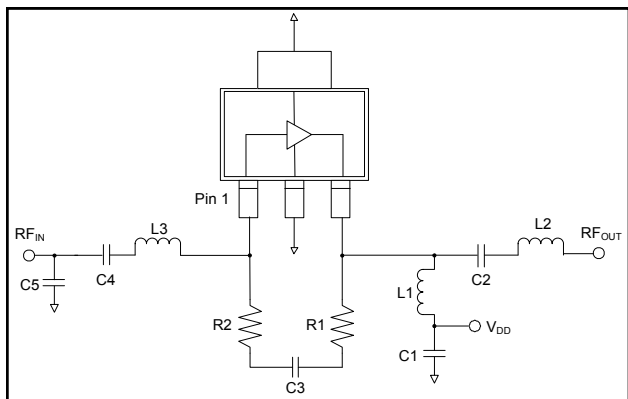

17 dB Gain Configuration Off-Chip Component Values

Component	Value	Package
C1,C3,C4	0.01 μ F	0402
C2	470 pF	0402
C5	0.7 pF	0402
L1 ⁷	1 μ H	1210
L2	4.7 nH	0402
L3	8.2 nH	0402
R1	560 Ω	0402
R2	91 Ω	0402

7. L1 supplied from EPCOS, part number B82422A1102K100

17 & 20 dB Gain Configuration Recommended Board Layout

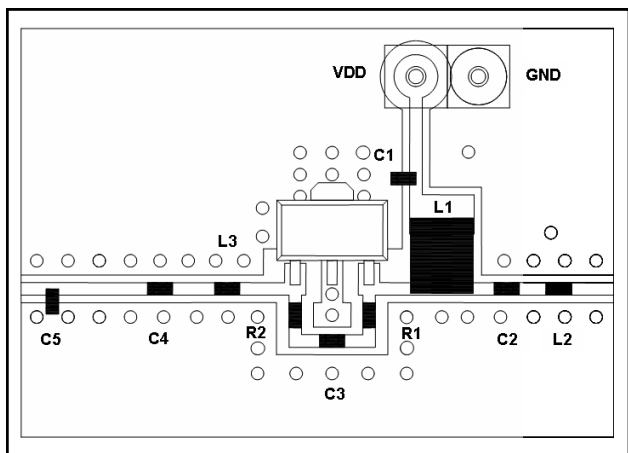

20 dB Gain Configuration Off-Chip Component Values

Component	Value	Package
C1,C2,C3,C4	0.01 μ F	0402
C5	0.75 pF	0402
L1 ⁸	1.5 μ H	1210
L2	10 nH	0402
L3	12 nH	0402
R1	750 Ω	0402
R2	360 Ω	0402

8. L1 supplied from EPCOS, part number B82422A1152K100

Typical Performance Curves: 17dB Gain Configuration

Gain to 1 GHz over Temperature

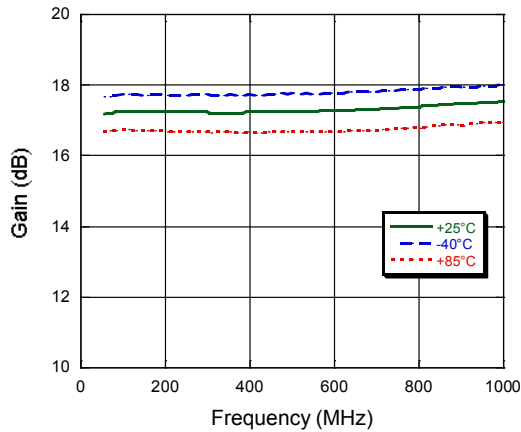

Gain to 3 GHz over Temperature

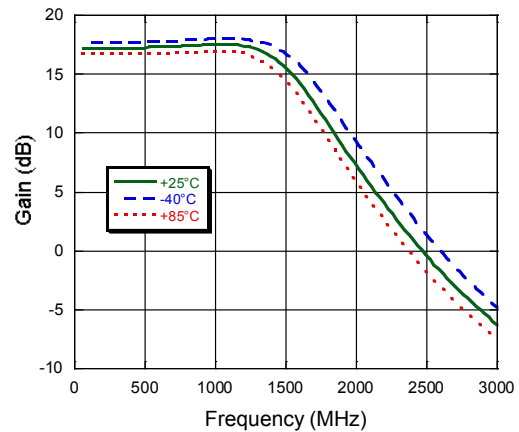

Input Return Loss over Temperature

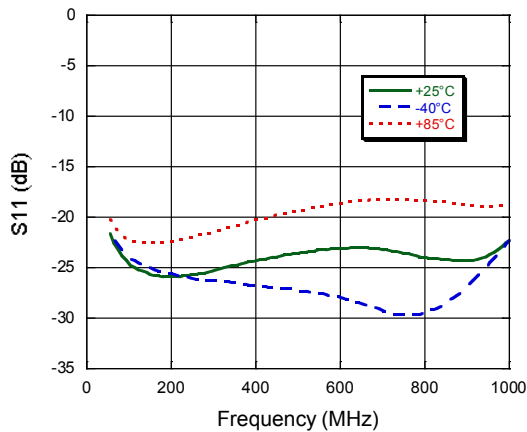

Output Return Loss over Temperature

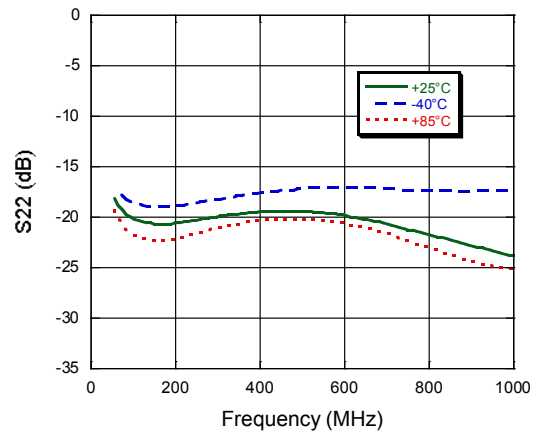

Noise Figure

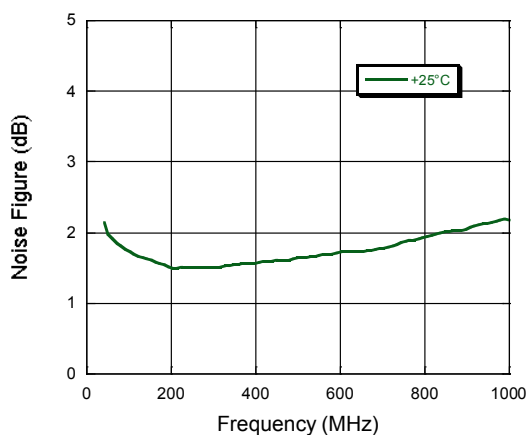

Typical Performance Curves: 20 dB Gain Configuration

Gain to 1 GHz

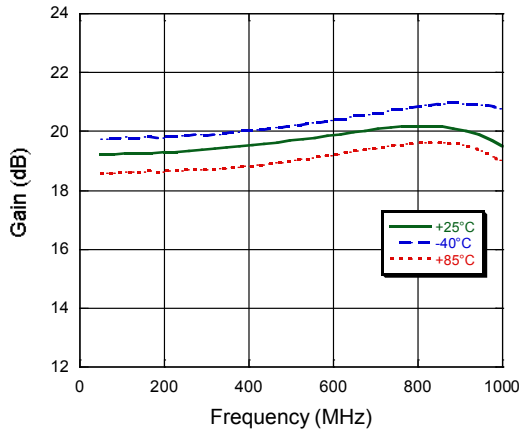

Gain to 3 GHz

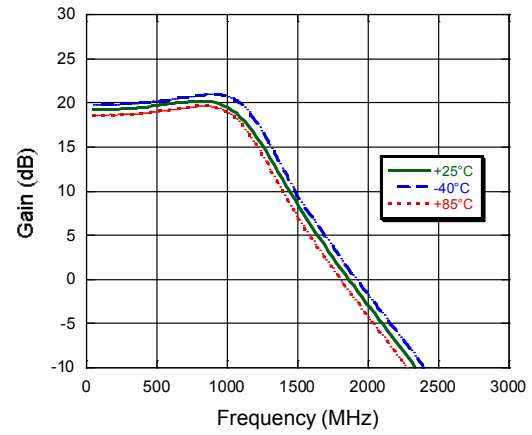

Input Return Loss

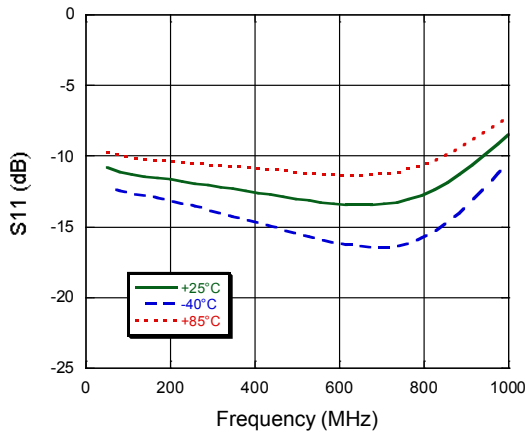

Output Return Loss

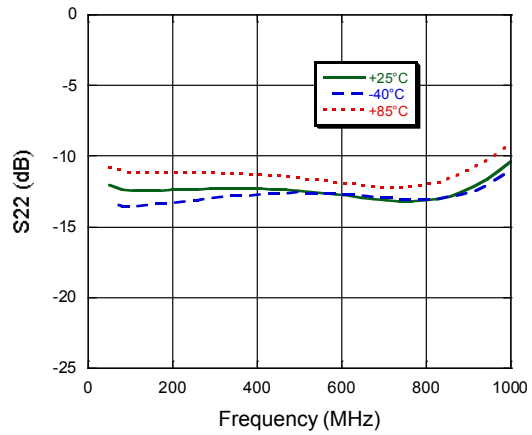

Noise Figure

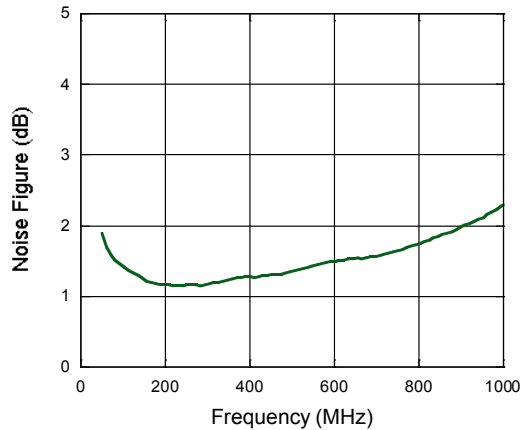

Lead-Free SOT-89 Plastic Package[†]

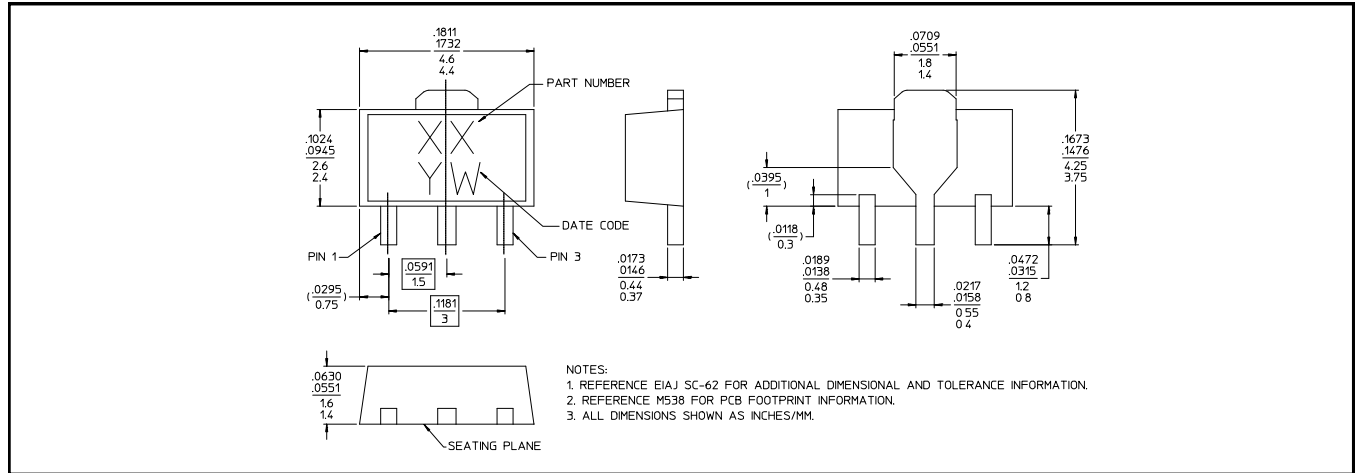

[†] Reference Application Note M538 for lead-free solder reflow recommendations.
 Meets JEDEC moisture sensitivity level 1 requirements.
 Plating is 100% matte tin over copper.

Handling Procedures

Please observe the following precautions to avoid damage:

Static Sensitivity

Gallium Arsenide Integrated Circuits are sensitive to electrostatic discharge (ESD) and can be damaged by static electricity. Proper ESD control techniques should be used when handling these devices.