

Features

- Fully Integrated Power Amplifier
- Wide Bandwidth 10.0 - 15.35 GHz
- 27 dB Small Signal Gain
- 42 dBm Third Order Intercept Point (OIP3)
- 33.5 dBm Output P1dB
- Integrated Power Detector
- Bias 5 V, 2.2 A
- Lead-Free 7mm 48-lead QFN Package
- RoHS* Compliant

Description

The MAAP-010150 is a packaged linear power amplifier that operates over the range 10.0 - 15.35 GHz. The device typically provides 27 dB of gain and 42 dBm OIP3 with more than 33.5 dBm of Output P1dB.

This power amplifier is assembled in a lead free, fully molded 7 mm QFN package and consists of a 3 stage power amplifier with integrated, on-chip peak power detector and envelope detector. The device includes on-chip ESD protection structures to ease the implementation and volume assembly.

The device is well suited for use in the 10, 11, 13, 15 GHz cellular backhaul applications.

Ordering Information^{1,2}

Part Number	Package
MAAP-010150	Bulk
MAAP-010150-TR0500	Tape and Reel
MAAP-010150-001SMB	Sample Board

1. Reference Application Note M513 for reel size information.
2. All sample boards include 5 loose parts.

Functional Schematic

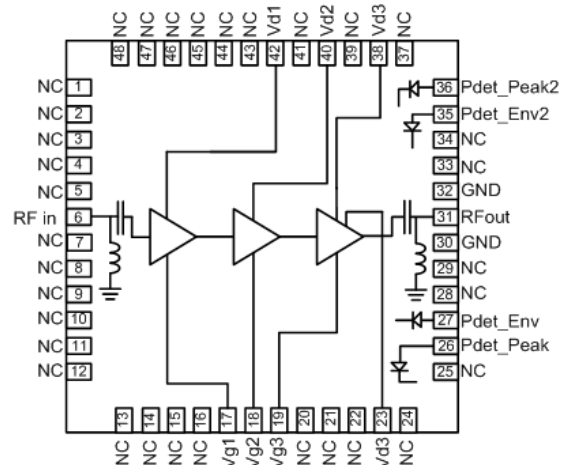

Pin Configuration^{3,4}

Pin No.	Function	Pin No.	Function
1 - 5	NC	31	RF Output
6	RF Input	32	GND
7 - 16	NC	33, 34	NC
17	VG1	35	Pdet_Env2
18	VG2	36	Pdet_Peak2
19	VG3	37	NC
20 - 22	NC	38	VD3
23	VD3	39	NC
24, 25	NC	40	VD2
26	Pdet_Peak	41	NC
27	Pdet_Env	42	VD1
28, 29	NC	43 - 48	NC
30	GND	49	Paddle

3. MACOM recommends connecting unused package pins to ground.
4. The exposed pad centered on the package bottom must be connected to RF, DC and thermal ground.

* Restrictions on Hazardous Substances, European Union Directive 2011/65/EU.

Electrical Specifications:

Freq. = 10.0 - 15.35 GHz, I_{DQ} = 2.2 A, T_A = 25°C, V_D = 5 V, Z₀ = 50 Ω

Parameter	Test Conditions	Units	Min.	Typ.	Max.
Gain	10.00 - 12.00 GHz	dB	26	28.5	—
	12.00 - 13.50 GHz		26	27.5	
	13.50 - 15.35 GHz		26	27.5	
P1dB, @ 1 dB Compression	10.00 - 12.00 GHz	dBm	—	33.0	—
	12.00 - 13.50 GHz		—	33.5	
	13.50 - 15.35 GHz		—	34.0	
P _{SAT}	10.00 - 12.00 GHz	dBm	33.5	36.5	—
	12.00 - 13.50 GHz		33.5	36.0	
	13.50 - 15.35 GHz		33.5	36.0	
OIP3	10.00 - 12.00 GHz	dBm	41	42	—
	12.00 - 13.50 GHz		41	42	
	13.50 - 15.35 GHz		38.5	41	
Input Return Loss	—	dB	—	10	—
Output Return Loss	—	dB	—	12	—
PAE, @ 1 dB Compression	—	%	—	20	—
Quiescent Current	—	mA	2000	2200	2400

Absolute Maximum Ratings^{5,6,7}

Parameter	Rating
Drain Voltage (V _D 1,2,3) (Under No RF Drive)	9 V
Drain Voltage (V _D 1,2,3) (Under RF Drive)	5.5 V
Gate Voltage (V _G 1,2,3)	-3 V
Storage Temperature	-65°C to +150°C
Junction Temperature	+175°C

5. Exceeding any one or combination of these limits may cause permanent damage to this device.
6. MACOM does not recommend sustained operation near these survivability limits.
7. Operating at nominal conditions with T_J ≤ +150°C will ensure MTTF > 1 x 10⁶ hours.

Maximum Operating Ratings^{8,9}

Parameter	Rating
P _{DISS}	16.5 W
Operating Temperature	-40°C to +85°C
Junction Temperature	+150°C

8. Junction temperature directly affects device MTTF. Junction temperature should be kept as low as possible to maximize lifetime. Thermal resistance, Θ_{Jc} is 5.45 °C/W.
9. For saturated performance, it is recommended that the sum of (2V_{DD} + abs (V_{GG})) < 12 V.

PCB Layout

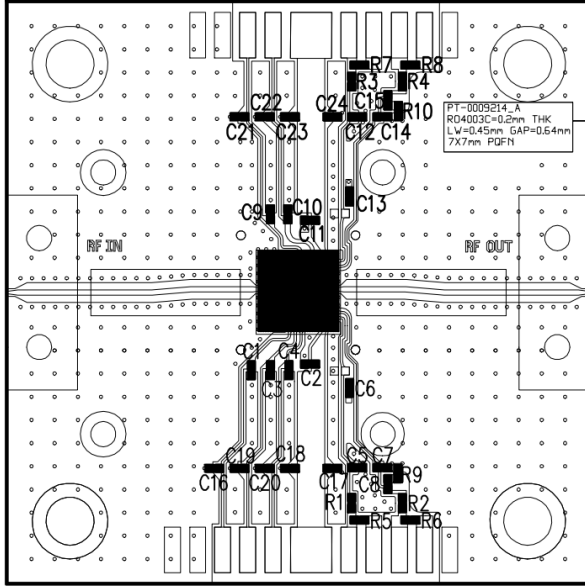

Parts List

Part	Value	Case Style
C1,C2,C3,C4,C5,C6,C7, C8,C9,C10,C11,C12, C13,C14,C15,	100 nF	0402
C16,C17,C18,C19,C20, C21,C22,C23,C24	2.2 μ F	0603
R1,R2, R3,R4	100 Ω	0402
R5,R6,R7,R8	5600 Ω	0402
R9,R10	10 K Ω	0402

Application Schematic

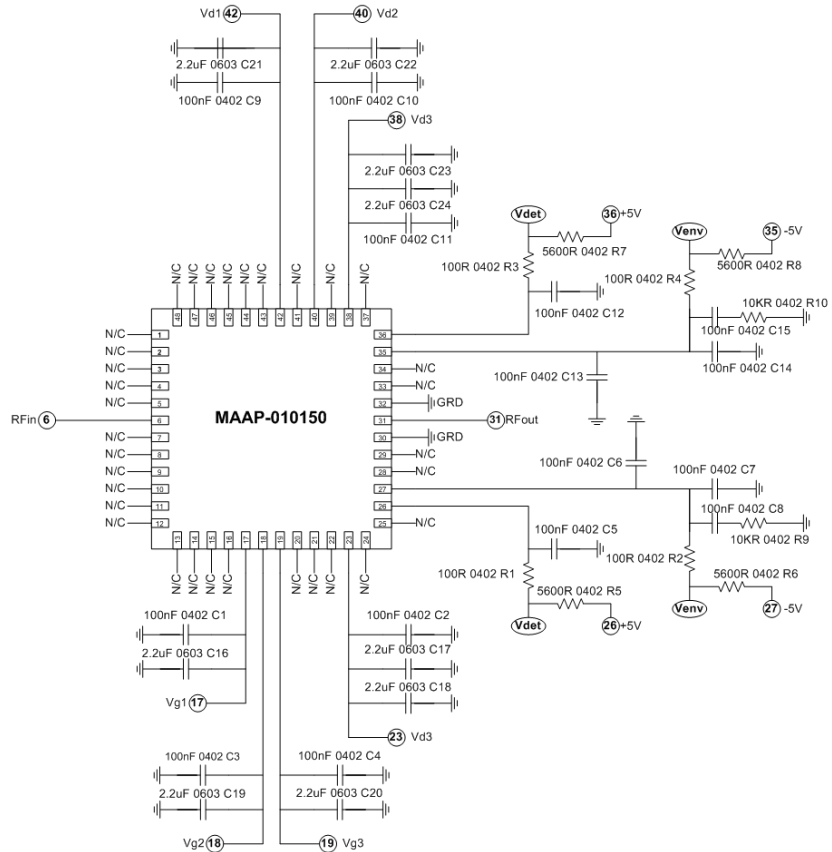

Biasing

All gates should be pinched-off, $V_G < -2$ V, before applying the drain voltage, $V_D = 5$ V (do not exceed maximum V_{DG} value for RF drive condition). Then the gate voltages can be increased until the desired quiescent drain current is reached in each stage. The recommended quiescent bias is $V_D = 5$ V, $I_{D1} + I_{D2} + I_{D3} = 2200$ mA (total). The performance in this datasheet has been measured with a fixed gate voltage and no drain current regulation under large signal operation. It is also possible to regulate the drain current dynamically, to limit the DC power dissipation under RF drive. To turn off the device, the turn on bias sequence should be followed in reverse.

Detector Operation

MAAP-010150 includes dual power and envelope detectors. These are included on both sides of the device to ease integration onto larger radio boards. As per the application schematic, the power detector requires an external 5 V supply and the envelope detector requires -5 V. The output from the resistive voltage divider can be fed into a ADC or multimeter for the result.

Bias Arrangement

Each DC pin (V_{D1} , V_{D2} , V_{D3} and V_{G1} , V_{G2} , V_{G3}) needs to have bypass capacitance of 100 nF mounted as close to the packaged device as possible.

Handling Procedures

Please observe the following precautions to avoid damage:

Static Sensitivity

These electronic devices are sensitive to electrostatic discharge (ESD) and can be damaged by static electricity. Proper ESD control techniques should be used when handling these CDM class C1, HBM Class 0A devices.

Power Amplifier 10.0 - 15.35 GHz

Rev. V2

Typical Performance Curves: $V_D = 5\text{ V}$, $I_{DQ} = 2.2\text{ A}$, $V_G = -1.05 \sim -0.85\text{ V}$, $T_A = +25^\circ\text{C}$

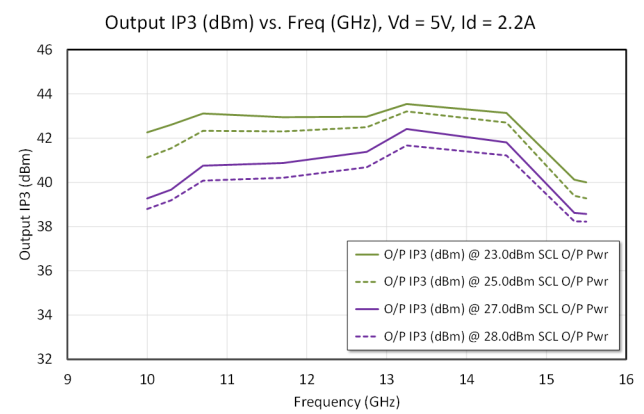
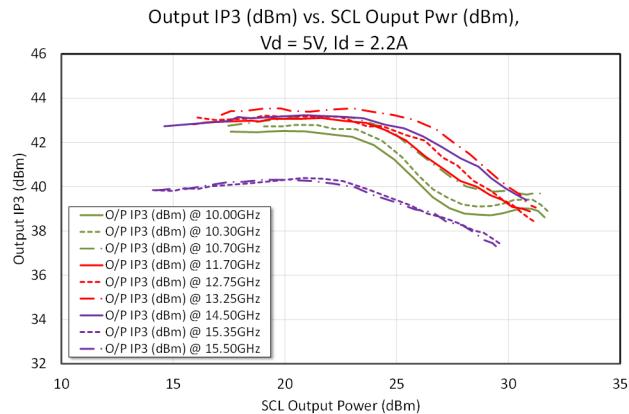
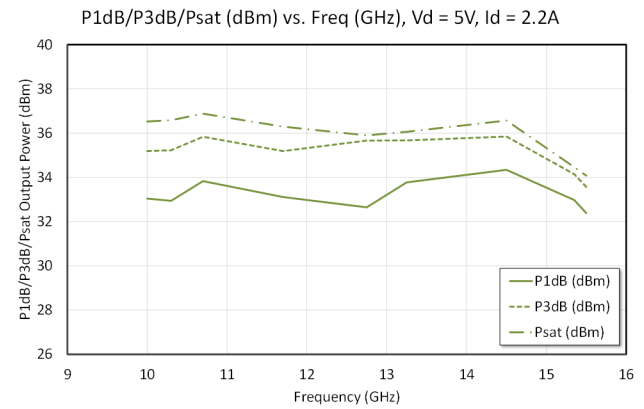
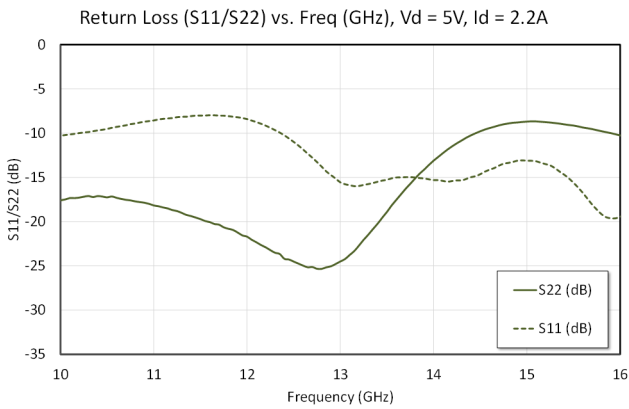
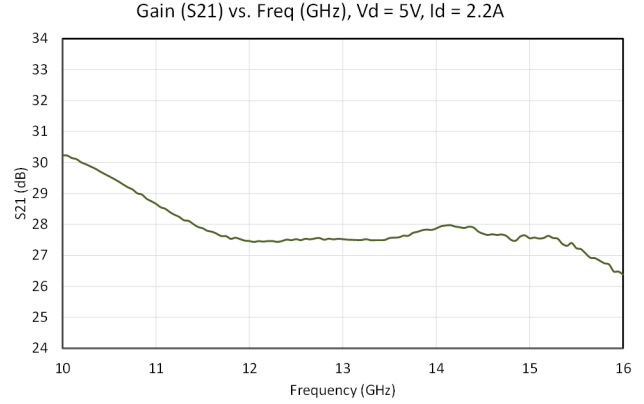
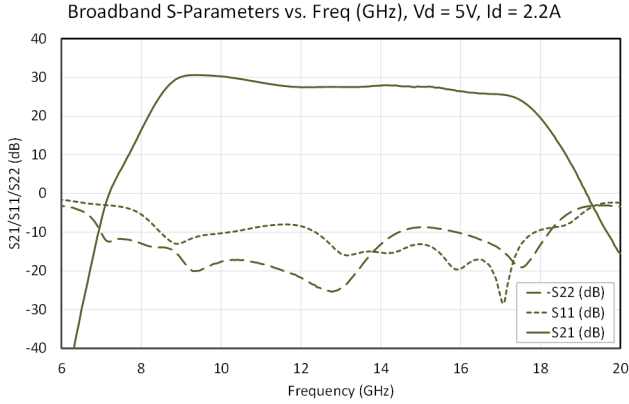

Power Amplifier 10.0 - 15.35 GHz

Rev. V2

Typical Performance Curves: $V_D = 5\text{ V}$, $I_{DQ} = 2.2\text{ A}$, $V_G = -1.05 \sim -0.85\text{ V}$, $T_A = +25^\circ\text{C}$

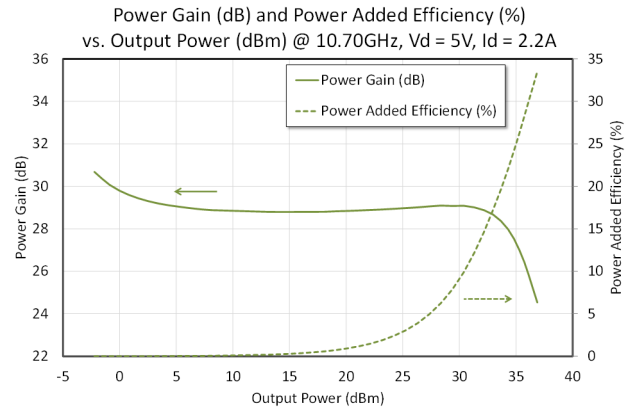
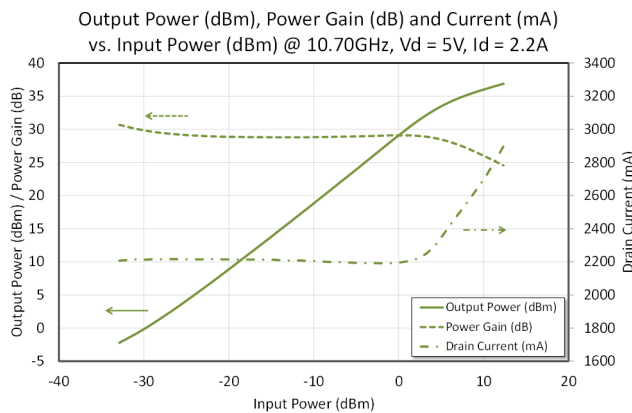
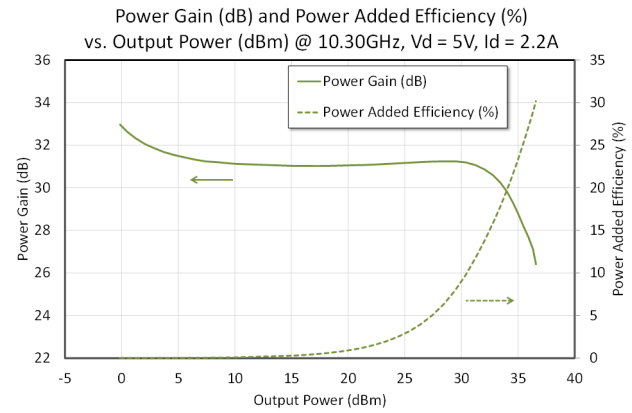
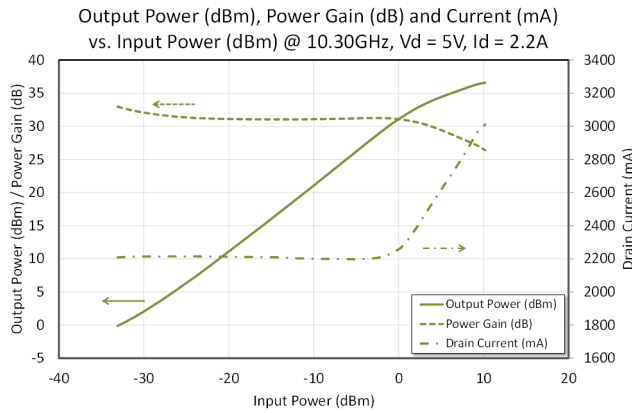
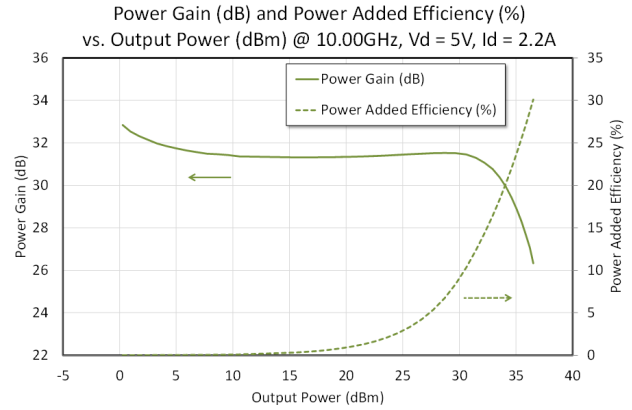
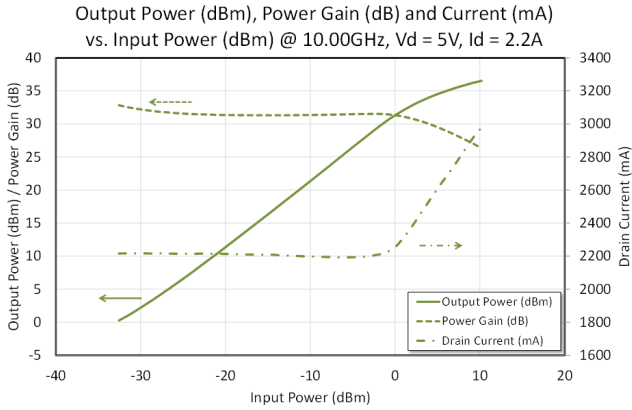

Power Amplifier 10.0 - 15.35 GHz

Rev. V2

Typical Performance Curves: $V_D = 5\text{ V}$, $I_{DQ} = 2.2\text{ A}$, $V_G = -1.05 \sim -0.85\text{ V}$, $T_A = +25^\circ\text{C}$

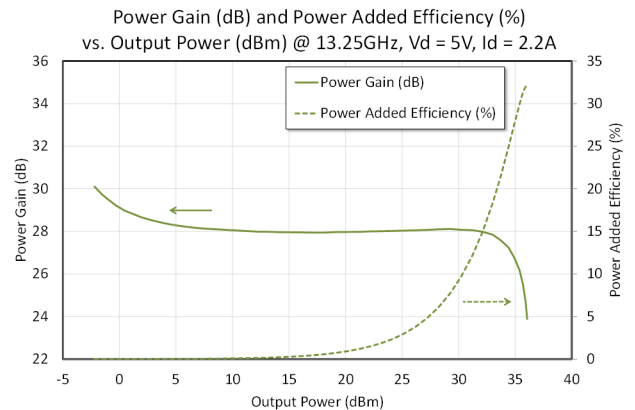
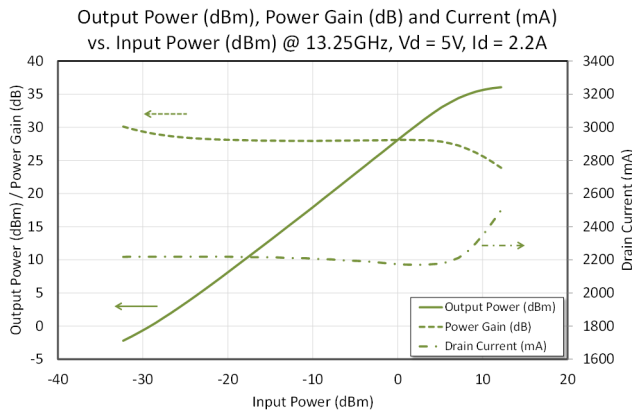
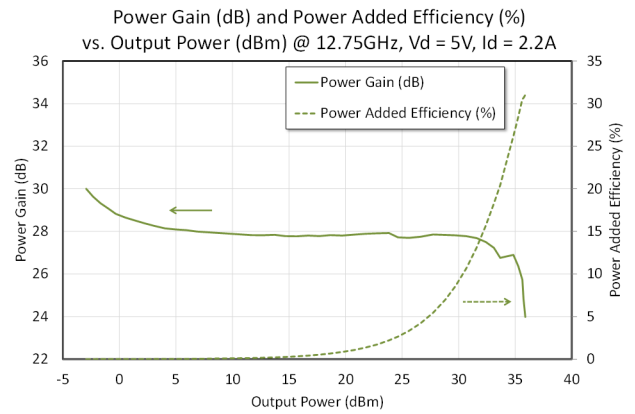
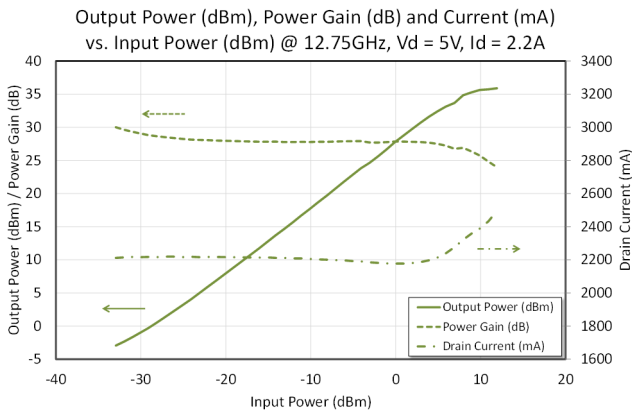
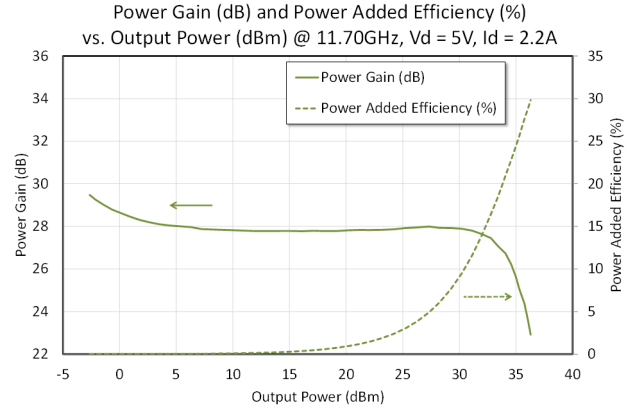
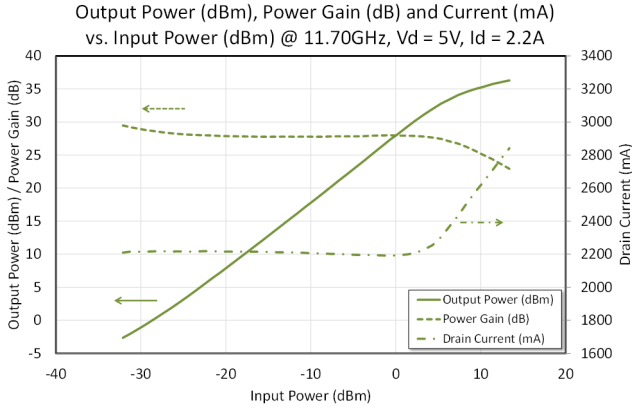

Power Amplifier 10.0 - 15.35 GHz

Rev. V2

Typical Performance Curves: $V_D = 5\text{ V}$, $I_{DQ} = 2.2\text{ A}$, $V_G = -1.05 \sim -0.85\text{ V}$, $T_A = +25^\circ\text{C}$

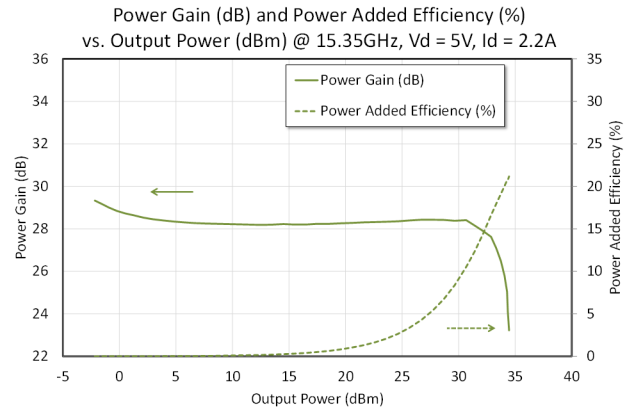
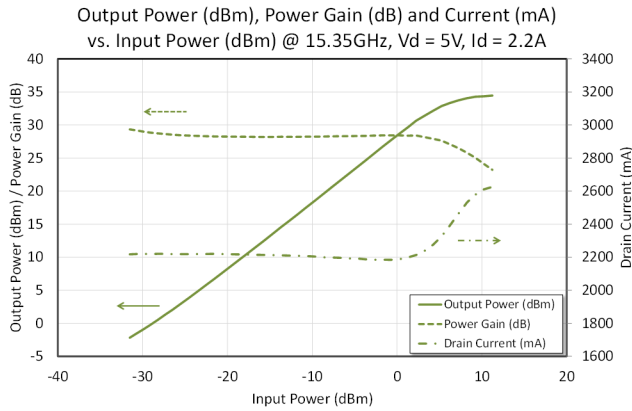
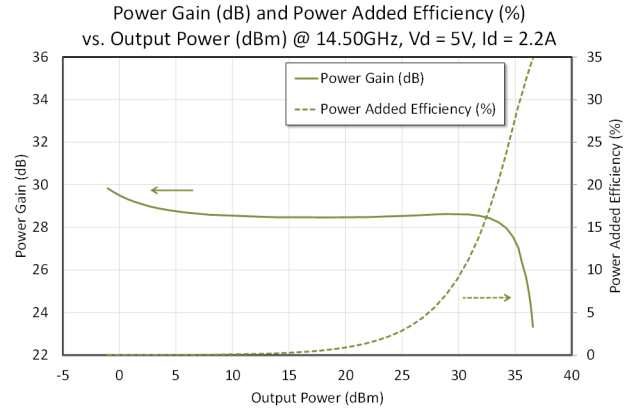
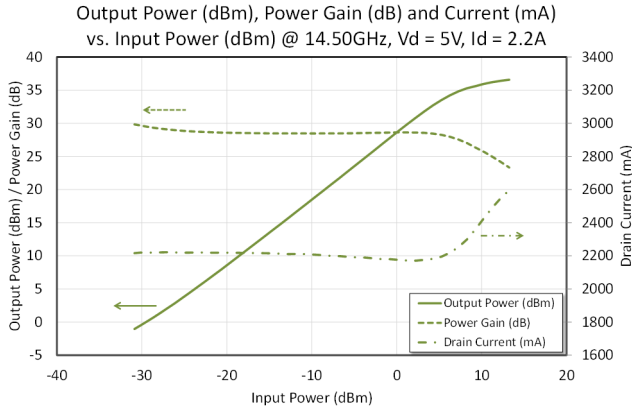

Typical Performance Curves: $V_D = 5\text{ V}$, $I_{DQ} = 2.2\text{ A}$, $V_G = -1.05 \sim -0.85\text{ V}$, $T_A = +25^\circ\text{C}$

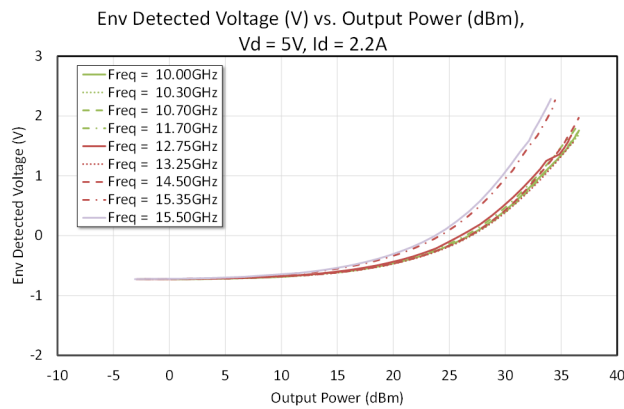
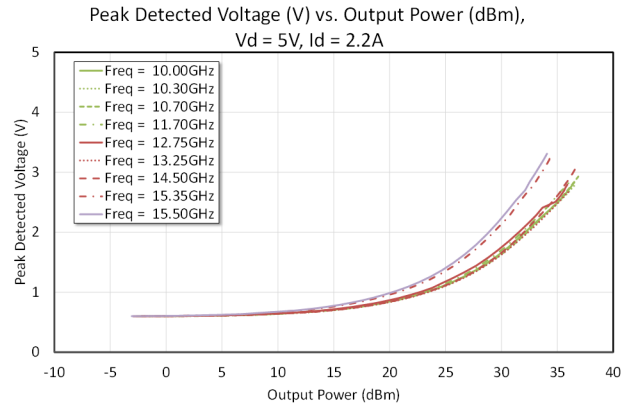
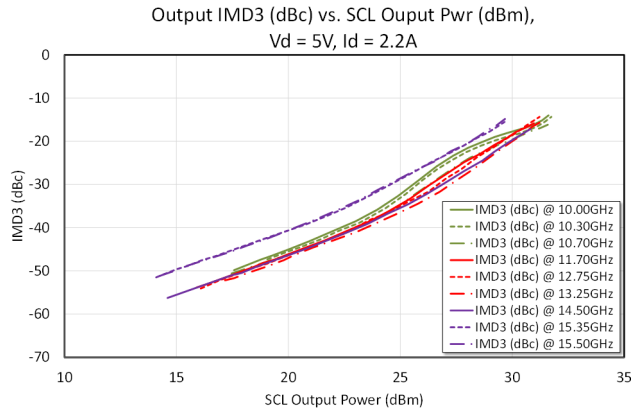

Power Amplifier 10.0 - 15.35 GHz

Rev. V2

Typical Performance Curves: $V_D = 5\text{ V}$, $I_{DQ} = 2.2\text{ A}$, $V_G = -1.05 \sim -0.85\text{ V}$, $T_A = -40^\circ\text{C} \sim +85^\circ$

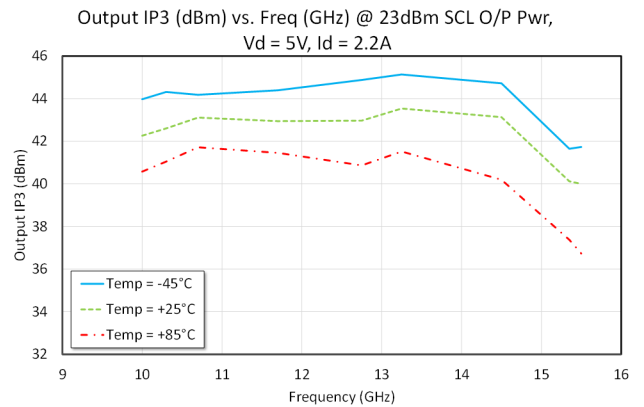
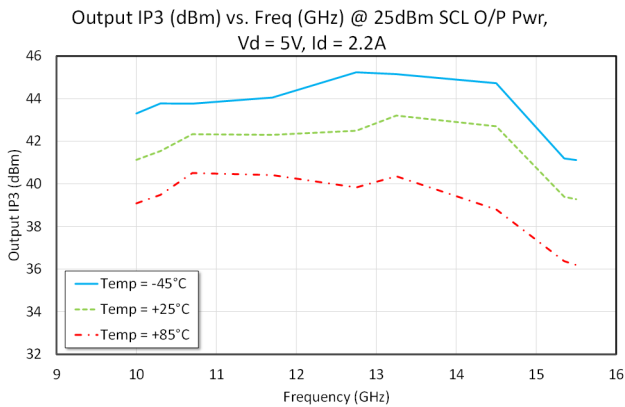
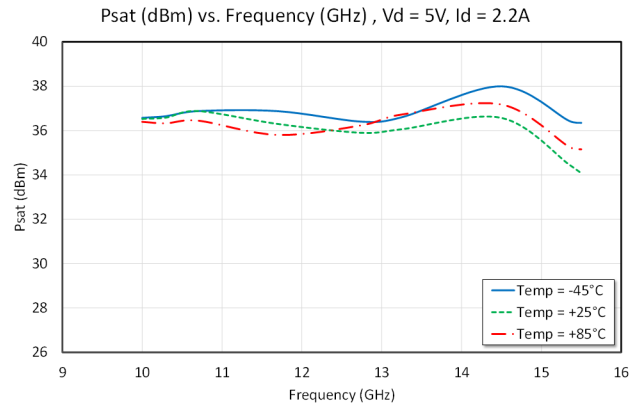
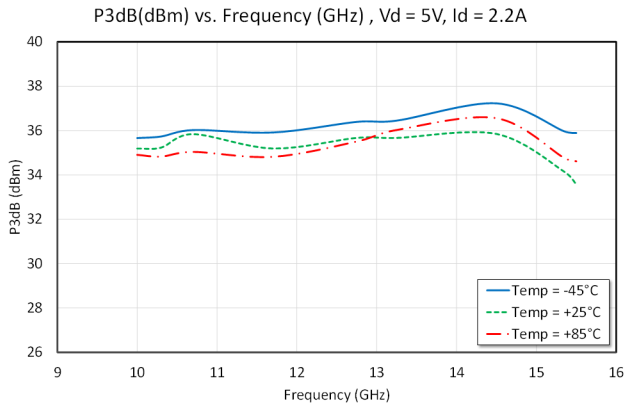
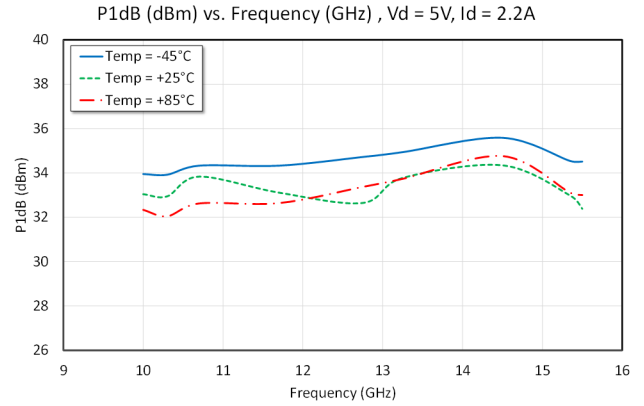
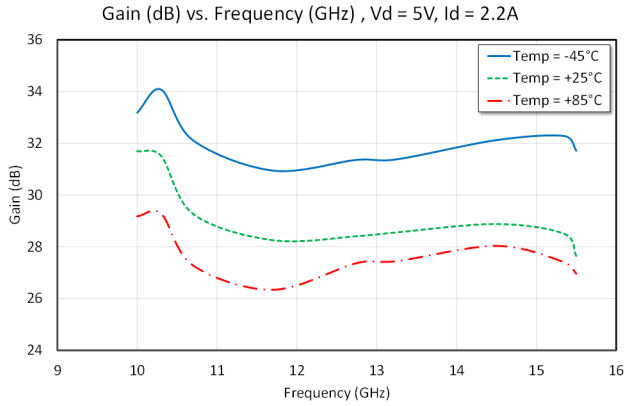

Power Amplifier 10.0 - 15.35 GHz

Rev. V2

Typical Performance Curves: $V_D = 5\text{ V}$, $I_{DQ} = \text{Various}$, $V_G = -0.85 \sim -1.65\text{ V}$, $T_A = +25^\circ\text{C}$

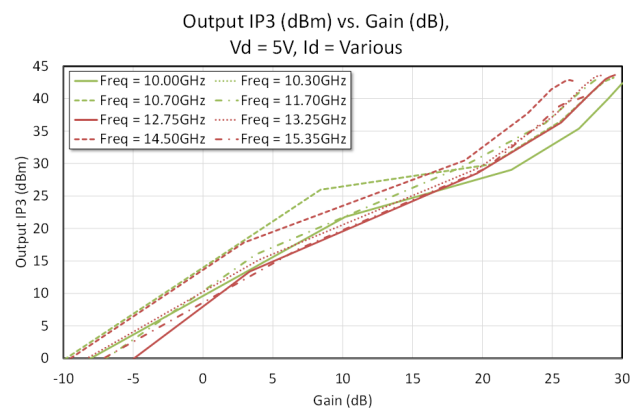
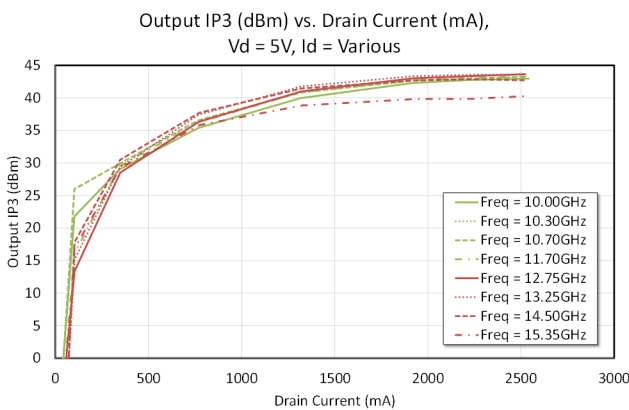
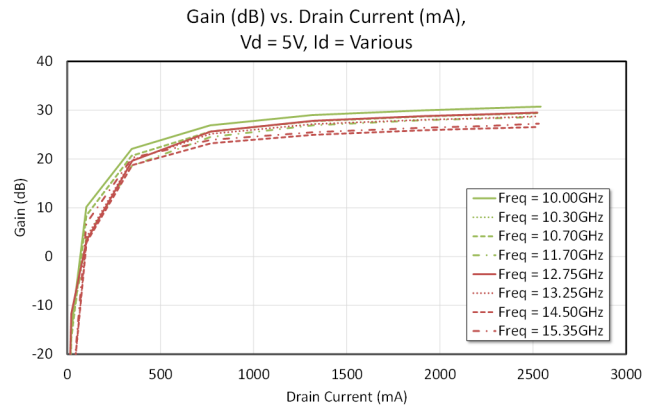
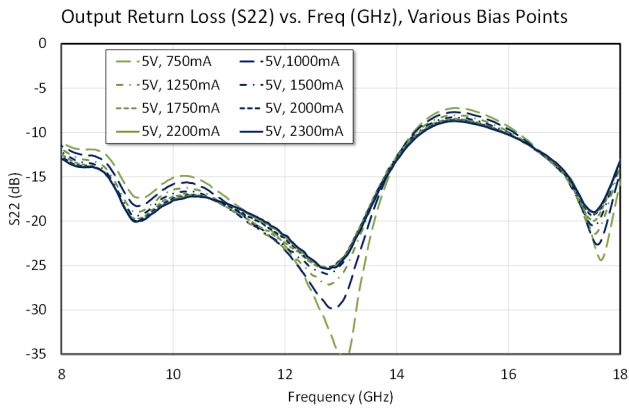
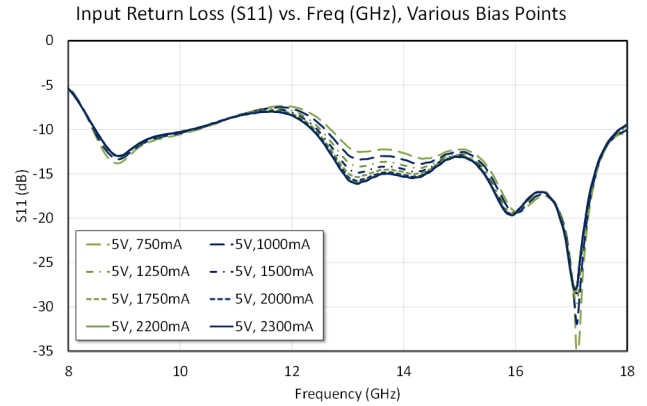
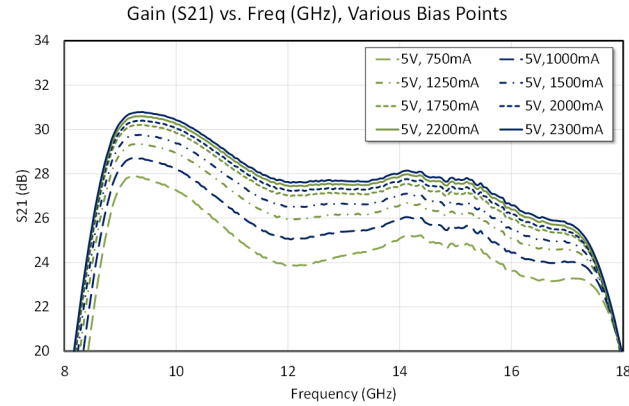

Lead-Free 7 mm 48-Lead PQFN†

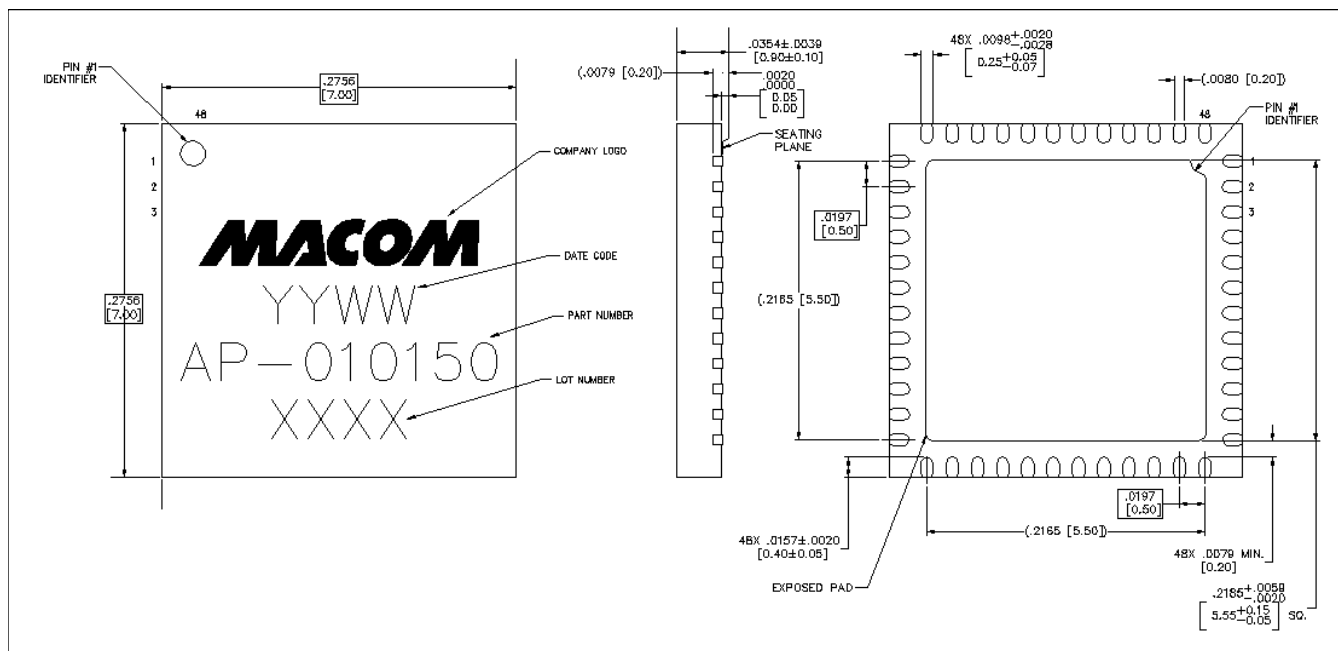

† Reference Application Note S2083 for lead-free solder reflow recommendations.
Meets JEDEC moisture sensitivity level 3 requirements.
Plating is NiPdAuAg