

## Features

- Linear Gain: 27 dB
- Saturated Output Power: +39 dBm Pulsed
- 50  $\Omega$  Input / Output Match
- Lead-Free 5 mm 20-lead PQFN Package
- Halogen-Free “Green” Mold Compound
- RoHS\* Compliant and 260°C Reflow Compatible

## Description

The MAAP-010171 is a 2-stage, 8 W saturated S-band power amplifier in a 5mm 20 lead PQFN package, allowing easy assembly. This product is fully matched to 50 ohms on both the input and output. It can be used as a power amplifier stage or as a driver stage in high power pulsed applications.

It is ideally suited for Air Traffic Control, Weather, Military and S-band radar applications.

Each device is 100% RF tested to ensure performance compliance.

## Functional Schematic

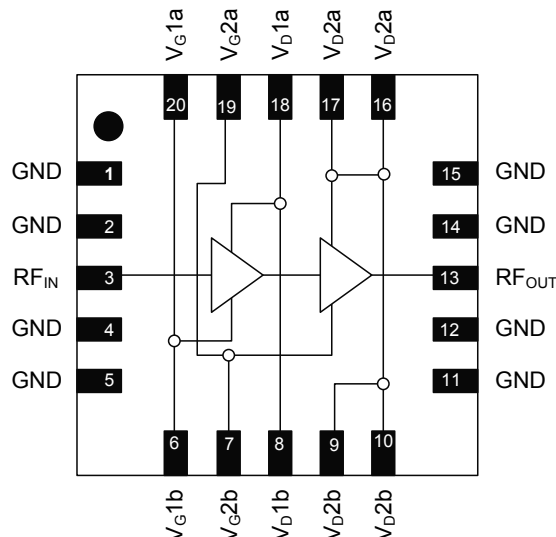

## Pin Configuration<sup>2</sup>

Pin No.	Function	Pin No.	Function
1	Ground	11	Ground
2	Ground	12	Ground
3	RF <sub>IN</sub>	13	RF <sub>OUT</sub>
4	Ground	14	Ground
5	Ground	15	Ground
6	V <sub>G</sub> 1b	16	V <sub>D</sub> 2a
7	V <sub>G</sub> 2b	17	V <sub>D</sub> 2a
8	V <sub>D</sub> 1b	18	V <sub>D</sub> 1a
9	V <sub>D</sub> 2b	19	V <sub>G</sub> 2a
10	V <sub>D</sub> 2b	20	V <sub>G</sub> 1a
		21	Paddle <sup>3</sup>

2. MACOM recommends connecting unused package pins to ground.

3. The exposed pad centered on the package bottom must be connected to RF, DC and thermal ground.

## Ordering Information<sup>1</sup>

Part Number	Package
MAAP-010171-TR0500	500 piece reel
MAAP-010171-TR1000	1000 piece reel
MAAP-010171-000SMB	Sample Board

1. Reference Application Note M513 for reel size information.

\* Restrictions on Hazardous Substances, European Union Directive 2011/65/EU.

## Electrical Specifications:

Freq. 2.5 - 3.5 GHz,  $V_{DD} = 9\text{ V}$  Pulsed, 100  $\mu\text{s}$  Pulse Width, 10% Duty Cycle,  $Z_0 = 50\ \Omega$

Parameter	Units	Min.	Typ.	Max.
Gain	dB	25	27	—
Input Return Loss	dB	—	10	—
Output Return Loss	dB	—	10	—
$P_{SAT}$	dBm	37	39	—
Small Signal Current ( $I_{DD}$ )	A	—	1	—
Efficiency	%	—	38	—

## Absolute Maximum Ratings<sup>4,5</sup>

Parameter	Absolute Maximum
Input Power	22 dBm
Supply Voltage	11 V
Gate Current	25 mA
Duty Cycle	50 %
Operating Temperature	-40°C to +85°C
Junction Temperature <sup>6,7</sup>	+150°C
Storage Temperature	-55°C to +150°C

4. Exceeding any one or combination of these limits may cause permanent damage to this device.
5. MACOM does not recommend sustained operation near these survivability limits.
6. Operating at nominal conditions with  $T_J \leq 150^\circ\text{C}$  will ensure  $MTTF > 1 \times 10^6$  hours.
7. Junction Temperature ( $T_J$ ) =  $T_C + \Theta_{JC} * (V * I)$ .  
Typical thermal resistance ( $\Theta_{JC}$ ) = 5.75°C/W

## Handling Procedures

Please observe the following precautions to avoid damage:

## Static Sensitivity

Gallium Arsenide Integrated Circuits are sensitive to electrostatic discharge (ESD) and can be damaged by static electricity. Proper ESD control techniques should be used when handling these class 1A devices.

## Schematic

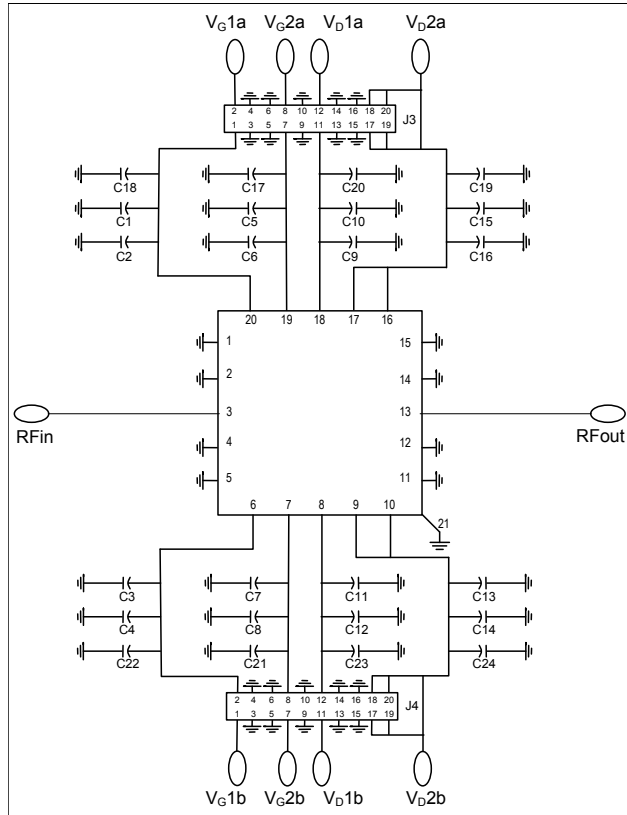

## Recommended PCB Layout

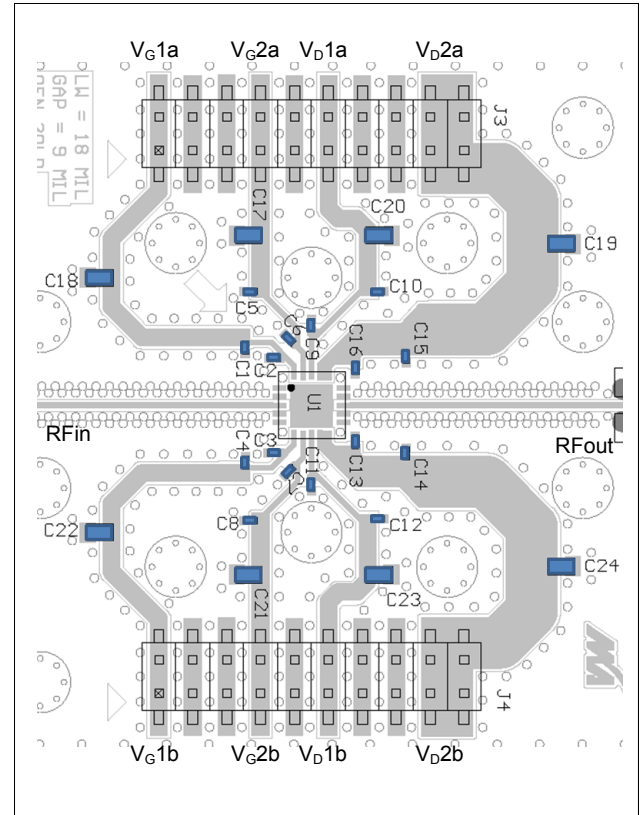

## Parts List

Component	Value	Package
C1, C4, C5, C8, C10, C12, C14, C15	1000 pF	0402
C2, C3, C6, C7, C9, C11, C13, C16	100 pF	0402
C17, C18, C21, C22	1 μF	0805
C19, C20, C23, C24	10 nF	0805

## Operating the MAAP-010171

To operate, follow these steps.

1. Apply  $V_G$  between -1 V and -0.5 V to set  $IDQ$  to 1 A
2. Apply  $V_{DD}$  Pulsed
3. Apply RF Power ON
4. The RF ports (pins 3 & 13) are not DC blocked.  
Do not apply DC voltage directly onto these pins.
5. Ramp down or shut down in reverse order.

## Typical Performance Curves

### S-Parameters

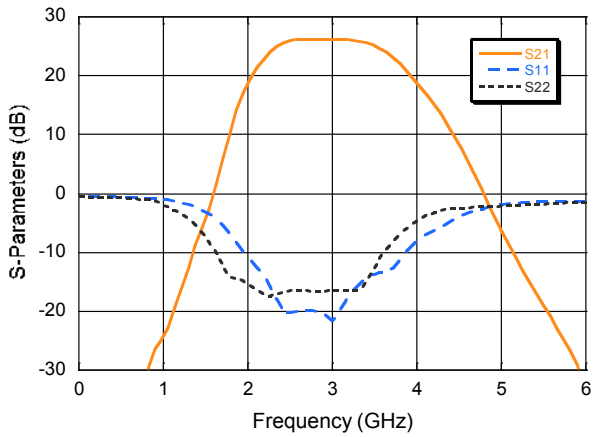

### Small Signal Gain

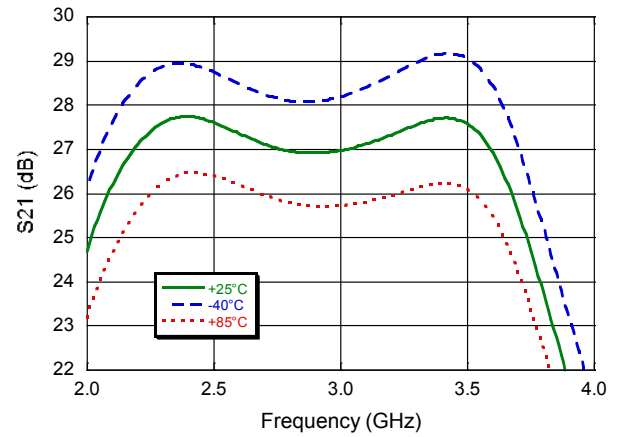

### Output Power, Pin = 19 dBm @ +25°C

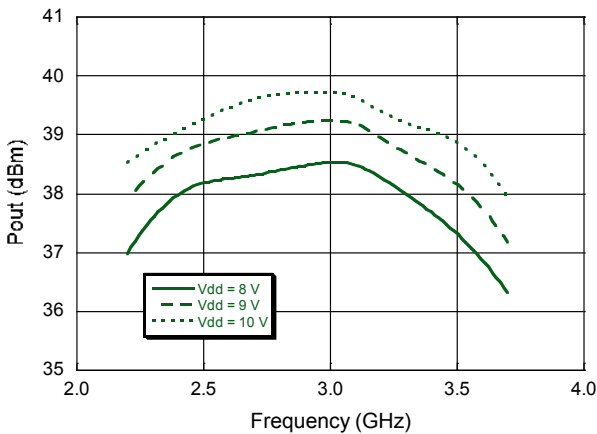

### Output Power, Pin = 19 dBm @ -40°C

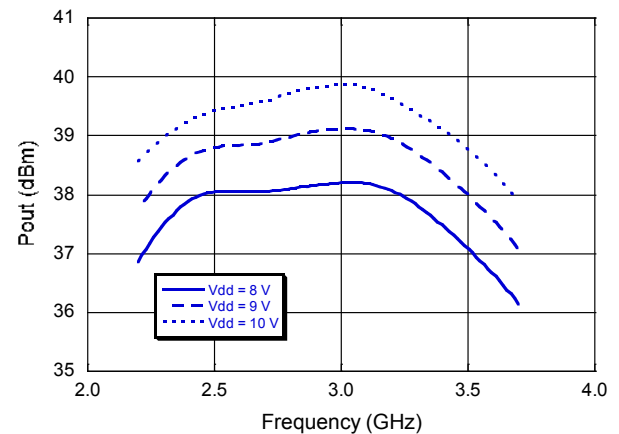

### Output Power, Pin = 19 dBm @ +85°C

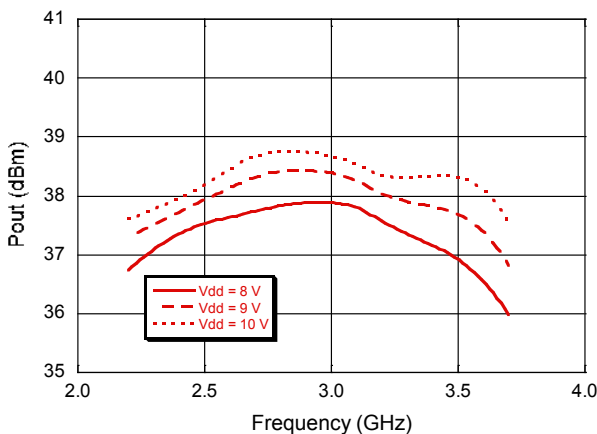

## Amplifier, Power, 8 W 2.5 - 3.5 GHz

Rev. V3

### Typical Performance Curves

Output Power @ 2.5 GHz

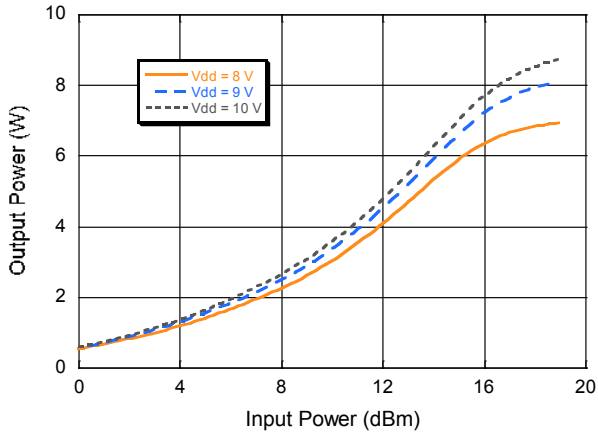

Output Power, V<sub>DD</sub> = 8 V

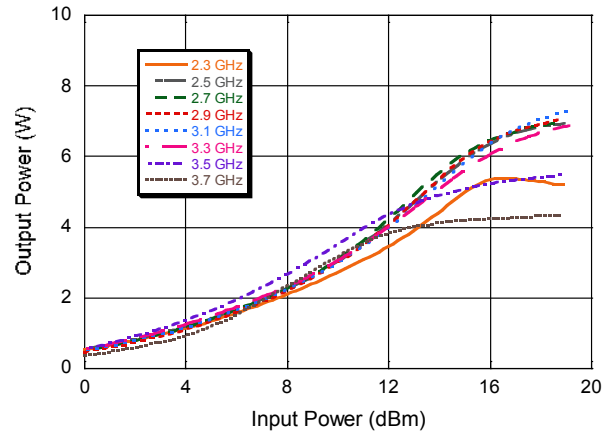

Output Power @ 3.1 GHz

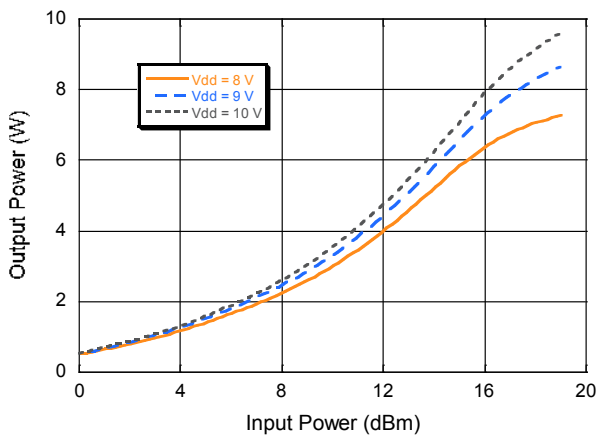

Output Power, V<sub>DD</sub> = 9 V

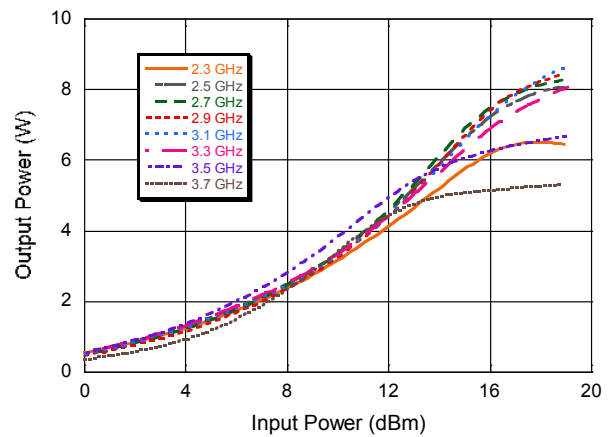

Output Power @ 3.5 GHz

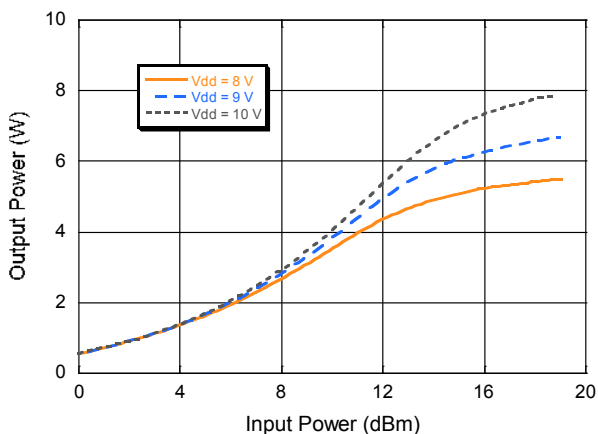

Output Power, V<sub>DD</sub> = 10 V

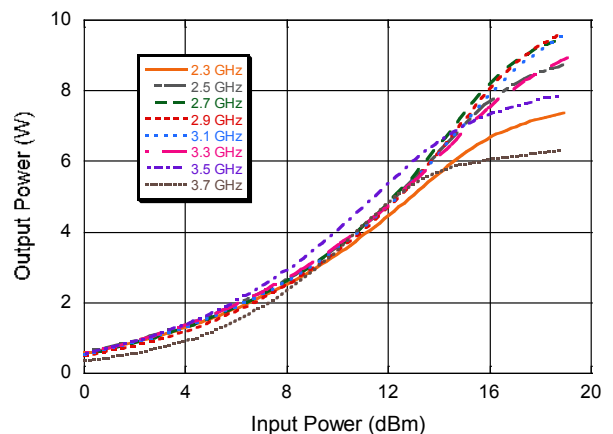

## Typical Performance Curves

### PAE

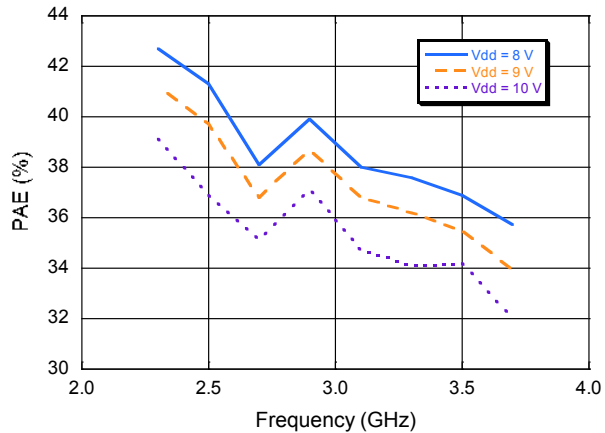

### 1st Stage Gate Current @ 2.9 GHz

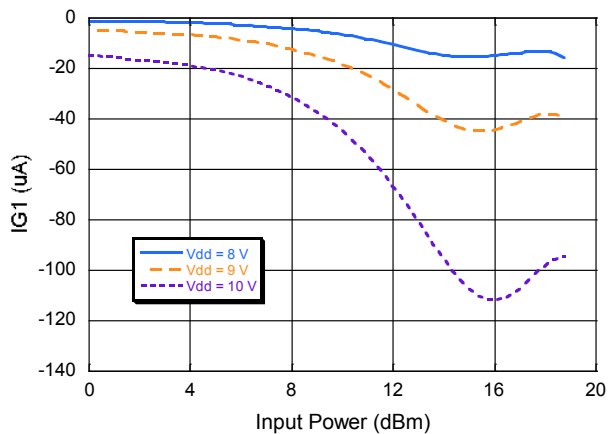

### 2nd Stage Gate Current @ 2.9 GHz

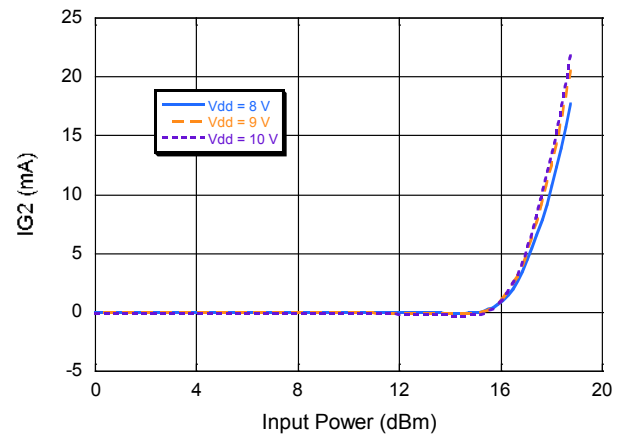

### Drain Current @ 2.9 GHz

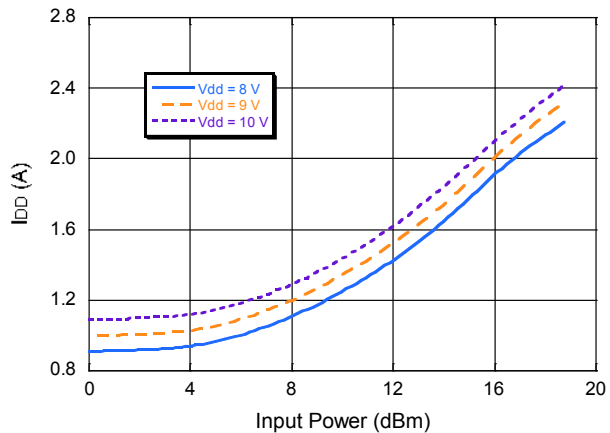

### Small Signal Drain Current @ 2.9 GHz

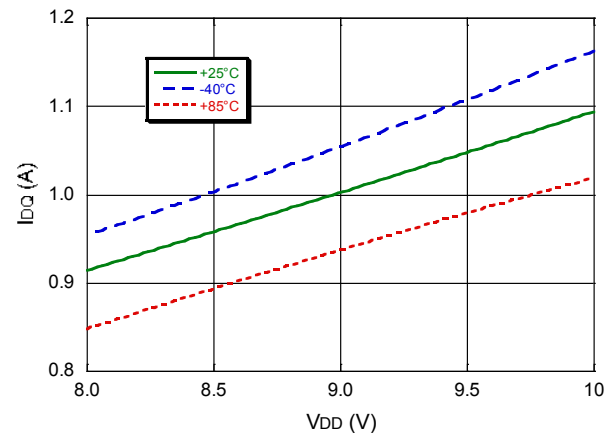

## Lead-Free 5 mm 20-Lead PQFN†

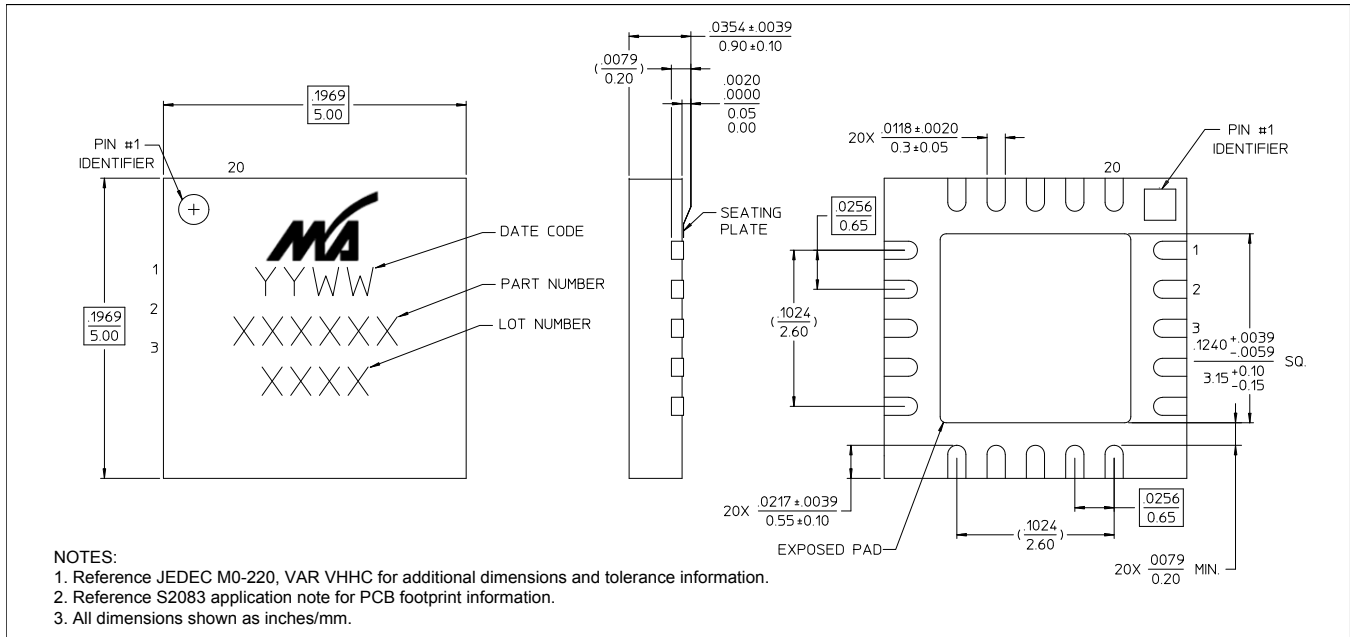

† Reference Application Note S2083 for lead-free solder reflow recommendations.  
Meets JEDEC moisture sensitivity level 1 requirements.  
Plating is 100% matte tin over copper.