

4 W Power Amplifier 7.1 - 7.9 GHz

Rev. V1

Features

- 22.0 dB Small Signal Gain
- 46.5 dBm Third Order Intercept Point (OIP3)
- >36.5 dBm Saturated Output Power (P_{SAT})
- Bias 2000 mA at 8 V
- Lead-Free 7mm Copper Coin Air Cavity Package
- RoHS* Compliant

Description

The MAAP-011161 is a packaged linear power amplifier that operates from 7.1 - 7.9 GHz. The device provides 22 dB gain and 46.5 dBm Output Third Order Intercept Point (OIP3) with >35.5 dBm saturated output power (P_{SAT}).

The packaged amplifier comes in an air cavity 7 mm surface mount package with a copper coin paddle and is comprised of a two stage power amplifier MMIC. The device includes on-chip ESD protection structures and DC by-pass capacitors to ease the implementation and volume assembly of the packaged part.

The device is specifically designed for use in 7 GHz point-to-point radios for cellular backhaul applications.

Ordering Information¹

Part Number	Package
MAAP-011161	Bulk Quantity
MAAP-011161-TR0500	500 Piece Reel
MAAP-011161-001SMB	Sample Board

1. Reference Application Note M513 for reel size information.

Functional Schematic

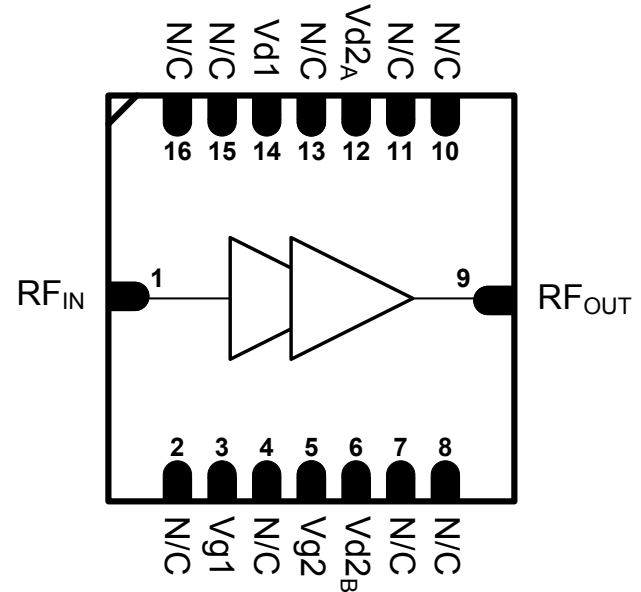

Pin Configuration³

Pin No.	Function	Pin No.	Function
1	RF Input	9	RF Output
2	No Connection	10	No Connection
3	Gate Stg1 Bias	11	No Connection
4	No Connection	12 ²	Drain Stg2 Bias
5	Gate Stg2 Bias	13	No Connection
6 ²	Drain Stg2 Bias	14	Drain Stg1 Bias
7	No Connection	15	No Connection
8	No Connection	16	No Connection

2. Drain 2 Bias can be connected from either pins 6 or 12

3. The exposed pad centered on the package bottom must be connected to RF and DC ground.

* Restrictions on Hazardous Substances, European Union Directive 2011/65/EU.

4 W Power Amplifier 7.1 - 7.9 GHz

Rev. V1

Electrical Specifications: Freq. = 7.1 - 7.9 GHz, $V_D = 8\text{ V}$, $I_{DQ}^4 = 2000\text{ mA}$, $T_A = +25^\circ\text{C}$

Parameter	Units	Min.	Typ.	Max.
Small Signal Gain	dB	18.5	22	23.5
Input Return Loss	dB	—	12	—
Output Return Loss	dB	7	12	—
Power at 1dB Gain Compression, P1dB	dB	—	35.5	—
Power at 3dB Gain Compression, P3dB	dBm	—	36	—
Saturated Output Power, P_{SAT}	dBm	35.5	36.5	—
Output IP3, 25.5 dBm SCL @ Freq = 7.5 GHz	dBm	44.5	46.5	—
Drain Bias voltage	V	—	8.0	—
Drain Current	mA	—	2000	—
Gate Voltage	V	-1.5	—	-0.5

4. Adjust V_{G1} and V_{G2} between -1.2 and -0.7V to achieve specified I_{DQ} ($I_{DQ} = I_{D1} + I_{D2}$). V_{G1} and V_{G2} should be the same voltage.

Absolute Maximum Ratings^{5,6,7}

Parameter	Absolute Max.
Input Power	18 dBm
Drain Voltage (V_D ,1,2)	+9 V
Gate Voltage (V_G ,1,2)	-3 V
Continuous Power Dissipation @ 85°C	33.3 W
Junction Temperature (max.)	+175°C
Junction Temperature	+150°C
Operating Temperature	-40°C to +85°C
Storage Temperature	-65°C to +150°C

- Exceeding any one or combination of these limits may cause permanent damage to this device.
- MACOM does not recommend sustained operation near these survivability limits.
- Operating at nominal conditions with $T_j \leq 150^\circ\text{C}$ will ensure $MTTF > 1 \times 10^6$ hours. Channel temperature should be kept as low as possible to maximize lifetime.

Handling Procedures

Please observe the following precautions to avoid damage:

Static Sensitivity

Gallium Arsenide Integrated Circuits are sensitive to electrostatic discharge (ESD) and can be damaged by static electricity. Proper ESD control techniques should be used when handling these Class 1A HBM devices.

Recommended PCB Layout

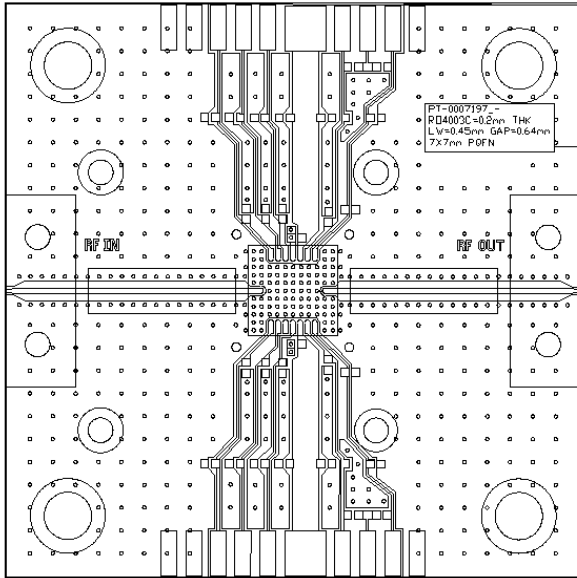

Schematic

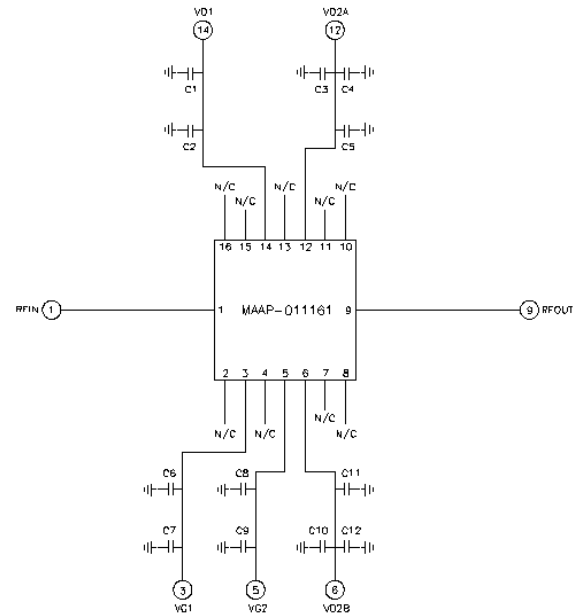

Parts List

Component	Value	Package
C1, C4, C7, C9, C12	2.2 μ F	0603
C3, C10	0.47 μ F	0603
C2, C5, C6, C8, C11	1.0 nF	0603

4 W Power Amplifier 7.1 - 7.9 GHz

Rev. V1

Typical Performance Curves: $V_D = 8\text{ V}$, $I_{DQ} = 2\text{ A}$, $V_G = -1.05 \sim -0.95\text{ V}$, $T_A = +25^\circ\text{C}$

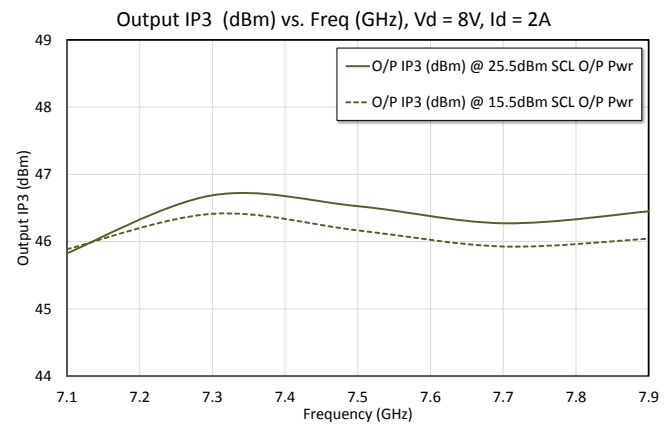
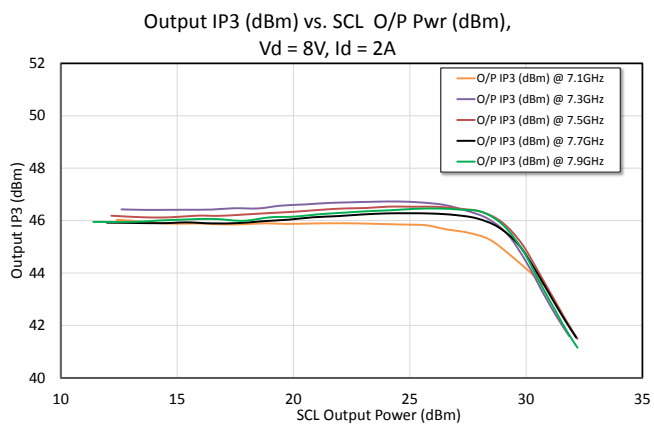
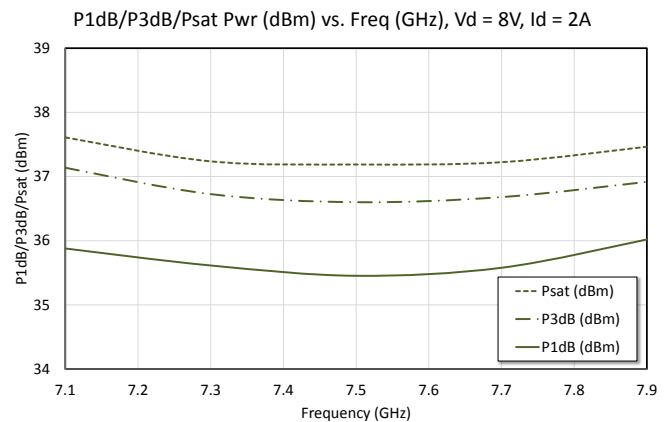
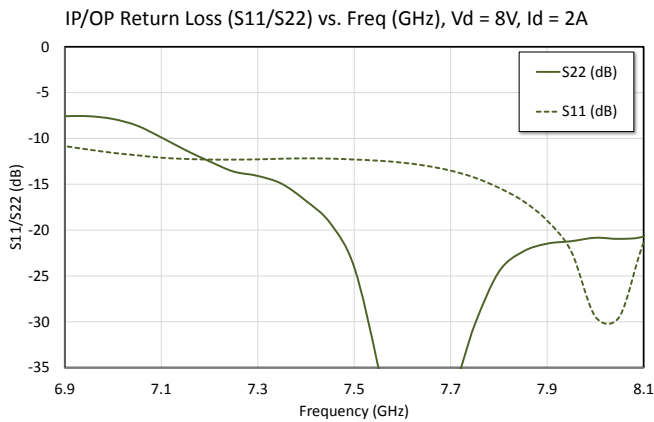
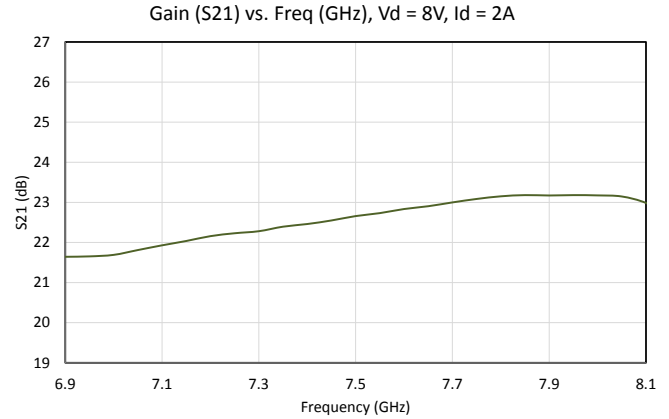
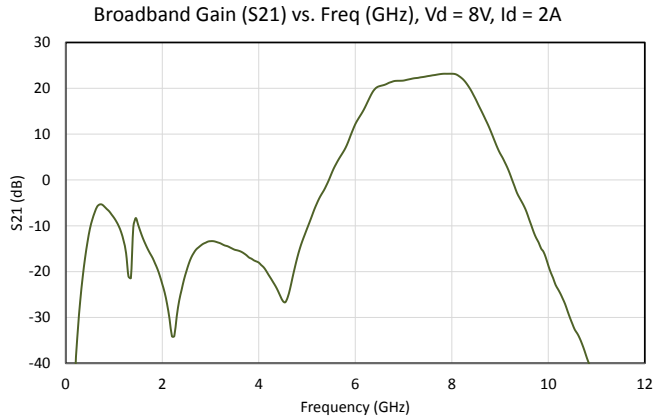

4 W Power Amplifier 7.1 - 7.9 GHz

Rev. V1

Typical Performance Curves: $V_D = 8\text{ V}$, $I_{DQ} = 2\text{ A}$, $V_G = -1.05 \sim -0.95\text{ V}$, $T_A = +25^\circ\text{C}$

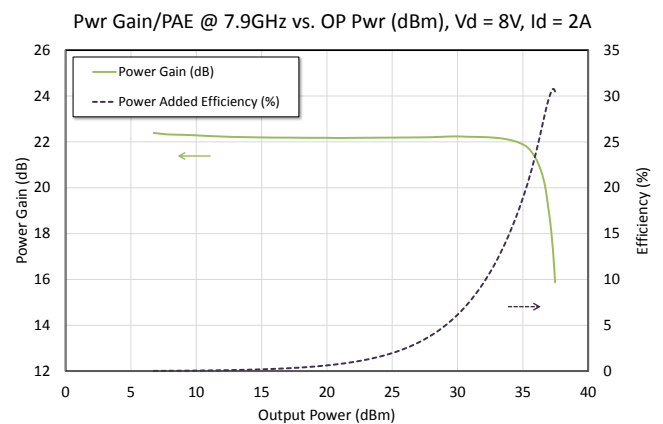
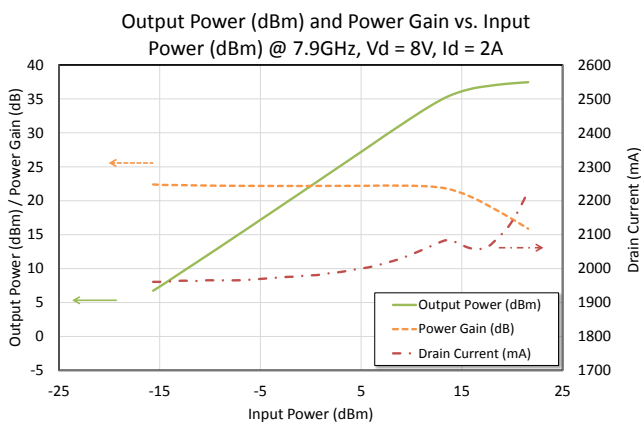
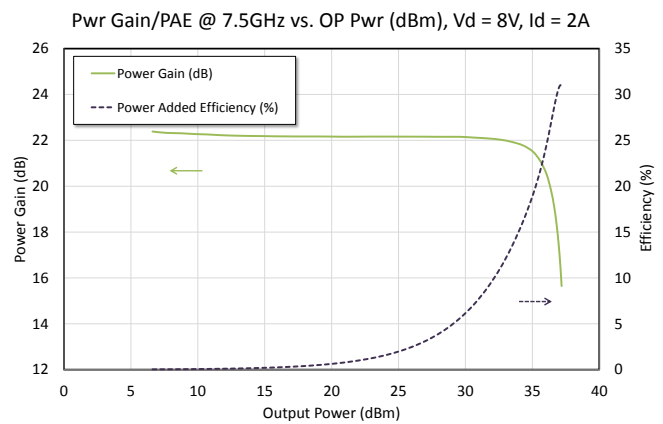
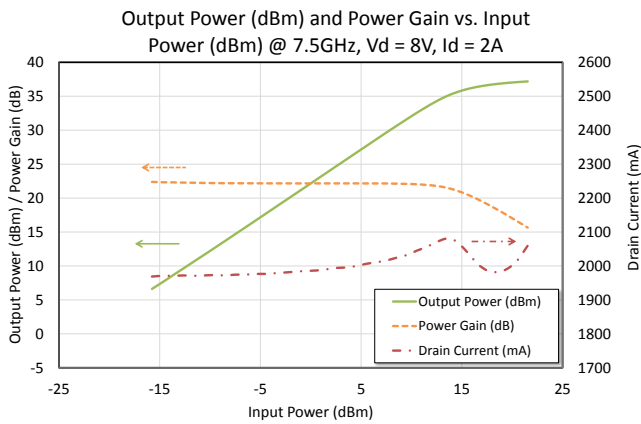
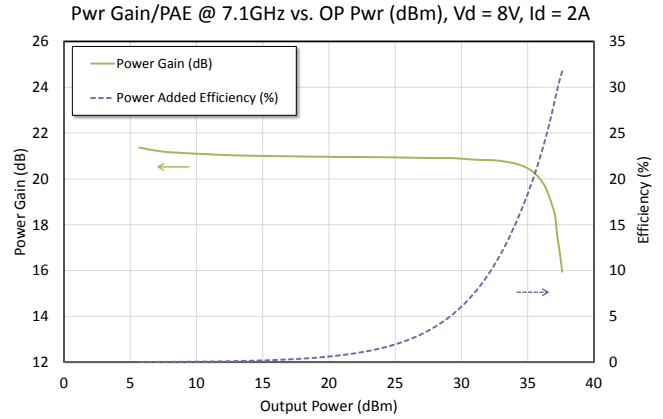
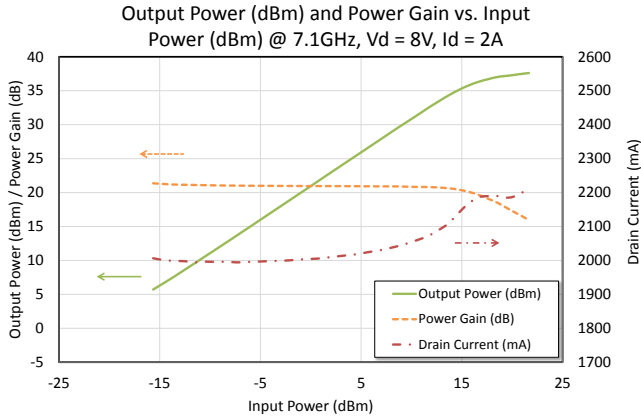

4 W Power Amplifier 7.1 - 7.9 GHz

Rev. V1

Typical Performance Curves: $V_D = 8\text{ V}$, $I_{DQ} = 2\text{ A}$, $V_G = -1.05 \sim -0.95\text{ V}$, $T_A = +25^\circ\text{C}$

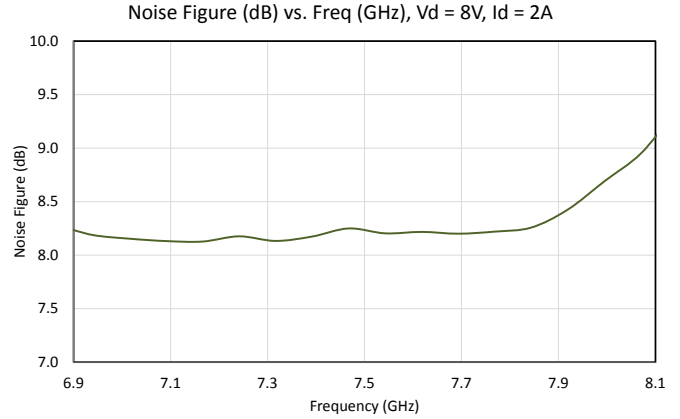
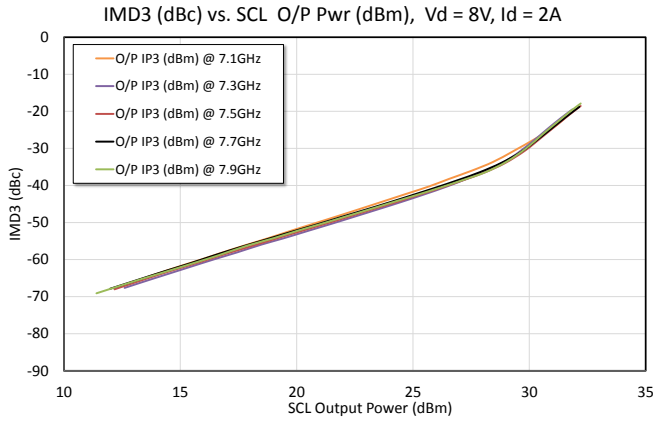

Typical Performance Curves: $V_D = 8\text{ V}$, $I_{DQ} = 2\text{ A}$, $V_G = -1.05 \sim -0.95\text{ V}$, $T_A = -40^\circ\text{C} \sim +85^\circ\text{C}$

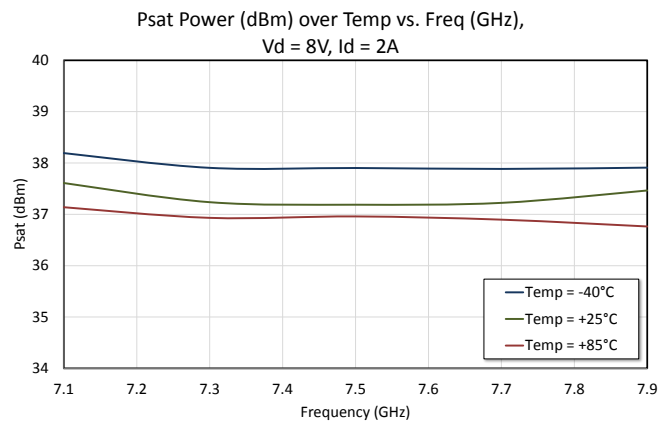
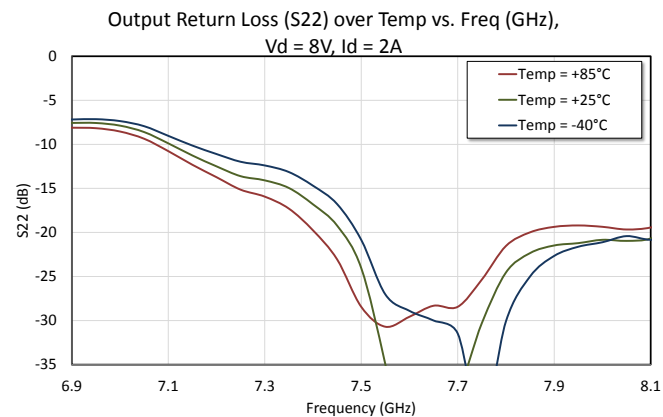
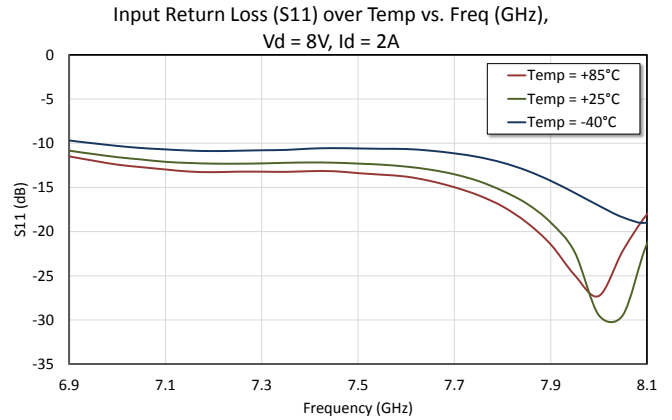
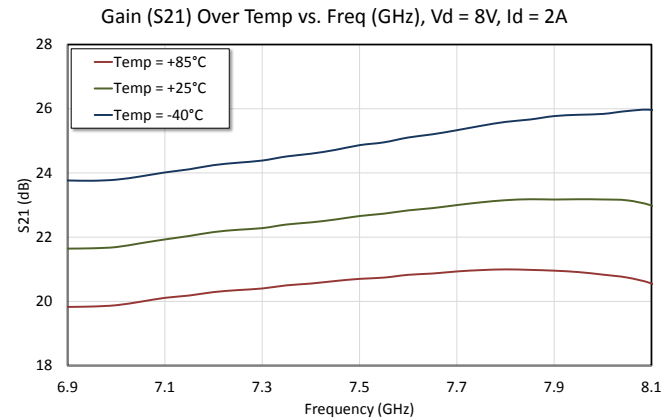

4 W Power Amplifier 7.1 - 7.9 GHz

Rev. V1

Typical Performance Curves: $V_D = 8\text{ V}$, $I_{DQ} = 2\text{ A}$, $V_G = -1.05 \sim -0.95\text{ V}$, $T_A = -40^\circ\text{C} \sim +85^\circ\text{C}$

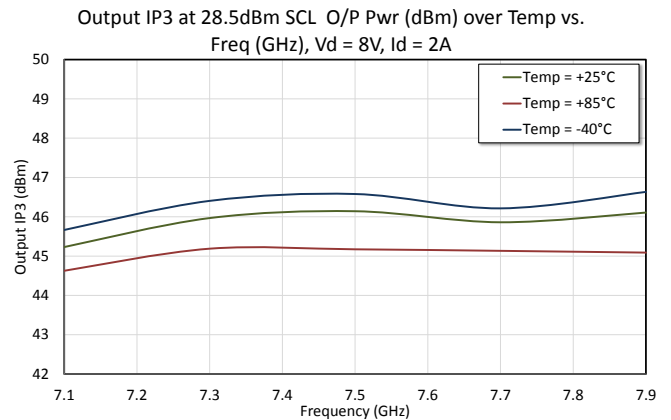
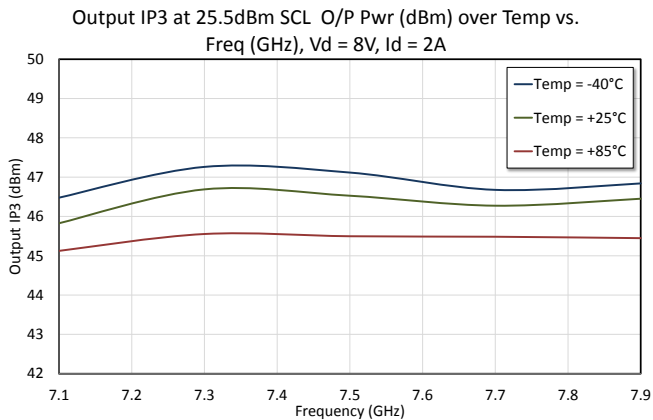
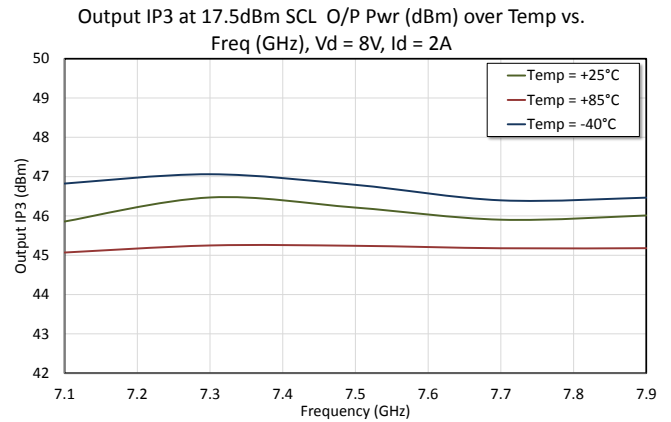
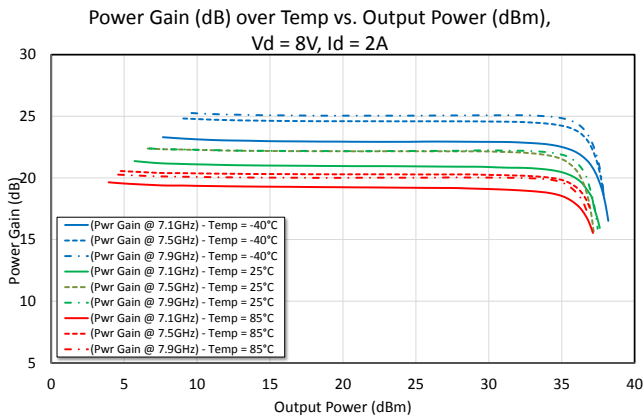
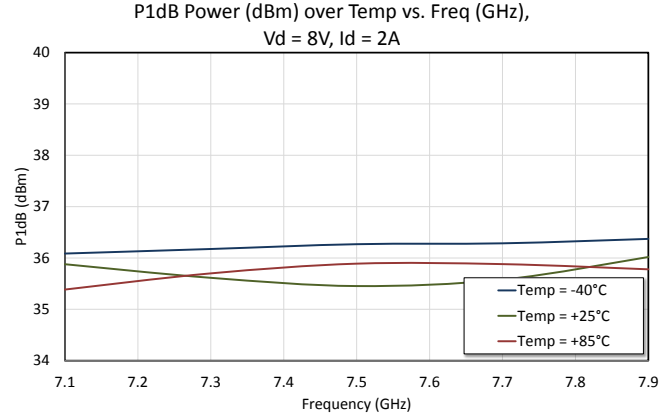
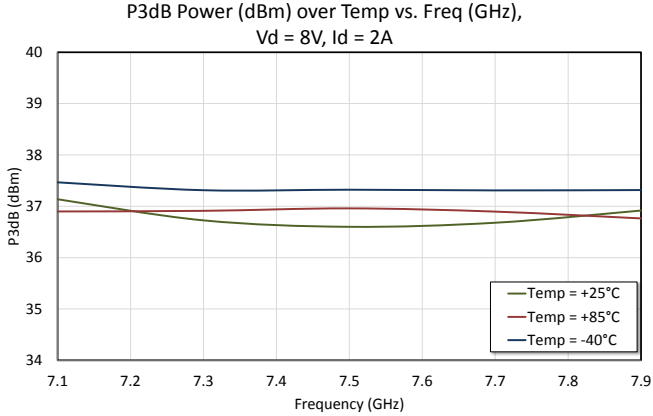

4 W Power Amplifier 7.1 - 7.9 GHz

Rev. V1

Typical Performance Curves: $V_D = \text{Various}$, $I_{DQ} = 2 \text{ A}$, $V_G = -1.05 \sim -0.95 \text{ V}$, $T_A = +25^\circ\text{C}$

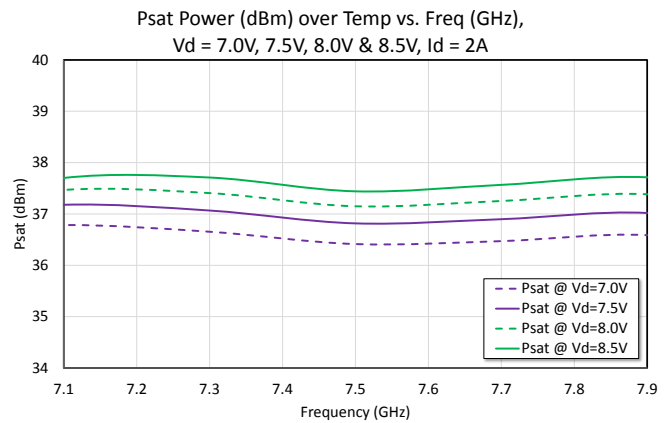
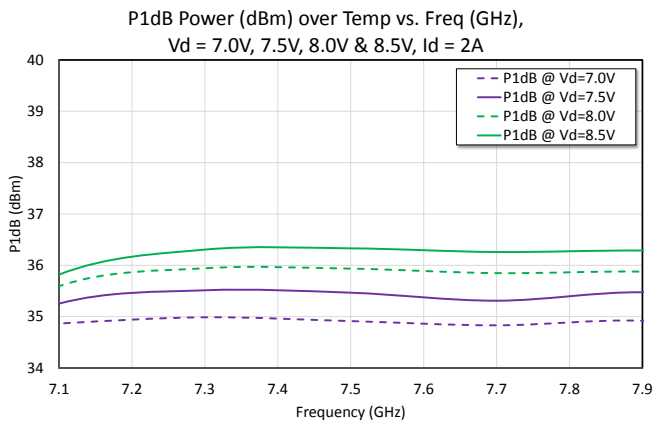
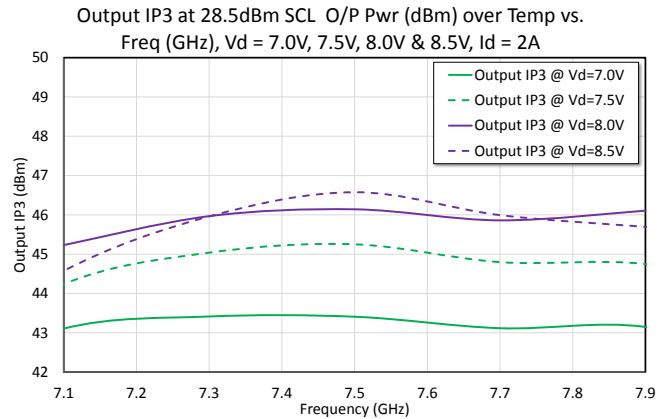
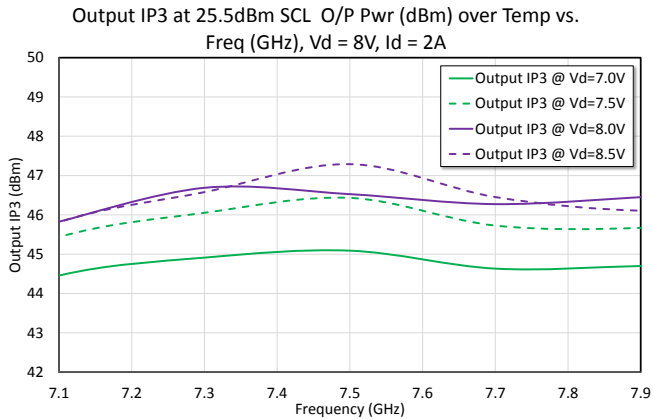

Typical Performance Curves:

$V_D = \text{Various}$, $I_{DQ} = 1.5 \text{ A}, 1.65 \text{ A}, 2.0 \text{ A}$, $V_G = -1.15 \sim -0.95 \text{ V}$, $T_A = +25^\circ\text{C}$

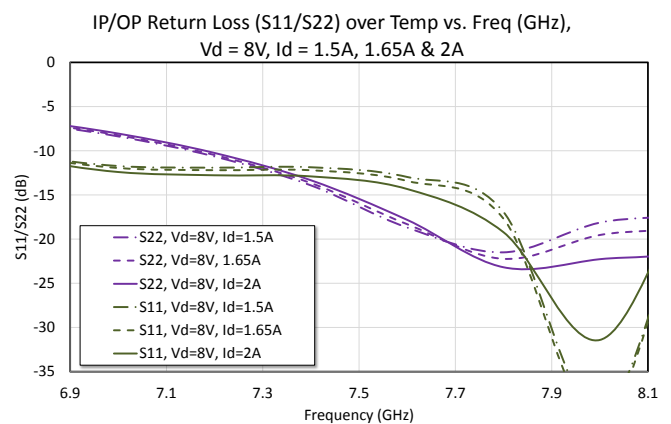
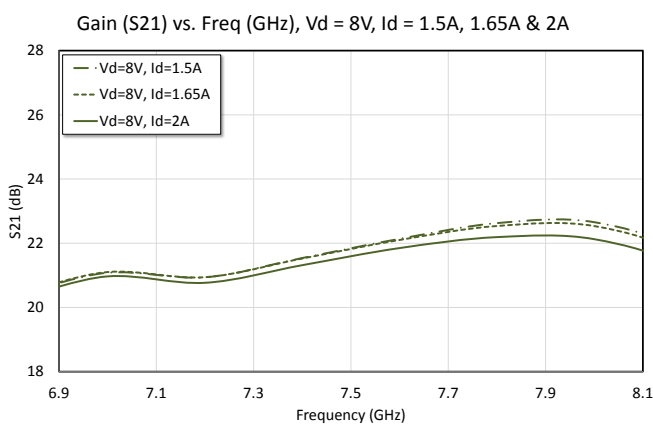

4 W Power Amplifier 7.1 - 7.9 GHz

Rev. V1

Typical Performance Curves:

$V_D = \text{Various}$, $I_{DQ} = 1.5 \text{ A}, 1.65 \text{ A}, 2.0 \text{ A}$, $V_G = -1.15 \sim -0.95 \text{ V}$, $T_A = +25^\circ\text{C}$

Output IP3 at 17.5dBm SCL O/P Pwr (dBm) vs. Freq (GHz),
 $V_d = 8\text{V}$, $I_d = 1.5\text{A}, 1.65\text{A} \ \& \ 2\text{A}$

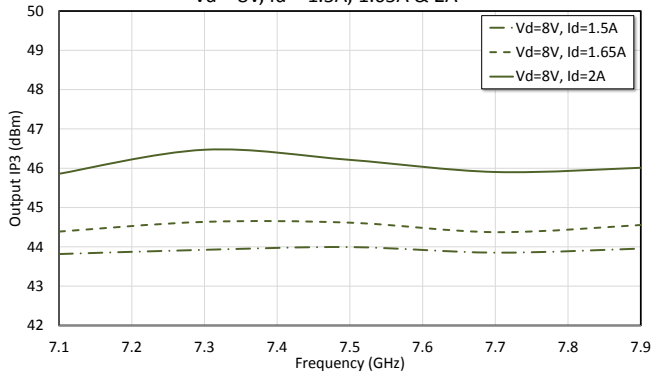

Output IP3 at 25.5dBm SCL O/P Pwr (dBm) vs. Freq (GHz),
 $V_d = 8\text{V}$, $I_d = 1.5\text{A}, 1.65\text{A} \ \& \ 2\text{A}$

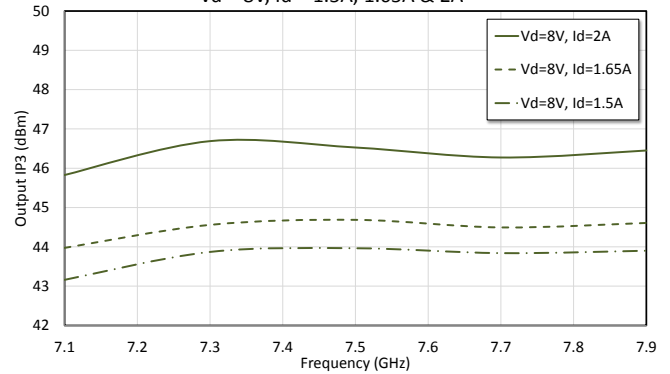

Output IP3 at 28.5dBm SCL O/P Pwr (dBm) vs. Freq (GHz),
 $V_d = 8\text{V}$, $I_d = 1.5\text{A}, 1.65\text{A} \ \& \ 2\text{A}$

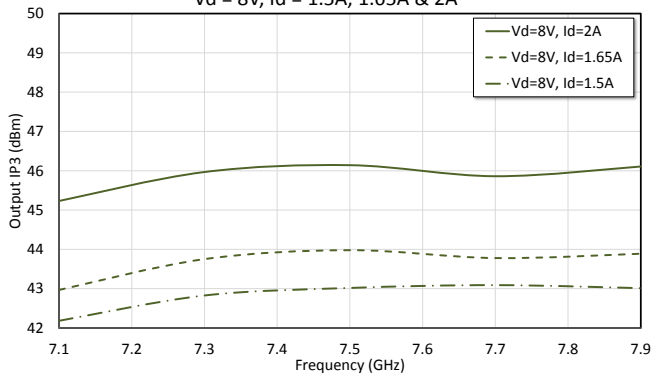

P1dB Power (dBm) vs. Freq (GHz),
 $V_d = 8\text{V}$, $I_d = 1.5\text{A}, 1.65\text{A} \ \& \ 2\text{A}$

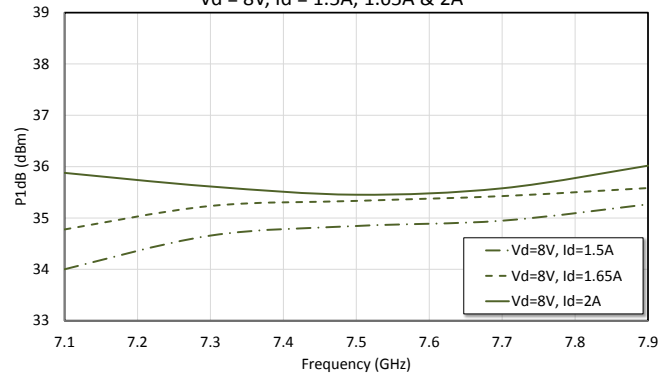

P3dB Power (dBm) vs. Freq (GHz),
 $V_d = 8\text{V}$, $I_d = 1.5\text{A}, 1.65\text{A} \ \& \ 2\text{A}$

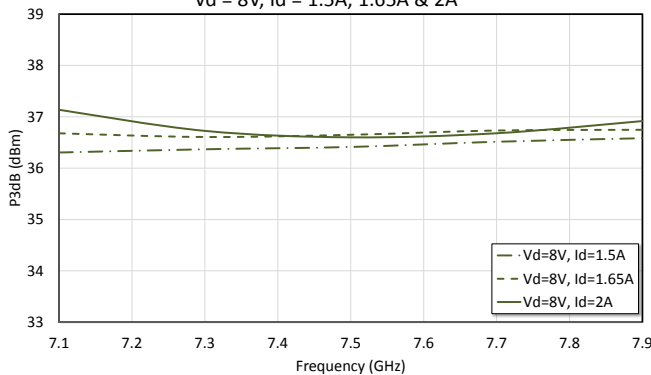

Psat Power (dBm) vs. Freq (GHz),
 $V_d = 8\text{V}$, $I_d = 1.5\text{A}, 1.65\text{A} \ \& \ 2\text{A}$

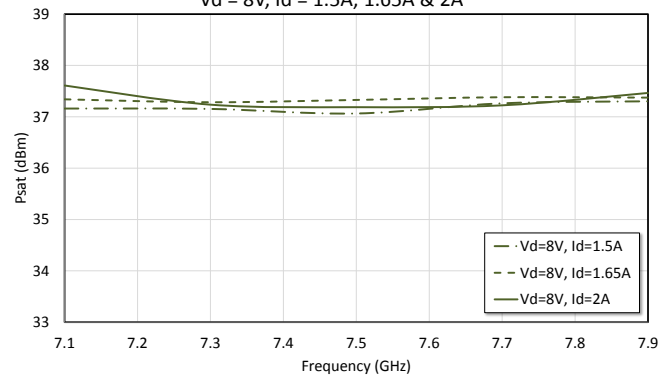

4 W Power Amplifier 7.1 - 7.9 GHz

Rev. V1

Typical Performance Curves: $V_D = 8\text{ V}$, $I_{DQ} = \text{Various}$, $V_G = -0.9 \sim 1.65\text{ V}$, $T_A = +25^\circ\text{C}$

