

RF 1:1 Flux Coupled Transformer 0.3 - 200 MHz

Rev. V9

Features

- Surface Mount
- 1:1 impedance
- Available on Tape and Reel
- RoHS Compliant and Lead free
- 260°C Reflow Compatible

Description

MABAES0060 is a RoHS compliant device that is equivalent to the ETC1-1T transformer. This device is a 1:1 RF flux coupled transformer in a SM-22 surface mount package and is designed to be utilized in both standard reflow and high temperature soldering

Ideally suited for high volume cellular and wireless applications. Typical applications include single to balanced mode conversion and impedance matching.

Functional Schematic

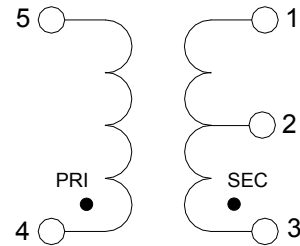

Pin Configuration²

Pin #	Function	Pin #	Function
1	Secondary	4	Primary dot
2	Secondary CT	5	Primary
3	Secondary Dot		

2. MACOM recommends connecting unused package pins to ground.

Electrical Specifications: Freq. = 0.3 - 200 MHz, T_A = 25°C, P_{in} = 0 dBm

Parameter	Test Conditions & Frequency (MHz)	Units	Min.	Typ.	Max.
Z₀ = 50 Ω					
Insertion Loss	0.3 - 200	dB	—	—	1.5
Amplitude Balance	0.3 - 50	dB	—	—	0.1
	0.3 - 200				0.5
Phase Balance	0.3 - 50	Degree	—	—	1.0
	0.3 - 200				5.0
Input Return Loss	0.3 - 200 5 - 120	dB	—	—	10.0 15.0
Z₀ = 75 Ω					
Insertion Loss	0.3 - 5	dB	—	—	1.7
	5 - 200				0.9
Amplitude Balance	0.3 - 50	dB	—	—	0.1
	0.3 - 200				0.5
Phase Balance	0.3 - 50	Degree	—	—	2.0
	0.3 - 200				5.0
Input Return Loss	0.3 - 5	dB	7	—	—
	5 - 120		19		
	120 - 200		15		

Ordering Information¹

Part Number	Package
MABAES0060	2000 piece reel

1. Reference Application Note M513 for reel size information.

1

MACOM Technology Solutions Inc. (MACOM) and its affiliates reserve the right to make changes to the product(s) or information contained herein without notice. Visit www.macom.com for additional data sheets and product information.

For further information and support please visit:
<https://www.macom.com/support>

Absolute Maximum Ratings^{1,2}

Parameter	Units
DC Power	500 mW
DC Current	500 mA
Operating Temperature	-40°C to +85°C

1. Exceeding any one or combination of these limits may cause permanent damage to this device.
2. The maximum DC current applies to the secondary center tap in applications where the secondary is balanced.

Application Schematic

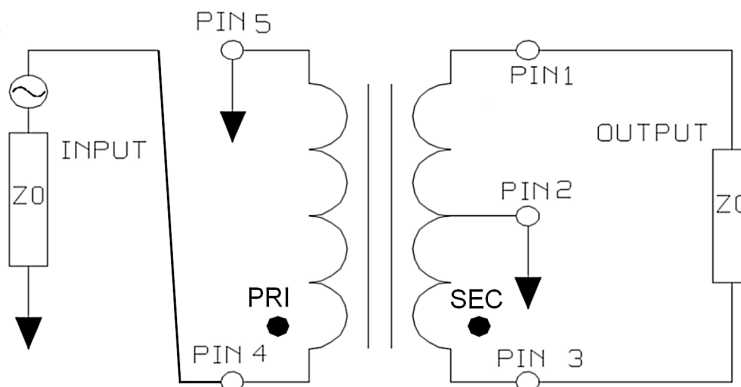

Typical Performance Curves: Freq. = 0.3 - 200 MHz, $T_A = 25^\circ\text{C}$, $Z_0 = 50 \Omega$, $P_{IN} = 0 \text{ dBm}$

Insertion Loss

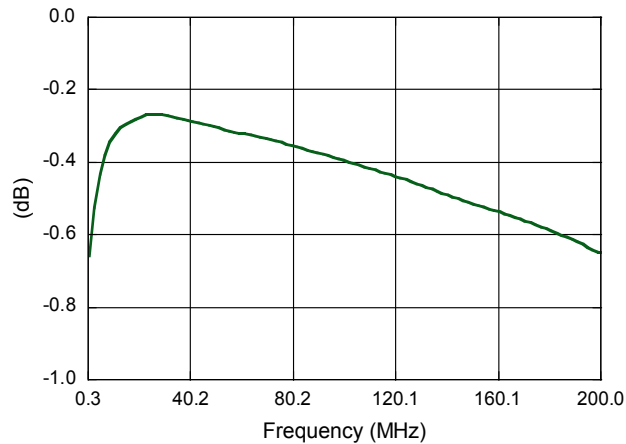

Input Return Loss

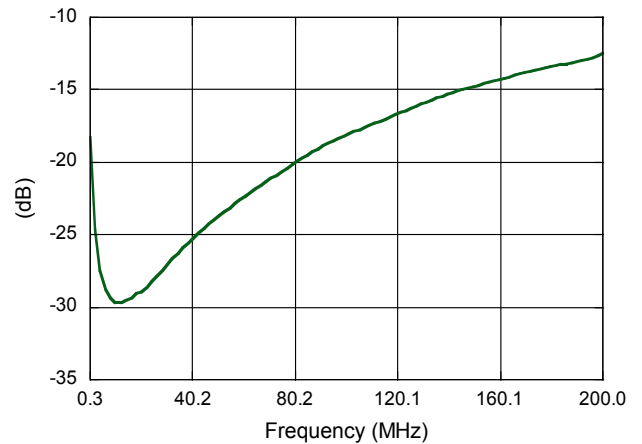

Amplitude Balance

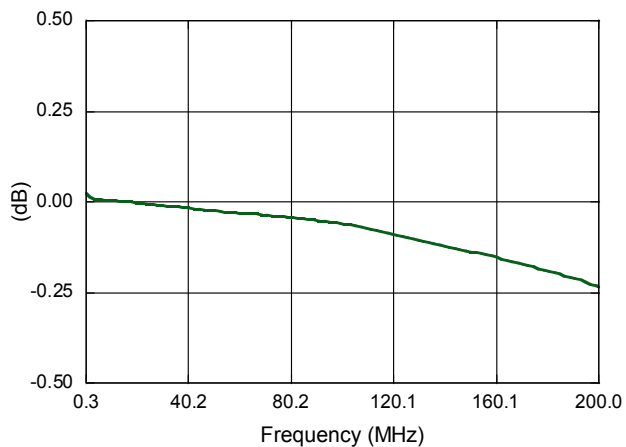

Phase Balance

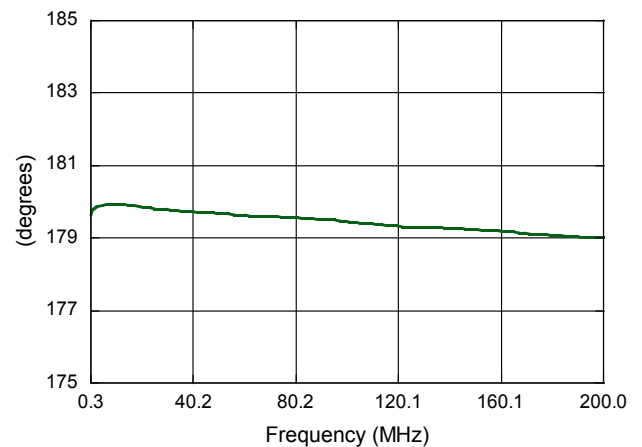

Typical Performance Curves: Freq. = 0.3 - 200 MHz, $T_A = 25^\circ\text{C}$, $Z_0 = 75 \Omega$, $P_{IN} = 0 \text{ dBm}$

Insertion Loss (pin 4_3)

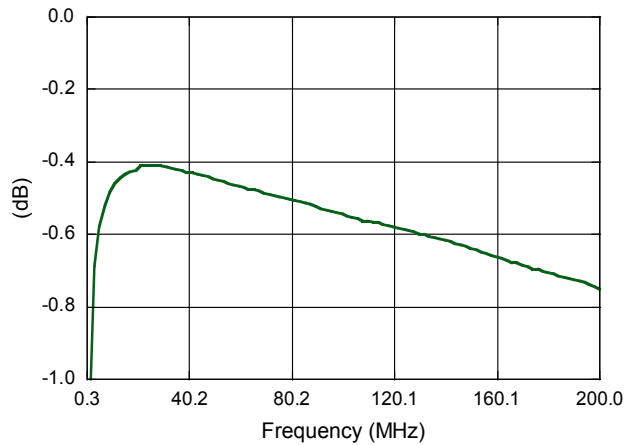

Insertion Loss (pin 4_1)

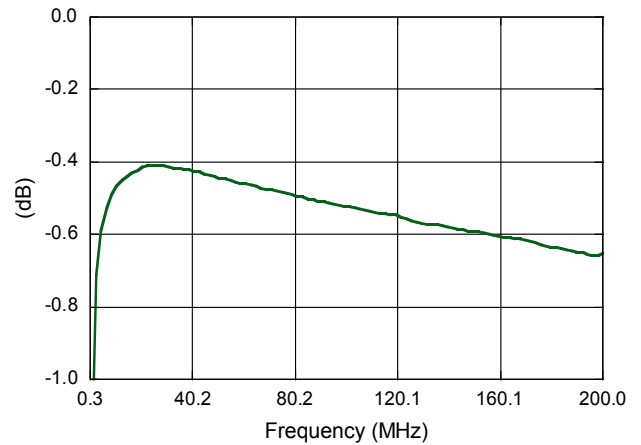

Amplitude Balance

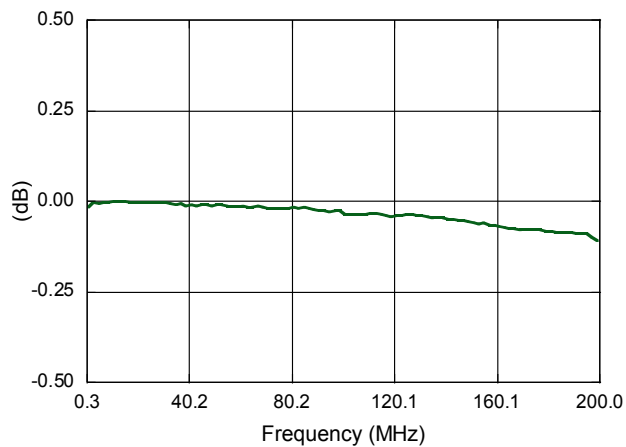

Phase Balance

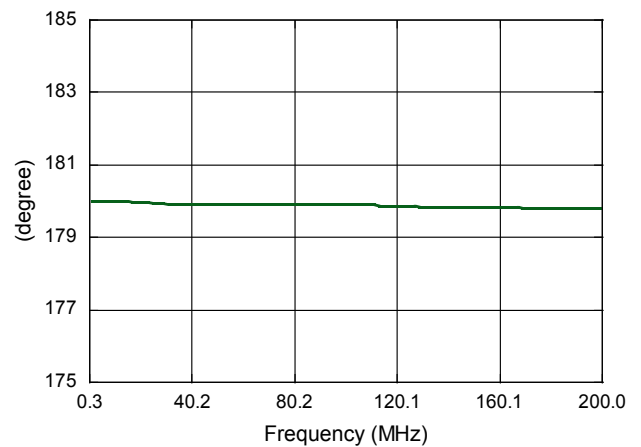

Outline Drawing

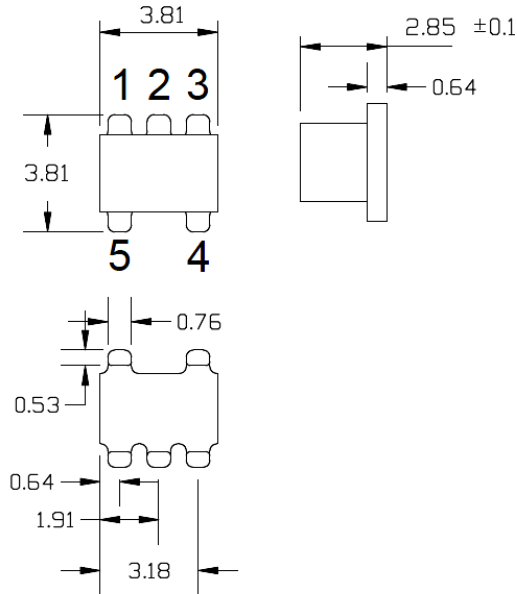

PCB Layout

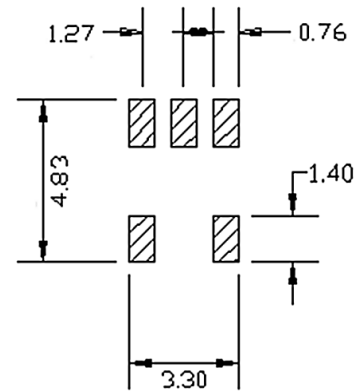

Dimensions in mm.
 Tolerance: ± 0.38 mm unless otherwise noted.
 Model number and lot code are printed on the reel.
 Lead plating: ENIG on both sides, 0.05 to 0.1 μ m gold over 3 to 6 μ m nickel.

Carrier Tape Orientation

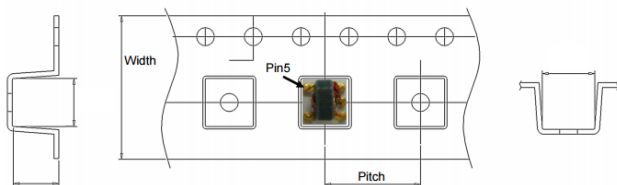

Tape & Reel Information

Parameter	Units	Value
Qty per reel	-	2000
Reel Size	mm	330
Tape Width	mm	12
Pitch	mm	8
Orientation	-	F5
Reference Application Note ANI-019 for orientation		