

PIN Diode Limiter 50 MHz - 4 GHz

Rev. V2

Features

- Low Insertion Loss and Noise Figure
- +40 dBm Peak and +30 dBm CW Power
- +10 dBm P1dB Compression Point
- +16 dBm Flat Leakage
- Lead-Free 1.2 x 1.5 mm 6-Lead PQFN Package
- RoHS Compliant* and 260°C Reflow Compatible

Description

The MADL-011008 is a silicon PIN limiter with small I-region length specifically designed for medium signal applications. The limiter is available in a lead-free 1.2 x 1.5 mm 6-lead PQFN package. The limiter is ideally designed to provide low insertion loss, at zero bias, as well as low flat leakage power with fast signal response/recovery times.

The MADL-011008 PIN limiter is designed for use in passive limiter control circuits to protect sensitive receiver components such as low noise amplifiers (LNA), detectors, and mixers.

Ordering Information^{1,2}

Part Number	Package
MADL-011008-141200	Bulk Packaging
MADL-011008-14120T	Tape and Reel
MADL-011008-001SMB	Sample Test Board

1. Reference Application Note M513 for reel size information.
2. All sample boards include 5 loose pieces.

Functional Schematic

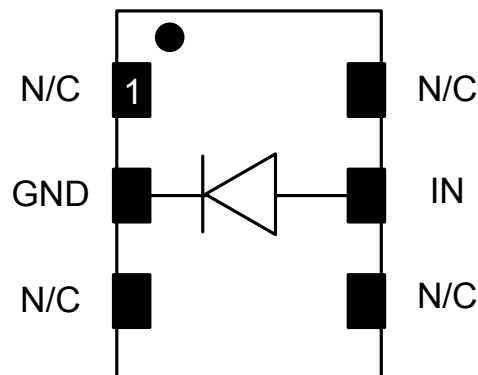

Pin Configuration

Pin No.	Pin Name	Description
1	N/C	No Connection
2	GND	RF Ground
3	N/C	No Connection
4	N/C	No Connection
5	IN	RF Input
6	N/C	No Connection
7 ³	Pad	GND

3. The exposed pad centered on the package bottom must be connected to RF and DC ground.

Handling Procedures

Please observe the following precautions to avoid damage:

Static Sensitivity

Silicon Integrated Circuits are sensitive to electrostatic discharge (ESD) and can be damaged by static electricity. Proper ESD control techniques should be used when handling these devices.

* Restrictions on Hazardous Substances, European Union Directive 2002/95/EC.

PIN Diode Limiter 50 MHz - 4 GHz

Rev. V2

Electrical Specifications: Freq 2.7 to 3.0 GHz, $T_A = 25^\circ\text{C}$, $Z_0 = 50 \Omega$

Parameter	Test Conditions	Units	Min.	Typ.	Max.
Insertion Loss	0 dBm	dB	—	0.15	—
Input Return Loss	0 dBm	dB	—	20	—
Output Return Loss	0 dBm	dB	—	20	—
P1dB	—	dBm	—	10	—
Peak Incident Power	Pulse Width 1 μSec , Duty Cycle 0.1%	dBm	—	40	—
CW Incident Power	—	dBm	—	30	—
CW Flat Leakage	Incident Power = +24 dBm	dBm	—	16	—
Recovery Time	To within 1 dB of final insertion loss Peak Incident Power = +30 dBm Pulse Width 1 μSec , Duty Cycle 0.1%	ns	—	50	—
Spike Leakage	+30 dBm Pin, Pulse Width 1 μSec , Duty Cycle 0.1%	erg	—	0.5	—
IP3	Pin -5 dBm/tone, 10 MHz Spacing	dBm	—	30	—
IP2	Pin -5 dBm/tone	dBm	—	43	—
Forward Voltage	Forward current = 10 mA	V	—	0.9	1.1
Reverse Current	Reverse voltage = 20 volts	μA	—	0.1	100

Absolute Maximum Ratings^{4,5}

Parameter	Absolute Maximum
Peak Incident Power Pulse Width 1 μSec , Duty Cycle 0.1%	43 dBm
CW Incident Power	33 dBm
Operating Temperature	-40°C to $+85^\circ\text{C}$
Storage Temperature	-65°C to $+150^\circ\text{C}$

- Exceeding any one or combination of these limits may cause permanent damage to this device.
- M/A-COM Technology Solutions does not recommend sustained operation near these survivability limits.

Application Schematic

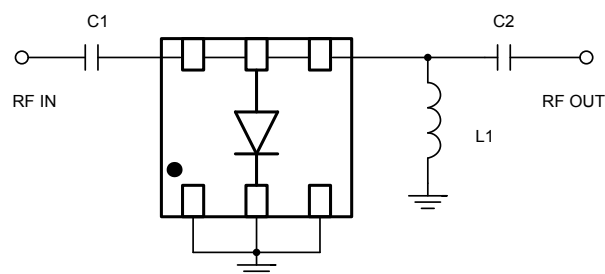

Recommended Board Layout

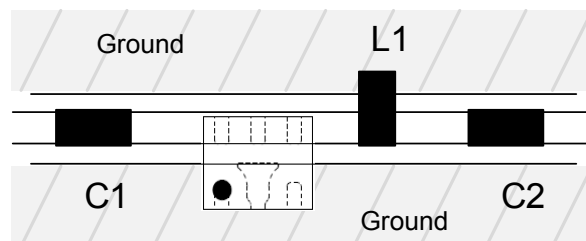

Parts List

Component	Value	Package
C1 - C2	68 pF	0402
L1	5.1 nH	0402

Typical Performance Curves

Insertion Loss

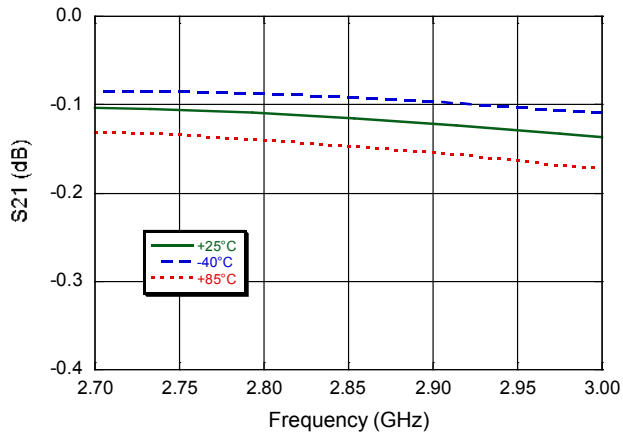

Pin vs. Pout @ 2.85 GHz

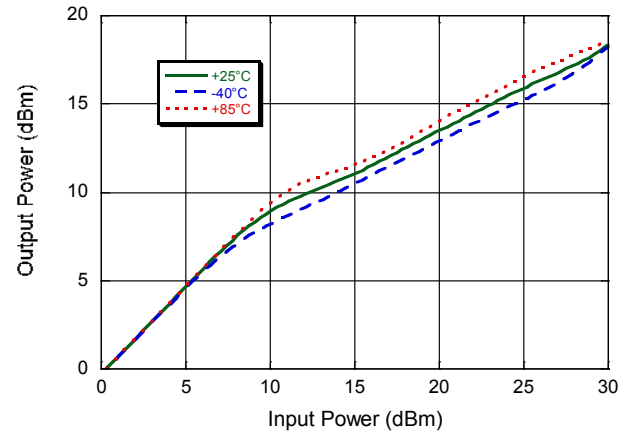

Input Return loss

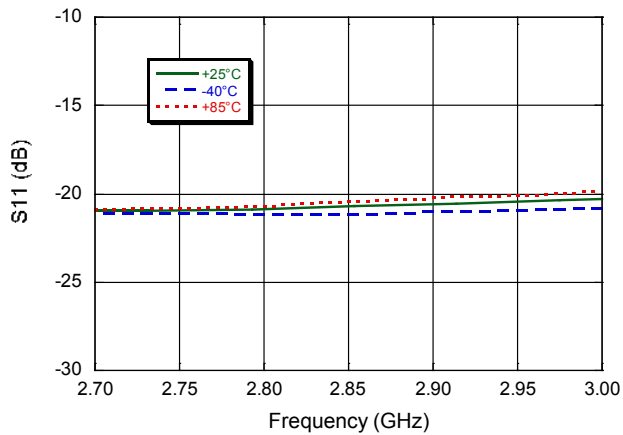

Output Return Loss

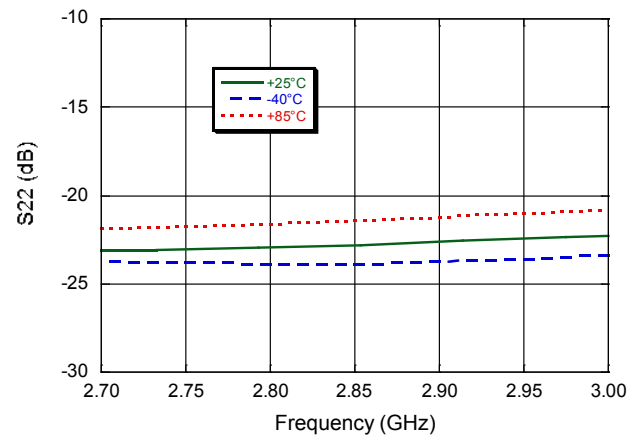

Lead-Free 1.2 x 1.5 mm 6-Lead PQFN[†]

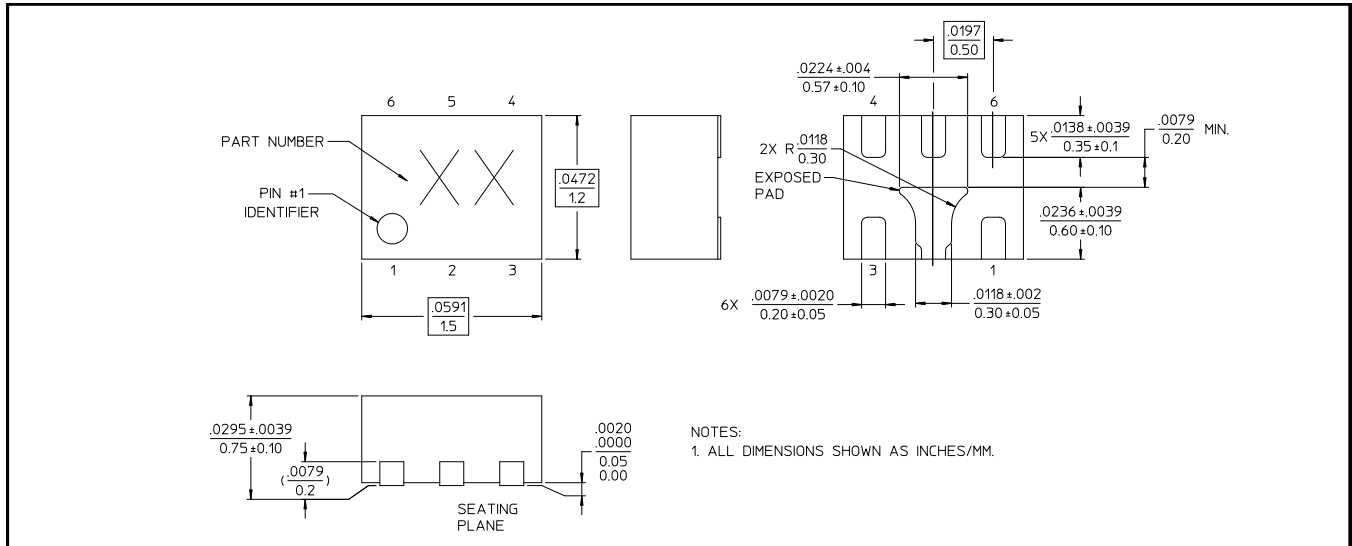

[†] Reference Application Note M538 for lead-free solder reflow recommendations.
 Meets JEDEC moisture sensitivity level 1 requirements.
 Plating is 100% matte tin over copper.