

GaN Amplifier 50 V, 300 W

2.4 - 2.5 GHz



MAGE-102425-300S00

Rev. V3

Features

- Optimized for RF Energy Applications
- Suitable for Linear and Saturated Applications
- CW and Pulsed Operation: 300 W Output Power
- Internally Pre-Matched
- 50 V Operation
- 100% RF Tested
- RoHS* Compliant



AC-780S-2

Description

The MAGE-102425-300S00 is a GaN HEMT D-mode amplifier designed for RF Energy applications and optimized for 2.4 - 2.5 GHz CW signal operation. This device supports CW and pulsed operation with peak output power levels to 300 W (54.8 dBm) in an air cavity ceramic package.

The MAGE-102425-300S00 is ideally suited for CW applications as a highly efficient precise heat and power source. The wide range of applications includes solid state cooking, RF plasma generation, material drying, industrial heating, automotive ignition, lighting and medical.

Typical Performance:

- $V_{DS} = 50 \text{ V}$, $I_{DQ} = 300 \text{ mA}$, $T_C = 25^\circ\text{C}$
Measured under pulsed load-pull at 2.5 dB compression, 100 μs pulse width, 10% duty cycle.

Frequency (GHz)	Gain ² (dB)	η_D^2 (%)	Output Power ¹ (dB)
2.45	16.7	75	55.6

1. Load impedance tuned for maximum output power.
2. Load impedance tuned for maximum drain efficiency.

Functional Schematic

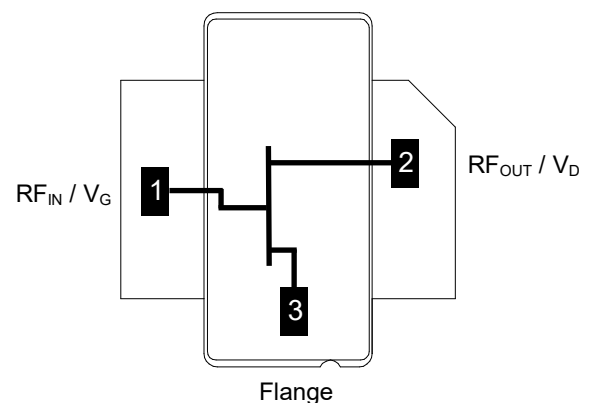

Pin Configuration

Pin #	Pin Name	Function
1	RF _{IN} / V _G	RF Input / Gate
2	RF _{OUT} / V _D	RF Output / Drain
3	Flange ³	Ground / Source

3. The flange on the package bottom must be connected to RF, DC and thermal ground.

Ordering Information

Part Number	Package
MAGE-102425-300S00	Bulk Quantity
MAGE-102425-300ST0	Tape and Reel
MAGE-1D2425-300S00	Sample Board

* Restrictions on Hazardous Substances, compliant to current RoHS EU directive.

GaN Amplifier 50 V, 300 W

2.4 - 2.5 GHz



MAGE-102425-300S00

Rev. V3

RF Electrical Characteristics: $T_C = +25^\circ\text{C}$, $V_{DS} = 50\text{ V}$, $I_{DQ} = 300\text{ mA}$
Note: Performance in MACOM Evaluation Test Fixture, 50 Ω system

Parameter	Test Conditions	Symbol	Min.	Typ.	Max.	Units
Small Signal Gain	Pulsed ⁴ , 2.45 GHz	G_{SS}	-	15.0	-	dB
Power Gain	CW, 2.45 GHz, 2 dB Gain Compression	G_{SAT}	-	14.0	-	dB
Saturated Drain Efficiency	CW, 2.45 GHz, 2 dB Gain Compression	η_{SAT}	-	65.0	-	%
Saturated Output Power	CW, 2.45 GHz, 2 dB Gain Compression	P_{SAT}	-	55.4	-	dBm
Gain Variation (-40°C to +85°C)	Pulsed ⁴ 2.45 GHz	ΔG	-	0.02	-	dB/°C
Power Variation (-40°C to +85°C)	Pulsed ⁴ 2.45 GHz	ΔP_{2dB}	-	0.02	-	dB/°C
Gain	Pulsed ⁴ , 2.45 GHz, $P_{OUT} = 54.8\text{ dBm}$	G_P	-	15.0	-	dB
Drain Efficiency	Pulsed ⁴ , 2.45 GHz, $P_{OUT} = 54.8\text{ dBm}$	η	-	62	-	%
Ruggedness: Output Mismatch	Pulsed ⁴ , 2.45 GHz, All phase angles	Ψ	VSWR = 10:1, No Damage			
Ruggedness: Output Mismatch	CW, 2.45 GHz, All phase angles	Ψ	VSWR = 3:1, No Damage			

RF Electrical Specifications: $T_A = +25^\circ\text{C}$, $V_{DS} = 50\text{ V}$, $I_{DQ} = 300\text{ mA}$
Note: Performance in MACOM Production Test Fixture, 50 Ω system

Parameter	Test Conditions	Symbol	Min.	Typ.	Max.	Units
Power Gain	Pulsed ⁴ , 2.5 GHz, 2 dB Gain Compression	G_{SAT}	11.5	14.0	-	dB
Saturated Drain Efficiency	Pulsed ⁴ , 2.5 GHz, 2 dB Gain Compression	η_{SAT}	54.7	62.5	-	%
Saturated Output Power	Pulsed ⁴ , 2.5 GHz, 2 dB Gain Compression	P_{SAT}	53.5	54.7	-	dBm
Gain	Pulsed ⁴ , 2.5 GHz, $P_{IN} = 41\text{ dBm}$	G_P	11.2	13.7	-	dB
Drain Efficiency	Pulsed ⁴ , 2.5 GHz, $P_{IN} = 41\text{ dBm}$	η	55.1	62.8	-	%

4. Pulse details: 100 μs pulse width, 10% Duty Cycle.

DC Electrical Characteristics $T_A = +25^\circ\text{C}$

Parameter	Test Conditions	Symbol	Min.	Typ.	Max.	Units
Drain-Source Leakage Current	$V_{GS} = -8\text{ V}$, $V_{DS} = 130\text{ V}$	I_{DLK}	-	-	54	mA
Gate-Source Leakage Current	$V_{GS} = -8\text{ V}$, $V_{DS} = 0\text{ V}$	I_{GLK}	-	-	54	mA
Gate Threshold Voltage	$V_{DS} = 50\text{ V}$, $I_D = 54\text{ mA}$	V_T	-2.6	-2.1	-	V
Gate Quiescent Voltage	$V_{DS} = 50\text{ V}$, $I_D = 300\text{ mA}$	V_{GSQ}	-2.4	-2.0	-1.4	V
On Resistance	$V_{GS} = 2\text{ V}$, $I_D = 405\text{ mA}$	R_{ON}	-	0.12	-	W
Maximum Drain Current	$V_{DS} = 7\text{ V}$ pulsed, pulse width 300 μs	$I_{D, MAX}$	-	31.5	-	A

Absolute Maximum Ratings^{5,6,7,8,9}

Parameter	Absolute Maximum
Drain Source Voltage, V_{DS}	130 V
Gate Source Voltage, V_{GS}	-10 to 3 V
Gate Current, I_G	54 mA
Storage Temperature Range	-65°C to +150°C
Case Operating Temperature Range	-40°C to +85°C
Channel Operating Temperature Range, T_{CH}	-40°C to +225°C
Absolute Maximum Channel Temperature	+250°C

5. Exceeding any one or combination of these limits may cause permanent damage to this device.
6. MACOM does not recommend sustained operation above maximum operating conditions.
7. Operating at drain source voltage $V_{DS} < 55$ V will ensure $MTTF > 1 \times 10^7$ hours.
8. Operating at nominal conditions with $T_{CH} \leq 225^\circ\text{C}$ will ensure $MTTF > 1 \times 10^7$ hours.
9. $MTTF$ may be estimated by the expression $MTTF \text{ (hours)} = A e^{[B + C/(T+273)]}$ where T is the channel temperature in degrees Celsius, $A = 3.686$, $B = -35.00$, and $C = 25,416$.

Thermal Characteristics¹⁰

Parameter	Test Conditions	Symbol	Typical	Units
Thermal Resistance using Finite Element Analysis	$V_{DS} = 50$ V, $T_C = 85^\circ\text{C}, T_{CH} = 225^\circ\text{C}$	$R_{\theta}(\text{FEA})$	0.76	°C/W
Thermal Resistance using Infrared Measurement of Die Surface Temperature	$V_{DS} = 50$ V, $T_C = 85^\circ\text{C}, T_{CH} = 225^\circ\text{C}$	$R_{\theta}(\text{IR})$	0.64	°C/W

10. Case temperature measured using thermocouple embedded in heat-sink. Contact local applications support team for more details on this measurement.

Handling Procedures

Please observe the following precautions to avoid damage:

Static Sensitivity

Gallium Nitride Circuits are sensitive to electrostatic discharge (ESD) and can be damaged by static electricity. Proper ESD control techniques should be used when handling these HBM Class 1C, CDM Class C3 devices.

**Pulsed⁴ Load-Pull Performance
Reference Plane at Device Leads**

Frequency (GHz)	Z_{SOURCE} (Ω)	Maximum Output Power					
		$V_{DS} = 50 \text{ V}, I_{DQ} = 300 \text{ mA}, T_C = 25^\circ\text{C}, P_{2.5dB}$					
		Z_{LOAD}^{11} (Ω)	Gain (dB)	P_{OUT} (dBm)	P_{OUT} (W)	η_D (%)	AM/PM ($^\circ$)
2.40	1.3 - j4.8	1.3 - j3.3	15.2	55.8	380	70.0	53
2.45	2.0 - j5.0	1.5 - j3.2	16.0	55.6	371	72.8	45
2.50	2.0 - j5.6	1.0 - j3.5	15.2	55.8	380	69.0	41

Frequency (GHz)	Z_{SOURCE} (Ω)	Maximum Drain Efficiency					
		$V_{DS} = 50 \text{ V}, I_{DQ} = 300 \text{ mA}, T_C = 25^\circ\text{C}, P_{2.5dB}$					
		Z_{LOAD}^{12} (Ω)	Gain (dB)	P_{OUT} (dBm)	P_{OUT} (W)	η_D (%)	AM/PM ($^\circ$)
2.40	1.3 - j4.8	1.95 - j3.0	16.5	54.5	280	73	47
2.45	2.0 - j5.0	2.1 - j2.8	16.7	54.2	263	75	42
2.50	2.0 - j5.6	1.9 - j2.9	16.6	54.3	270	73	30

Impedance Reference

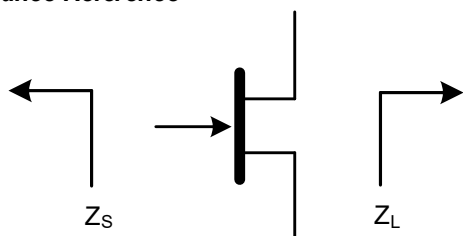

Z_{SOURCE} = Measured impedance presented to the input of the device at package reference plane.

Z_{LOAD} = Measured impedance presented to the output of the device at package reference plane.

- 11. Load Impedance for optimum output power.
- 12. Load Impedance for optimum efficiency.

Pulsed⁴ Load-Pull Performance @ 2.45 GHz

P2.5dB Loadpull Output Power Contours (dBm)

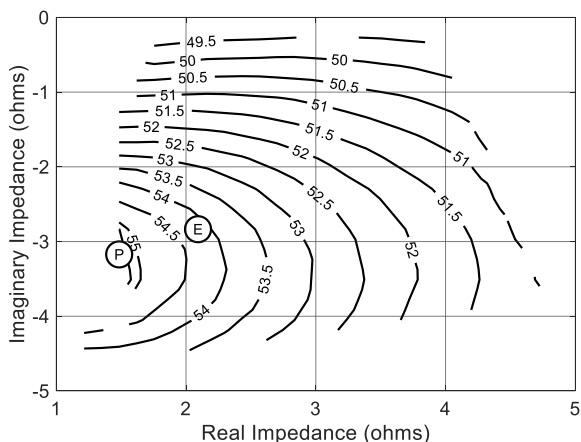

P2.5dB Loadpull Drain Efficiency Contours (%)

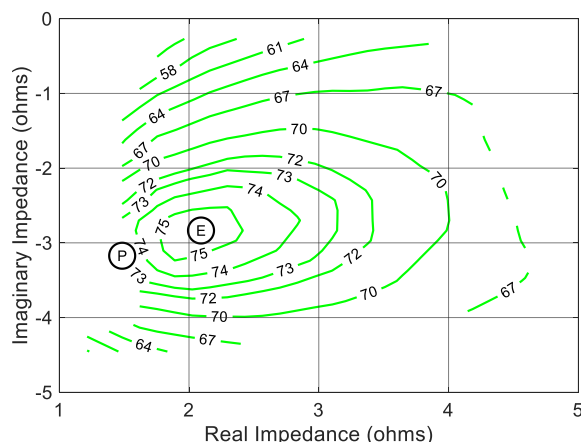

P2.5dB Loadpull Gain Contours (dB)

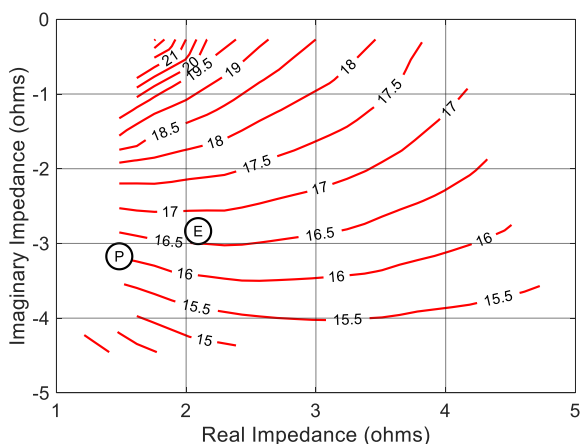

P2.5dB Loadpull AM/PM Contours (°)

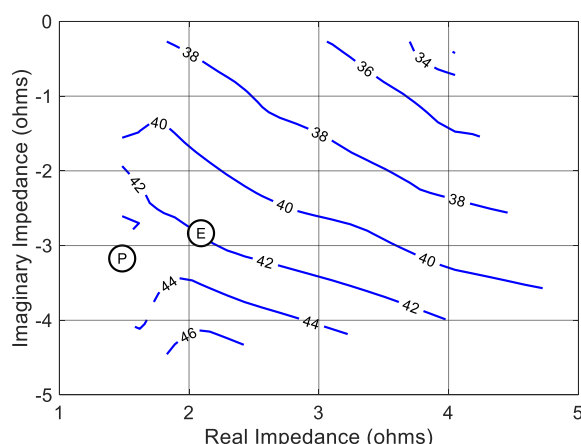

Gain vs. Output Power

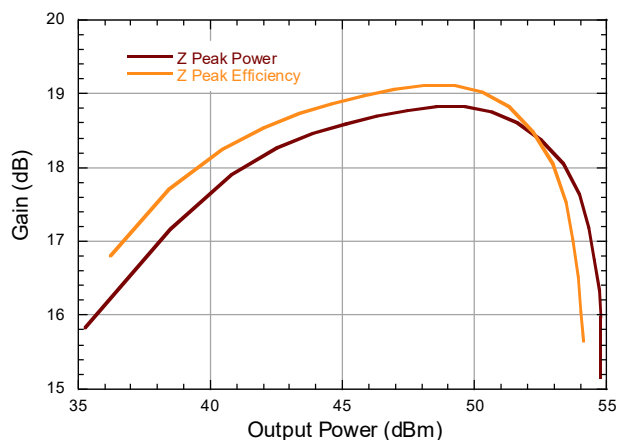

Drain Efficiency vs. Output Power

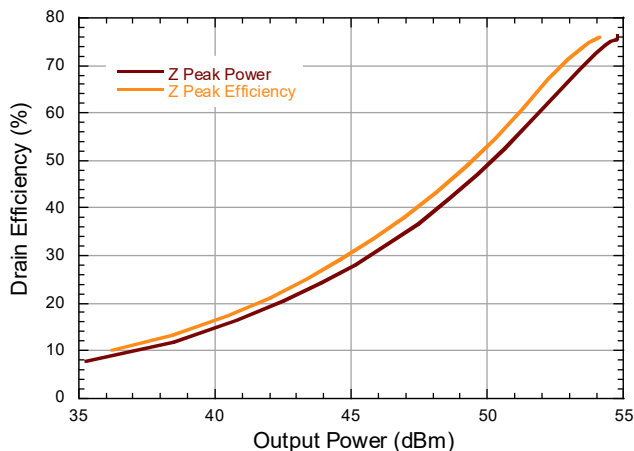

Evaluation Test Fixture and Recommended Tuning Solution 2.4 - 2.5 GHz

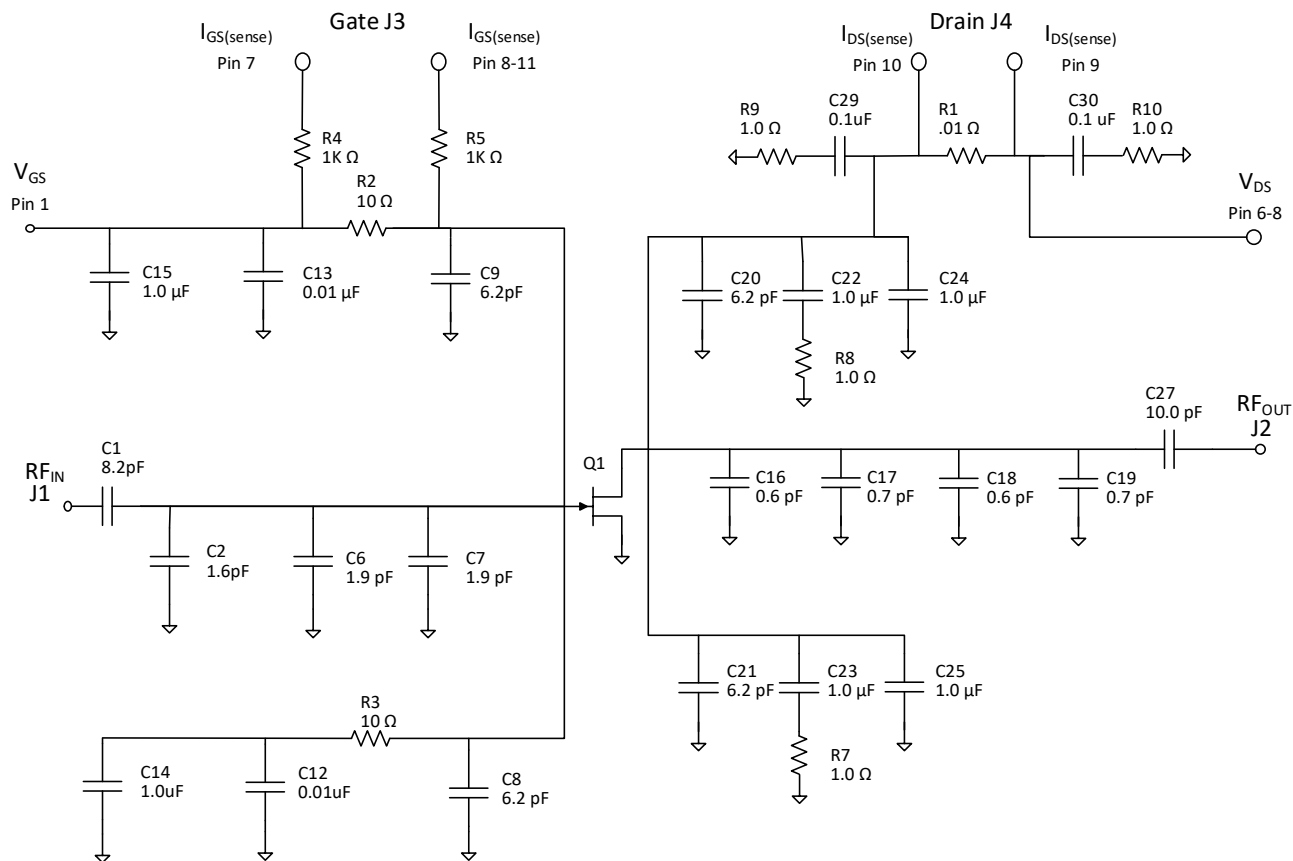

Description

Parts measured on evaluation board (30-mil thick RO4350). Matching is provided using a combination of lumped elements and transmission lines as shown in the simplified schematic above. Recommended tuning solution component placement, transmission lines, and details are shown on the next page.

Bias Sequencing

Turning the device ON

1. Set V_{GS} to pinch-off (V_P).
2. Turn on V_{DS} to nominal voltage (50 V).
3. Increase V_{GS} until I_{DS} current is reached.
4. Apply RF power to desired level.

Turning the device OFF

1. Turn the RF power off.
2. Decrease V_{GS} down to V_P pinch-off.
3. Decrease V_{DS} down to 0 V.
4. Turn off V_{GS} .

Evaluation Test Fixture and Recommended Tuning Solution 2.4 - 2.5 GHz

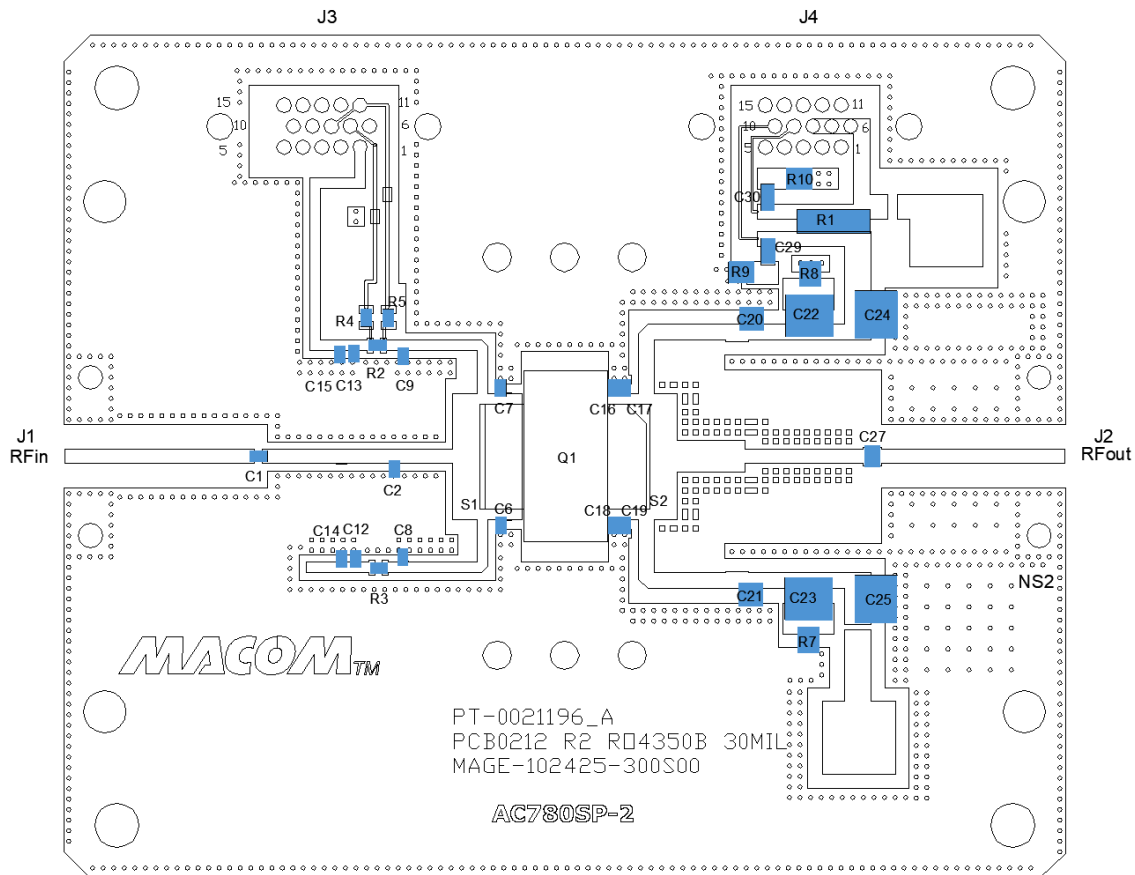

Reference Designator	Value	Tolerance	Manufacturer	Part Number
C1	8.2 pF	+/-0.25 pF	Passive Plus	0805N8R2CW251T
C2	1.6 pF	+/-0.1 pF	Passive Plus	0805N1R6CW251T
C6,C7	1.9 pF	+/-0.1 pF	Passive Plus	0805N1R9CW251T
C8,C9	6.2 pF	+/-0.25 pF	Passive Plus	0805N6R2CW251T
C13, C12	0.01 µF	+/-20%	Murata	GRM216R71H103MA01D
C14, C15	1 µF	+/-10%	Murata	GRM219R7YA105KA12D
C16, C18	0.6 pF	+/-0.05 pF	Passive Plus	0805N0R6CW251T
C17, C19	0.7 pF	+/-0.05 pF	Passive Plus	0805N0R7CW251T
C27	10 pF	+/-0.25 pF	Passive Plus	0708N100JW501XT
C20, C21	6.2 pF	+/-0.1 pF	Passive Plus	1111N6R2BW501XT
C29, C30	0.1 µF	+/-15%	Murata	GRM31CR72D104K03
C22, C23, C24, C25	1 µF	+/-15%	Murata	GRM55DR72D105KW01
R1	0.01 Ω	+/-1%	Viking	CS75FTFR010
R2, R3	10 Ω	+/-1%	Viking	CR-05FL7---10R
R4, R5	1K Ω	+/-1%	Viking	CR-05FL7---1K
R7, R8, R9, R10	1 Ω	+/-1%	Panasonic	ERJ-14BQF1R0U
Q1	MACOM GaN Power Amplifier		MAGE-102425-300S00	
PCB	RO4350, 30 mil, 1 oz. Cu, Au Finish			

7

MACOM Technology Solutions Inc. (MACOM) and its affiliates reserve the right to make changes to the product(s) or information contained herein without notice. Visit www.macom.com for additional data sheets and product information.

For further information and support please visit: <https://www.macom.com/support>

Typical Performance Curves as Measured in the 2.4 - 2.5 GHz Evaluation Test Fixture:
Pulsed⁴ 2.5 GHz, $V_{DS} = 50\text{ V}$, $I_{DQ} = 300\text{ mA}$, $T_C = 25^\circ\text{C}$ (Unless Otherwise Noted)

Gain vs. Output Power and Frequency

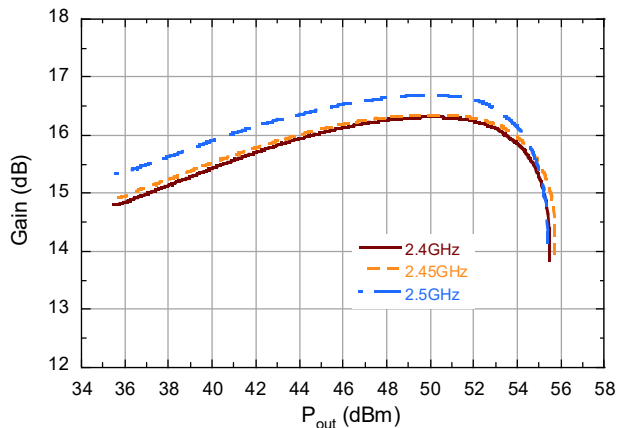

Drain Efficiency vs. Output Power and Frequency

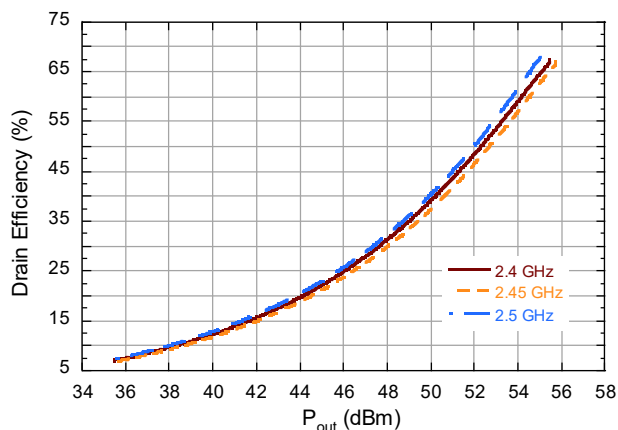

Gain vs. Output Power and V_{DS}

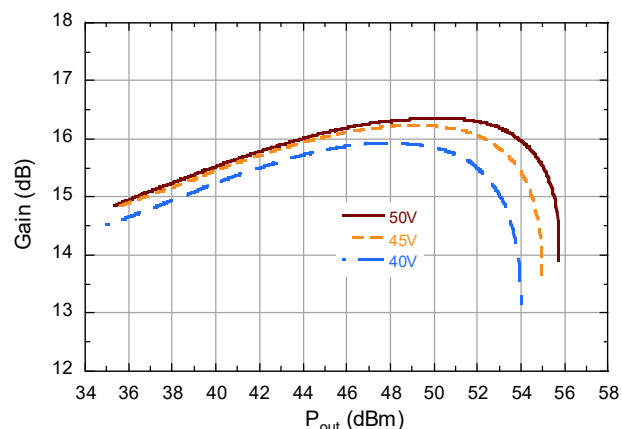

Drain Efficiency vs. Output Power and V_{DS}

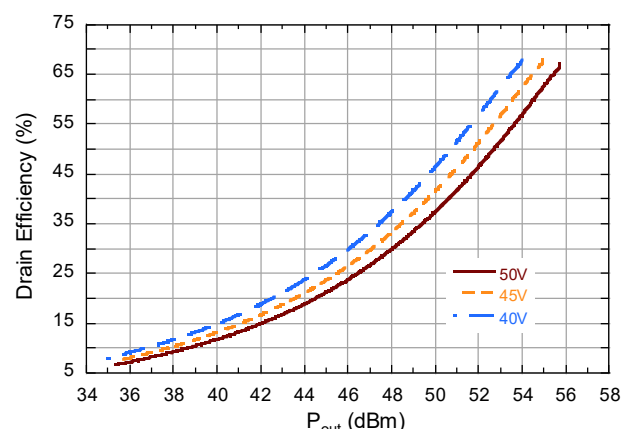

Gain vs. Output Power and I_{DQ}

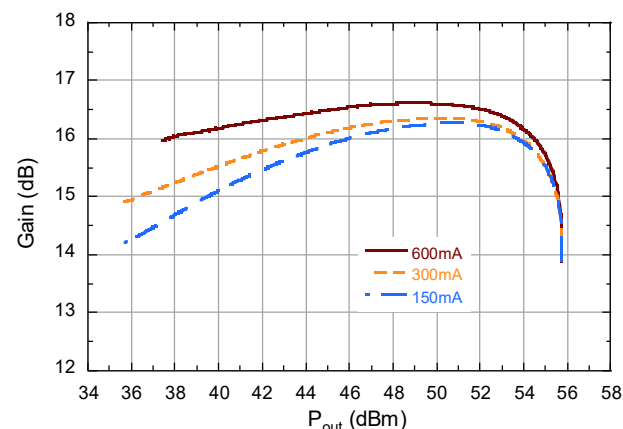

Drain Efficiency vs. Output Power and I_{DQ}

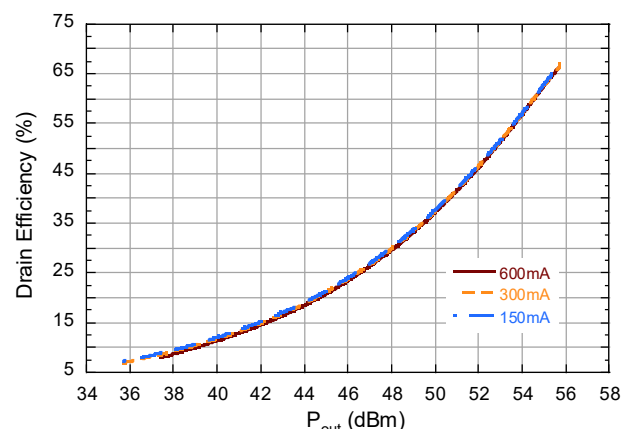

Typical Performance Curves as Measured in the 2.4 - 2.5 GHz Evaluation Test Fixture:
 Pulsed⁴ 2.5 GHz, $V_{DS} = 50\text{ V}$, $I_{DQ} = 300\text{ mA}$, $T_C = 25^\circ\text{C}$ (Unless Otherwise Noted)

Gain vs. Output Power and Temperature

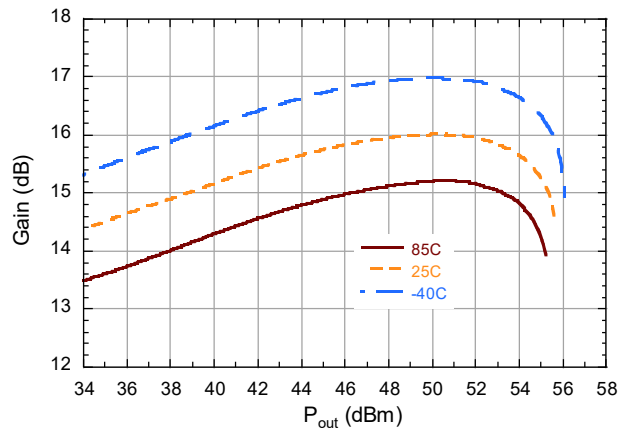

Drain Efficiency vs. Output Power and Temperature

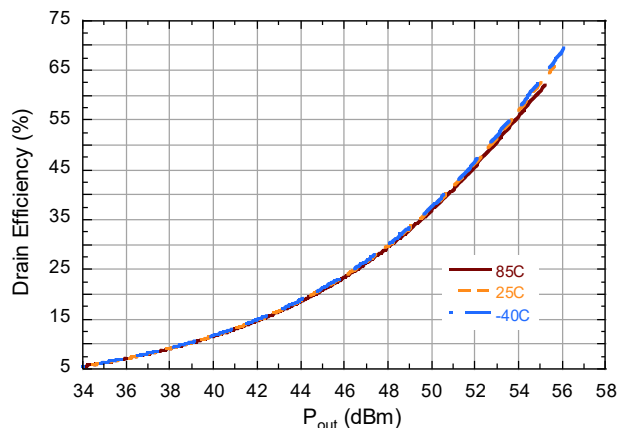

CW, 2.0 dB Compression, Gain vs. Frequency

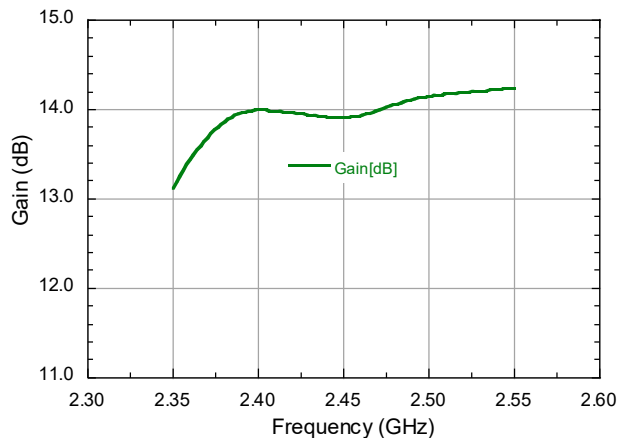

CW, 2.0 dB Compression, Drain Efficiency vs. Frequency

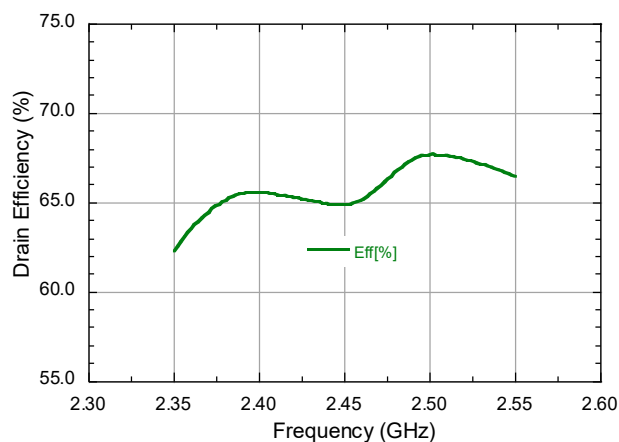

CW, 2.0 dB Compression, Output Power vs. Frequency

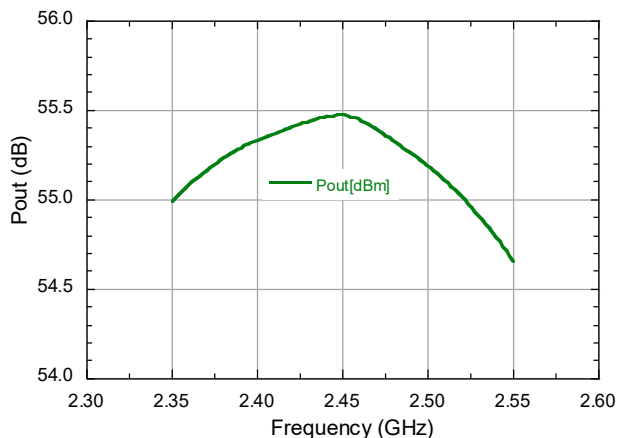

Lead-Free AC-780S-2 Package Dimensions[†]

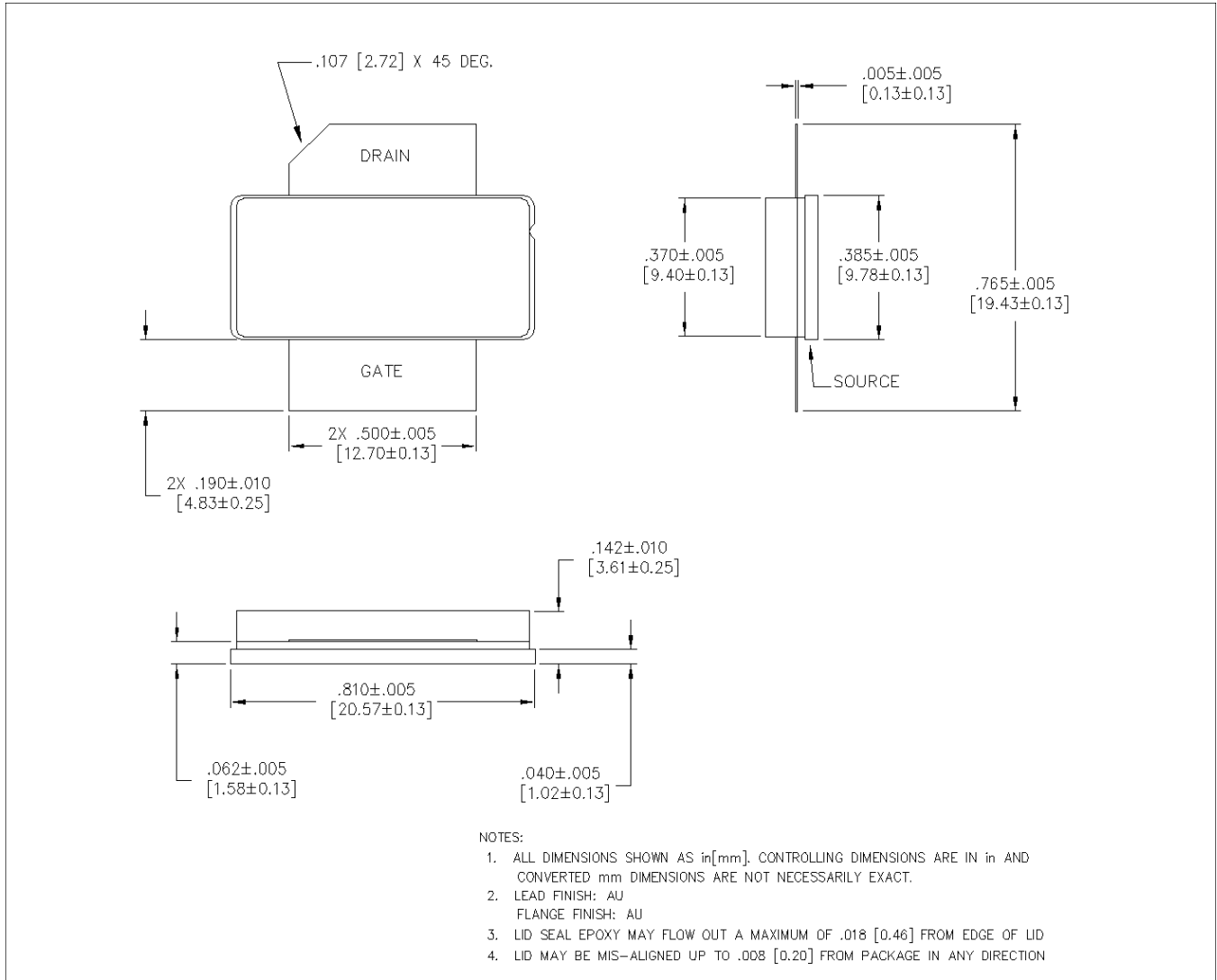

[†] Reference Application Note AN0004363 for lead-free solder reflow recommendations.
Meets JEDEC moisture sensitivity level 3 requirements.
Plating is Au.