

Sub-Harmonic Pumped Mixer 14 - 32 GHz

Rev. V1

Features

- Up or Down Frequency Mixer
- Low Conversion Loss: 11 dB
- 2xLO & 3xLO Rejection: 50 dB
- RF Frequency: 14 - 32 GHz
- LO Frequency: 4 - 20 GHz
- IF Frequency: DC - 7 GHz
- Lead-Free 1.5x1.2 mm 6-lead TDFN Package
- Halogen-Free “Green” Mold Compound
- RoHS* Complaint and 260°C Reflow

Description

The MAMX-011009 is a lead-free 1.5 x 1.2 mm TDFN surface mount plastic packaged sub-harmonic mixer. No bias is required, although DC-offset on the IF port can improve performance.

The MAMX-011009 can be used for up or down frequency conversion. The mixer integrates an 180° balanced diode topology that allows the LO to be injected at ½ the mixing LO frequency. This improves LO isolation and simplifies system requirements.

When used as a down converting mixer, it can convert RF port signals from 14 to 32 GHz to IF port signals of DC to 7 GHz.

When used as an up converting mixer, it can convert IF port signals from DC to 7 GHz to RF port signals of 14 to 32 GHz.

In either mode the +15 dBm LO signal of 4 to 20 GHz drives the frequency conversion at ½ the mixing product. Typical conversion loss is 11 dB with 2xLO and 3xLO isolation typically greater than 50 dB. Typical input IP3 is greater than +12 dBm.

Functional Schematic

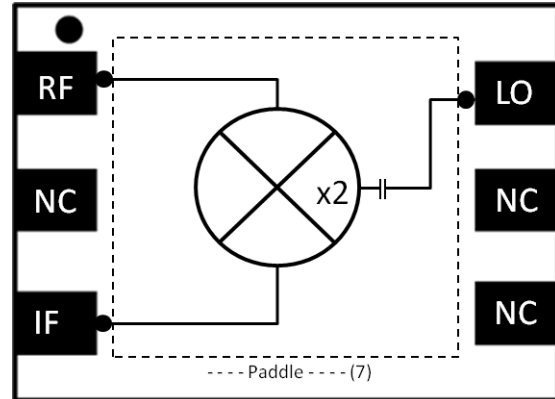

Pin Configuration¹

Pin No.	Pin Name	Description
1	RF	Mixer RF port
2	N/C	No Connection
3	IF	Mixer IF port
4	N/C	No Connection
5	N/C	No Connection
6	LO	Mixer LO port
7	Paddle ²	Primary Ground

1. M/A-COM Technology Solutions recommends connecting unused package pins to ground.
2. The exposed pad centered on the package bottom must be connected to RF and DC ground.

Ordering Information^{3,4}

Part Number	Package
MAMX-011009	bulk
MAMX-011009-TR1000	1000 piece reel
MAMX-011009-001SMB	Sample Board

3. Reference Application Note M513 for reel size information.
4. All sample boards include 5 loose parts.

* Restrictions on Hazardous Substances, European Union Directive 2002/95/EC.

Sub-Harmonic Pumped Mixer 14 - 32 GHz

Rev. V1

Electrical Specifications: IF Freq. = 2 GHz, LO Drive = +15 dBm, $T_A = 25^\circ\text{C}$, $Z_0 = 50 \Omega$
Unless otherwise noted all measurement are as an up converter.

Parameter	Test Conditions	Units	Min.	Typ.	Max.
Frequency	RF IF LO	GHz	—	24 2 11	—
RF Return Loss	16 - 30 GHz	dB	—	8	—
IF Return Loss	DC - 7 GHz	dB	—	10	—
Down Conversion Loss	16 GHz 24 GHz 32 GHz	dB	—	13 11 12	—
Up Conversion Loss	16 GHz 24 GHz 32 GHz	dB	—	12 10 11	— 11 —
Input IP3	Down Conversion Up Conversion	dB	—	+12 +14	—
Down Conversion Isolation	LO to IF 2LO to IF 3LO to IF RF to IF	dB	—	30 55 50 18	—
Up Conversion Isolation	LO to RF ⁵ 2LO to RF ⁵ 3LO to RF IF to RF	dB	18 48 — —	25 50 40 35	—

5. Measured at 24 GHz RF.

Absolute Maximum Ratings^{6,7}

Parameter	Absolute Maximum
Input Power	+25 dBm
Junction Temperature ⁸	+150°C
Operating Temperature	-40°C to +85°C
Storage Temperature	-65°C to +150°C

6. Exceeding any one or combination of these limits may cause permanent damage to this device.
7. M/A-COM Technology Solutions does not recommend sustained operation near these survivability limits.
8. Operating at nominal conditions with $T_J \leq +150^\circ\text{C}$ will ensure $\text{MTTF} > 1 \times 10^6$ hours.

Handling Procedures

Please observe the following precautions to avoid damage:

Static Sensitivity

Gallium Arsenide Integrated Circuits are sensitive to electrostatic discharge (ESD) and can be damaged by static electricity. Proper ESD control techniques should be used when handling these Class 1A (HBM) devices.

PCB Layout

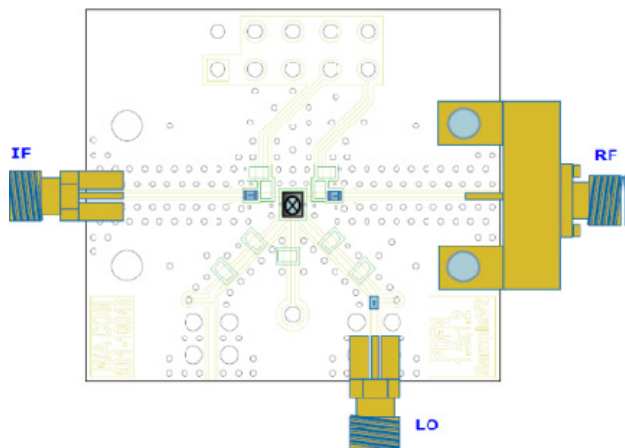

PCB Footprint

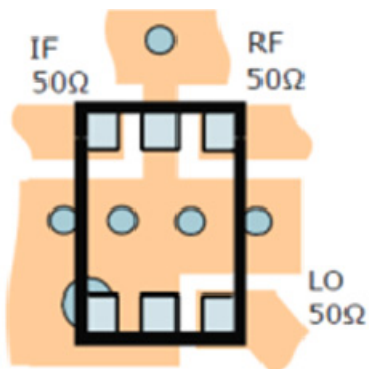

Parts List

Part	Value	Case Style
R1 - R3	0 Ω	0201

Application Schematic

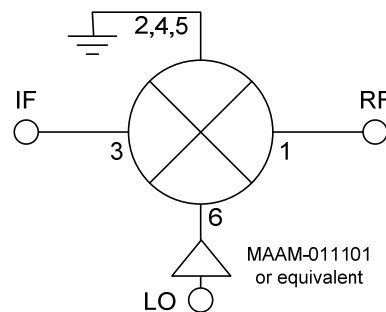

Application Information

The MAMX-011009 is designed to be economical and easy to use. By employing a sub-harmonic topology, the user only has to deal with one high frequency port (RF). This simplifies system design, lowers cost, and combined with an ultra-small plastic package delivers a superior system solution.

The MAMX-011009 design allows bi-direction frequency conversion (IF to RF or RF to IF). The conversion loss, isolation, and linearity are similar either way.

For proper up or down frequency mixing the MAMX-011009 must be driven with sufficient power to activate the mixing diodes, typically 14 dBm or higher. We highly recommend M/A-COM Technology Solutions MAAM-011101, which has been engineered to match the LO requirements of the MAMX-011009.

Grounding

The printed circuit board (PCB) layout is simple for the MAMX-011009 since no external components are needed. The LO port is internally DC blocked; DC voltages up to 20 V are acceptable. However, proper grounding must be used for operation. It is recommended that the total common ground inductance not exceed 0.03 nH. This is equivalent to placing a least four 8-mil (200 μm) diameter vias under the device, assuming an 8-mil (200 μm) thick RF layer to ground. More ground vias are recommended if possible.

Up Conversion Summary

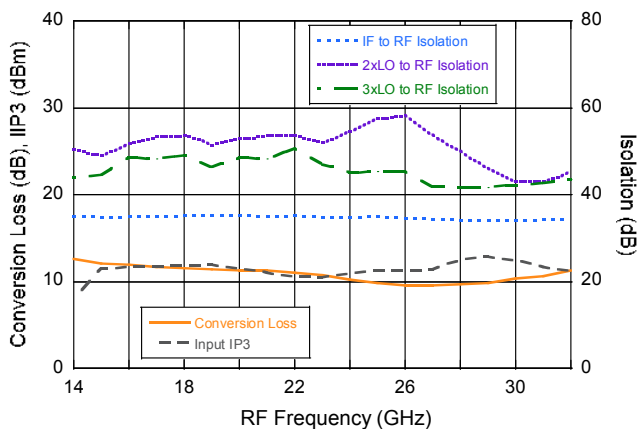

Sub-Harmonic Pumped Mixer 14 - 32 GHz

Rev. V1

Typical Performance Curves for Down Conversion: $T_A = 25^\circ\text{C}$, $\text{RF} = -10 \text{ dBm}$, $\text{LO} = 15 \text{ dBm}$, $\text{LO} = 1/2x (\text{RF} + \text{IF}) \text{ GHz}$, $\text{IF} = 2 \text{ GHz}$, $Z_{\text{RF}} = Z_{\text{LO}} = Z_{\text{IF}} = 50 \Omega$, unless noted

Conversion Gain vs. RF Frequency

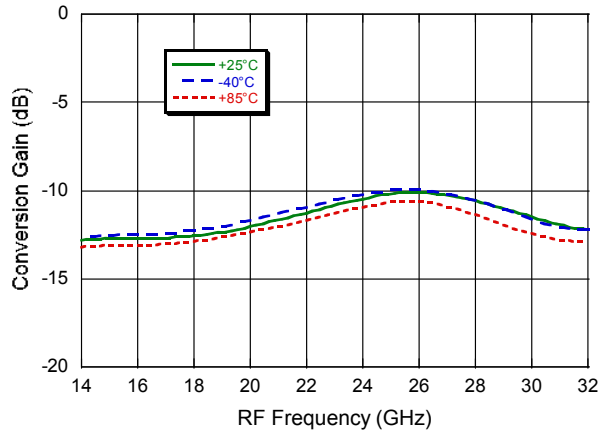

Input IP3 vs. RF Frequency (LO = +16 dBm)

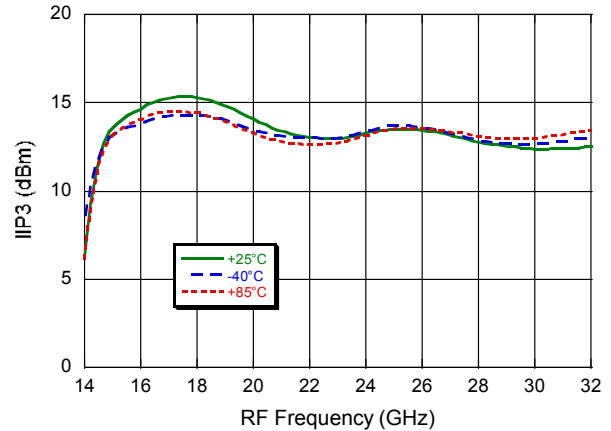

LO Leakage

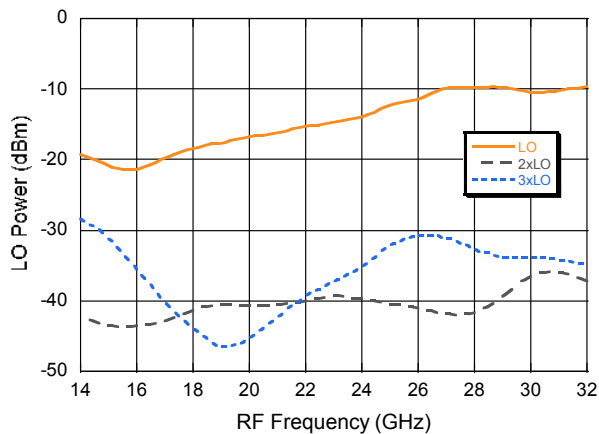

Input IP3 vs. LO Drive Level

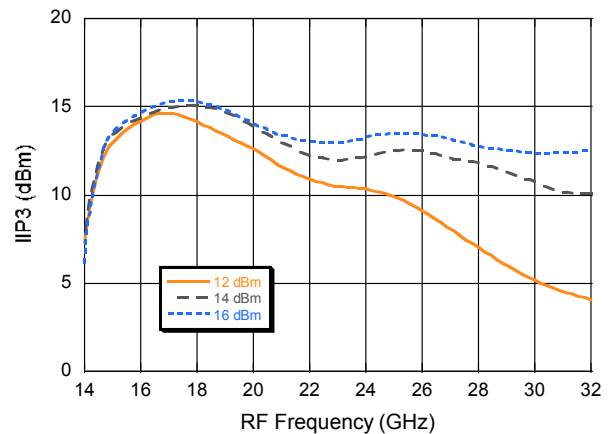

Isolation

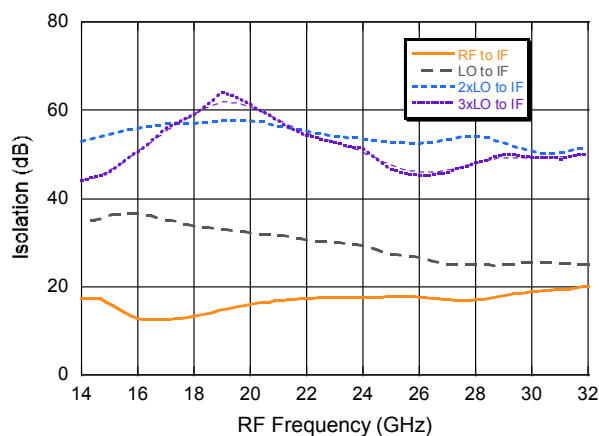

Conversion Gain vs. IF Frequency

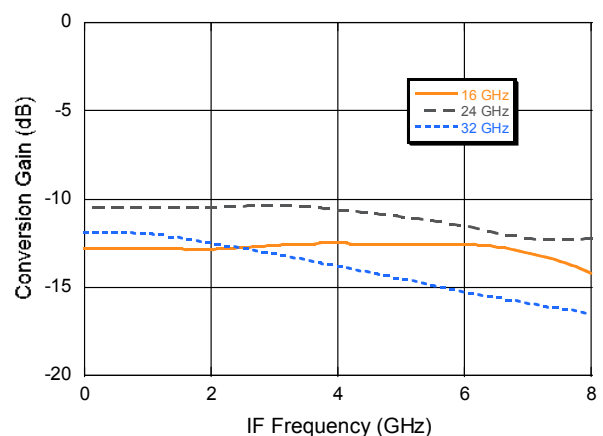

Sub-Harmonic Pumped Mixer 14 - 32 GHz

Rev. V1

Typical Performance Curves for Up Conversion: $T_A = 25^\circ\text{C}$, $IF = -10\text{ dBm}$, $LO = 15\text{ dBm}$, $LO = 1/2x (RF+IF)\text{ GHz}$, $IF = 2\text{ GHz}$, $Z_{RF}=Z_{LO}=Z_{IF} = 50\ \Omega$, unless noted

Conversion Gain vs. RF Frequency

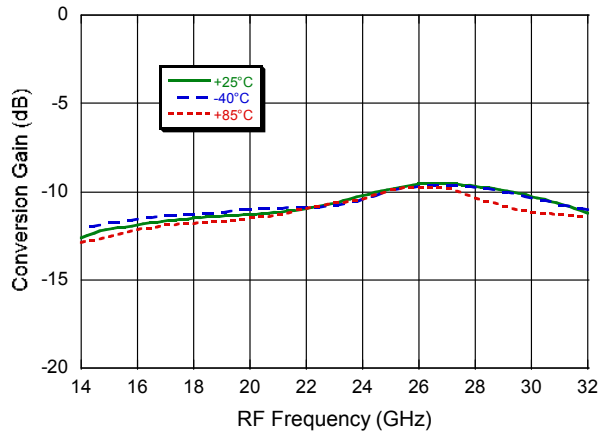

Input IP3 vs. RF Frequency (LO = +16 dBm)

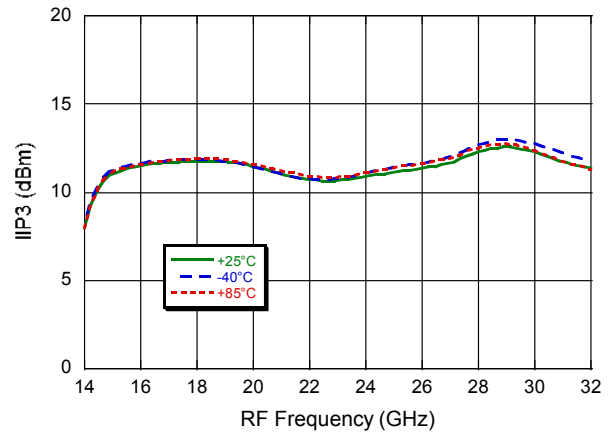

LO Leakage

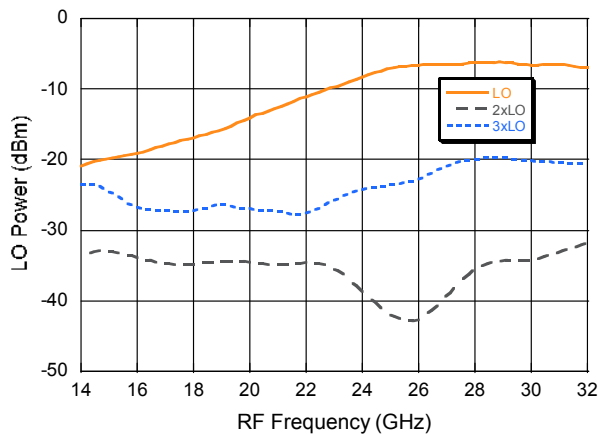

Input IP3 vs. LO Drive Level

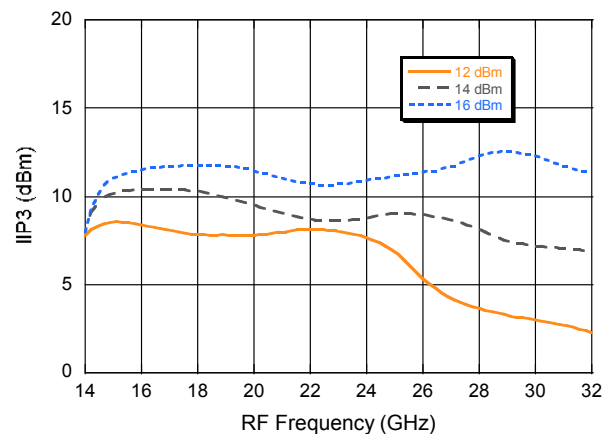

Isolation

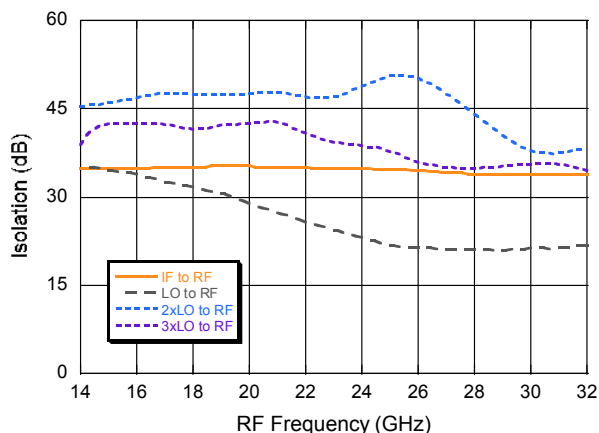

Conversion Gain vs. IF Frequency

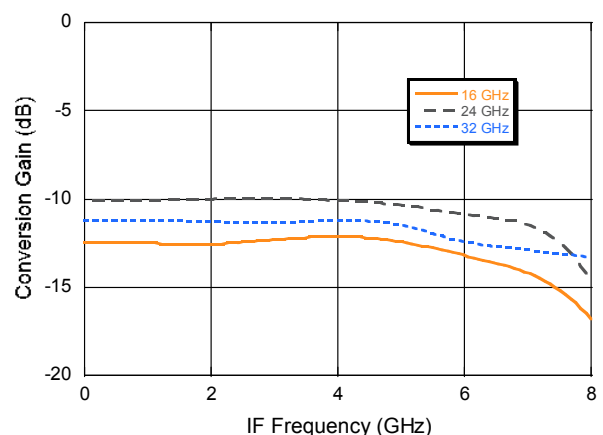

Typical Performance Curves:

Down Conversion Gain vs. LO Drive

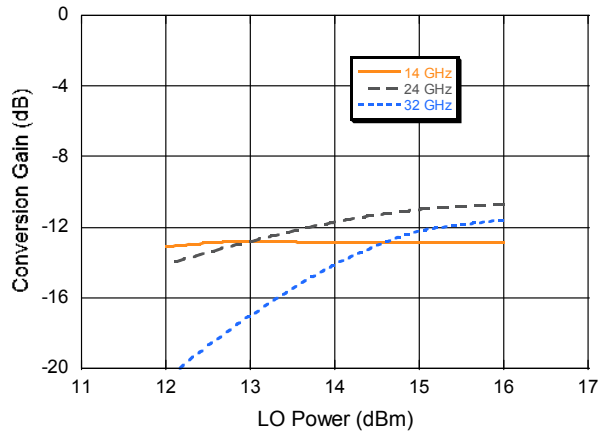

Down Conversion Input IP3 vs. LO drive

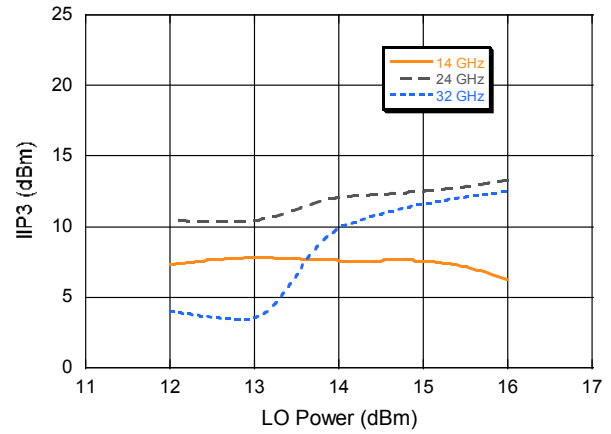

Up conversion Gain vs. LO Drive

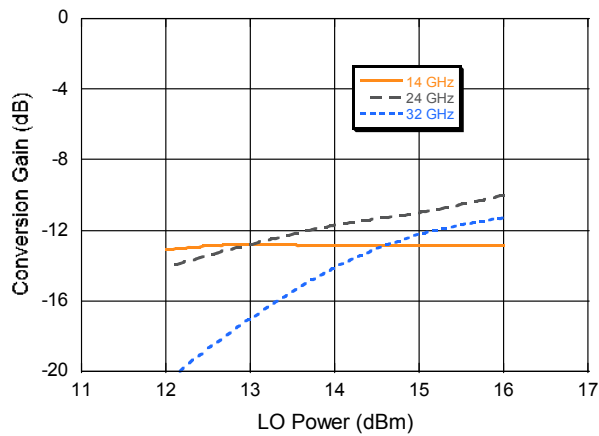

Up Conversion Input IP3 vs. LO Drive

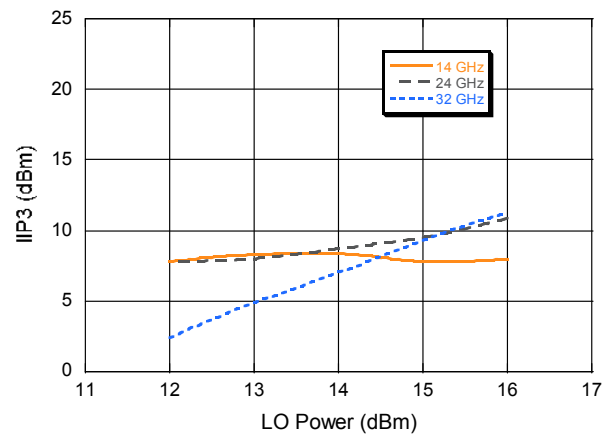

RF Return Loss

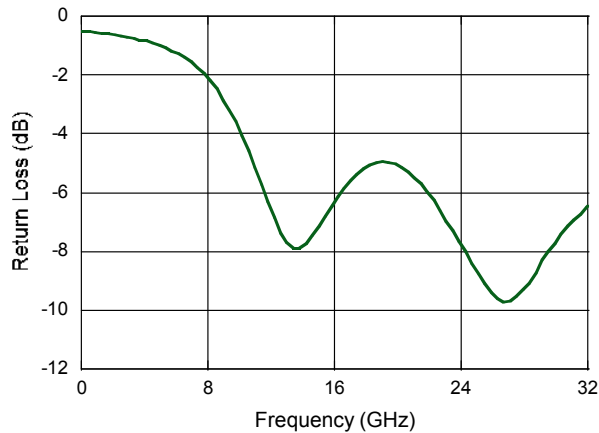

IF Return Loss

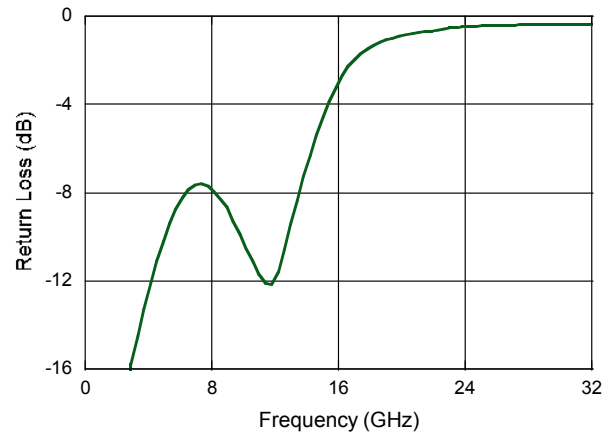

Lead-Free 1.5 x 1.2 mm 6-Lead TDFN[†]

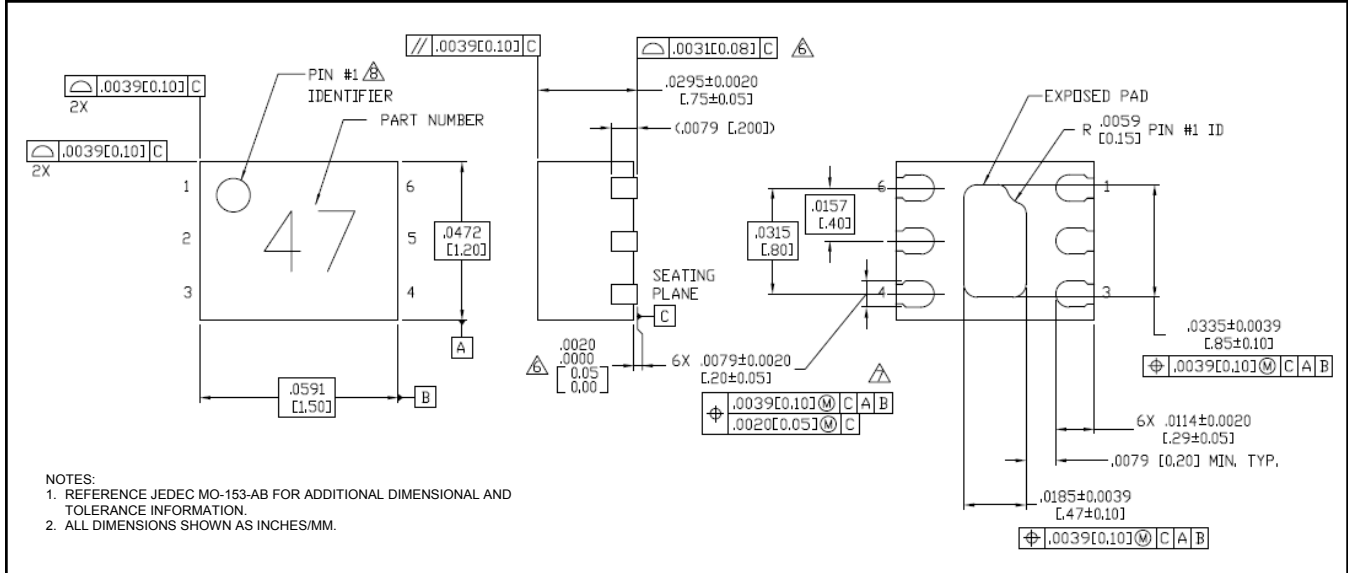

[†] Reference Application Note S2083 for lead-free solder reflow recommendations.
 Meets JEDEC moisture sensitivity level 1 requirements.
 Plating is 100% matte tin over copper.