

Image Reject Mixer

8 - 26 GHz



MAMX-011075

Rev. V2

Features

- Passive Mixer (No Bias Required)
- Usable as IR Downconverter
- Usable as Single Sideband (SSB) Upconverter
- Low Conversion Loss: 9 dB
- Nominal LO drive of +14 dBm
- Operates at LO level of +10 dBm
- High Linearity: 17 dBm IIP3
- High Image Rejection: 25 dBc
- Wide IF Bandwidth: DC to 4 GHz
- High Isolation
- 4 mm AQFN Package
- RoHS* Compliant

Applications

- Test & Measurement, Microwave Radio, & Radar

Description

The MAMX-011075 is an image-reject passive diode mixer MMIC. The mixer offers low conversion loss, high linearity, high image rejection and a wide IF bandwidth. The image-reject circuit configuration provides excellent port isolation while internal 50 Ω matching simplifies its application.

This mixer is well suited for applications such as test and measurement, microwave radio and radar.

Ordering Information^{1,2}

Part Number	Package
MAMX-011075	Bulk
MAMX-011075-TR0500	500 Piece Reel
MAMX-011075-SB1	Sample Board

1. Reference Application Note M513 for reel size information.
2. All sample boards include 5 loose parts.

Functional Schematic

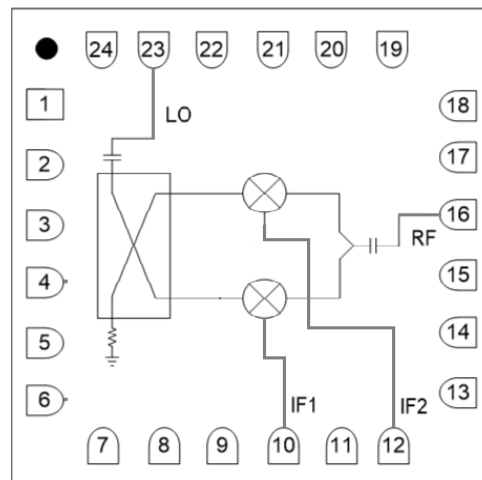

Pin Configuration³

Pin #	Function
1 - 9, 11, 13 - 15, 17 - 22, 24	Ground
10	IF1
12	IF2
16	RF
23	LO
25 ³	Ground Pad

3. The exposed pad centered on the package bottom must be connected to RF, DC and thermal ground.

¹ * Restrictions on Hazardous Substances, compliant to current RoHS EU directive.

Image Reject Mixer

8 - 26 GHz



MAMX-011075

Rev. V2

Electrical Specifications⁴: $F_{IF} = 100 \text{ MHz}$, $P_{LO} = +14 \text{ dBm}$, $T_A = +25^\circ\text{C}$, $Z_0 = 50 \Omega$

Parameter	Test Conditions	Units	Min.	Typ.	Max.
LO and RF Frequency	—	GHz	8	—	26
IF Frequency	—	GHz	0	—	4
LO Power	—	dBm	—	14	—
Conversion Loss	8 - 12 GHz 12 - 26 GHz	dB	—	8.0 9.0	9.5 11.5
Input P1dB	—	dBm	—	8	—
Input IP3	$P_{RF} = -10 \text{ dBm/tone}$, $\Delta f = 1 \text{ MHz}$	dBm	—	17	—
Input IP2	—	dBm	—	40	—
Isolation	LO-to-RF, 8 - 26 GHz LO-to-IF, 8 - 26 GHz RF-to-IF, 8 - 26 GHz	dB	—	35 35 15	—
Image Rejection	8 - 26 GHz	dBc	17	25	—
Amplitude Imbalance	8 - 26 GHz	dB	—	± 2	—
Phase Imbalance	8 - 26 GHz	°	—	± 10	—
RF Return Loss	8 - 26 GHz	dB	—	6	—
IF Return Loss	0.1 - 4.0 GHz	dB	—	12	—

4. All specifications refer to down-conversion operation, unless otherwise noted.

Absolute Maximum Ratings^{5,6}

Parameter	Absolute Maximum
LO Power	23 dBm
RF or IF Power	20 dBm
Junction Temperature ⁷	+150°C
Operating Temperature	-40°C to +85°C
Storage Temperature	-65°C to +150°C

- Exceeding any one or combination of these limits may cause permanent damage to this device.
- MACOM does not recommend sustained operation near these survivability limits.
- Operating at nominal conditions with $T_J \leq +150^\circ\text{C}$ will ensure $\text{MTTF} > 1 \times 10^6$ hours. Thermal resistance, Θ_{JC} is 85°C/W .

Handling Procedures

Please observe the following precautions to avoid damage:

Static Sensitivity

These electronic devices are sensitive to electrostatic discharge (ESD) and can be damaged by static electricity. Proper ESD control techniques should be used when handling these devices with the following JEDEC rating:

HBM Class 1A
CDM Class C3

Image Reject Mixer

8 - 26 GHz



MAMX-011075

Rev. V2

Typical Performance Curves: Lower Side Band (LSB), High Side LO

Data captured with 90° Hybrid @ 100 MHz IF

Down Conversion Gain over LO drive

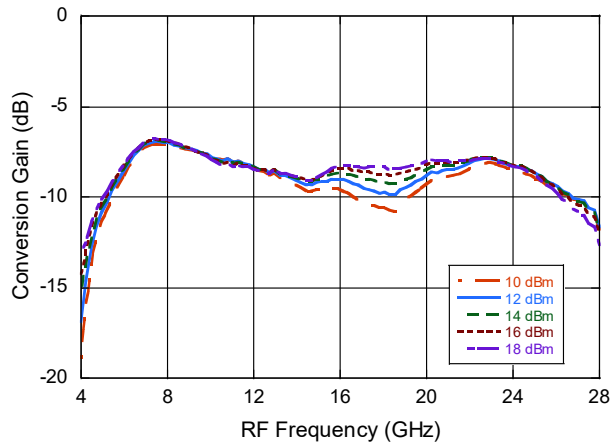

Down Conversion Image Rejection over LO drive

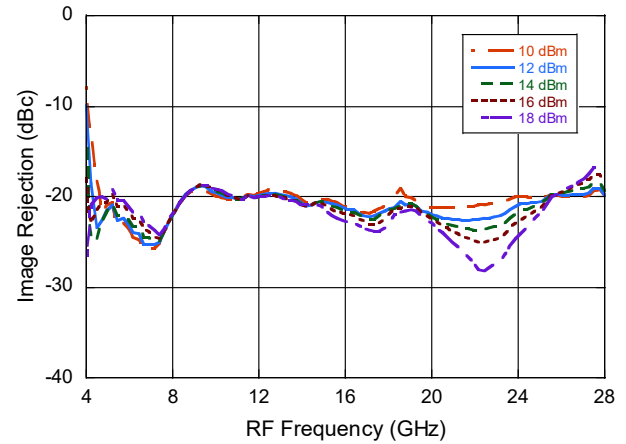

Down Conversion Gain over temperature

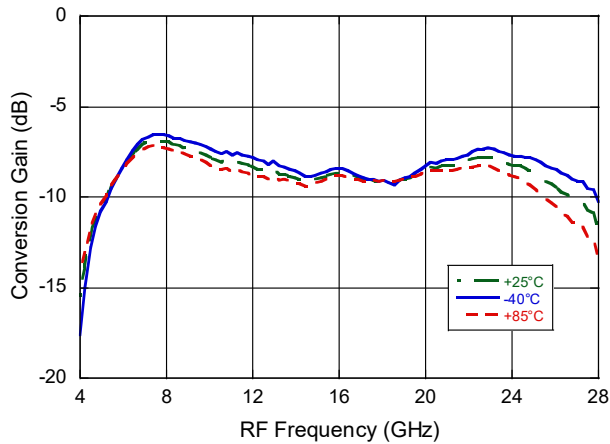

Down Conversion Image Rejection over temperature

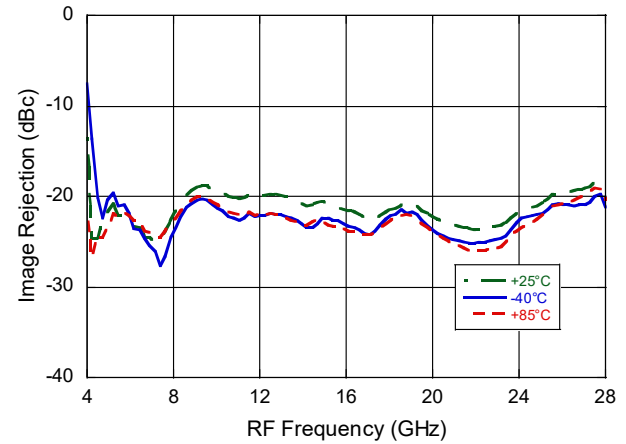

Amplitude Imbalance over LO drive

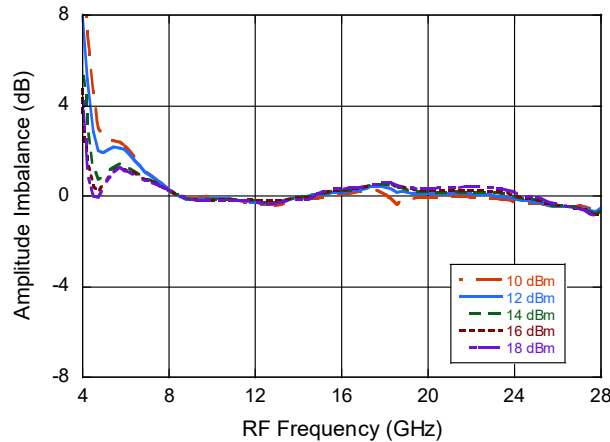

Phase Imbalance over LO drive

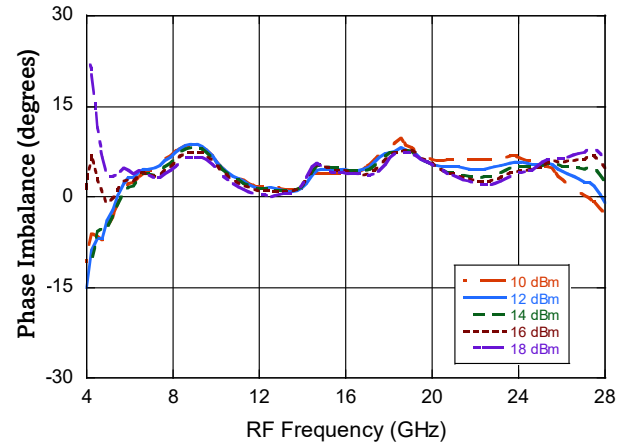

Image Reject Mixer 8 - 26 GHz



MAMX-011075

Rev. V2

Typical Performance Curves: Lower Side Band (LSB), High Side LO Data captured with 90° Hybrid @ 100 MHz IF

IIP3 over LO drive

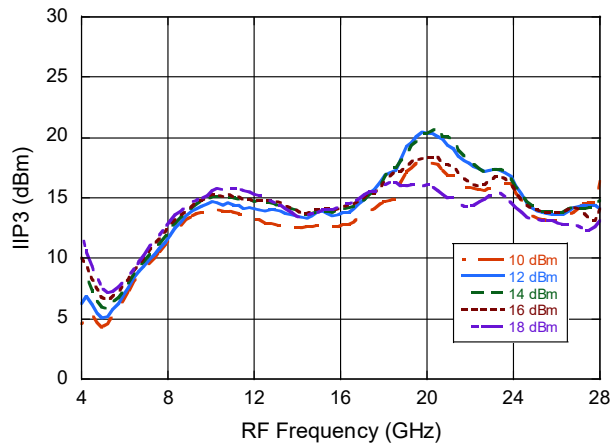

IIP2 over LO drive

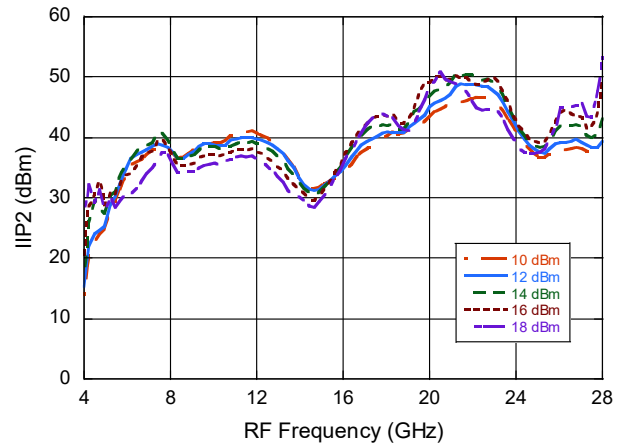

IIP3 over temperature

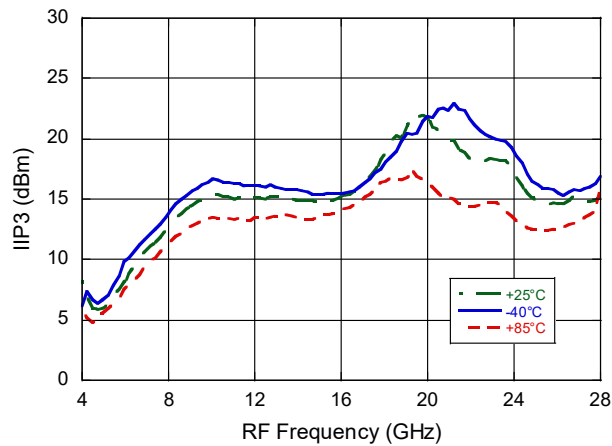

IIP2 over temperature

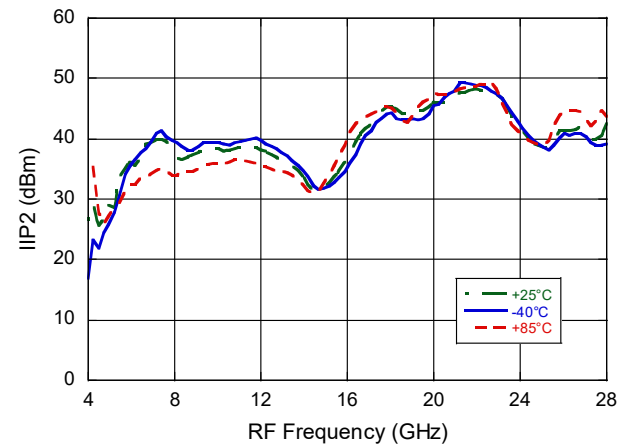

Image Reject Mixer

8 - 26 GHz



MAMX-011075

Rev. V2

Typical Performance Curves: Upper Side Band (USB), Low Side LO

Data captured with 90° Hybrid @ 100 MHz IF

Down Conversion Gain over LO drive

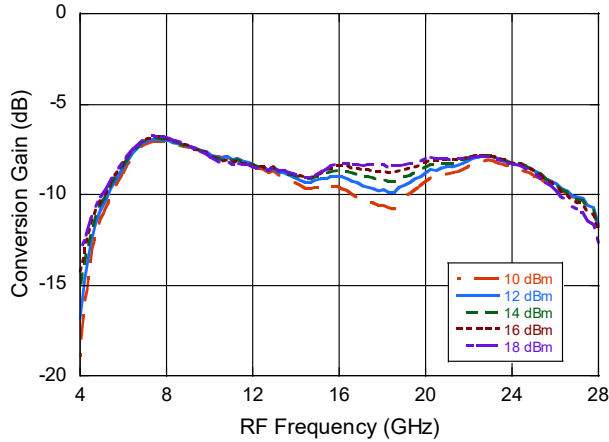

Down Conversion Image Rejection over LO drive

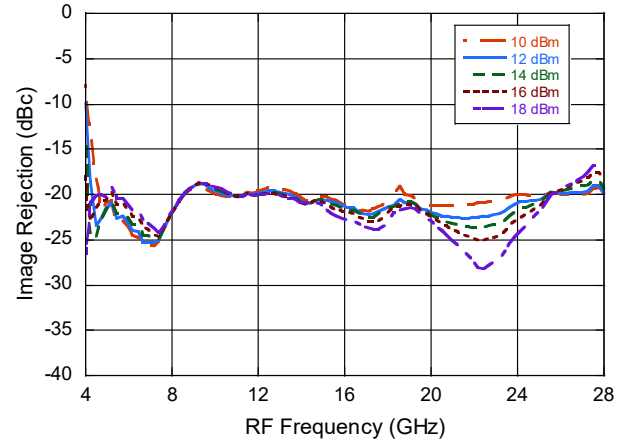

Down Conversion Gain over temperature

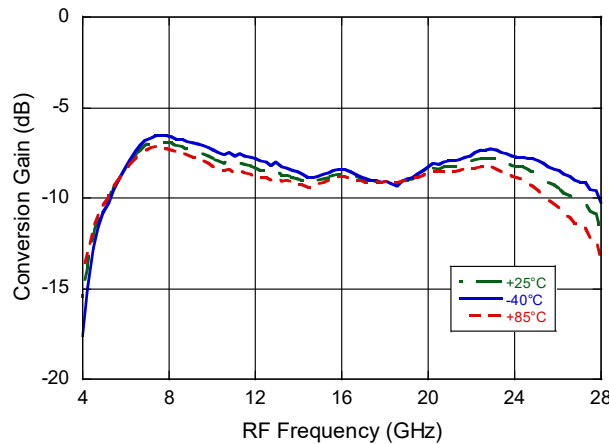

Down Conversion Image Rejection over temperature

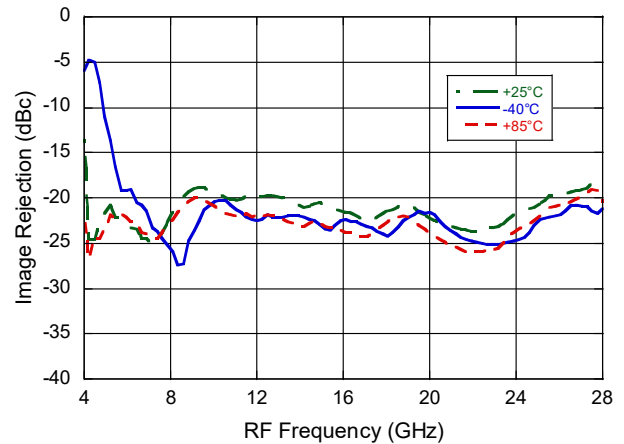

Amplitude Imbalance over LO drive

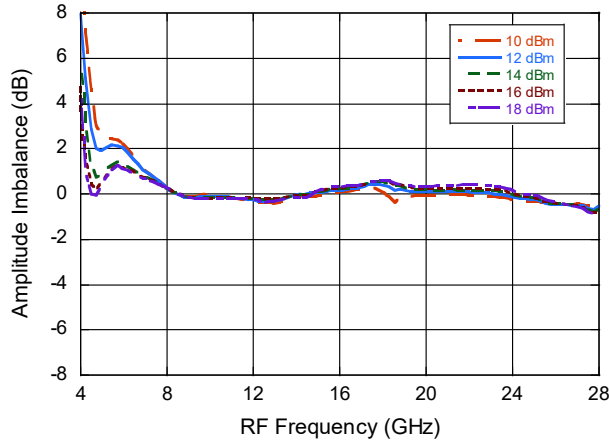

Phase Imbalance over LO drive

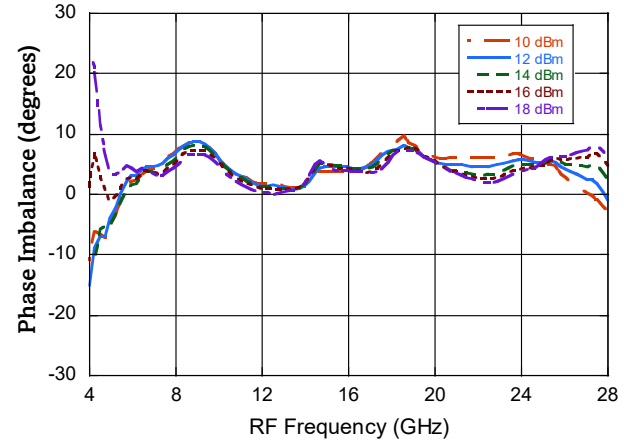

Image Reject Mixer

8 - 26 GHz



MAMX-011075

Rev. V2

Typical Performance Curves: Upper Side Band (USB), Low Side LO

Data captured with 90° Hybrid @ 100 MHz IF

IIP3 over LO drive

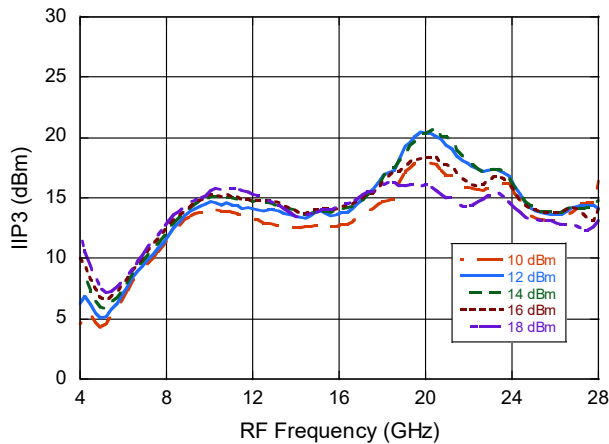

IIP2 over LO drive

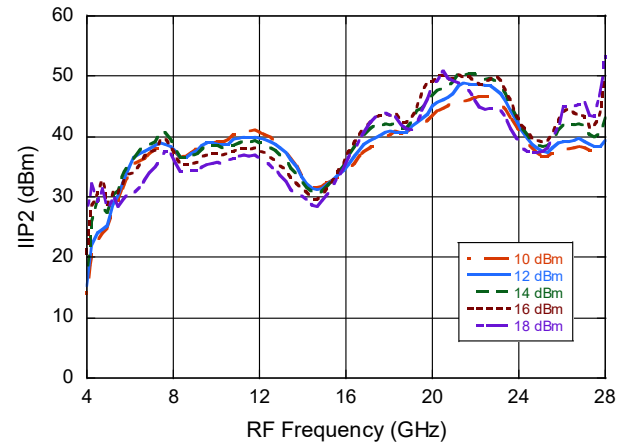

IIP3 over temperature

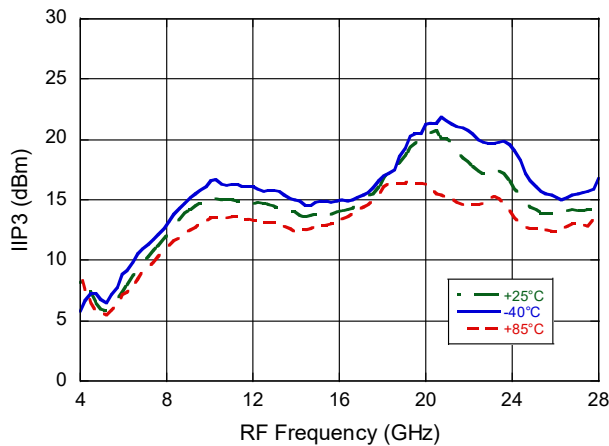

IIP2 over temperature

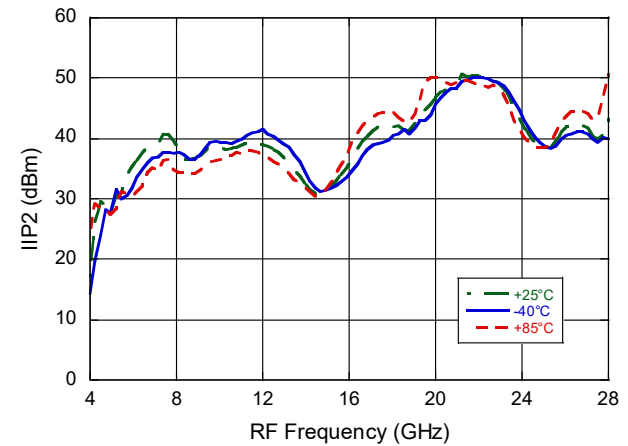

Image Reject Mixer

8 - 26 GHz



MAMX-011075

Rev. V2

Typical Performance Curves: Lower Side Band (LSB), High Side LO

Data captured with 90° Hybrid @ 100 MHz IF

Up Conversion Gain over LO drive

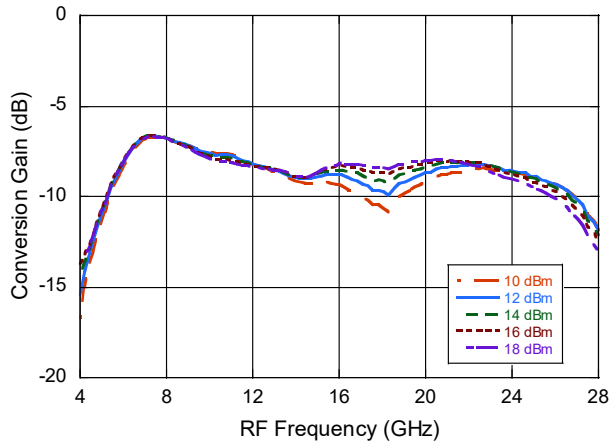

Up Conversion SSB over LO drive

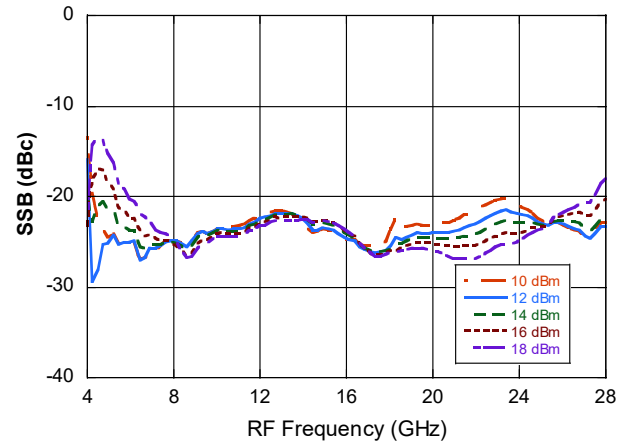

Typical Performance Curves: Upper Side Band (USB), Low Side LO

Data captured with 90° Hybrid @ 100 MHz IF

Up Conversion Gain over LO drive

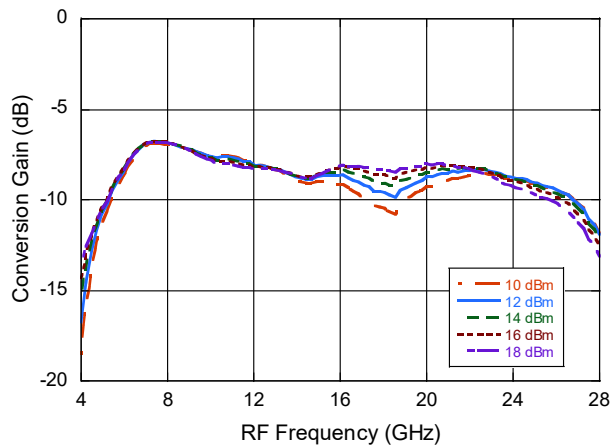

Up Conversion SSB over LO drive

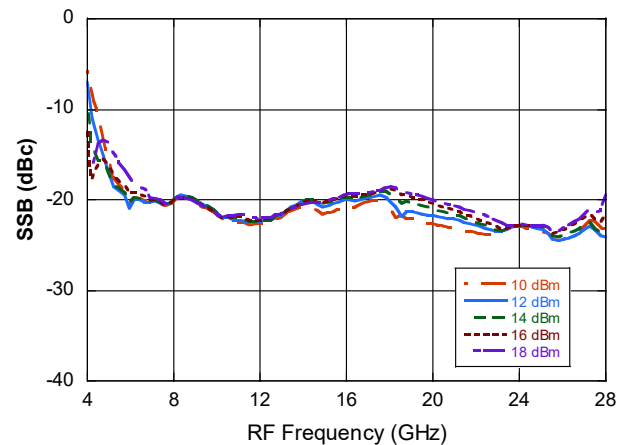

Image Reject Mixer

8 - 26 GHz



MAMX-011075

Rev. V2

Typical Performance Curves: Lower Side Band (LSB), High Side LO

Data captured with 90° Hybrid @ 2 GHz IF

Down Conversion Gain over LO drive

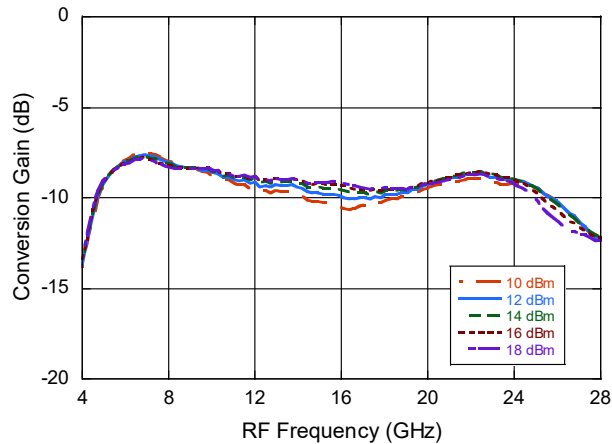

Down Conversion Image Rejection over LO drive

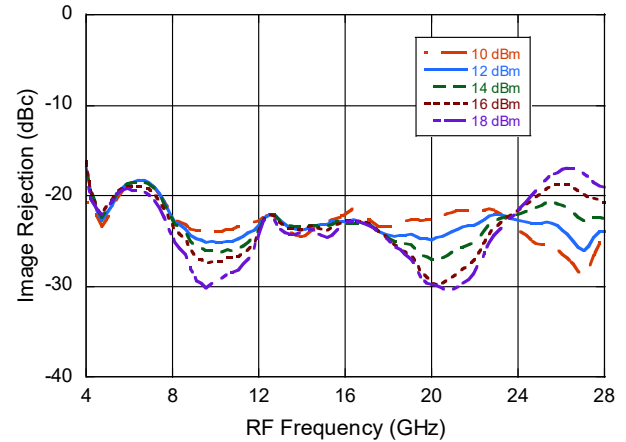

IIP3 over LO drive

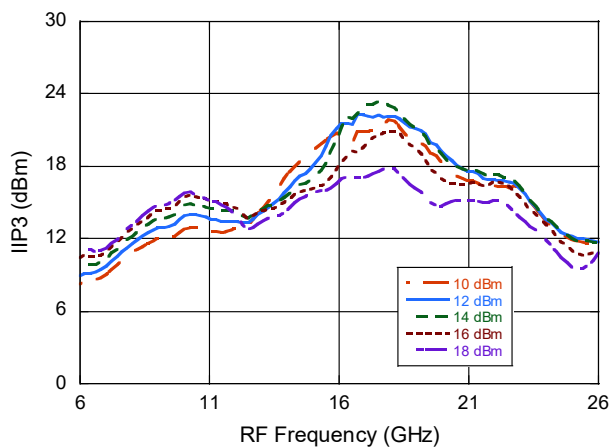

IIP2 over LO drive

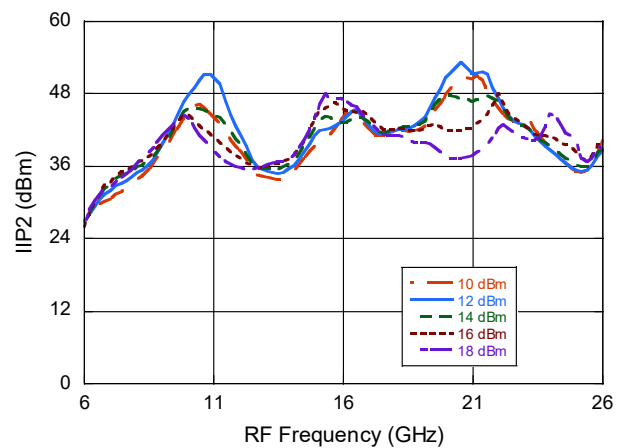

Image Reject Mixer

8 - 26 GHz



MAMX-011075

Rev. V2

Typical Performance Curves: Upper Side Band (USB), Low Side LO

Data captured with 90° Hybrid @ 2 GHz IF

Down Conversion Gain over LO drive

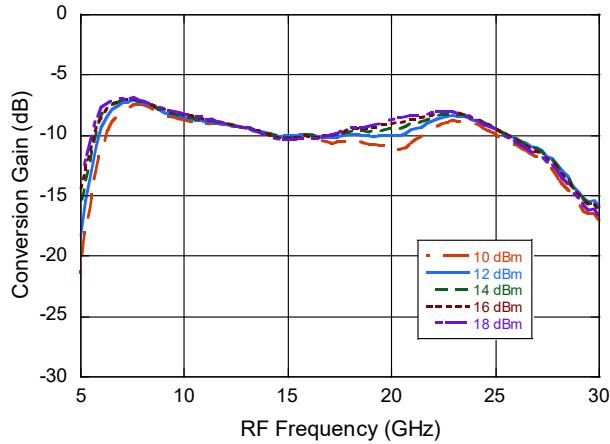

Down Conversion Image Rejection over LO drive

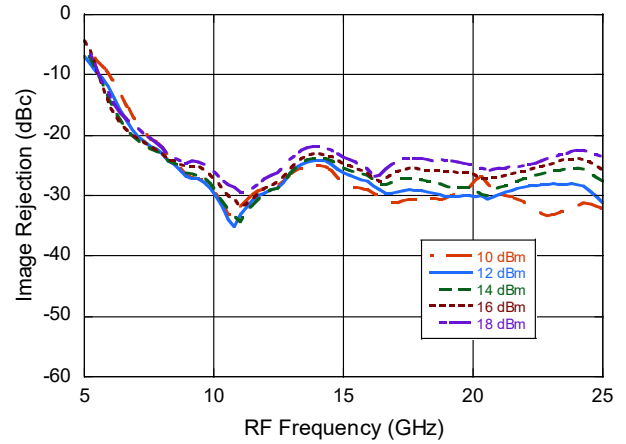

IIP3 over LO drive

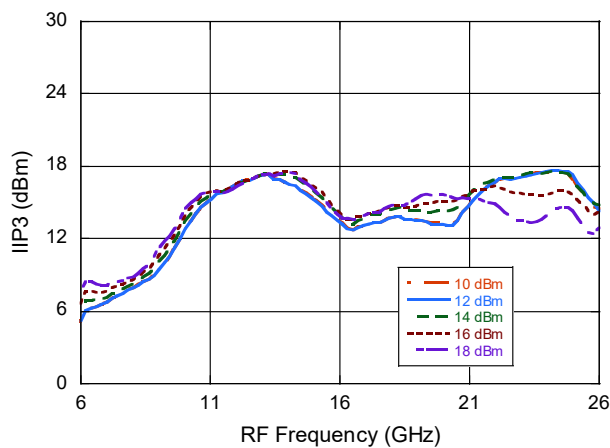

IIP2 over LO drive

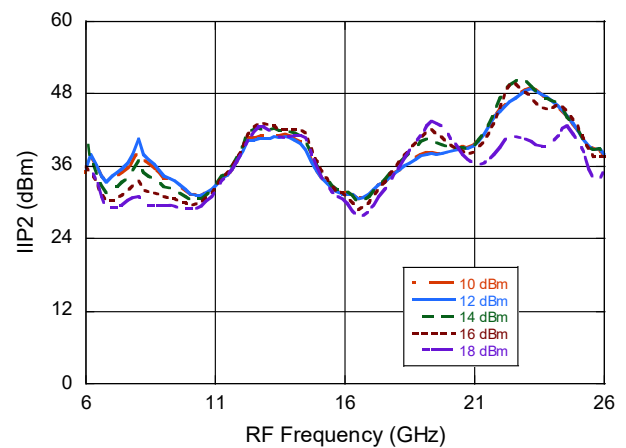

Typical Performance Curves

Isolations

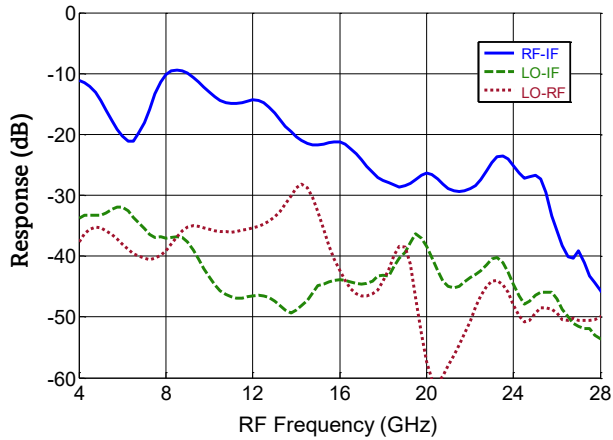

IF Bandwidth

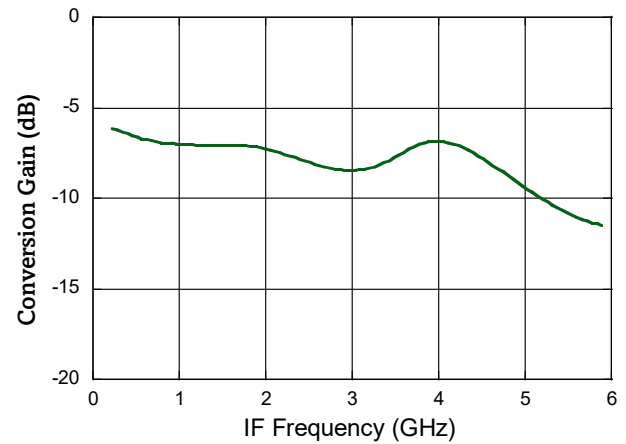

RF Return Loss

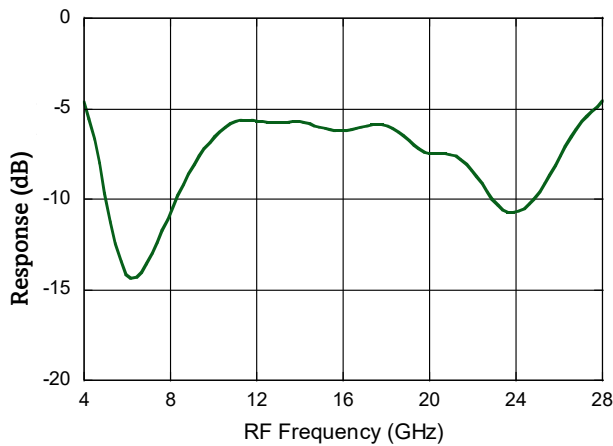

P1dB vs LO power

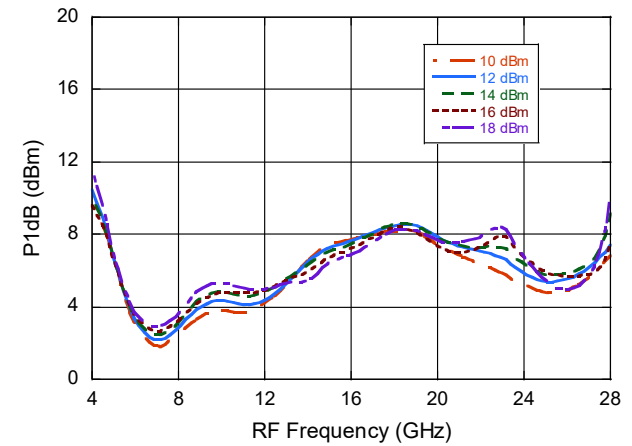

IF Return Loss

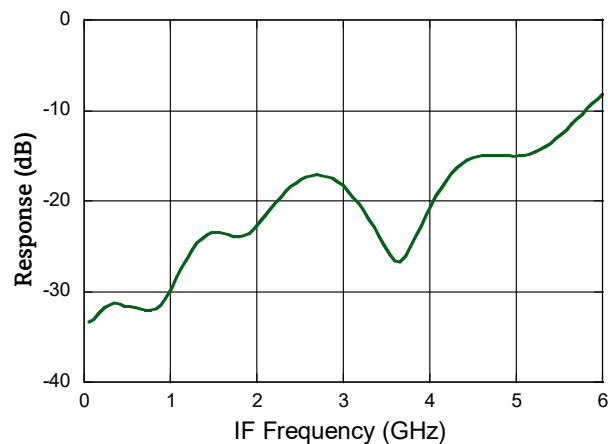

Image Reject Mixer

8 - 26 GHz



MAMX-011075
Rev. V2

MxN Spurious Rejection @ IF port

RF 15.9 GHz @ -10 dBm, LO 16.0 GHz @ +14 dBm
All values in dBc below the IF output level

mxRF	nxLO				
	0	1	2	3	4
0	x	6	18	30	x
1	17	0	43	43	44
2	70	60	46	61	73
3	80	x	90	66	83
4	x	x	x	102	80

LO Harmonics

LO +14 dBm
Values in dBc below input LO level measured at RF

LO GHz	n LO spur at RF port			
	1	2	3	4
6	38	47	61	49
8	42	55	50	61
10	38	58	52	50
12	38	55	82	46
14	31	52	50	N/A
16	43	58	48	N/A
18	44	82	N/A	N/A
20	57	54	N/A	N/A
22	51	52	N/A	N/A
24	52	58	N/A	N/A
26	54	N/A	N/A	N/A

Application Schematic

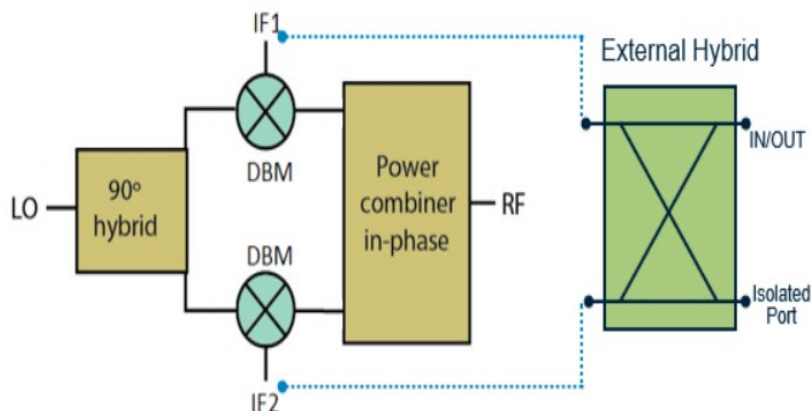

External Hybrid

- Down conversion and Up conversion data captured with external hybrid 90° coupler part number: Innovative IPP-2345.
- RF Upper Side Band (USB) mode connect hybrid 0° port to IF1 mixer port, 90° hybrid port to IF2 mixer port.
- RF Lower Side Band (LSB) mode connect hybrid 0° port to IF2 mixer port, 90° hybrid port to IF1 mixer port.

Image Reject Mixer 8 - 26 GHz



MAMX-011075

Rev. V2

Sample Board

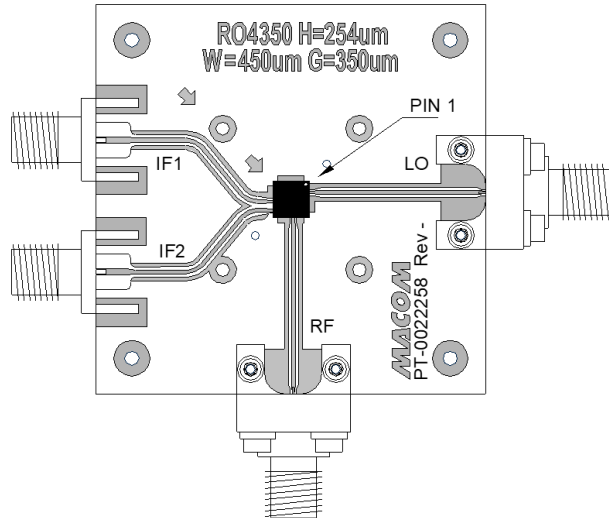

- Material: Rogers 4350B
- Dielectric thickness 0.254 mm
- Finished copper thickness 17 microns (0.5 oz) plated to 44 microns +/- 10 microns
- Finish both sides: ENIG, 0.05-0.15 μm gold over 3-6 μm nickel
- DXF available on request

Evaluation Board Losses

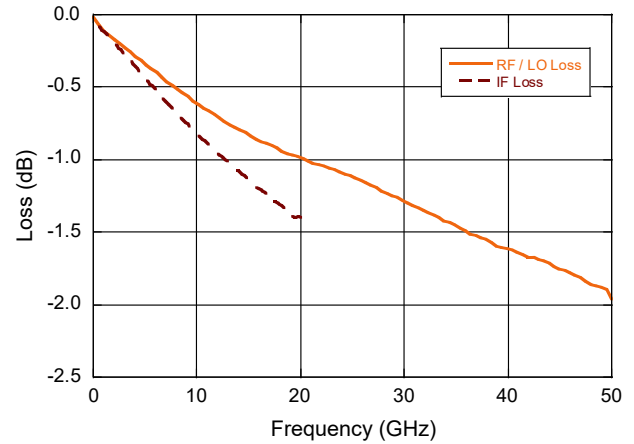

Image Reject Mixer

8 - 26 GHz



MAMX-011075

Rev. V2

Lead-Free 4 mm 24-Lead AQFN Package

