

### Features

- MACOM PURE CARBIDE™ Amplifier Series
- Suitable for Linear & Saturated Applications
- Pulsed Operation: 1300 W Output Power @ 65 V
- 1000 W Output Power @ 50 V
- Internally Pre-Matched
- 260°C Reflow Compatible
- 65 V Operation
- 100% RF Tested
- RoHS\* Compliant
- Compatible with MACOM Power Management Bias Controller/Sequencer MABC-11040

### Applications

- Avionics, IFF Transponders.

### Description

The MAPC-A1501 is a high power GaN on Silicon Carbide HEMT D-mode amplifier suitable for 960 - 1215 MHz frequency operation. The device supports pulsed operation with output power levels of 1300 W (61.1 dBm) at 65V and 1000 W (60.0 dBm) at 50V and in an air cavity ceramic package.

### Typical Performance:

Measured under load-pull at 2.5 dB Compression, 100 µs pulse width, 1% duty cycle.

- $V_{DS} = 65 \text{ V}$ ,  $I_{DQ} = 650 \text{ mA}$ ,  $T_C = 25^\circ\text{C}$ .

Frequency (MHz)	Output Power <sup>1</sup> (dBm)	Gain <sup>2</sup> (dB)	$\eta_D$ <sup>2</sup> (%)
960	62.4	20.8	76.1
1030	62.2	20.4	73.1
1090	62.1	20.4	73.1
1215	61.9	18.8	71.0

- $V_{DS} = 50 \text{ V}$ ,  $I_{DQ} = 650 \text{ mA}$ ,  $T_C = 25^\circ\text{C}$ .

Frequency (MHz)	Output Power <sup>1</sup> (dBm)	Gain <sup>2</sup> (dB)	$\eta_D$ <sup>2</sup> (%)
960	61.1	19.9	71.2
1030	60.8	19.6	70.4
1090	60.7	19.1	70.7
1215	60.7	18.4	71.3

1. Load impedance tuned for maximum output power.
2. Load impedance tuned for maximum drain efficiency.



AC-780B-2



AC-780S-2

### Functional Schematic

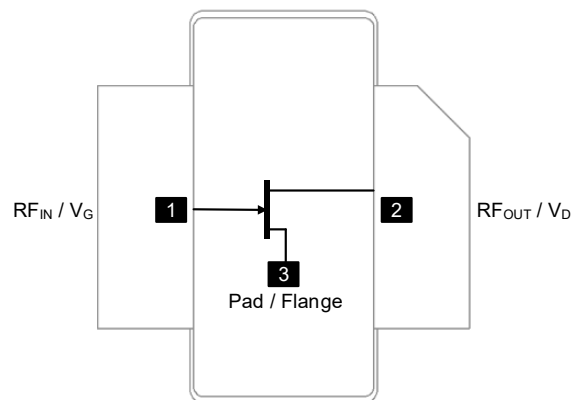

### Pin Configuration

Pin #	Pin Name	Function
1	RF <sub>IN</sub> / V <sub>G</sub>	RF Input / Gate
2	RF <sub>OUT</sub> / V <sub>D</sub>	RF Output / Drain
3	Flange <sup>3</sup>	Ground / Source

3. The flange on the package bottom must be connected to RF, DC and thermal ground.

### Ordering Information

Part Number	Package
MAPC-A1501-AS000	Bulk Quantity Earless
MAPC-A1501-ASTR1	Tape and Reel Earless
MAPC-A1501-ASSB1	Sample Board Earless
MAPC-A1501-AB000	Bulk Quantity Boltdown
MAPC-A1501-ABTR1	Tape and Reel Boltdown
MAPC-A1501-ABSB1	Sample Board Boltdown

<sup>1</sup> \* Restrictions on Hazardous Substances, compliant to current RoHS EU directive.

**RF Electrical Characteristics:  $T_C = 25^\circ\text{C}$ ,  $V_{DS} = 65\text{ V}$ ,  $I_{DQ} = 650\text{ mA}$**

**Note: Performance in MACOM 1030 - 1090 MHz Evaluation Test Fixture, 50  $\Omega$  system**

Parameter	Test Conditions	Symbol	Min.	Typ.	Max.	Units
Small Signal Gain	Pulsed <sup>4</sup> , 1.06 GHz	$G_{SS}$	-	18.0	-	dB
Saturated Output Power	Pulsed <sup>4</sup> , 1.06 GHz, 2.5 dB Gain Compression	$P_{SAT}$	-	61.8	-	dBm
Power Gain	Pulsed <sup>4</sup> , 1.06 GHz, 2.5 dB Gain Compression	$G_{SAT}$	-	18.2	-	dB
Saturated Drain Efficiency	Pulsed <sup>4</sup> , 1.06 GHz, 2.5 dB Gain Compression	$\eta_{SAT}$	-	69.5	-	%
Gain Variation (-40°C to +85°C)	Pulsed <sup>4</sup> , 1.06 GHz	$\Delta G$	-	0.012	-	dB/°C
Power Variation (-40°C to +85°C)	Pulsed <sup>4</sup> , 1.06 GHz	$\Delta P_{2.5dB}$	-	0.003	-	dB/°C
Power Gain	Pulsed <sup>4</sup> , 1.06 GHz, $P_{OUT} = 61\text{ dBm}$	$G_P$	-	20	-	dB
Drain Efficiency	Pulsed <sup>4</sup> , 1.06 GHz, $P_{OUT} = 61\text{ dBm}$	$\eta$	-	64.5	-	%
Input Return Loss	Pulsed <sup>4</sup> , 1.06 GHz, $P_{OUT} = 61\text{ dBm}$	IRL	-	-15	-	dB
Ruggedness: Output Mismatch	All phase angles	$\Psi$	VSWR = 7:1, No Damage			

**RF Electrical Characteristics:  $T_C = 25^\circ\text{C}$ ,  $V_{DS} = 50\text{ V}$ ,  $I_{DQ} = 650\text{ mA}$**

**Note: Performance in MACOM 1030 - 1090 MHz Evaluation Test Fixture, 50  $\Omega$  system**

Parameter	Test Conditions	Symbol	Min.	Typ.	Max.	Units
Small Signal Gain	Pulsed <sup>4</sup> , 1.06 GHz	$G_{SS}$	-	17.2	-	dB
Saturated Output Power	Pulsed <sup>4</sup> , 1.06 GHz, 2.5 dB Gain Compression	$P_{SAT}$	-	60.3	-	dBm
Power Gain	Pulsed <sup>4</sup> , 1.06 GHz, 2.5 dB Gain Compression	$G_{SAT}$	-	17.2	-	dB
Saturated Drain Efficiency	Pulsed <sup>4</sup> , 1.06 GHz, 2.5 dB Gain Compression	$\eta_{SAT}$	-	64.5	-	%
Gain Variation (-40°C to +85°C)	Pulsed <sup>4</sup> , 1.06 GHz	$\Delta G$	-	0.021	-	dB/°C
Power Variation (-40°C to +85°C)	Pulsed <sup>4</sup> , 1.06 GHz	$\Delta P_{2.5dB}$	-	0.005	-	dB/°C
Power Gain	Pulsed <sup>4</sup> , 1.06 GHz, $P_{OUT} = 61\text{ dBm}$	$G_P$	-	18.2	-	dB
Drain Efficiency	Pulsed <sup>4</sup> , 1.06 GHz, $P_{OUT} = 61\text{ dBm}$	$\eta$	-	62.5	-	%
Input Return Loss	Pulsed <sup>4</sup> , 1.06 GHz, $P_{OUT} = 61\text{ dBm}$	IRL	-	-15	-	dB
Ruggedness: Output Mismatch	All phase angles	$\Psi$	VSWR = 7:1, No Damage			

**RF Electrical Specifications:  $T_A = 25^\circ\text{C}$ ,  $V_{DS} = 65\text{ V}$ ,  $I_{DQ} = 650\text{ mA}$**

**Note: Performance in MACOM 1030 - 1090 MHz Production Test Fixture, 50  $\Omega$  system**

Parameter	Test Conditions	Symbol	Min.	Typ.	Max.	Units
Power Gain	Pulsed <sup>4</sup> , 1.06 GHz, 2.5 dB Gain Compression	$G_{SAT}$	17	18.1	-	dB
Saturated Drain Efficiency	Pulsed <sup>4</sup> , 1.06 GHz, 2.5 dB Gain Compression	$\eta_{SAT}$	62	69.5	-	%
Saturated Output Power	Pulsed <sup>4</sup> , 1.06 GHz, 2.5 dB Gain Compression	$P_{SAT}$	60.4	61.8	-	dBm

4. Pulse details: 100  $\mu\text{s}$  pulse width, 1% Duty Cycle.

**DC Electrical Characteristics  $T_A = 25^\circ\text{C}$**

Parameter	Test Conditions	Symbol	Min.	Typ.	Max.	Units
Drain-Source Leakage Current	$V_{GS} = -8\text{ V}$ , $V_{DS} = 130\text{ V}$	$I_{DLK}$	-	-	133	mA
Gate-Source Leakage Current	$V_{GS} = -8\text{ V}$ , $V_{DS} = 0\text{ V}$	$I_{GLK}$	-	-	133	mA
Gate Threshold Voltage	$V_{DS} = 50\text{ V}$ , $I_D = 133\text{ mA}$	$V_T$	-3.6	-3.1	-	V
Gate Quiescent Voltage	$V_{DS} = 50\text{ V}$ , $I_D = 650\text{ mA}$	$V_{GSQ}$	-	-2.71	-	V
On Resistance	$V_{GS} = 2\text{ V}$ , $I_D = 1000\text{ mA}$	$R_{ON}$	-	0.026	-	$\Omega$
Maximum Drain Current	$V_{DS} = 7\text{ V}$ pulsed, pulse width 300 $\mu\text{s}$	$I_{D, MAX}$	-	126	-	A

**Absolute Maximum Ratings** <sup>5,6,7,8,9</sup>

Parameter	Absolute Maximum
Drain Source Voltage, $V_{DS}$	130 V
Gate Source Voltage, $V_{GS}$	-10 to 3 V
Gate Current, $I_G$	133 mA
Storage Temperature Range	-65°C to +150°C
Case Operating Temperature Range	-40°C to +85°C
Channel Operating Temperature Range, $T_{CH}$	-40°C to +225°C
Absolute Maximum Channel Temperature	+250°C

5. Exceeding any one or combination of these limits may cause permanent damage to this device.
6. MACOM does not recommend sustained operation above maximum operating conditions.
7. Operating at drain source voltage  $V_{DS} < 55$  V will ensure  $MTTF > 2 \times 10^6$  hours.
8. Operating at nominal conditions with  $T_{CH} \leq 200^\circ\text{C}$  will ensure  $MTTF > 2 \times 10^6$  hours.
9. MTTF may be estimated by the expression  $MTTF$  (hours) =  $A e^{[B + C/(T+273)]}$  where  $T$  is the channel temperature in degrees Celsius,  $A = 1$ ,  $B = -38.215$ , and  $C = 26,343$ .

**Thermal Characteristics**<sup>10</sup>

Parameter	Test Conditions	Symbol	Typical	Units
Thermal Resistance using Finite Element Analysis (Pulsed: 100µs, 10%)	$V_{DS} = 65$ V, $T_C = 85^\circ\text{C}$ , $T_{CH} = 225^\circ\text{C}$	$R_{\theta}(\text{FEA})$	0.16	°C/W
Thermal Resistance using Infrared Measurement of Die Surface Temperature	$V_{DS} = 65$ V, $T_C = 85^\circ\text{C}$ , $T_{CH} = 225^\circ\text{C}$	$R_{\theta}(\text{IR})$	0.15	°C/W

10. Case temperature measured using thermocouple embedded in heat-sink. Contact local applications support team for more details on this measurement.

**Handling Procedures**

Please observe the following precautions to avoid damage:

**Static Sensitivity**

Gallium Nitride Circuits are sensitive to electrostatic discharge (ESD) and can be damaged by static electricity. Proper ESD control techniques should be used when handling these devices.

**65V Pulsed<sup>13</sup> Load-Pull Performance  
Reference Plane at Device Leads**

Frequency (MHz)	Z <sub>SOURCE</sub> (Ω)	Maximum Output Power					
		V <sub>DS</sub> = 65 V, I <sub>DQ</sub> = 650 mA, T <sub>C</sub> = 25°C, P2.5dB					
		Z <sub>LOAD</sub> <sup>11</sup> (Ω)	Gain (dB)	P <sub>OUT</sub> (dBm)	P <sub>OUT</sub> (W)	η <sub>D</sub> (%)	AM/PM (°)
960	1.1 - j2.0	0.73 - j0.55	19.6	62.4	1740	65.8	32
1030	2.3 - j1.8	0.68 - j0.61	19.0	62.2	1660	62.5	-3
1090	2.6 - j0.8	0.64 - j0.62	18.7	62.1	1620	62.2	-32
1215	1.3 + j0.1	0.62 - j0.73	18.2	61.9	1550	63.7	-81

Frequency (MHz)	Z <sub>SOURCE</sub> (Ω)	Maximum Drain Efficiency					
		V <sub>DS</sub> = 65 V, I <sub>DQ</sub> = 650 mA, T <sub>C</sub> = 25°C, P2.5dB					
		Z <sub>LOAD</sub> <sup>12</sup> (Ω)	Gain (dB)	P <sub>OUT</sub> (dBm)	P <sub>OUT</sub> (W)	η <sub>D</sub> (%)	AM/PM (°)
960	1.1 - j2.2	0.85 + j0.24	20.8	60.0	1000	76.1	14
1030	2.6 - j1.5	0.87 + j0.08	20.4	60.0	1000	73.1	-30
1090	2.5 - j0.1	0.86 + j0.0	20.4	59.5	890	73.1	-69
1215	1.0 + j0.0	0.77 - j0.12	18.8	59.5	890	71.0	-106

**Impedance Reference**

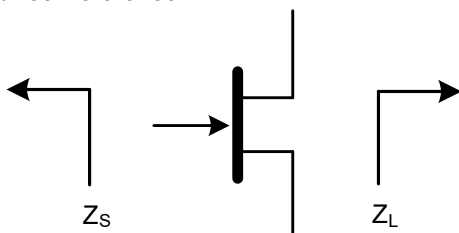

Z<sub>SOURCE</sub> = Measured impedance presented to the input of the device at package reference plane.

Z<sub>LOAD</sub> = Measured impedance presented to the output of the device at package reference plane.

- 11. Load Impedance for optimum output power.
- 12. Load Impedance for optimum efficiency.
- 13. Pulse Details: 15μs pulse width, 1% duty cycle

65V Pulsed<sup>13</sup> Load-Pull Performance  
1090 MHz

P2.5dB Loadpull Output Power Contours (dBm)

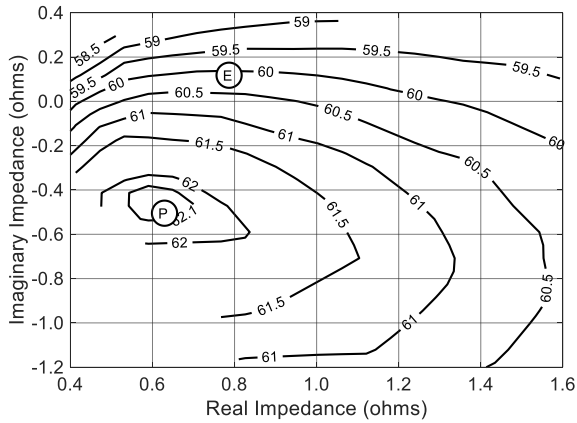

P2.5dB Loadpull Drain Efficiency Contours (%)

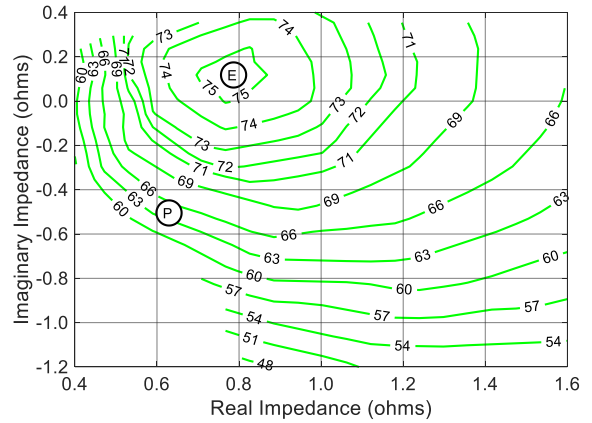

P2.5dB Loadpull Gain Contours (dB)

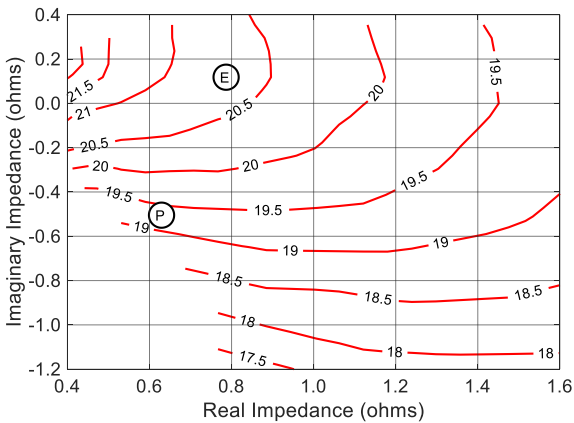

P2.5dB Loadpull AM/PM Contours (°)

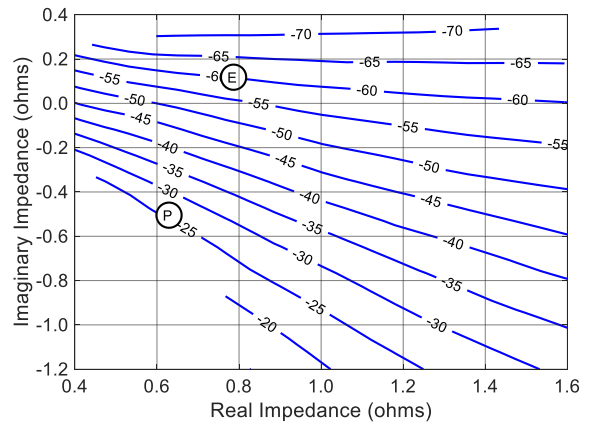

Gain vs. Output Power

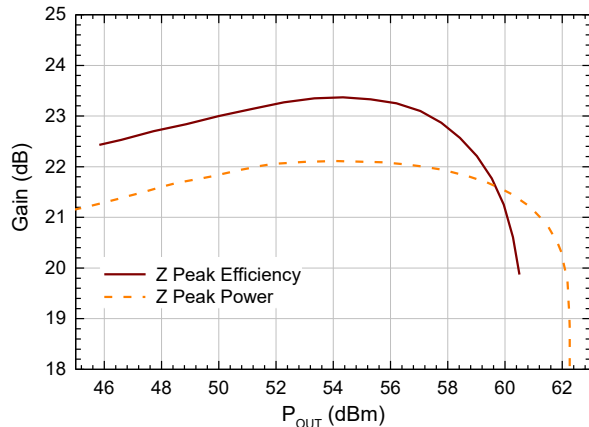

Drain Efficiency vs. Output Power

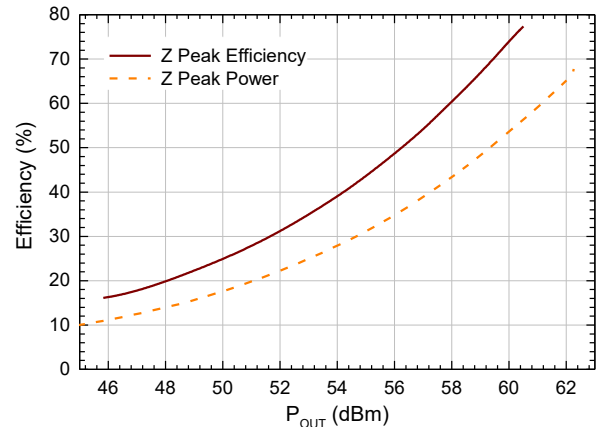

**50V Pulsed<sup>13</sup> Load-Pull Performance**  
Reference Plane at Device Leads

Frequency (MHz)	$Z_{SOURCE}$ ( $\Omega$ )	Maximum Output Power					
		$V_{DS} = 50\text{ V}, I_{DQ} = 650\text{ mA}, T_C = 25^\circ\text{C}, P_{2.5dB}$					
		$Z_{LOAD}^{11}$ ( $\Omega$ )	Gain (dB)	$P_{OUT}$ (dBm)	$P_{OUT}$ (W)	$\eta_D$ (%)	AM/PM ( $^\circ$ )
960	1.2 - j2.2	0.55 - j0.54	19.1	61.1	1290	62.6	35
1030	2.6 - j1.2	0.54 - j0.81	18.4	60.8	1200	60.8	0
1090	2.5 + j0.3	0.49 - j0.80	18.4	60.7	1175	60.8	-32
1215	1.1 - j0.1	0.47 - j0.93	17.7	60.7	1175	59.7	-78

Frequency (MHz)	$Z_{SOURCE}$ ( $\Omega$ )	Maximum Drain Efficiency					
		$V_{DS} = 50\text{ V}, I_{DQ} = 650\text{ mA}, T_C = 25^\circ\text{C}, P_{2.5dB}$					
		$Z_{LOAD}^{12}$ ( $\Omega$ )	Gain (dB)	$P_{OUT}$ (dBm)	$P_{OUT}$ (W)	$\eta_D$ (%)	AM/PM ( $^\circ$ )
960	1.2 - j2.2	0.91 + j0.07	19.9	58.5	710	71.2	7
1030	2.6 - j1.2	0.78 - j0.16	19.6	58.5	710	70.4	-36
1090	2.5 + j0.3	0.77 - j0.23	19.1	58.4	690	70.7	-69
1215	1.1 - j0.1	0.68 - j0.38	18.4	58.4	690	71.3	-106

**Impedance Reference**

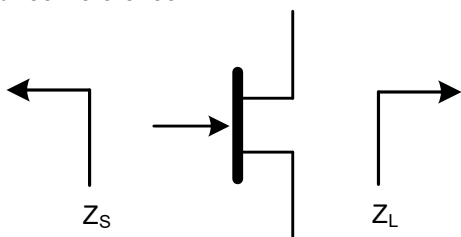

$Z_{SOURCE}$  = Measured impedance presented to the input of the device at package reference plane.  
 $Z_{LOAD}$  = Measured impedance presented to the output of the device at package reference plane.

- 11. Load Impedance for optimum output power.
- 12. Load Impedance for optimum efficiency.

50V Pulsed<sup>13</sup> Load-Pull Performance  
1090 MHz

P2.5dB Loadpull Output Power Contours (dBm)

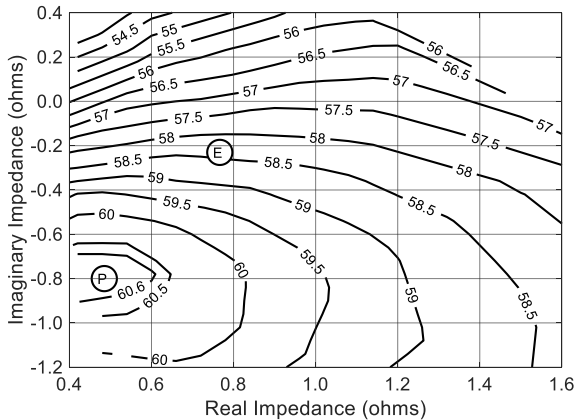

P2.5dB Loadpull Drain Efficiency Contours (%)

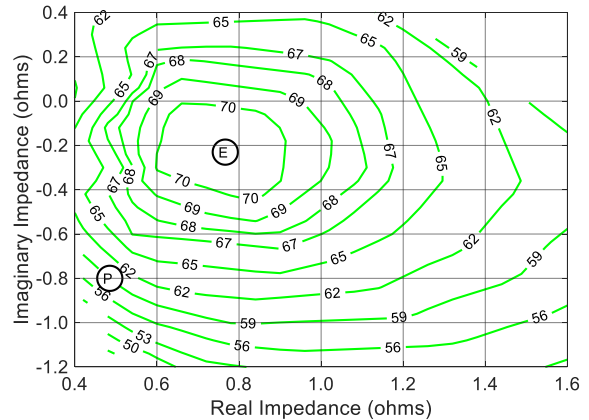

P2.5dB Loadpull Gain Contours (dB)

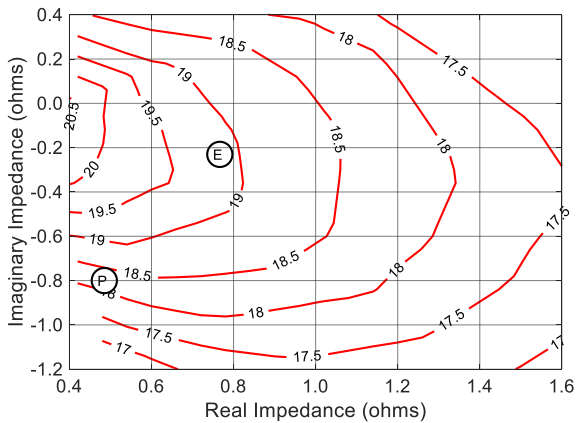

P2.5dB Loadpull AM/PM Contours (°)

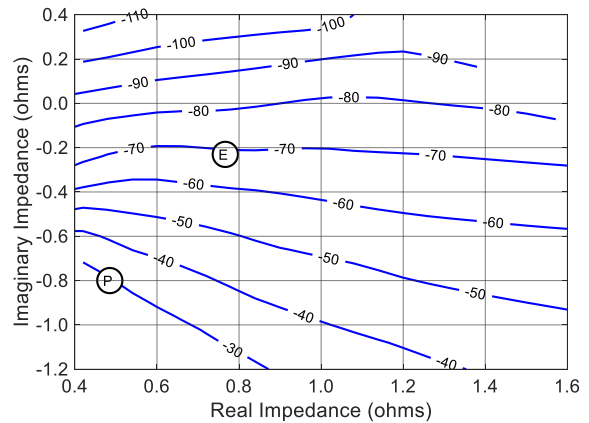

Gain vs. Output Power

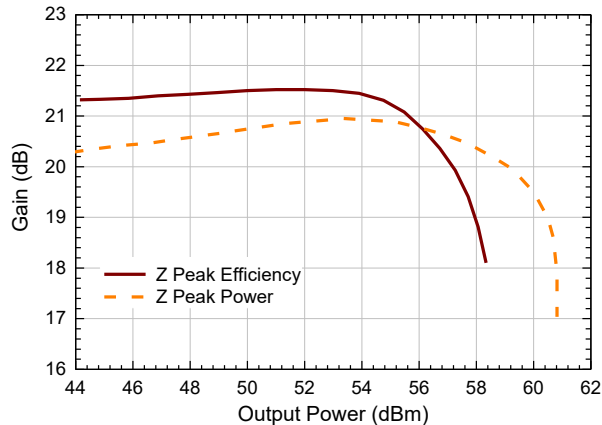

Drain Efficiency vs. Output Power

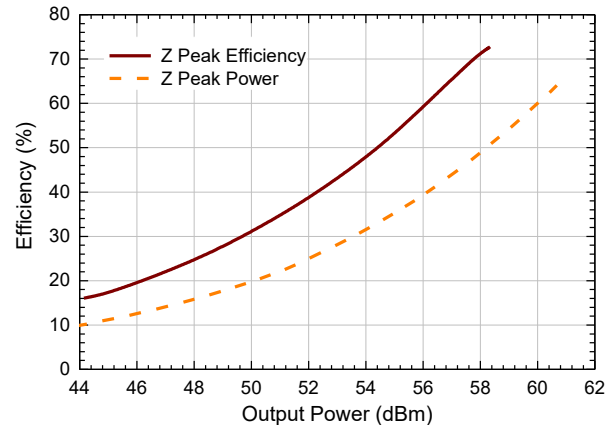



28V Pulsed<sup>14</sup> Load-Pull Performance  
Reference Plane at Device Leads

Frequency (MHz)	Z <sub>SOURCE</sub> (Ω)	Maximum Output Power					
		V <sub>DS</sub> = 28 V, I <sub>DQ</sub> = 650 mA, T <sub>C</sub> = 25°C, P2.5dB					
		Z <sub>LOAD</sub> <sup>11</sup> (Ω)	Gain (dB)	P <sub>OUT</sub> (dBm)	P <sub>OUT</sub> (W)	η <sub>D</sub> (%)	AM/PM (°)
960	0.50 - j1.5	0.33 - j0.55	16.1	57.4	554	57.8	-0.2
1030	1.1 - j1.8	0.28 - j0.61	16.4	57.8	607	58.6	-2.6
1090	1.6 + j1.9	0.27 - j0.65	16.0	57.5	567	57.3	-5.0
1215	2.0 - j0.5	0.28 - j0.75	15.6	57.4	550	60.6	-7.8

Frequency (MHz)	Z <sub>SOURCE</sub> (Ω)	Maximum Drain Efficiency					
		V <sub>DS</sub> = 28 V, I <sub>DQ</sub> = 650 mA, T <sub>C</sub> = 25°C, P2.5dB					
		Z <sub>LOAD</sub> <sup>12</sup> (Ω)	Gain (dB)	P <sub>OUT</sub> (dBm)	P <sub>OUT</sub> (W)	η <sub>D</sub> (%)	AM/PM (°)
960	0.50 - j1.5	0.62 - j0.20	17.2	54.8	301	68.3	-7.3
1030	1.1 - j1.8	0.60 - j0.17	16.9	54.5	280	70.8	-12.8
1090	1.6 + j1.9	0.54 - j0.29	16.7	54.3	268	69.3	-21.3
1215	2.0 - j0.5	0.50 - j0.36	16.0	54.5	282	71.6	-10.7

Impedance Reference

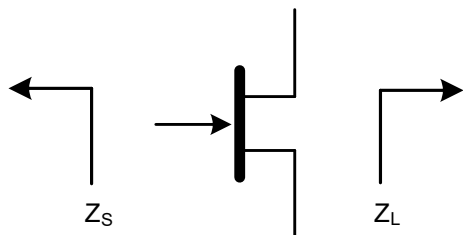

Z<sub>SOURCE</sub> = Measured impedance presented to the input of the device at package reference plane.

Z<sub>LOAD</sub> = Measured impedance presented to the output of the device at package reference plane.

- 11. Load Impedance for optimum output power.
- 12. Load Impedance for optimum efficiency.
- 14. Pulse Details: 50µs pulse width, 1% duty cycle

**Evaluation Test Fixture and Recommended Tuning Solution 1.03-1.09 GHz**

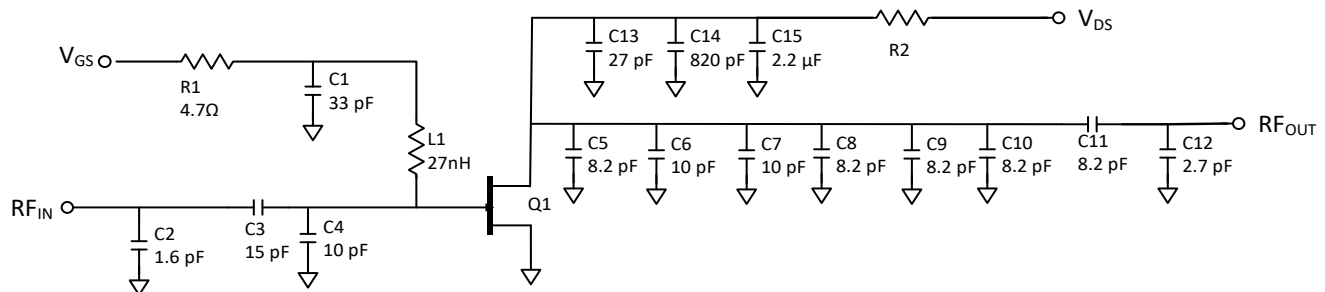

**Description**

Parts measured on evaluation board (20-mil thick RO4350). Matching is provided using a combination of lumped elements and transmission lines as shown in the simplified schematic above. Recommended tuning solution component placement, transmission lines, and details are shown on the next page.

**Bias Sequencing\***

**Turning the device ON**

1. Set  $V_{GS}$  to pinch-off ( $V_P$ ).
2. Turn on  $V_{DS}$  to nominal voltage (50 V).
3. Increase  $V_{GS}$  until  $I_{DS}$  current is reached.
4. Apply RF power to desired level.

**Turning the device OFF**

1. Turn the RF power OFF.
2. Decrease  $V_{GS}$  down to  $V_P$  pinch-off.
3. Decrease  $V_{DS}$  down to 0 V.
4. Turn off  $V_{GS}$ .

\* For an integrated power management solution please contact MACOM support regarding the MABC-11040.

**Evaluation Test Fixture and Recommended Tuning Solution 1.03 - 1.09 GHz**

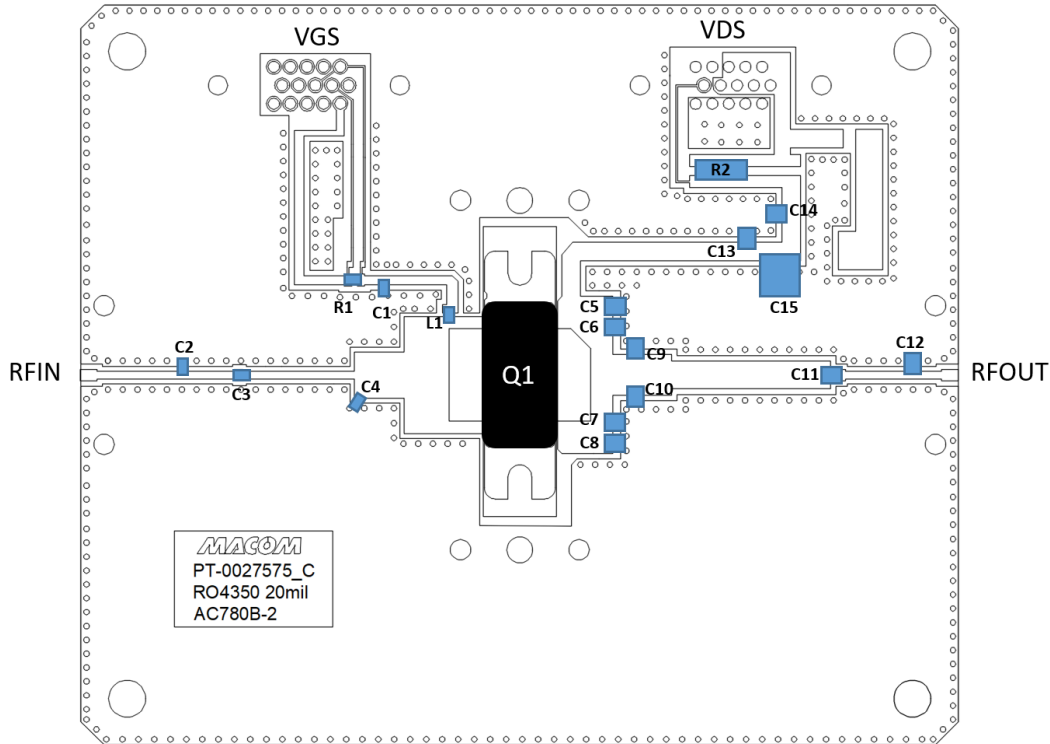

Reference Designator	Value	Tolerance	Manufacturer	Part Number
C1	33 pF	± 5 %	Murata	GQM2195C2E330JB02
C2	1.6 pF	± 0.1 pF	Murata	GQM2195C2E1P6BB12
C3	15 pF	± 5 %	Murata	GQM2195C2E150JB02
C4	10 pF	± 5 %	Murata	GQM2195C2E100JB02
C5, C8, C9, C10, C11	8.2 pF	± 0.1 pF	Murata	GQM22M5C2H8P2JBB01
C6, C7	10 pF	± 5 %	Murata	GQM22M5C2H100JB01
C12	2.7 pF	± 0.1 pF	Murata	GQM22M5C2H2P7BB12
C13	27 pF	± 5 %	Murata	GQM22M5C2H270JB01
C14	820 pF	± 5 %	ATC	800B821JT500XT
C15	2.2 µF	± 10 %	Murata	KRM55TR72E225MH01L
L1	27 nH	± 5 %	CoilCraft	1008CS-270XJL
R1	4.7 Ω	± 1 %	Yageo	RT0805FRE074R7L
R2	0.00 Ω	-	-	Copper jumper
Q1	MACOM GaN Power Amplifier		MAPC-A1501	
PCB	RO4350, 20 mil, 1 oz. Cu, Au Finish			

Typical Performance Curves as Measured in the 1.03 - 1.09 GHz Evaluation Test Fixture:  
Pulsed<sup>4</sup> 1.06 GHz,  $V_{DS} = 50\text{ V}$ ,  $I_{DQ} = 650\text{ mA}$ ,  $T_C = 25^\circ\text{C}$   
Unless Otherwise Noted

Gain vs. Output Power and Frequency

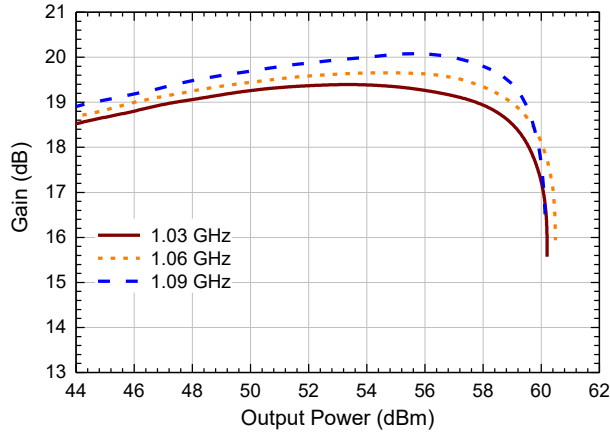

Drain Efficiency vs. Output Power and Frequency

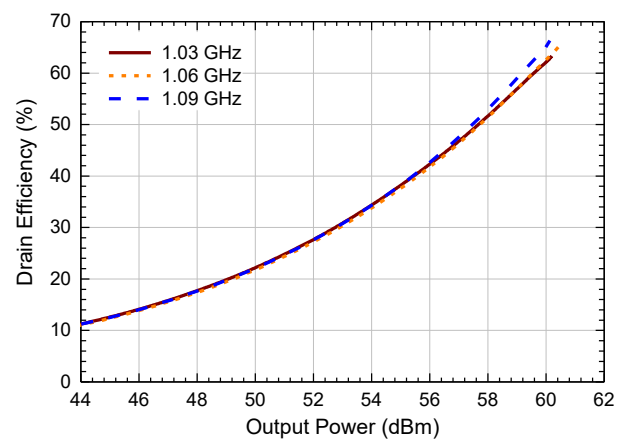

Gain vs. Output Power and  $V_{DS}$

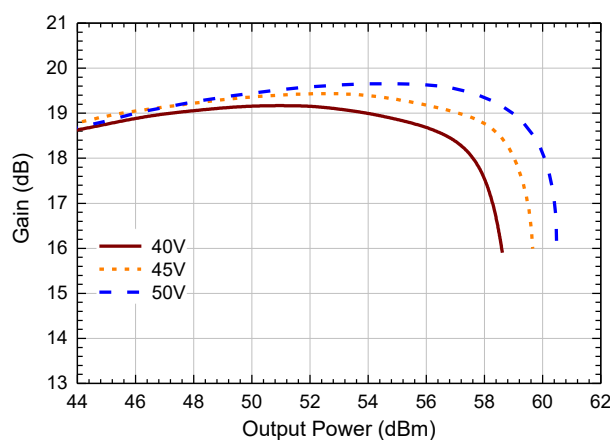

Drain Efficiency vs. Output Power and  $V_{DS}$

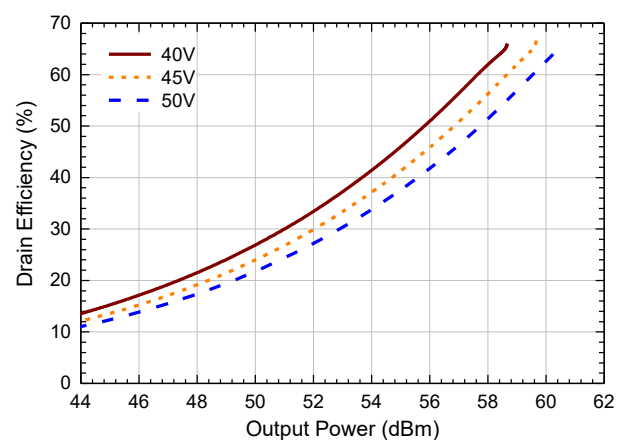

Gain vs. Output Power and  $I_{DQ}$

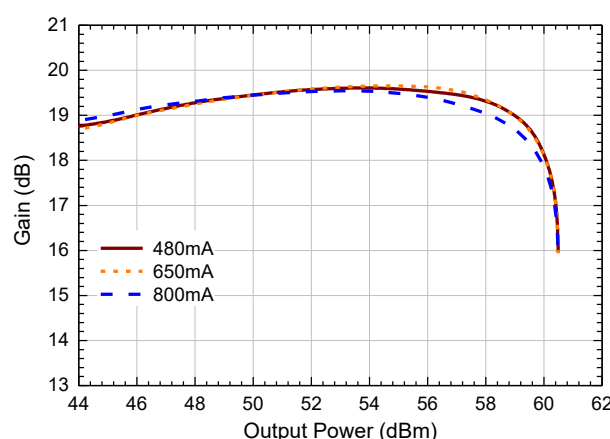

Drain Efficiency vs. Output Power and  $I_{DQ}$

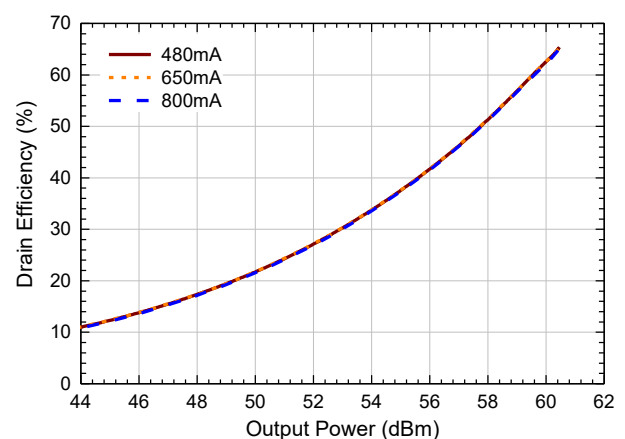

Typical Performance Curves as Measured in the 1.03 - 1.09 GHz Evaluation Test Fixture:  
Pulsed<sup>4</sup> 1.06 GHz,  $V_{DS} = 65\text{ V}$ ,  $I_{DQ} = 650\text{ mA}$ ,  $T_C = 25^\circ\text{C}$   
Unless Otherwise Noted

Gain vs. Output Power and Frequency

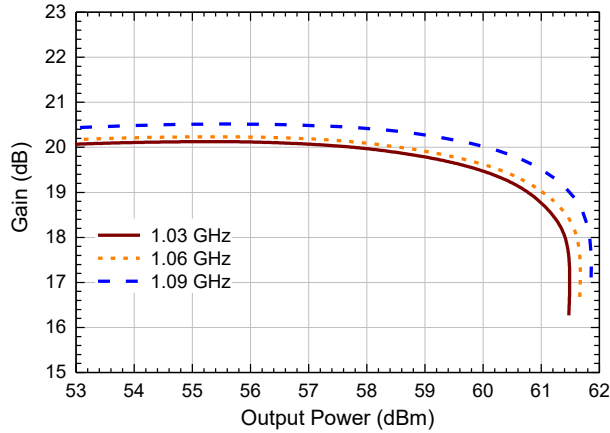

Drain Efficiency vs. Output Power and Frequency

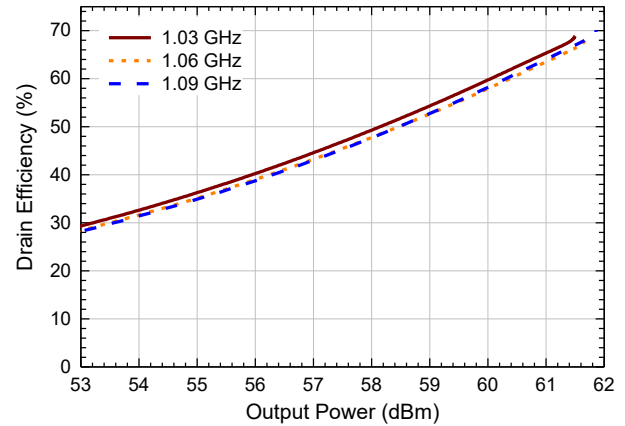

Gain vs. Output Power and  $V_{DS}$

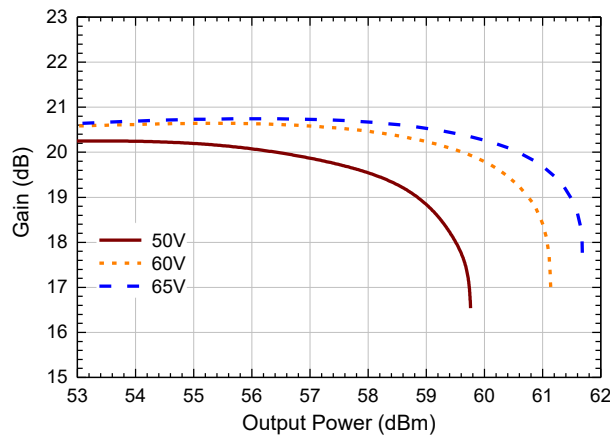

Drain Efficiency vs. Output Power and  $V_{DS}$

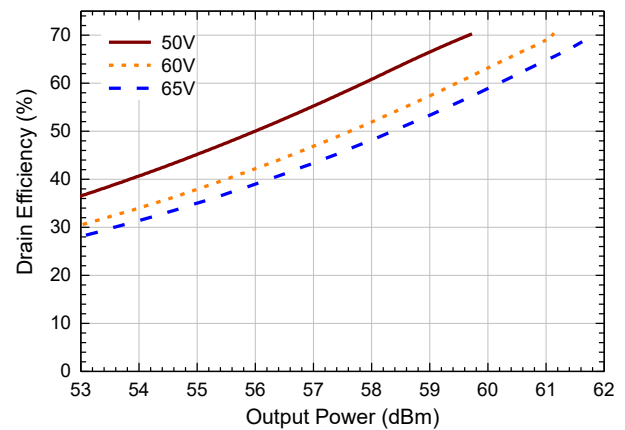

Gain vs. Output Power and  $I_{DQ}$

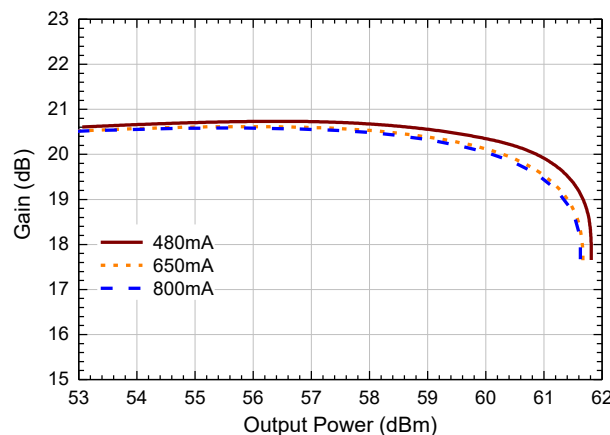

Drain Efficiency vs. Output Power and  $I_{DQ}$

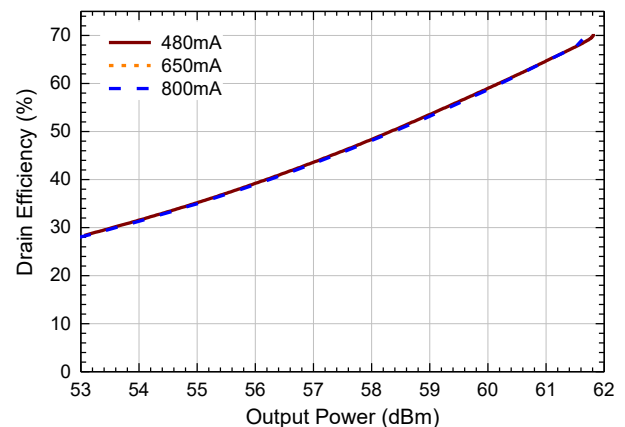

Typical Performance Curves as Measured in the 1.03 - 1.09 GHz Evaluation Test Fixture:  
Pulsed<sup>4</sup> 1.06 GHz,  $V_{DS} = 50$  V,  $I_{DQ} = 650$  mA,  $T_C = 25^\circ\text{C}$   
Unless Otherwise Noted

**Gain vs. Output Power and  $T_C$**

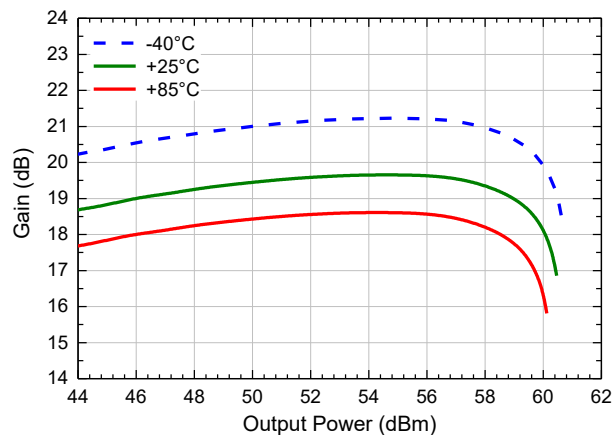

**Drain Efficiency vs. Output Power and  $T_C$**

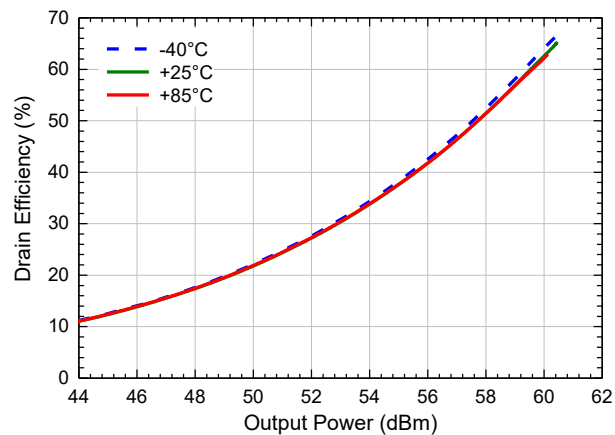

**Gain vs. Frequency, 2.5dB Gain Compression**

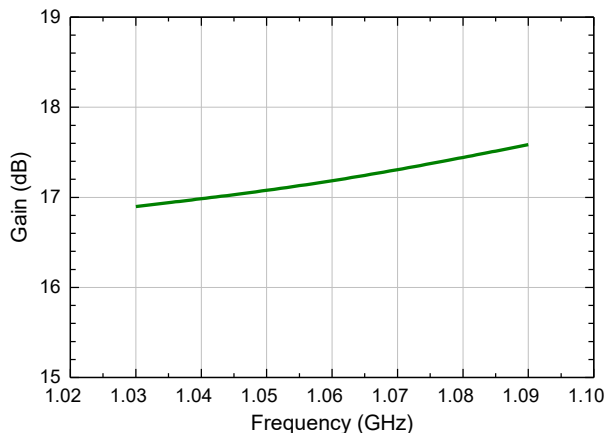

**Drain Efficiency vs. Frequency, 2.5dB Gain Compression**

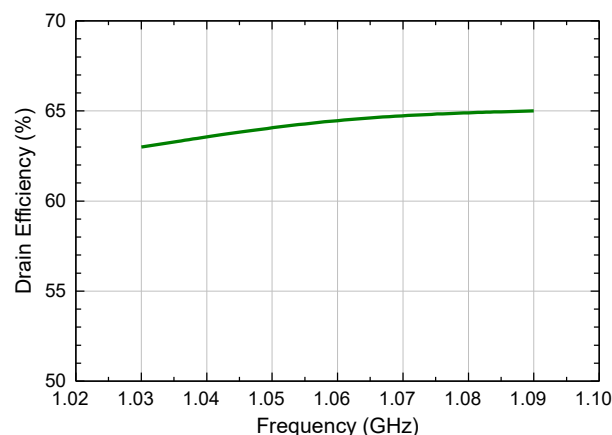

**Output Power vs. Frequency, 2.5dB Gain Compression**

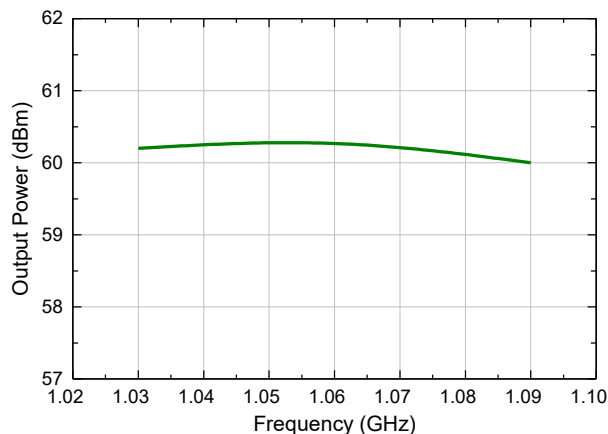

Typical Performance Curves as Measured in the 1.03 - 1.09 GHz Evaluation Test Fixture:  
Pulsed<sup>4</sup> 1.06 GHz,  $V_{DS} = 65\text{ V}$ ,  $I_{DQ} = 650\text{ mA}$ ,  $T_C = 25^\circ\text{C}$   
Unless Otherwise Noted

**Gain vs. Output Power and  $T_C$**

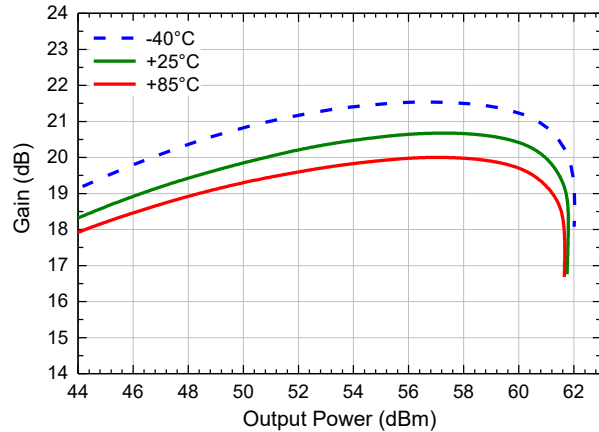

**Drain Efficiency vs. Output Power and  $T_C$**

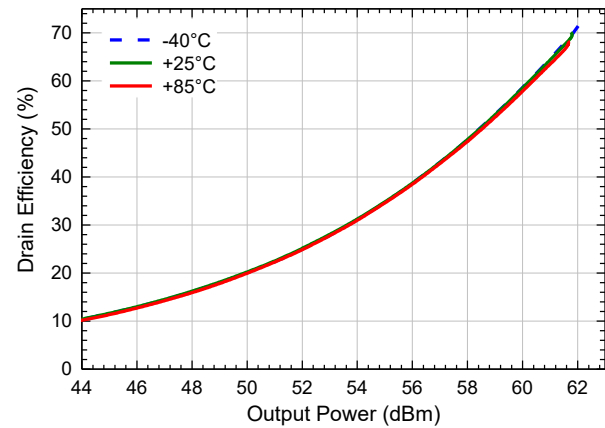

**Gain vs. Frequency, 2.5dB Gain Compression**

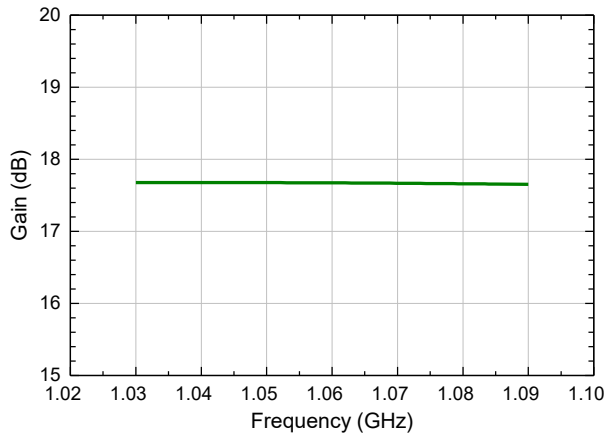

**Drain Efficiency vs. Frequency, 2.5dB Gain Compression**

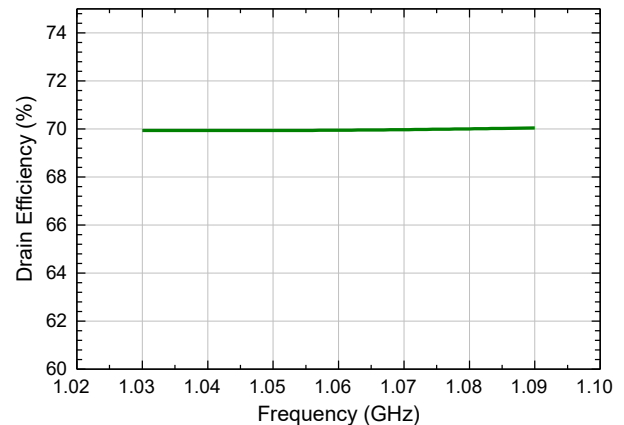

**Output Power vs. Frequency, 2.5dB Gain Compression**

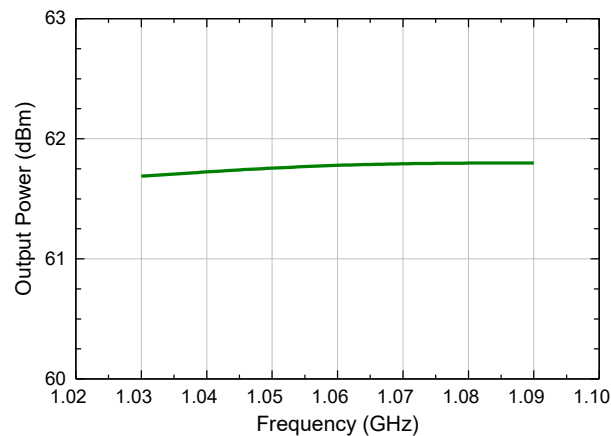

**Lead-Free AC-780B-2 Ceramic Package Dimensions<sup>†</sup>**

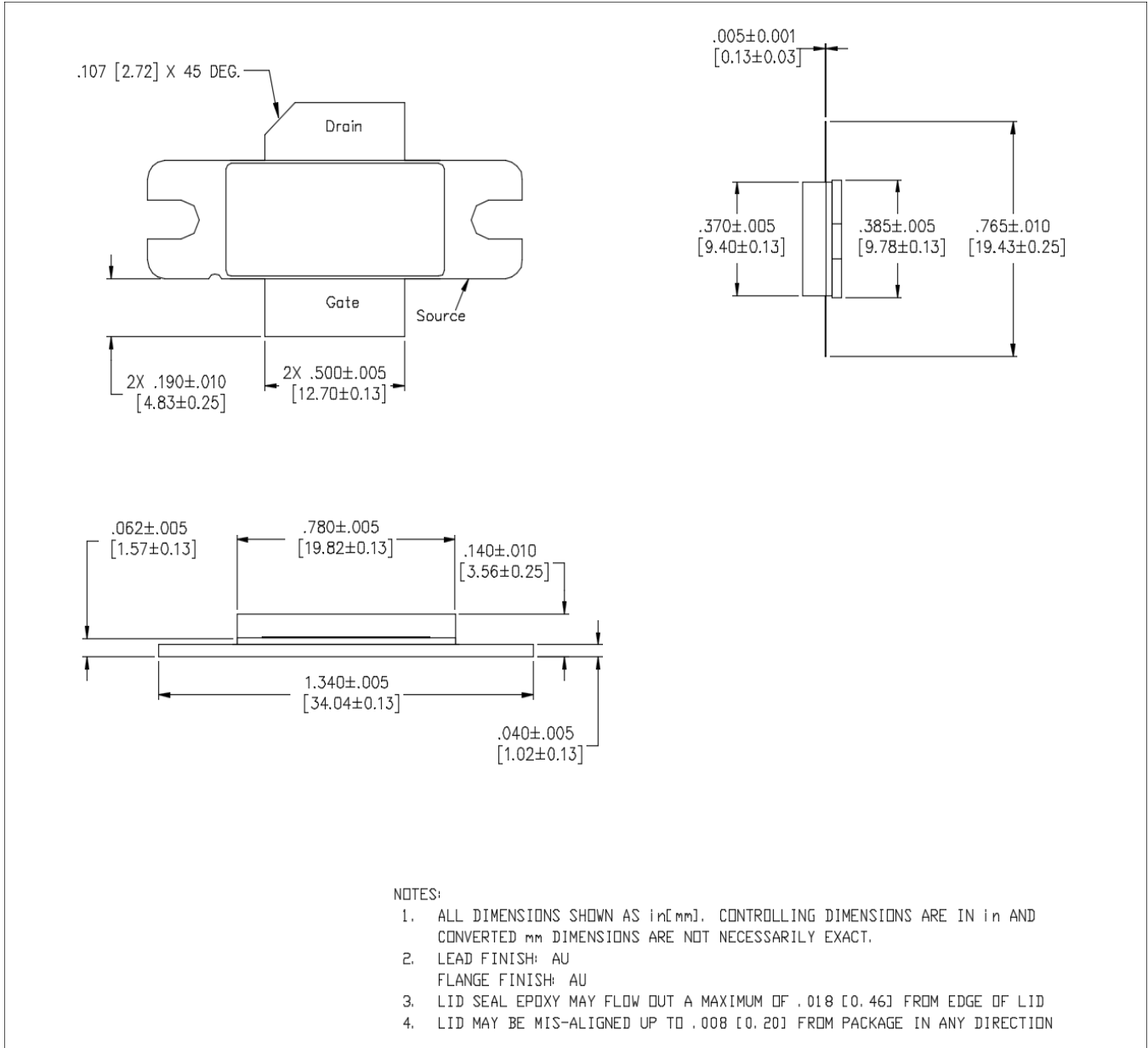

<sup>†</sup> Reference Application Note AN0004363 for mounting recommendations.  
Meets JEDEC moisture sensitivity level 3 requirements.  
Au plating on flange and leads.



**Lead-Free AC-780S-2 Ceramic Package Dimensions<sup>†</sup>**

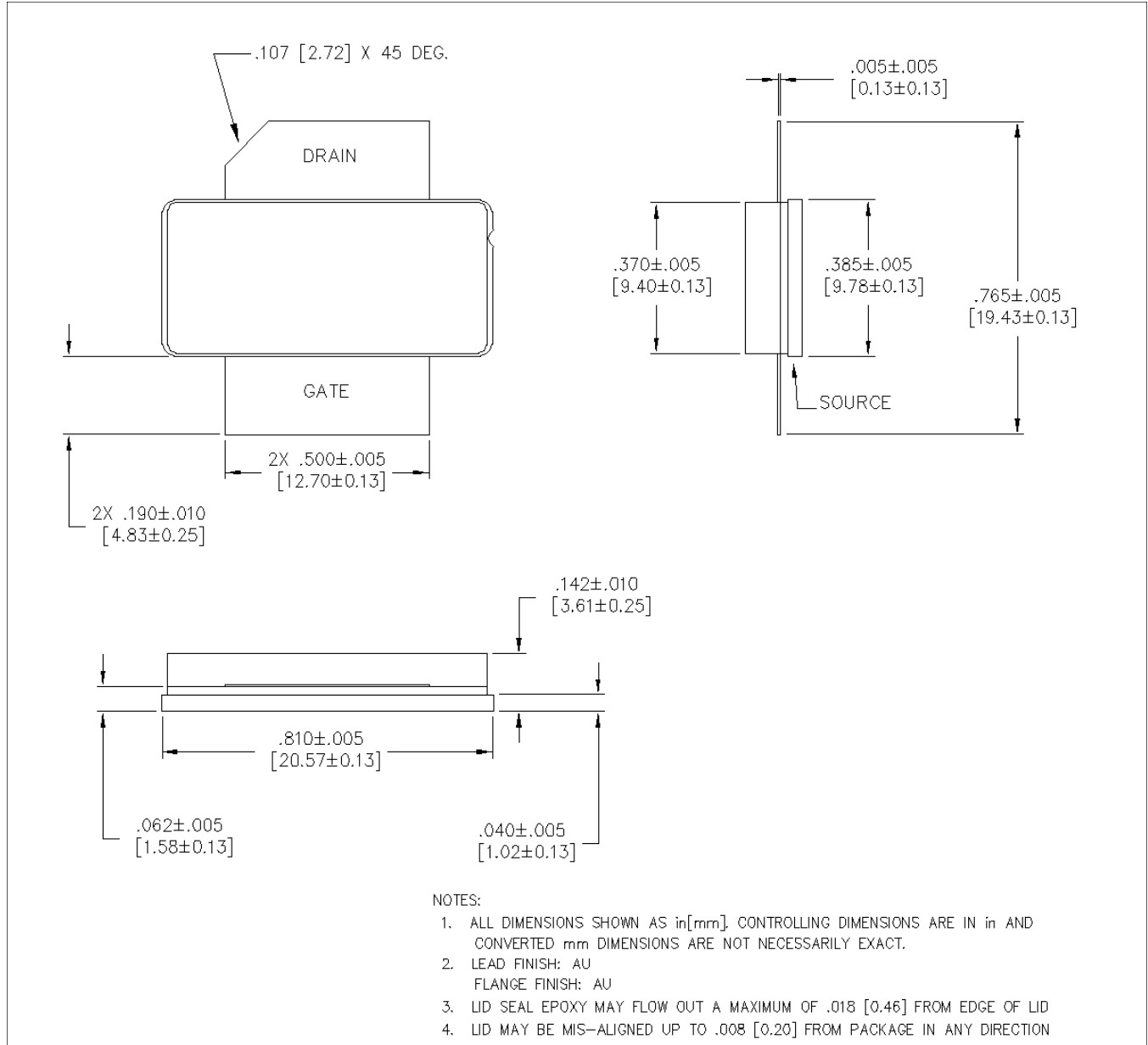

<sup>†</sup> Reference Application Note AN0004363 for mounting recommendations.  
Meets JEDEC moisture sensitivity level 3 requirements.  
Au plating on flange and leads.