

Features

- Broad Bandwidth Specified 50 MHz - 20 GHz
- Usable up to 26 GHz
- Low Insertion Loss
- High Isolation
- Low Parasitic Capacitance & Inductance
- Silicon Nitride Passivation
- Fully Monolithic, Glass Encapsulated Chip
- Up to 38 dBm CW Power Handling @ +25°C
- RoHS* Compliant

Applications

- Aerospace & Defense
- ISM

Description

The MASW-002103-1363 is a SPDT, surmount, broadband, monolithic switch using two sets of series and shunt connected PIN diodes. This device is designed for use in broadband, low to moderate signal, high performance, switch applications up to 20 GHz. It is a surface mountable switch configured for optimized performance and offers a distinct advantage over MMIC, beamlead and chip and wire hybrid designs. Because the PIN diodes of the MASW-002103-1363 are integrated into the chip and kept within close proximity, the parasitics typically associated with other designs that use individual components are kept to a minimum.

To minimize the parasitics and achieve high performance the MASW-002103-1363 is fabricated using MACOM's HMIC™ (Heterolithic Microwave Integrated Circuit) process. This process allows the silicon pedestals, which form the series and shunt diodes or vias, to be imbedded in low loss, low dispersion glass. The combination of low loss glass and using tight spacing between elements results in an HMIC device with low loss and high isolation through low millimeter wave frequencies.

The topside is fully encapsulated with silicon nitride and also has an additional layer of polymer for scratch and impact protection. The protective coating guards against damage to the junction and the anode airbridges during handling and assembly.

On the backside of the chip gold metalized pads have been added to produce a solderable surmount device.

Functional Schematic

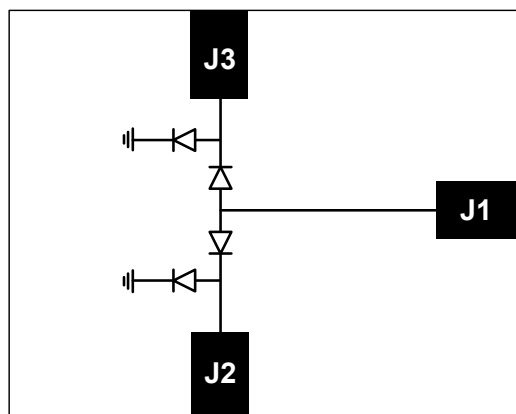

Pin Configuration

Pin	Function
J1	RFC
J2	RF1
J3	RF2

Ordering Information

Part Number	Package
MASW-002103-13630G	50 piece gel pack
MASW-002103-13635P	500 piece reel
MASW-002103-13630P	3000 piece reel
MASW-002103-001SMB	Sample Test Board
MASW-002103-002SMB	Demo Board with MABT-011000 Bias Network

* Restrictions on Hazardous Substances, compliant to current RoHS EU directive.

Electrical Specifications: $T_A = 25^\circ\text{C}$, $P_{IN} = 0 \text{ dBm}$, $Z_0 = 50 \Omega$, 20 mA/-10 V

Parameter	Frequency	Units	Min.	Typ.	Max.
Insertion Loss	6 GHz 13 GHz 20 GHz	dB	—	0.55 0.80 1.05	0.65 0.95 1.25
Input to Output Isolation	6 GHz 13 GHz 20 GHz	dB	38 28 23	52 38 27	—
Return Loss	6 GHz 13 GHz 20 GHz	dB	20 17.3 16.5	25 23 23	—
Input 0.1dB Compression Point	2 GHz	dBm	—	36	—
IIP3	0.05 GHz, 5 MHz Spacing, 10 dBm 0.5 GHz, 5 MHz Spacing, 20 dBm 1 GHz, 10 MHz Spacing, 20 dBm 2 GHz, 10 MHz Spacing, 20 dBm	dBm	—	45 59 63 66	—
Switching Speed ¹	—	ns	—	75	—
Voltage Rating ²	—	V	—	—	80

1. Typical Switching speed measured from (50% Control - 90% RF Voltage), in commutating mode at 10 kHz repetition rate, using the MACOM MADR-011022 Driver at -10 V @ -20 mA and +5 V @ +20 mA.
2. Maximum reverse leakage current in either the shunt or series PIN diodes shall be 0.5 μA maximum @ -80 volts.

Absolute Maximum Ratings^{3,4,5}

Parameter	Absolute Maximum
RF CW Incident Power	38 dBm CW @ 2 GHz 33 dBm CW @ 20 GHz
DC Reverse Voltage	80 V
Bias Current @ +25°C @ +85°C	$\pm 50 \text{ mA}$ $\pm 20 \text{ mA}$
Junction Temperature	+175°C
Operating Temperature	-65°C to +125°C
Storage Temperature	-65°C to +150°C

3. Exceeding any one or combination of these limits may cause permanent damage to this device.
4. MACOM does not recommend sustained operation near these survivability limits.
5. Maximum operating conditions for a combination of RF power, DC bias and temperature: +33 dBm CW @ 20 mA (per diode) @ +85°C.

Handling Procedures

Please observe the following precautions to avoid damage:

Static Sensitivity

These electronic devices are sensitive to electrostatic discharge (ESD) and can be damaged by static electricity. Proper ESD control techniques should be used when handling these HBM class 1A devices.

Typical Small Signal Performance @ +25°C (Probed On-Wafer RF Test)

Insertion Loss (20 mA Bias)

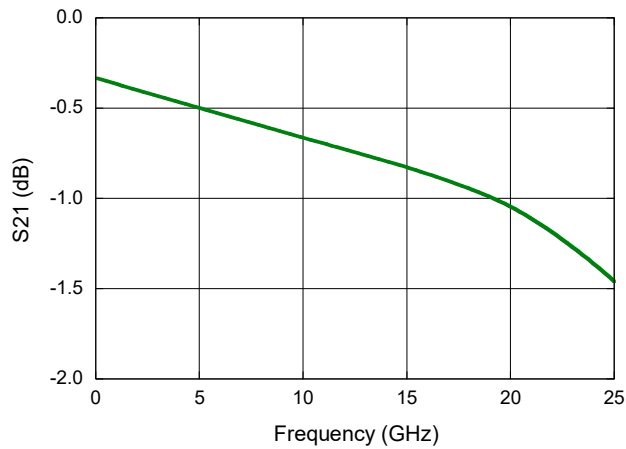

Isolation (20 mA Bias)

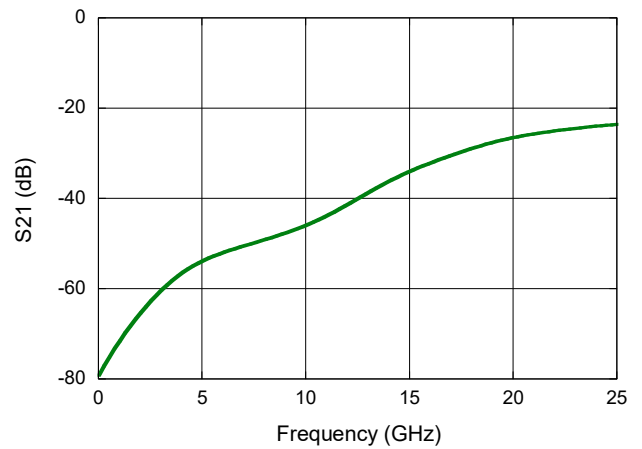

Input Return Loss (20 mA Bias)

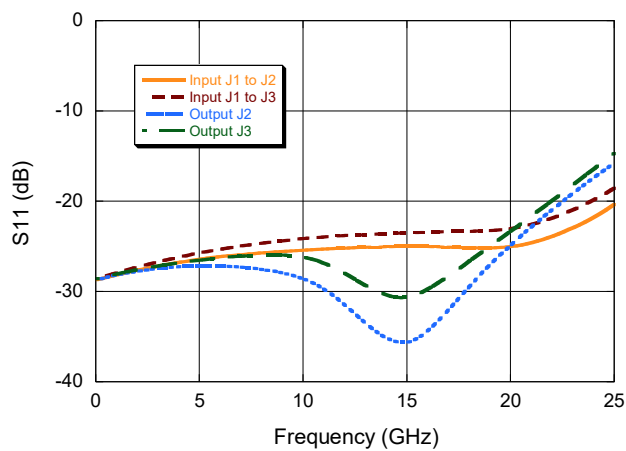

Maximum CW Input Power

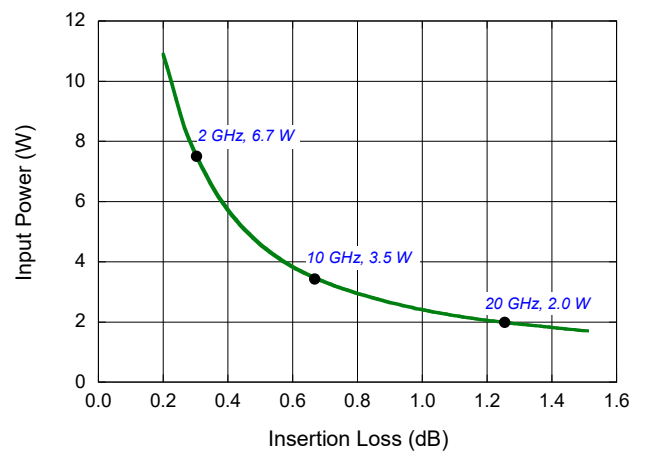

Operation of the MASW-002103-1363 PIN Switch

Optimal operation of the MASW-002103-1363 is achieved by simultaneous application of negative DC voltage and current to the low loss switching arm and positive DC voltage and current to the remaining switching arm as shown in the circuit diagram below. DC return is achieved via R2 on the RFC path. In the low loss state, the series diode must be forward biased with current and the shunt diode reverse biased with voltage. In the isolated arm, the shunt diode is forward biased with current and the series diode is reverse biased with voltage.

Typical Bias Network

Example:

- J1 to J2 → Low Loss
- R1 = 250 Ω
- R2 = 450 Ω
- B2 = -15 V
- B3 = +6 V

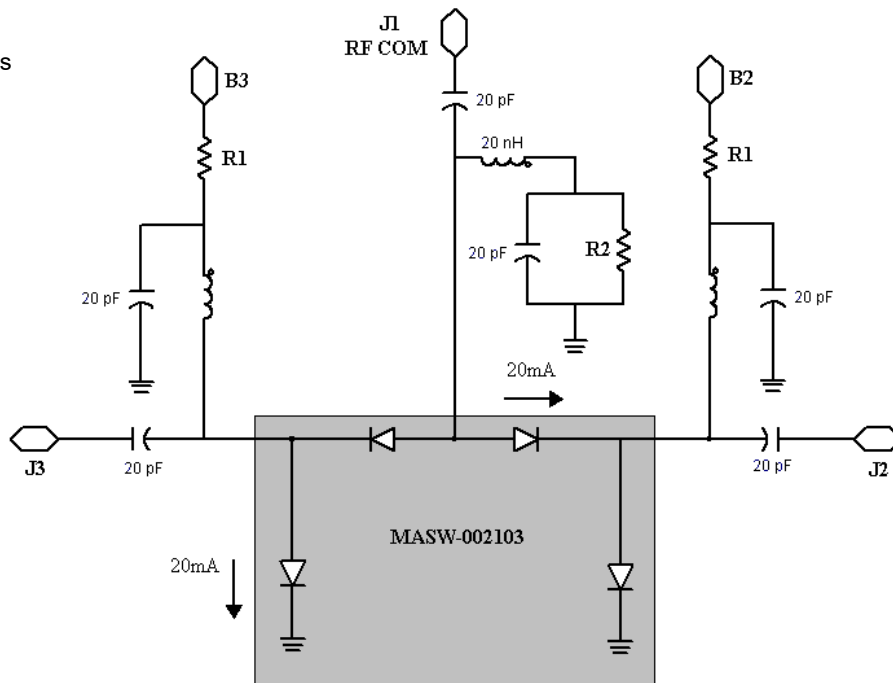

6. Assume $V_f \sim 1\text{ V @ } 20\text{ mA}$.
7. $R1 = 5\text{ V} / 0.02\text{ A} = 250\ \Omega$; $R2 = 9\text{ V} / 0.02\text{ A} = 450\ \Omega$.
8. $PR1 = 0.02\text{ A} \times 0.02\text{ A} \times 250\ \Omega = 0.1\text{ W}$.
9. $PR2 = 0.02\text{ A} \times 0.02\text{ A} \times 450 = 0.18\text{ W}$.
10. Inductors shown in the above schematic are RF bias chokes. The operating bandwidth of a broad-band PIN diode switch is often dependent on the bias components, particularly the RF bias chokes. It is suggested that the response at the frequencies of interest be measured with all the bias components in place prior to installing of MASW-002103-1363.

Typical Driver Connections

Suggest to use the MADR-011022 driver. See driver datasheet for detailed schematic.

DC Control Current (mA)		RF Output States	
B2	B3	J1-J2	J1-J3
-15 V @ -20 mA ¹¹	+6 V @ +20 mA	low loss	Isolation
+6 V @ +20 mA	-15 V @ 20 mA ¹¹	Isolation	low loss

11. The voltage applied to the off arm is allowed to vary provided a constant current is applied through the shunt diode on the off arm.

Outline Drawing (all dimensions in μm)

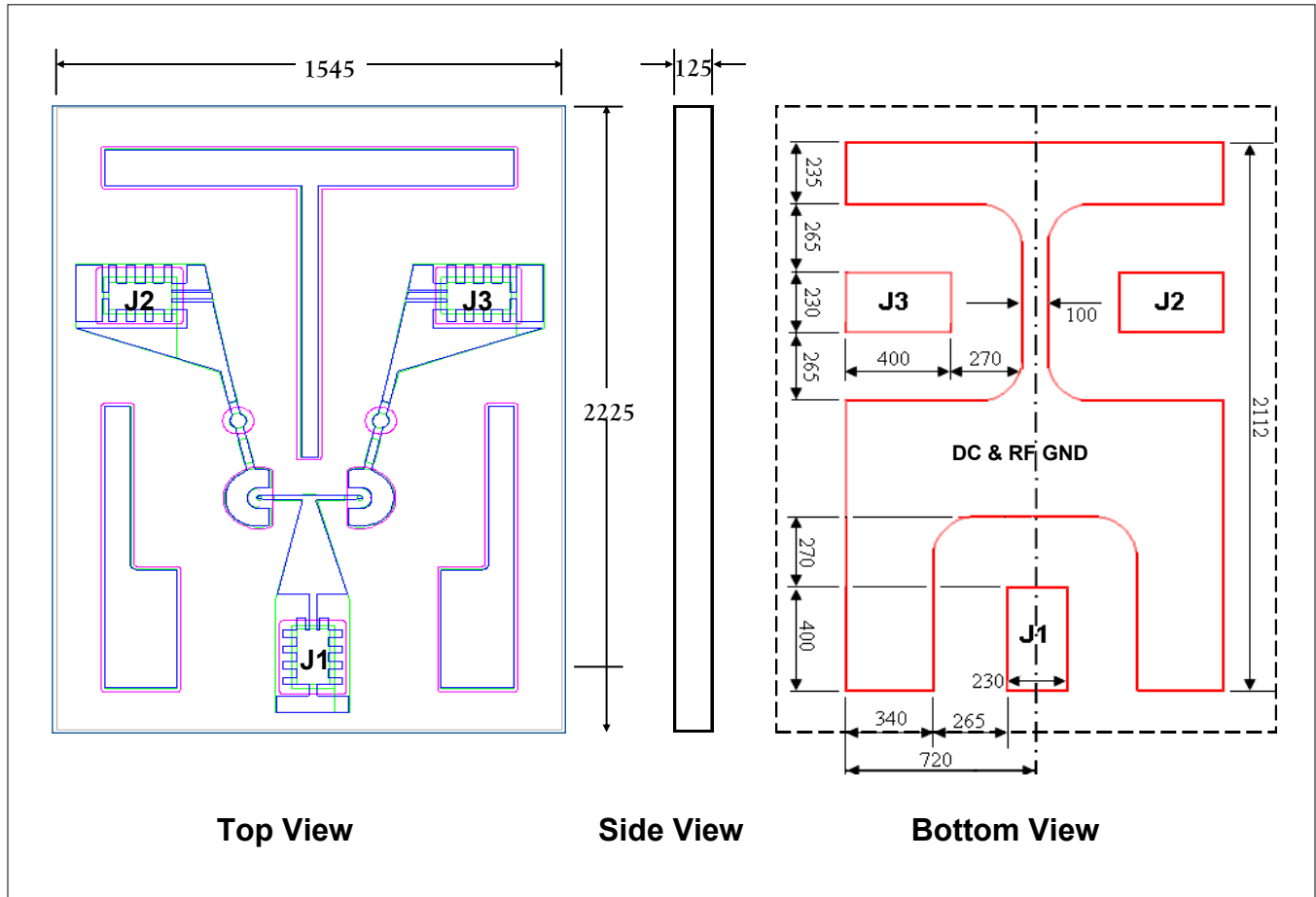

- 12. Bottom view shows the back metal foot print and mounting pads.
- 13. All dimension are +/-0.5 μm .
- 14. The center pad shown on the chip bottom view must be connected to RF and DC ground.

Dim.	Inches		mm	
	Min.	Max.	Min.	Max.
Width	0.060	0.062	1.52	1.57
Length	0.087	0.089	2.20	2.25
Thickness	0.004	0.006	0.10	0.15

Sample Board

Samples test boards are available upon request

Handling Procedures

Attachment to a circuit board is made simple through the use of standard surface mount technology. Mounting pads are conveniently located on the bottom of the chip and are removed from the active junction locations making it well suited for solder attachment. Connections may be made onto hard or soft substrates via the use of 80Au/20Sn, or RoHS compliant solders. Typical re-flow profiles for provided in [Application Note M538](#), "Surface Mounting Instructions" and can viewed in the Customer Support, Technical Resources section of the MACOM website at www.macom.com.

For applications where the average power is ≤ 1 W, a thermally conductive silver epoxy may also be used. Cure per manufacturers recommended time and temperature. Typically 1 hour at 150°C.

When soldering these devices to a hard substrate, a solder re-flow method is preferred. A vacuum pick up tool with a soft tip is recommended while placing the chip . When soldering to soft substrates, such as Duroid, a soft solder is recommended at the circuit board to chip mounting pad interface to minimize stress due to any TCE mismatches that may exist. Position the die so that its mounting pads are aligned with the circuit board land pads. Solder reflow should not be performed by causing heat to flow through the top surface of the die to the back. Since the HMIC glass is transparent, the edges of the mounting pads can be visually inspected through the die after attachment is completed.

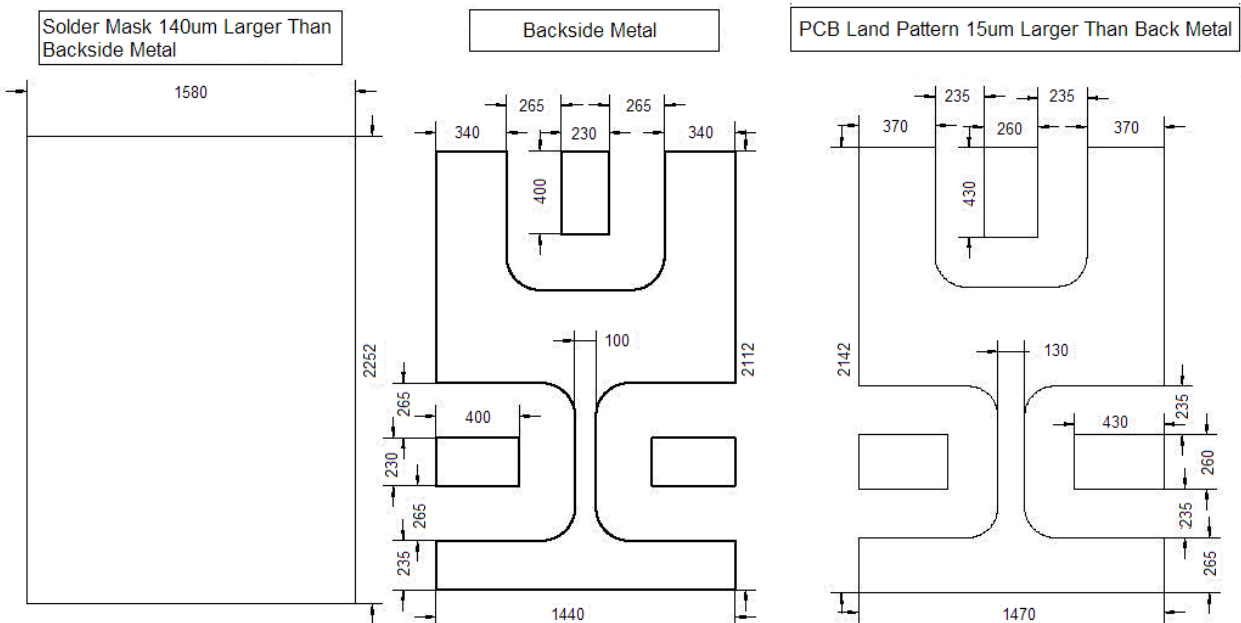

Pocket Tape Dimensions

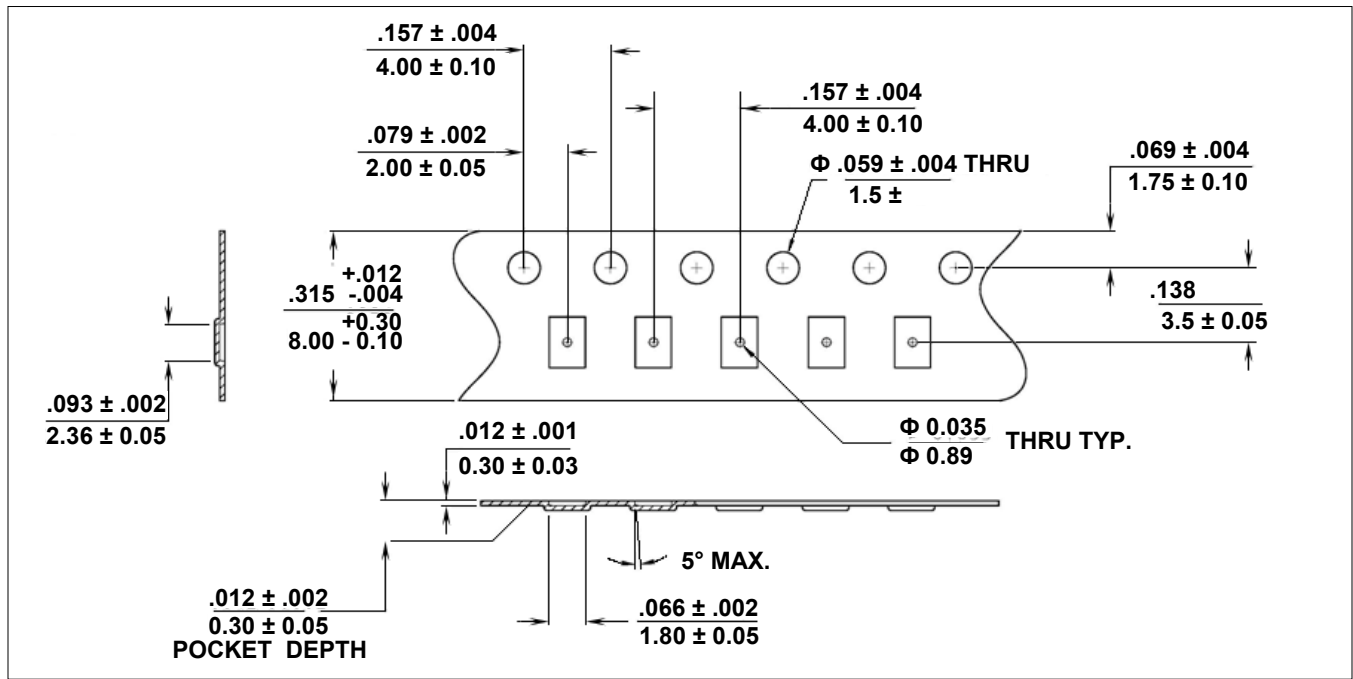

Chip Orientation in Pocket

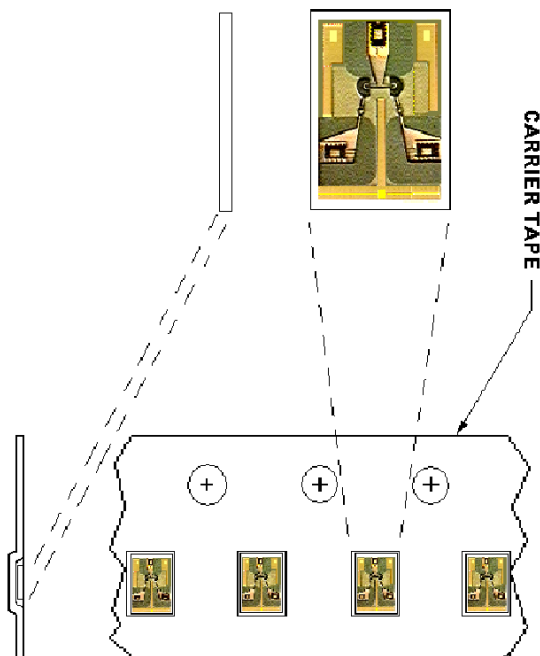

Reel Information

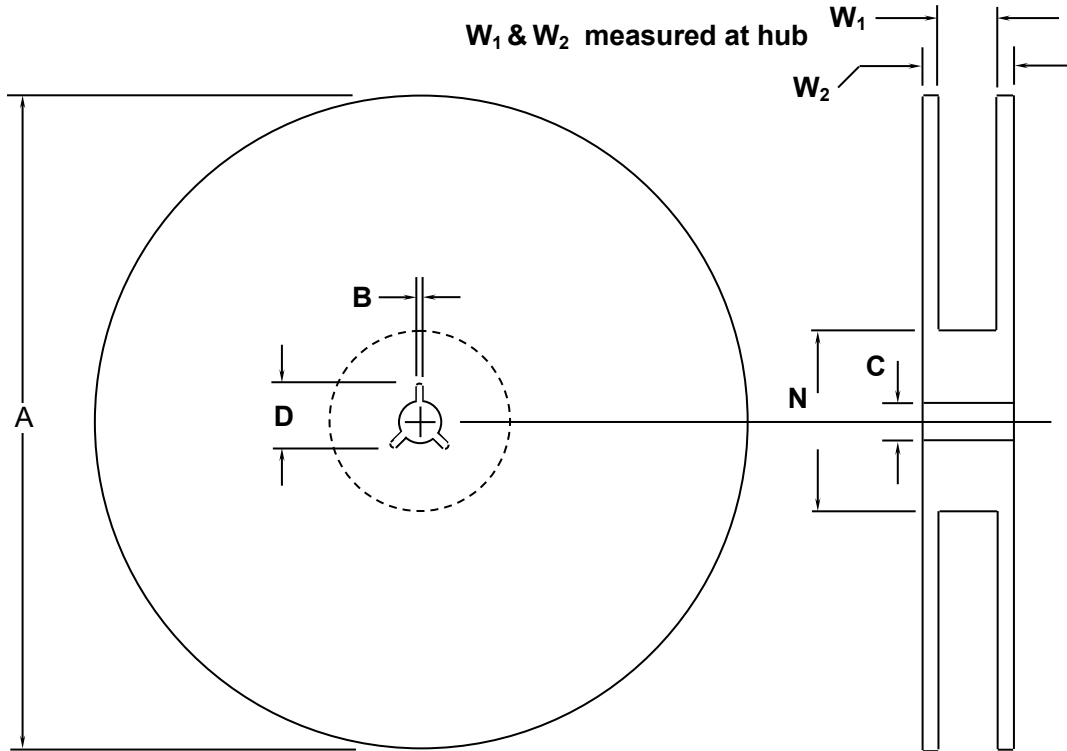

Dim.	Inches		mm	
	Min.	Max.	Min.	Max.
A	6.98	7.02	177.3	178.3
B	.059	.098	1.5	2.5
C	.504	.520	12.8	13.2
D	.795	.815	20.2	20.7
N	2.14	2.19	54.5	55.5
W ₁	.331	.337	8.4	8.55
W ₂	—	.567	—	14.4

Demonstration Board Switch with Bias Networks (MASW-002103-002SMB)

This board demonstrates the use and performance of the MASW-002103 surface mount switch with a MABT-011000 surface mount bias network on each RF line. It is set up with the option to measure the devices with SMA connectors¹⁵ or to probe the devices directly at the RF ports (Indicates Actual Performance).¹⁶ The MABT-011000 alone can be probed directly as well. There are calibration THRU lines included for each measurement.

- 15. The microstrip RF lines used to measure the devices with SMA connectors are only good up to 15 GHz. Actual performance is indicated by "Probed" data shown.
- 16. 450 μm pitch GSG RF Probes.

Recommended Bias Set-Up^{17,18}

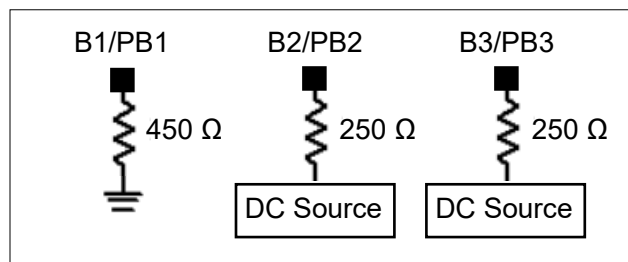

- 17. B1, B2, and B3 refer to SMA connectorized section bias pins while PB1, PB2, and PB3 refer to probed section bias pins.
- 18. Resistors not included on demonstration board.

Typical Driver Connections

DC Control Current (mA)		RF Output States	
B2	B3	J1-J2	J1-J3
-15 V @ -20 mA ¹⁹	+6 V @ +20 mA	low loss	Isolation
+6 V @ +20 mA	-15 V @ -20 mA ¹⁹	Isolation	low loss

- 19. The voltage applied to the off arm is allowed to vary provided a constant current is applied through the shunt diode on the off arm.

Demonstration Board

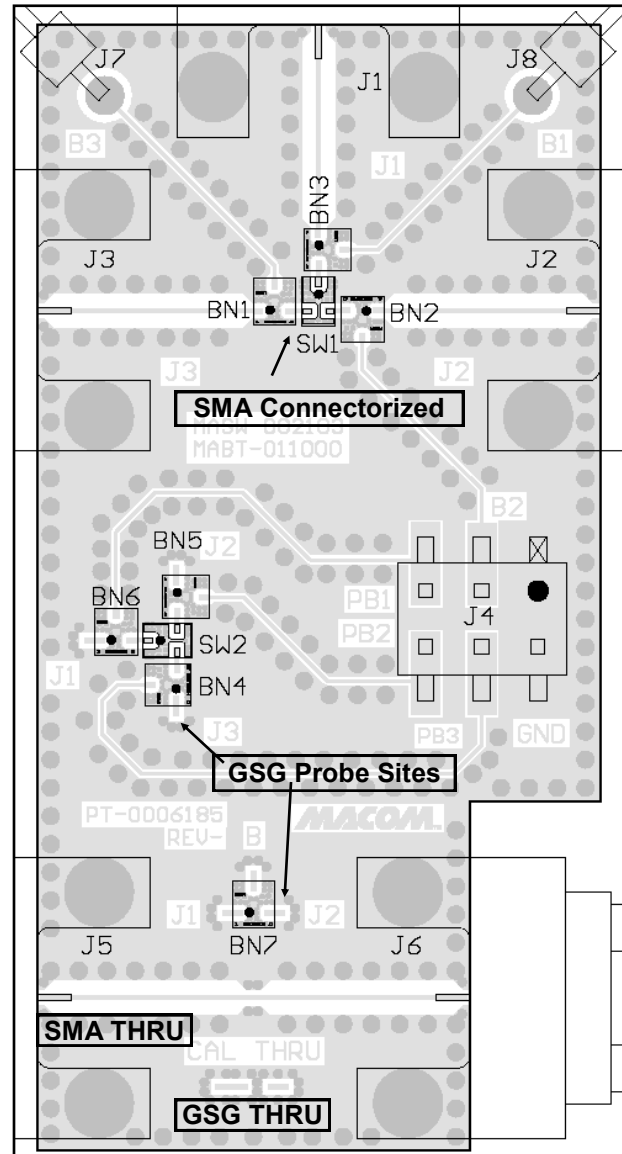

Included parts

- 1 LCP printed circuit board (4 mil thick RO3850)
- 1 support plate
- 5 Southwest 292-07A-5 SMA end launch connectors
- 2 MASW-002103 switches
- 7 MABT-011000 bias networks
- 1 Molex 6-Pin header
- 2 Molex single pin right angle headers

Performance Curves

Demonstration Board Switch with Bias Networks (MASW-002103-002SMB)

Insertion Loss (20 mA Bias)

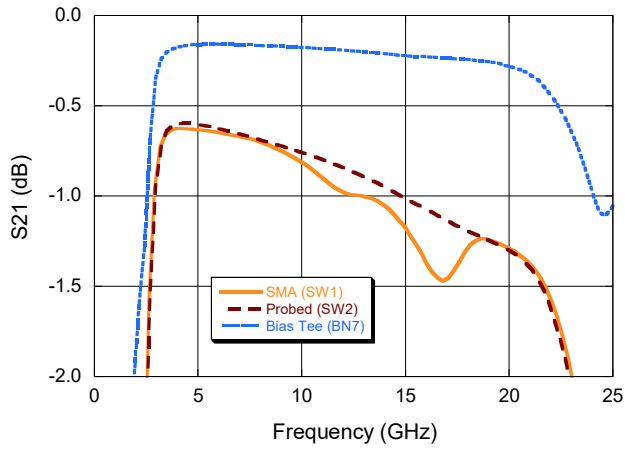

Isolation (20 mA Bias)

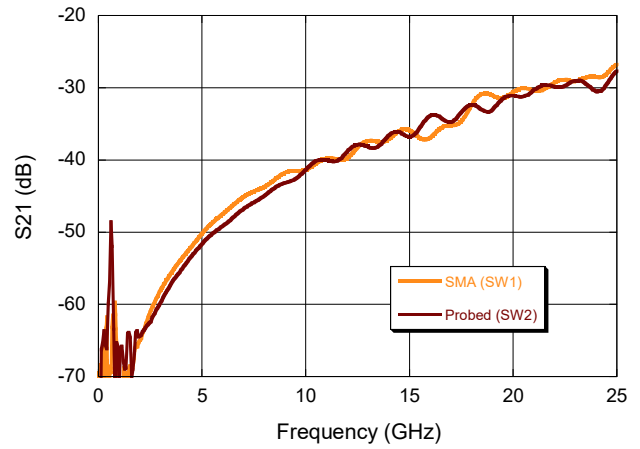

Input Return Loss (20 mA Bias)

