

GaAs SPDT Non-Reflective Switch DC - 30 GHz



MASW-011102

Rev. V2

Features

- Broadband Performance
- Low Insertion Loss: 1.8 dB @ 30 GHz
- High Isolation: 40 dB @ 30 GHz
- Fast Switching Speed
- Non-Reflective Configuration
- Ultra Low DC Power Consumption
- Lead-Free 3 mm 14-Lead PQFN Package
- RoHS* Compliant

Applications

- Test & Measurement

Description

The MASW-011102 is a versatile, broadband, non-reflective, high isolation SPDT switch offered in a lead-free 3 mm 14-lead PQFN surface mount plastic package. The switch operates from DC to 30 GHz and provides <1.8 dB insertion loss and >40 dB isolation. The combination of broadband performance along with fast switching and excellent settling time make this device ideal for many applications, including test & measurement, EW and broadband communication systems.

The MASW-011102 uses MACOM's robust process with full surface passivation for high performance and high reliability.

Ordering Information^{1,2}

Part Number	Package
MASW-011102-TR0500	500 piece reel
MASW-011102-TR1000	1000 piece reel
MASW-011102-SMB	Sample Board

1. Reference Application Note M513 for reel size information.
2. All sample boards include 2 loose parts.

Functional Schematic

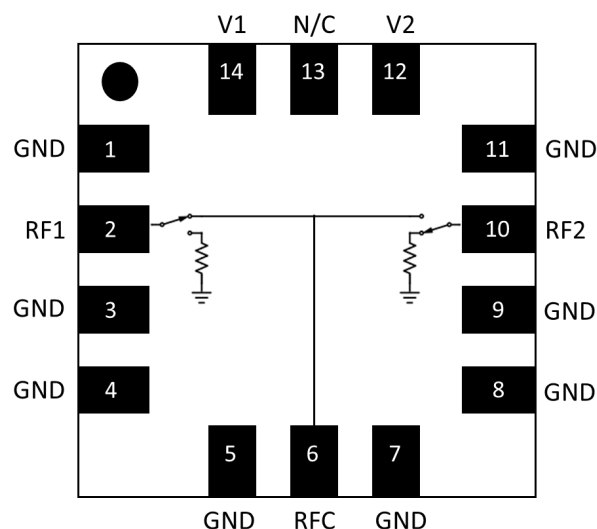

Pin Configuration³

Pin #	Pin Name	Function
1,3,4,5,7,8,9,11	GND	Ground
2	RF1	RF Port1
6	RFC	RF Common
10	RF2	RF Port2
12	V2	Control Voltage
13	N/C	No Connection
14	V1	Control Voltage
15	Paddle ⁴	Ground

3. MACOM recommends connecting all ground and N/C pins to ground.
4. The exposed pad centered on the package bottom must be connected to RF, DC and thermal ground.

* Restrictions on Hazardous Substances, compliant to current RoHS EU directive.

GaAs SPDT Non-Reflective Switch

DC - 30 GHz



MASW-011102

Rev. V2

Electrical Specifications: $V_{1,2} = 0/-5\text{ V}$, $Z_0 = 50\ \Omega$, $T_A = +25^\circ\text{C}$

Parameter	Test Conditions	Units	Min.	Typ.	Max.
Insertion Loss	0.5 GHz	dB	—	0.7	—
	10 GHz			1.1	—
	20 GHz			1.4	—
	30 GHz			1.8	2.5
Isolation	0.5 GHz	dB	—	64	—
	10 GHz		—	44	
	20 GHz		—	44	
	30 GHz		35	40	
Return Loss	DC - 30 GHz	dB	—	15	—
	RFC			15	
	RF1, RF2 "on state" RF1, RF2 "off state"			12	
Input P0.1dB	0.5 - 30 GHz	dBm	—	23	—
Input IP3	2 Tone, 5 dBm/Tone, 5MHz spacing, 0.5-30 GHz	dBm	—	45	—
$T_{\text{RISE}}, T_{\text{FALL}}$	10% to 90% RF and 90% to 10% RF	ns	—	40	—
$T_{\text{ON}}, T_{\text{OFF}}$	50% control to 90% RF and 50% control to 10% RF	ns	—	50	—
Control Current (Complementary Logic)	—	μA	—	1	5

Absolute Maximum Ratings^{5,6}

Parameter	Absolute Maximum
Control Voltage	$-8\text{ V} < V_x < 0.5\text{ V}$
Input Power	25 dBm
Operating Temperature	-40°C to $+85^\circ\text{C}$
Storage Temperature	-65°C to $+150^\circ\text{C}$

- Exceeding any one or combination of these limits may cause permanent damage to this device.
- MACOM does not recommend sustained operation near these survivability limits.

Truth Table⁷

Control Input		Condition of Switch	
V1	V2	RF1	RF2
0	1	On	Off
1	0	Off	On

7. Logic "0" = -0.2 to 0 V, Logic "1" = -5 to -5.2 V.

Handling Procedures

Please observe the following precautions to avoid damage:

Static Sensitivity

These electronic devices are sensitive to electrostatic discharge (ESD) and can be damaged by static electricity. Proper ESD control techniques should be used when handling these devices.

PCB Layout Recommendation

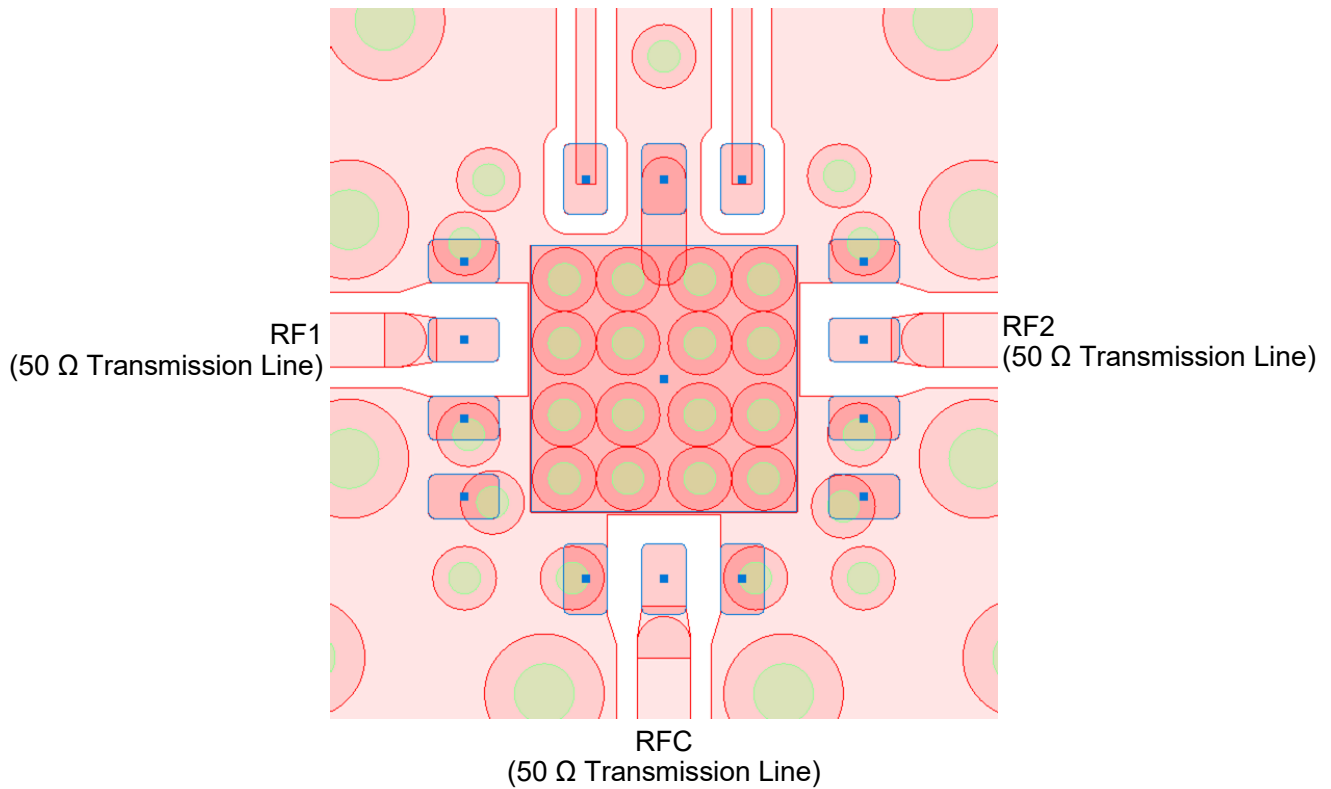

Ground via length and pattern under package paddle is critical to electrical performance.

Typical Performance Curves

Insertion Loss

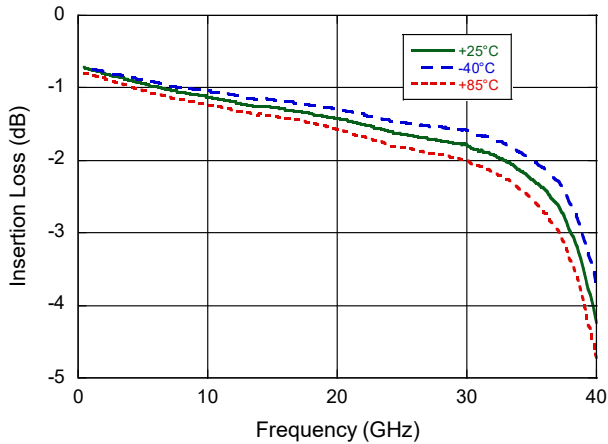

Isolation

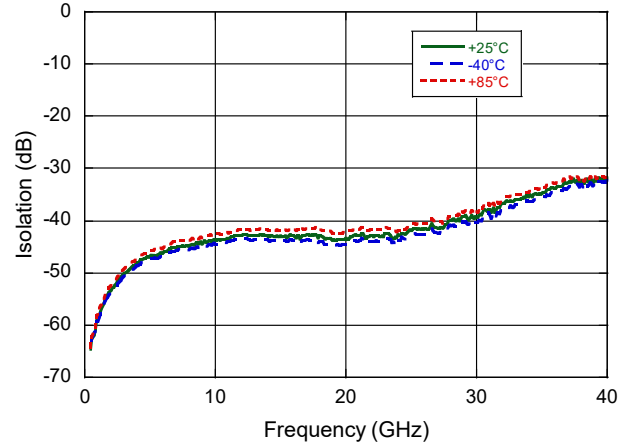

Return Loss, RF Common

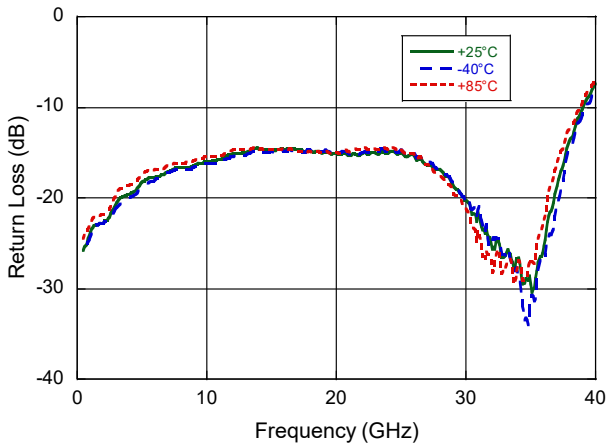

Return Loss, RFx On

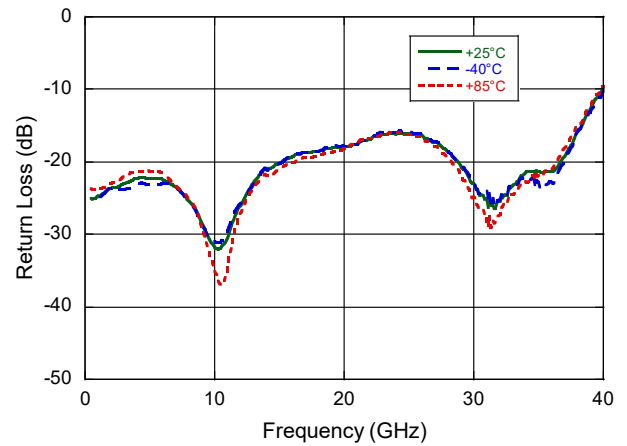

Return Loss, RFx Off

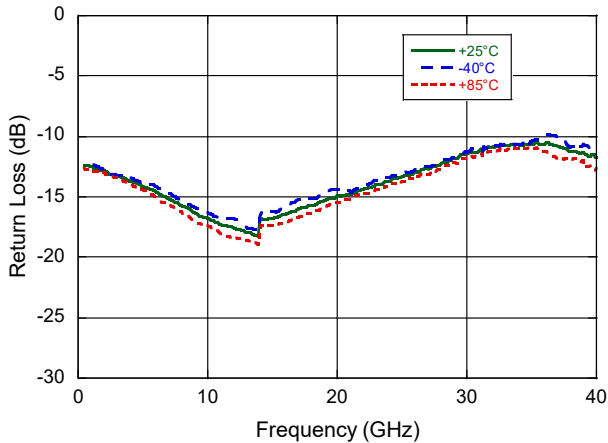

Gain Compression @ 15 GHz

