

SP4T Absorptive Switch

DC - 57 GHz



MASW-011154

Rev. V2

Features

- Ultra Wideband: 9 kHz to 57 GHz
- Insertion Loss:
 - 2.0 dB @ 18 GHz
 - 2.8 dB @ 40 GHz
 - 4.0 dB @ 57 GHz
- Isolation:
 - 46 dB @ 18 GHz
 - 41 dB @ 40 GHz
 - 39 dB @ 57 GHz
- Input P1dB: 28.5 dBm
- Input IP3: 51 dBm
- Return Loss at Each RF Port: 16 dB
- Power Handling including Hot Switching: 26 dBm
- No Low Frequency Spurious
- Compatible with 1.8, 2.5, and 3.3 V CMOS Logic
- 3 mm, 22 pin Laminate Package
- RoHS* Compliant

Applications

- Test & Measurement
- ISM, Multi Market

Description

The MASW-011154 is an absorptive, ultra wideband single pole four throw (SP4T) switch with 4.0 dB of insertion loss at 57 GHz. The RF output ports are terminated in 50 ohms in the isolated paths. The power handling capability is 26 dBm. The input and output return losses in the thru path are typically 16 dB. The logic levels are compatible with standard 1.8, 2.5, or 3.3 V CMOS. Required bias supplies are +3.3 V and -3.3 V.

The MASW-011154 is designed for wideband applications such as Test and Measurement, Aerospace and Defense, Cellular infrastructure (5G millimeter-wave), military radios, radars, microwave radios and very small aperture terminals (VSATs).

The MASW-011154 is manufactured on a Silicon-on-Insulator process. The 3 mm laminate package is lead free and RoHS compliant.

Functional Schematic

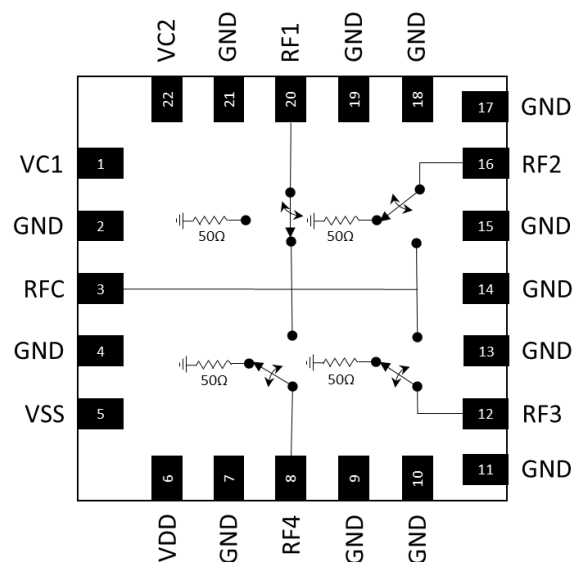

Pin Configuration¹

Pin #	Pin Name	Description
1	VC1	Control Voltage 1
2,4,7,9-11,13-15,17-19,21	GND	Ground
3	RFC ²	Common RF Input/Output
5	VSS	-3.3 V
6	VDD	+3.3 V
8	RF4 ²	RF Input/Output 4
12	RF3 ²	RF Input/Output 3
16	RF2 ²	RF Input/Output 2
20	RF1 ²	RF Input/Output 1
22	VC2	Control Voltage 2

1. The exposed pad centered on the package bottom must be connected to RF, dc, and thermal ground.
2. RF ports are dc-coupled to GND. There are no internal dc blocking capacitors.

Ordering Information^{3,4}

Part Number	Package
MASW-011154-TR0500	500 piece reel
MASW-011154-SB1	Sample Board

3. Reference Application Note M513 for reel size information.
4. All sample boards include 3 loose parts.

¹ * Restrictions on Hazardous Substances, compliant to current RoHS EU directive.

SP4T Absorptive Switch

DC - 57 GHz



MASW-011154

Rev. V2

Electrical Specifications⁵:

$V_{DD} = +3.3\text{ V}$, $V_{SS} = -3.3\text{ V}$, $V_{C1} / V_{C2} = 0\text{ V or } 1.8\text{ V}$, $T_{PADDLE} = 25^{\circ}\text{C}$, $Z_0 = 50\ \Omega$

Parameter	Test Conditions	Units	Min.	Typ.	Max.
Insertion Loss	DC to 18 GHz	dB	—	1.6	—
	18 GHz			2.0	2.6
	30 GHz			2.2	3.0
	44 GHz			2.8	4.4
	57 GHz			4.0	—
Isolation, Between RF1 / RF2 / RF3 / RF4 (Worst Path)	DC to 18 GHz	dB	—	49	—
	18 GHz			46	
	30 GHz			43	
	44 GHz			41	
	57 GHz			39	
Isolation, RFC to RF1 / RF2 / RF3 / RF4 (Worst Path)	DC to 18 GHz	dB	—	52	—
	18 GHz		42	47	
	30 GHz		38	47	
	44 GHz		—	41	
	57 GHz		—	39	
RFC Return Loss	DC - 57 GHz	dB	—	16	—
RF1/RF2/RF3/RF4 Return Loss, Thru Port	DC - 57 GHz	dB	—	16	—
RF1/RF2 Return Loss, Isolated Port	DC - 67 GHz	dB	—	16	—
Input P0.1dB	10 MHz - 57 GHz	dBm	—	27.5	—
Input P1dB	10 MHz - 57 GHz	dBm	—	28.5	—
Input IP3	Two tone, $P_{IN}/\text{tone} = +14\text{ dBm}$ 10 MHz - 57 GHz	dBm	—	51	—
T_{ON}	50% control to 90% RF	μs	—	1.1	—
T_{RISE}	10% to 90% RF	μs	—	0.5	—
T_{OFF}	50% control to 10% RF	μs	—	0.16	—
T_{FALL}	90% to 10% RF	μs	—	0.04	—
Voltage Supply, VDD	—	V	+3.15	+3.3	+3.45
Voltage Supply, VSS	—	V	-3.45	-3.3	-3.15
Logic Voltage, Input Low (V_{IL})	—	V	0.0	—	+0.8
Logic Voltage, Input High (V_{IH})	—	V	+1.2	—	VDD
Supply Current, VDD	—	mA	—	0.3	0.5
Supply Current, VSS	—	mA	—	0.66	1.0
Logic Pin Current (V_{C1} / V_{C2})	Pulled down to GND with 100 k Ω resistor	μA	—	VC*10	—

5. Parameters are measured on a test board that includes impedance matching. Device shall be aligned to recommended PCB footprint +/- 1 mil for optimum performance

Maximum Operating Conditions

Parameter	Maximum
Input Power, 300 MHz to 40 GHz, RFC Port ⁶ RF1 / RF2 / RF3 / RF4 Port ⁶	26 dBm 26 dBm
VDD	-0.3 to +3.45 V
VSS	-3.45 to +0.3 V
VC1 / VC2	-0.3 to 3.45 V
Operating Temperature ⁷	-40 to +105°C

6. T_{PADDLE} = 105 °C. See power derating curves for details.

7. Guarantees 10 years lifetime.

Power Derating Curve⁶

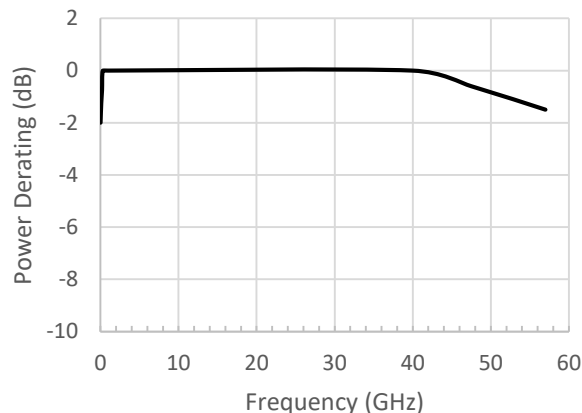

Absolute Maximum Ratings^{8,9,10}

Parameter	Absolute Maximum
Input Power, 300 MHz to 40 GHz, RFC Port ⁶ RF1 / RF2 / RF3 / RF4 Port ⁶	27 dBm 27 dBm
VDD	-0.3 to +3.6 V
VSS	-3.6 to +0.3 V
VC1 / VC2	-0.3 to 3.6 V
Junction Temperature	+135°C

8. Exceeding any one or combination of these limits may cause permanent damage to this device.

9. MACOM does not recommend sustained operation near these survivability limits.

10. Based on testing with input power applied for 30 seconds.

Low Frequency Power Derating Detail⁶

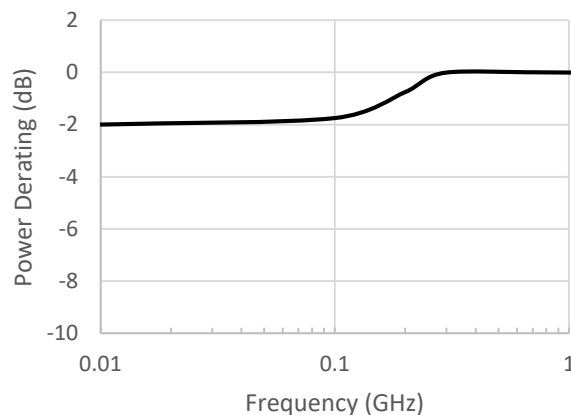

Truth Table

Control 1	Control 2	Condition of Switch			
		RF1	RF2	RF3	RF4
V _{IL}	V _{IL}	On	Off	Off	Off
V _{IH}	V _{IL}	Off	On	Off	Off
V _{IL}	V _{IH}	Off	Off	On	Off
V _{IH}	V _{IH}	Off	Off	Off	On

Handling Procedures

Please observe the following precautions to avoid damage:

Static Sensitivity

These electronic devices are sensitive to electrostatic discharge (ESD) and can be damaged by static electricity. Proper ESD control techniques should be used when handling these devices.

Parameter	Rating	Standard
Human Body Model (HBM)	Class 1C	ESDA/JEDEC JS-001
Charged Device Model (CDM)	Class C3	ESDA/JEDEC JS-002

Application Schematic

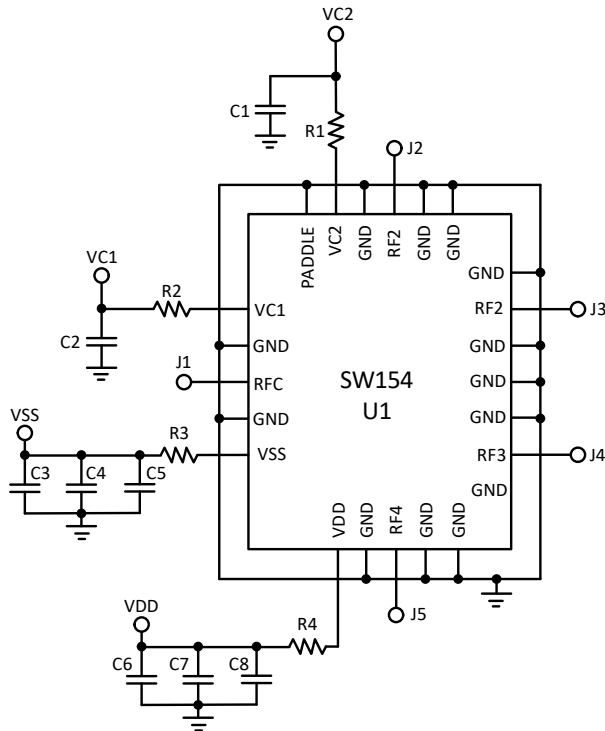

Impedance Match

MASW-011154-SB1 is a 2-layer board with 8 mil Rogers RO4003 dielectric material and 1 oz. copper on top and bottom layers. For this stack-up, 5 mil traces with 7 mil width are used for all RF port matching, as shown below.

The 50Ω RF transmission lines are CPWG of 14 mil width with 6.5 mil gap.

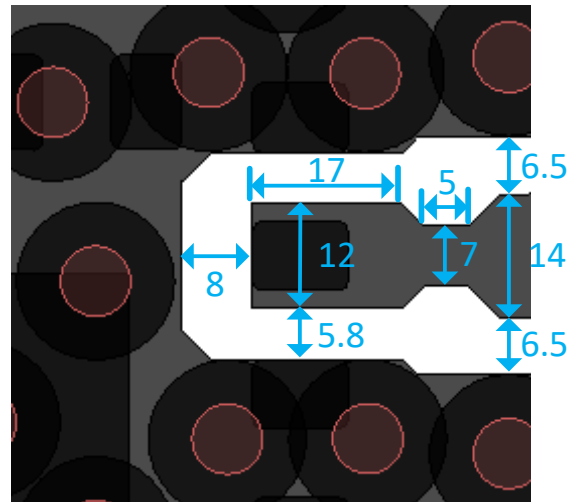

Parts List

Part	Value	Case Style
U1	MASW-011154	3 mm, 22 Lead
C1, C2	Capacitor, 5 pF, 16 V	0402
C3, C6	Capacitor, 10 pF, 50 V	0402
C4, C7	Capacitor, 1000 pF, 25 V	0402
C5, C8	Capacitor, 1 μF, 10 V	0402
R1 - R4	Resistor, 0 Ω	0402
J1 - J5	Southwest 1892-04A-6	End Launch

Evaluation Board Layout

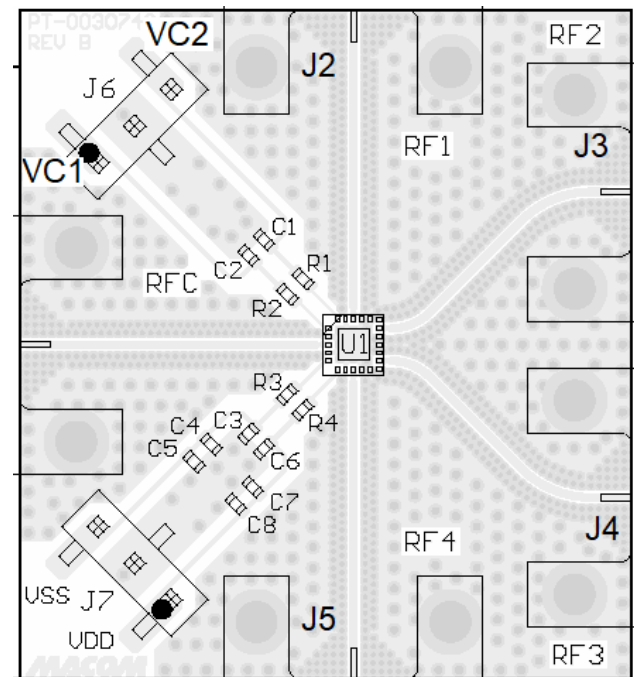

Typical Performance Curves

Insertion Loss¹¹

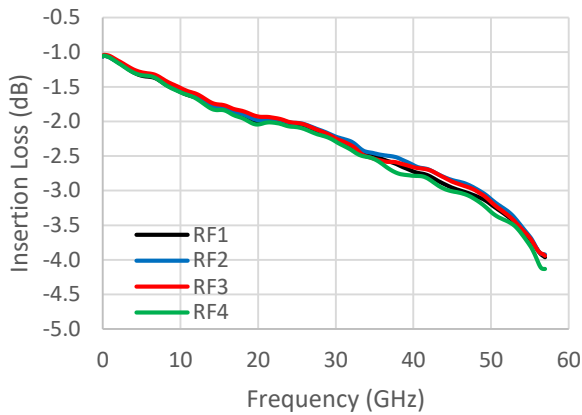

RFC to RF1 Insertion Loss over Temperature¹¹

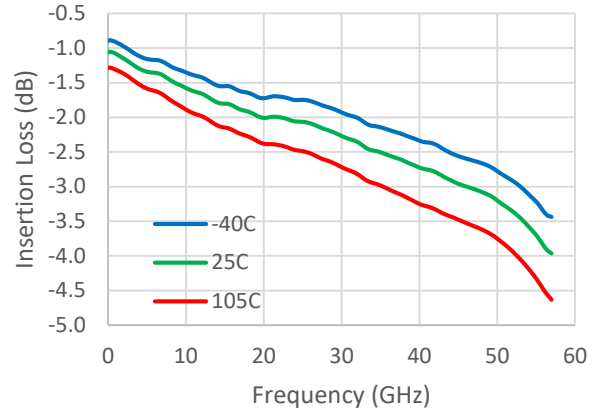

RFC Return Loss¹²

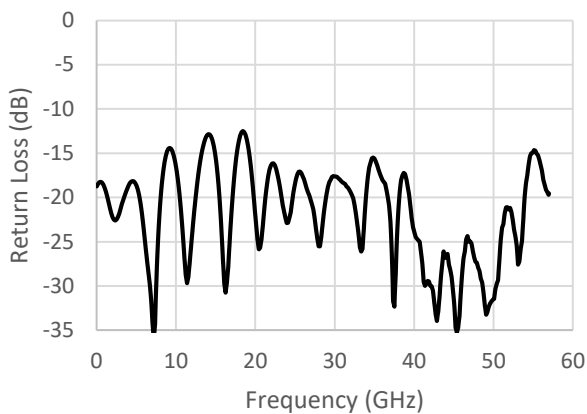

RF1/RF2/RF3/RF4 Return Loss¹²

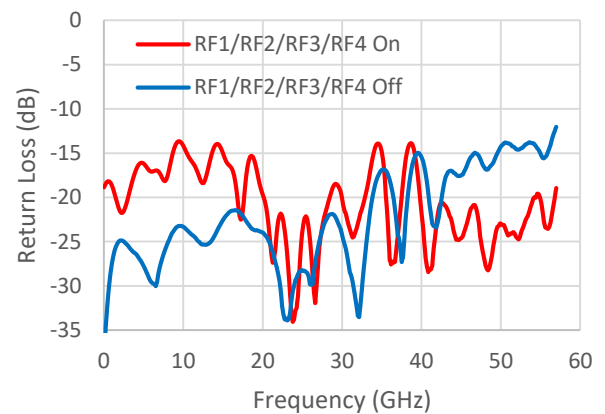

Evaluation Board Thru Line Insertion Loss

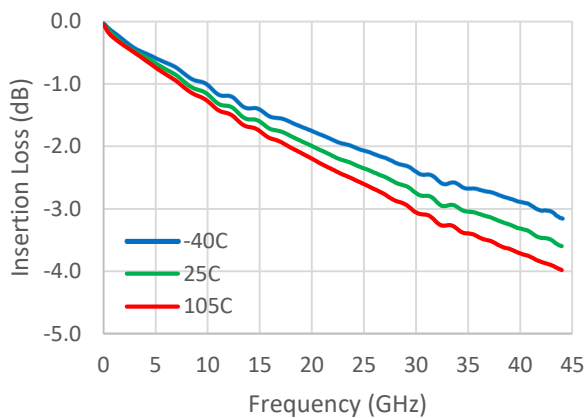

Evaluation Board Thru Line Return Loss

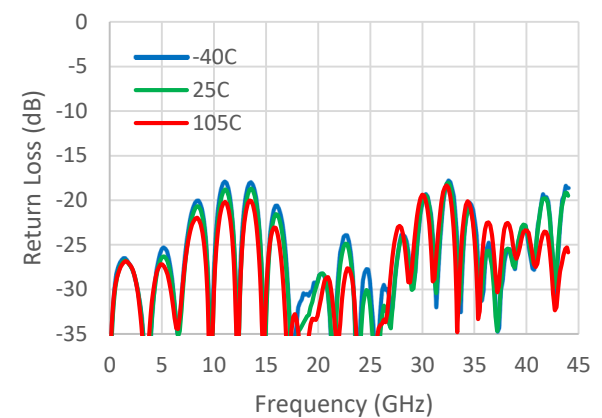

11. Insertion Loss and Isolation were measured using connectorized evaluation board with impedance match on RF transmission lines, and normalized using the insertion loss of the 50Ω thru line.

5 12. Return Loss with impedance match were measured using connectorized evaluation board with impedance match on RF transmission lines.

MACOM Technology Solutions Inc. (MACOM) and its affiliates reserve the right to make changes to the product(s) or information contained herein without notice. Visit www.macom.com for additional data sheets and product information.

Typical Performance Curves

RFC to RF2 / RF3 / RF4 Isolation, RFC to RF1 On¹¹

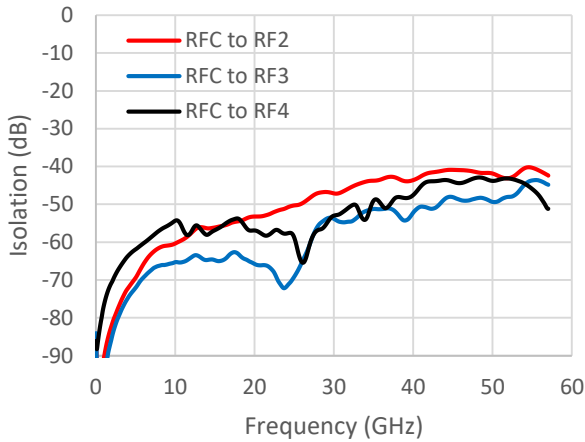

RFC to RF1 / RF2 / RF3 Isolation, RFC to RF4 On¹¹

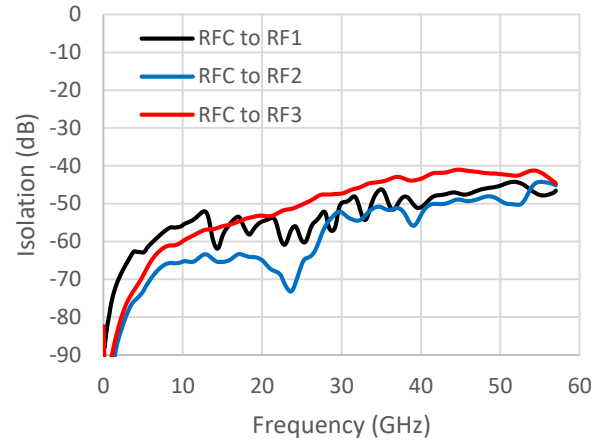

RFC to RF1 / RF3 / RF4 Isolation, RFC to RF2 On¹¹

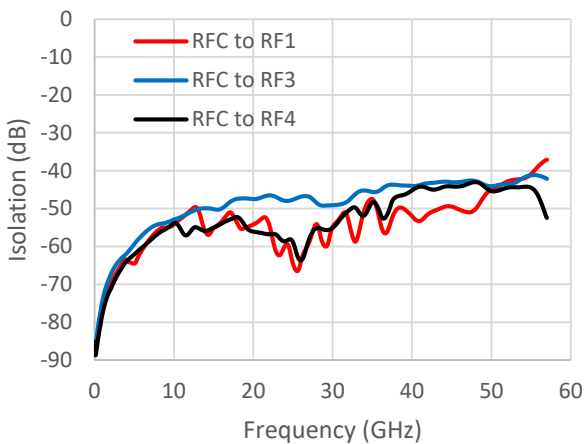

RFC to RF1 / RF2 / RF4 Isolation, RFC to RF3 On¹¹

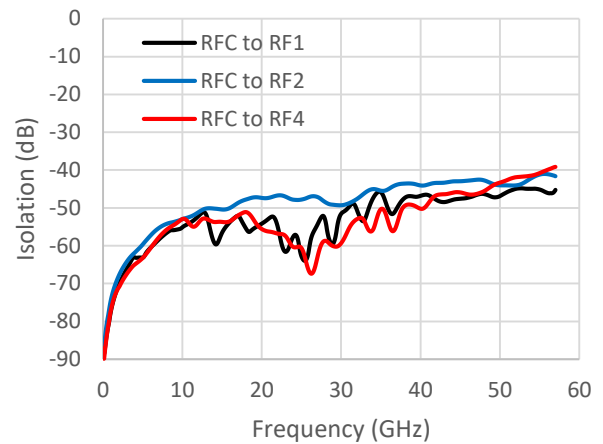

Isolation between RF1 to RF4, RFC to RF1 On¹¹

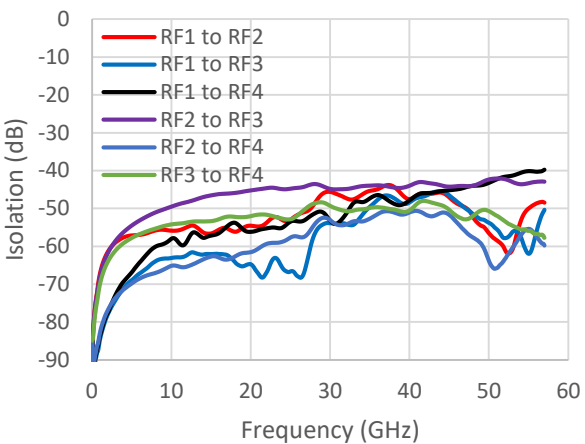

Isolation between RF1 to RF4, RFC to RF4 On¹¹

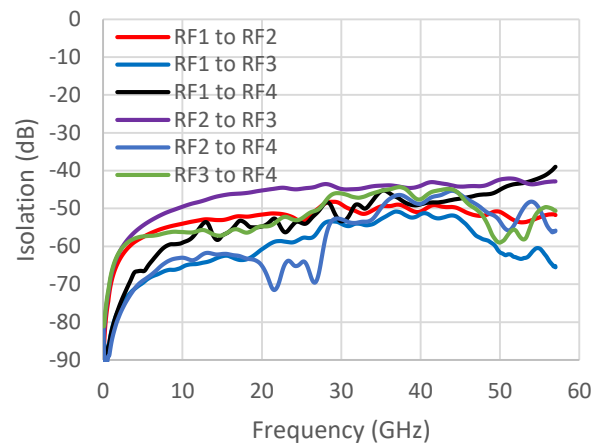

Typical Performance Curves

Isolation between RF1 to RF4, RFC to RF2 On¹¹

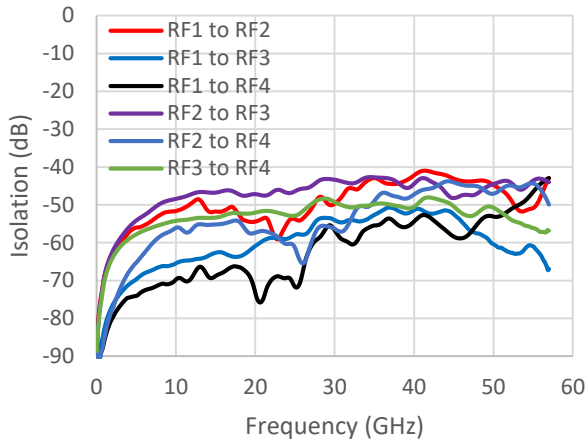

Isolation between RF1 to RF4, RFC to RF3 On¹¹

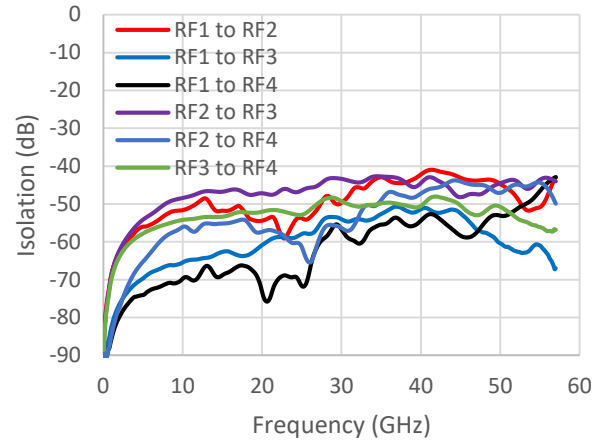

Input P0.1dB

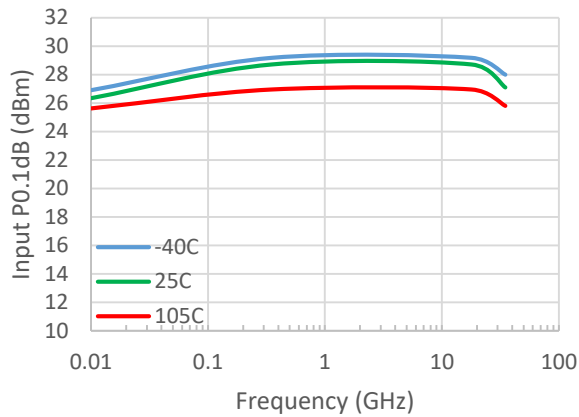

Input P1dB

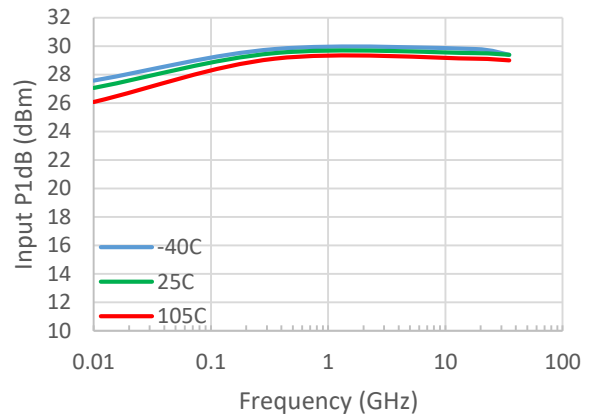

Input IP3¹³

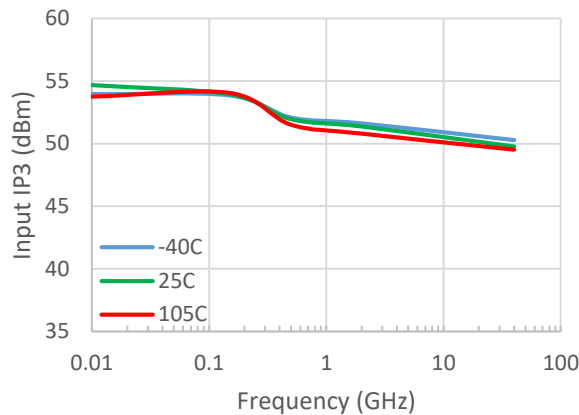

13. Input IP3 were measured using connectorized evaluation board with impedance matching. The RF input power was 14 dBm per tone with spacing of 1 MHz.

Lead Free 3 mm 22-Lead Laminate Package †

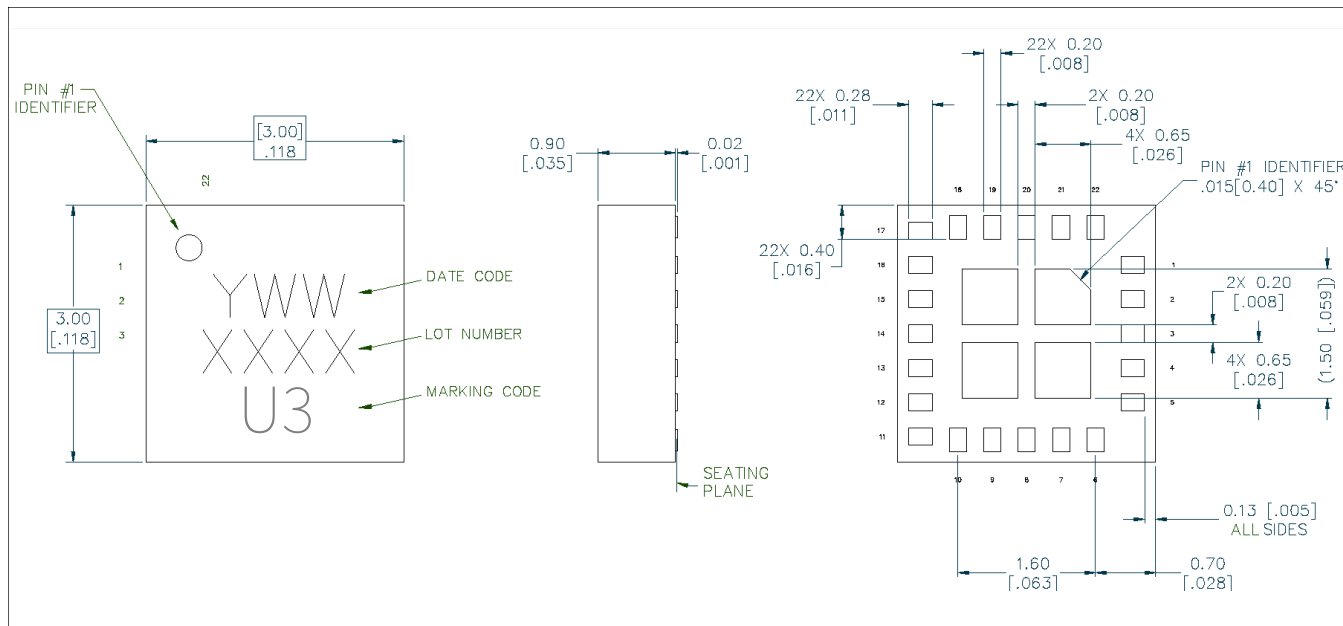

† Reference Application Note S2083 for lead-free solder reflow recommendations.
The part requires the use of "activated" flux.
Meets JEDEC moisture sensitivity level 3 requirements.
Plating is 100% matte tin over copper.