

## 3 Watt Cellular T/R and Antenna Changeover Switch DC - 3.0 GHz

Rev. V5

### Features

- Low Insertion Loss: < 0.4 dB @ 1900 MHz
- Low Current Consumption: <20  $\mu$ A @ +5V
- High Intercept Point: 58 dBm @ 1 GHz
- Positive or Negative Voltage Control
- CDMA, W-CDMA, TDMA, GSM, PCS and DCS
- Lead-Free Plastic SOT-26 Package
- Halogen-Free "Green" Mold Compound
- 260°C Reflow Compatible
- RoHS\* Compliant Version of SW-425

### Description

The MASWSS0143 is a GaAs monolithic switch in a lead-free, SOT-26 surface mount plastic package. This device is ideally suited for applications where very low power consumption, low intermodulation products and very small size are required.

Typical applications include internal / external antenna select switch for portable telephones and data radios. In addition because of its low loss, good isolation, and inherent speed, the MASWSS0143 can be used as a conventional T/R switch or as an antenna diversity switch.

The MASWSS0143 can be used in power applications up to 3 watts in systems such as cellular PCS, CDMA, W-CDMA, TDMA, GSM and other analog / digital wireless communications systems.

The MASWSS0143 is fabricated using a 0.5 micron gate length GaAs pHEMT process. The process features full chip passivation for increased performance and reliability.

### Ordering Information <sup>1</sup>

Part Number	Package
MASWSS0143	Bulk Packaging
MASWSS0143TR	1000 piece reel
MASWSS0143TR-3000	3000 piece reel

1. Reference Application Note M513 for reel size information.

### Functional Block Diagram

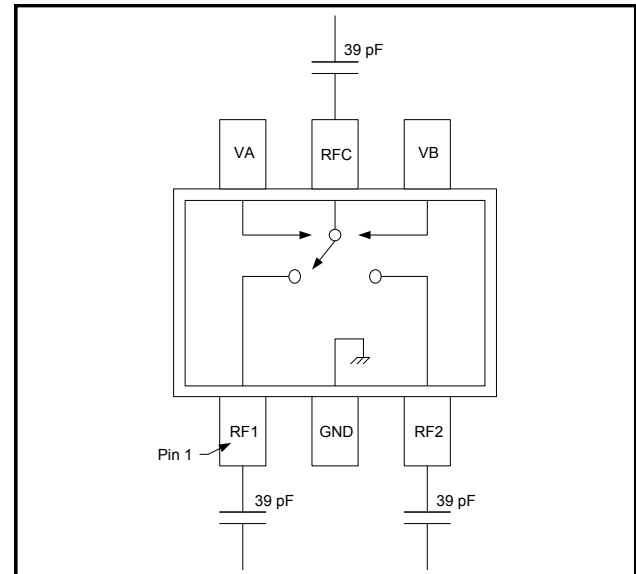

### Pin Configuration

Pin No.	Function	Description
1	RF1	RF In/Out
2	GND	RF Ground
3	RF2	RF In/Out
4	VB	Voltage Control B
5	RFC	RF Common
6	VA	Voltage Control A

### Absolute Maximum Ratings <sup>2,3</sup>

Parameter	Absolute Maximum
Input Power (1 GHz) 5 V Control	+36 dBm
Operating Temperature	-40°C to +85°C
Storage Temperature	-65°C to +150°C

2. Exceeding any one or combination of these limits may cause permanent damage to this device.
3. M/A-COM Technology does not recommend sustained operation near these survivability limits.

\* Restrictions on Hazardous Substances, European Union Directive 2002/95/EC.

## 3 Watt Cellular T/R and Antenna Changeover Switch DC - 3.0 GHz

Rev. V5

Electrical Specifications:  $T_A = 25^\circ\text{C}$ ,  $V_{CTL} = 0/5\text{ V}$ ,  $P_{IN} = 30\text{ dBm}$ ,  $Z_0 = 50\ \Omega^4$

Parameters	Test Conditions	Units	Min.	Typ.	Max.
Insertion Loss	DC - 1 GHz	dB	—	0.35	0.50
	1 - 2 GHz	dB	—	0.40	—
	2 - 3 GHz	dB	—	0.65	—
Isolation	DC - 1 GHz	dB	18	22	—
	1 - 2 GHz	dB	—	16	—
	2 - 3 GHz	dB	—	11	—
VSWR	DC - 3 GHz	Ratio	—	1.2:1	—
P1dB	1 GHz	dBm	—	36	—
IP2	2-Tone, 5 MHz Spacing, 1 GHz Pin = +10 dBm / Tone	dBm	—	110	—
IP3	2-Tone, 5 MHz Spacing, 1 GHz Pin = +10 dBm / Tone	dBm	—	58	—
2nd Harmonics	Pin = +30 dBm, $f_0 = 1\text{ GHz}$	dBc	—	-78	—
3rd Harmonics	Pin = +30 dBm, $f_0 = 1\text{ GHz}$	dBc	—	-82	-70
Trise, Tfall	10% to 90% RF, 90% to 10% RF	ns	—	20	—
Ton, Toff	50% control to 90% RF, 50% control to 10% RF	ns	—	60	—
Transients		mV	—	20	—
Control Current	$V_{CTL} = 5\text{ V}$	mA	—	5	20

4. For positive voltage control, external DC blocking capacitors are required on all RF ports.

### Truth Table <sup>5,6</sup>

Control A	Control B	RFC - RF1	RFC - RF2
0	1	Off	On
1	0	On	Off

5. Differential voltage,  $V$  (state 1) -  $V$  (state 0), must be +2.5 V minimum and must not exceed 8 V.

6. 0 = -8 V to 0 V, 1 = -5.5 V to 8.0 V

### Handling Procedures

Please observe the following precautions to avoid damage:

### Static Sensitivity

Gallium Arsenide Integrated Circuits are sensitive to electrostatic discharge (ESD) and can be damaged by static electricity. Proper ESD control techniques should be used when handling these devices.

### Lead-Free SOT-26<sup>†</sup>

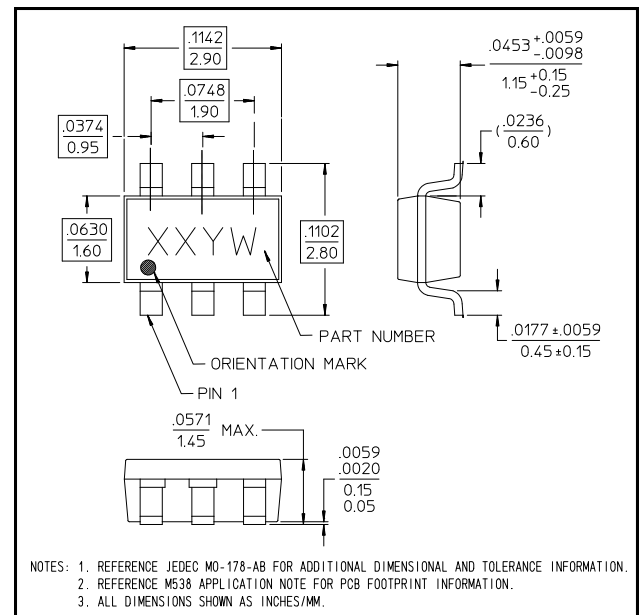

<sup>†</sup> Reference Application Note M538 for lead-free solder reflow recommendations.

Plating is 100% matte tin over copper.

## 3 Watt Cellular T/R and Antenna Changeover Switch DC - 3.0 GHz

Rev. V5

### Typical Performance Curves

**Insertion Loss, 1000 pF**

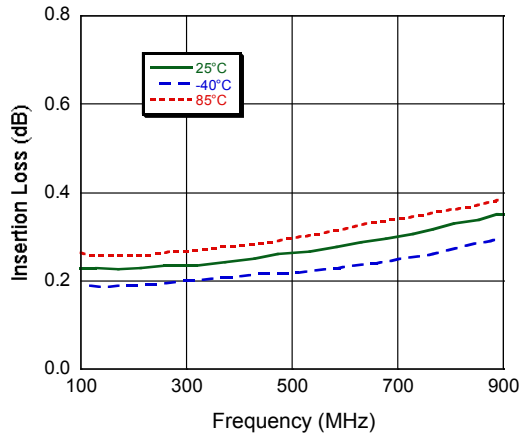

**Insertion Loss, 39 pF**

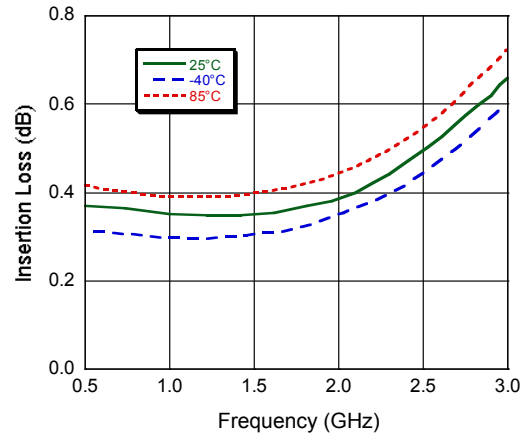

**Isolation, 1000 pF**

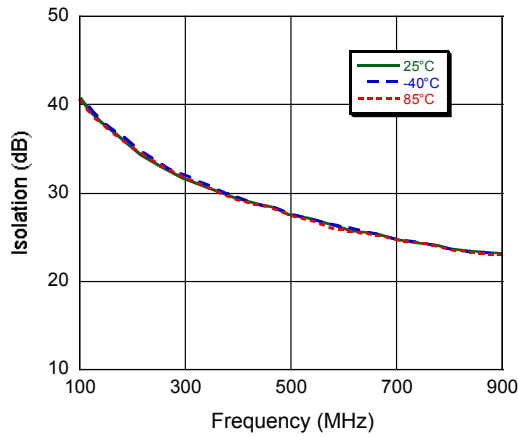

**Isolation, 39 pF**

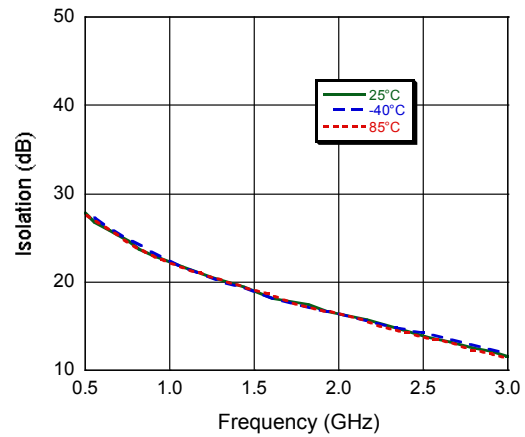

**VSWR, 1000 pF**

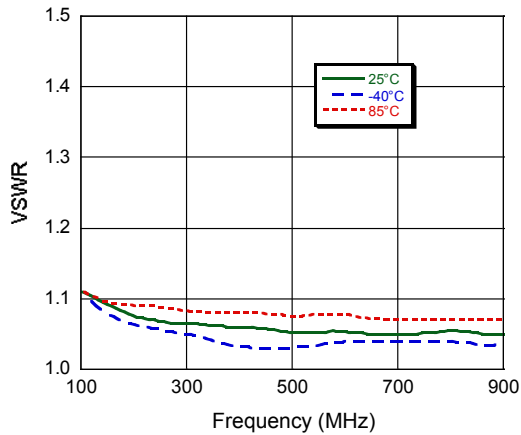

**VSWR, 39 pF**

