

Features

- Dedicated RF Ports (GSM, CDMA, GPS)
- Low Cross Modulation: -105 dBm
- Low Insertion Loss: 0.6 dB at 2 GHz
- High Isolation: 24 dB at 2 GHz
- Lead-Free 3 mm 12-lead PQFN Package
- 100% Matte Tin Plating over Copper
- Halogen-Free “Green” Mold Compound
- RoHS* Compliant and 260°C Reflow Compatible

Description

M/A-COM's MASWSS0144 is an industry leading GaAs PHEMT single pole, three throw (SP3T) switch in a lead-free 3 mm 12-lead PQFN package.

The MASWSS0144 is uniquely configured to enable switching from a common antenna port to Dual Band GSM, CDMA Cellular and PCS, or GPS Receive ports. The design is asymmetric and has dedicated paths for each mode, which allows each path to be optimized for the assigned mode of operation.

The MASWSS0144 is fabricated using a 0.5 micron gate length GaAs PHEMT process. The process features full passivation for performance and reliability.

Ordering Information

Part Number	Package
MASWSS0144	Bulk Packaging
MASWSS0144TR-3000	3000 piece reel
MASWSS0144SMB	Sample Test Board

Note: Reference Application Note M513 for reel size information.

Functional Schematic

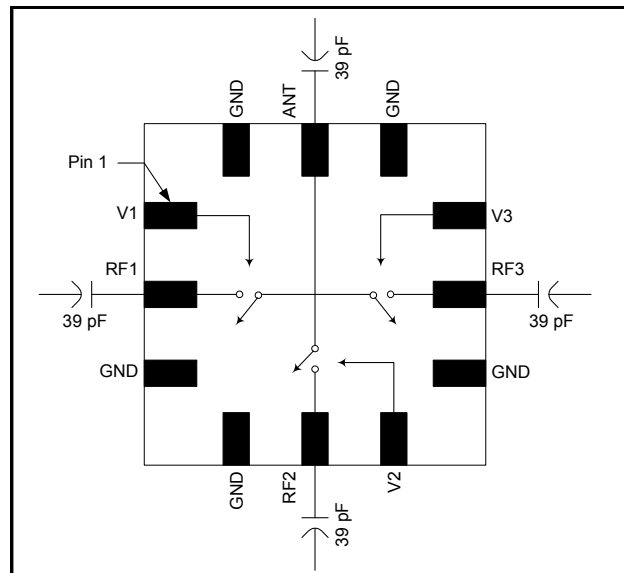

Pin Configuration

Pin No.	Pin Name	Description
1	V1	Control 1
2	RF1	CDMA Transmit/Receive Port
3	GND	RF Ground
4	GND	RF Ground
5	RF2	GSM Transmit/Receive Port
6	V2	Control 2
7	GND	RF Ground
8	RF3	CDMA and GPS
9	V3	Control 3
10	GND	RF Ground
11	ANT	Antenna Port
12	GND	RF Ground
13	GND (paddle) ¹	RF Ground

1. The exposed pad centered on the package bottom must be connected to RF and DC ground.

¹ * Restrictions on Hazardous Substances, European Union Directive 2002/95/EC.

2.7 V GaAs SP3T Switch: GSM - CDMA - GPS DC - 3.0 GHz

Rev. V1

Electrical Specifications: $T_A = 25^\circ\text{C}$, $V_C = 0\text{ V}$, 2.7 V, Pin = +34 dBm, $Z_0 = 50\ \Omega$ ²

Parameter	Test Conditions	Units	Min.	Typ.	Max.
Insertion Loss ³ RF1 and RF2 Paths	1 GHz	dB	—	0.60	0.75
	1-2 GHz	dB	—	0.60	—
	2-3 GHz	dB	—	0.65	—
Insertion Loss ³ RF3 Path	1 GHz	dB	—	0.65	0.85
	1-2 GHz	dB	—	0.65	—
	2-3 GHz	dB	—	0.75	—
Isolation All Paths	0.5-1 GHz	dB	25	30	—
	1-2 GHz	dB	—	24	—
	2-3 GHz	dB	—	19	—
Return Loss (All RF ports)	0.5-3 GHz	dB	—	21	—
Cross Modulation RF1 Path	Cell Band: CDMA TX = +25 dBm @ 820 MHz, RX _{INT} = -23 dBm @ 865 MHz	dBm	—	-102	—
	PCS Band: CDMA TX = +20 dBm @ 1950 MHz, RX _{INT} = -23 dBm @ 1870 MHz	dBm	—	-105	—
2nd Harmonic RF2 Path	GSM Band: Pin = 34 dBm	dBc	—	-75	—
	DCS/PCS Band: Pin = 32 dBm	dBc	—	-75	—
3rd Harmonic RF2 Path	GSM Band: Pin = 34 dBm	dBc	—	-72.5	-70
	DCS/PCS Band: Pin = 32 dBm	dBc	—	-68.0	—
P0.1dB RF1 & RF2 Paths	$V_C = 2.7\text{ V}$	dBm	—	36.0	—
	$V_C = 5.0\text{ V}$	dBm	—	37.5	—
IP2	Two Tone, +18 dBm / Tone, 1 MHz spacing, >50 MHz	dBm	—	70	—
IP3	Two Tone, +18 dBm / Tone, 1 MHz spacing, >50 MHz	dBm	—	55	—
Trise, Tfall	10% to 90% RF, 90% to 10% RF	nS	—	50	—
Ton, Toff	50% control to 90% RF, and 50% control to 10% RF	nS	—	70	—
Transients	In Band	mV	—	10	—
Control Current	$ V_C = 2.7\text{ V}$	μA	—	10	25

- For positive voltage control, external DC blocking capacitors are required on all RF ports.
- Insertion Loss can be optimized by varying the DC blocking capacitor value, e.g. 1000 pF for 100 MHz - 500 MHz, 100 pF for 0.5 GHz - 2.5 GHz. The low frequency response will be determined by the capacitor value used.

Truth Table ⁴

V1	V2	V3	ANT- RF1	ANT - RF2	ANT - RF3
1	0	0	On	Off	Off
0	1	0	Off	On	Off
0	0	1	Off	Off	On

- 1 = 2.7 V to 5.0 V, 0 = 0 V \pm 0.2 V

Absolute Maximum Ratings ^{5,6}

Parameter	Absolute Maximum
Input Power (0.5 - 2.5 GHz, 2.7 V Control)	+36 dBm
Operating Voltage	+8.5 volts
Operating Temperature	-40°C to +85°C
Storage Temperature	-65°C to +150°C

- Exceeding any one or combination of these limits may cause permanent damage to this device.
- M/A-COM does not recommend sustained operation near these survivability limits.

Typical Performance Curves (using 39 pF external DC blocking capacitors)

RF1 Insertion Loss

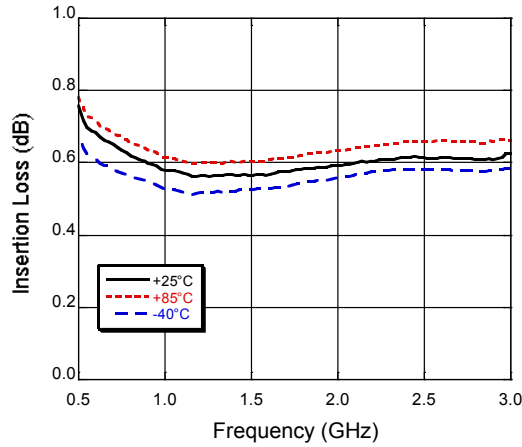

RF2 Insertion Loss

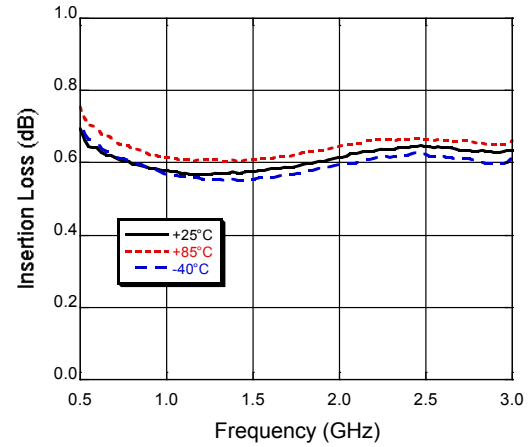

RF3 Insertion Loss

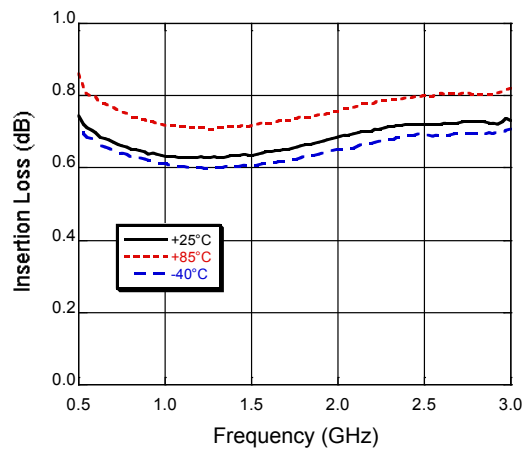

RF1 Isolation

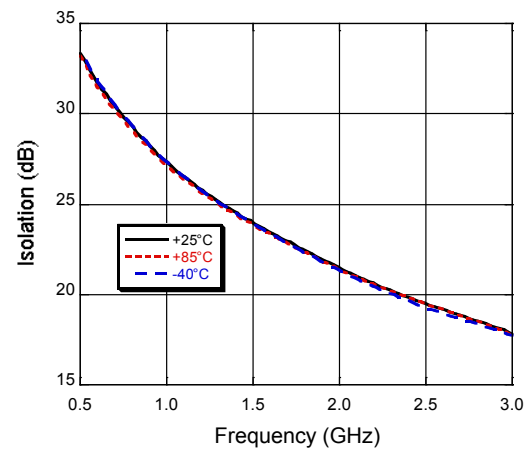

RF2 Isolation

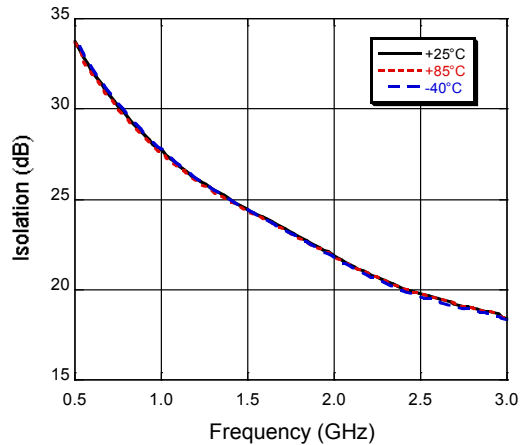

RF3 Isolation

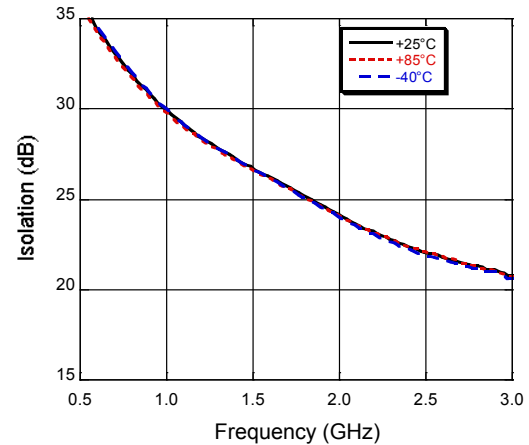

2.7 V GaAs SP3T Switch: GSM - CDMA - GPS DC - 3.0 GHz

Rev. V1

Typical Performance Curves (using 39 pF external DC blocking capacitors)

Return Loss

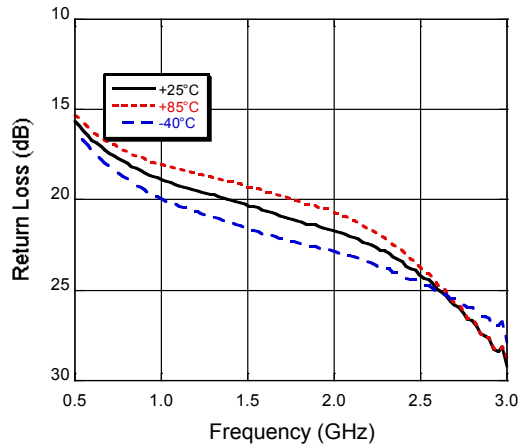

Qualification

Qualified to M/A-COM specification REL-201, Process Flow -2.

Handling Procedures

Please observe the following precautions to avoid damage:

Static Sensitivity

Gallium Arsenide Integrated Circuits are sensitive to electrostatic discharge (ESD) and can be damaged by static electricity. Proper ESD control techniques should be used when handling these devices.

Lead-Free 3 mm 12-lead PQFN†

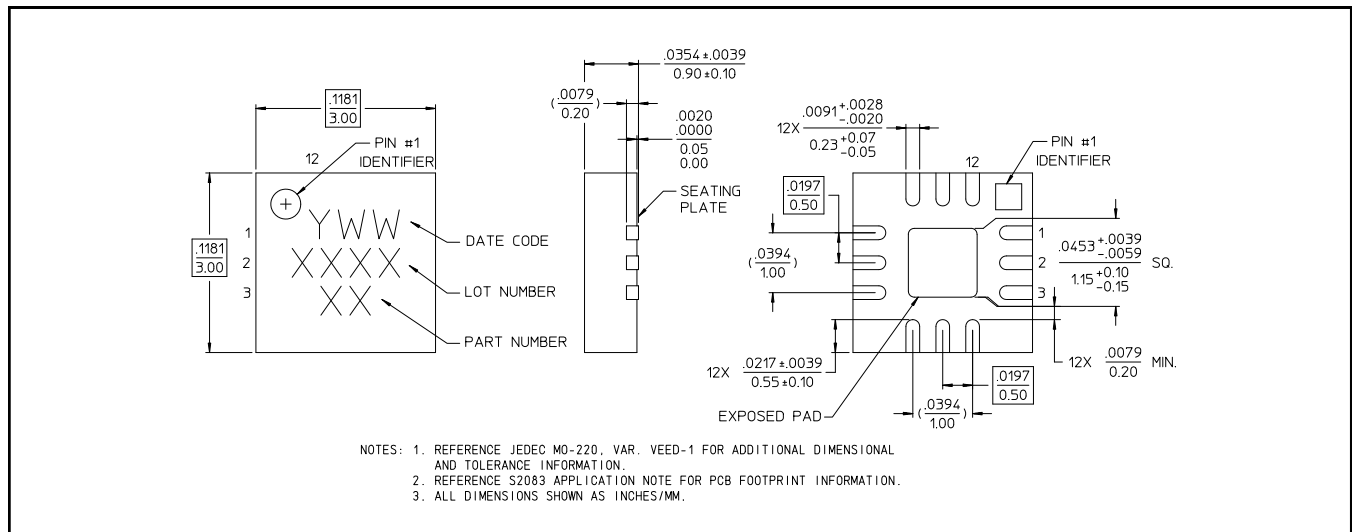

† Reference Application Note M538 for lead-free solder reflow recommendations.