

General Description

The evaluation kit (EV kit) demonstrates the MAX1121X family of 24-bit, 64ksps delta-sigma ADCs with integrated PGA. The EV kit includes a graphical user interface (GUI) that provides communication from the target device to the PC. The EV kit can operate in multiple modes:

- 1) **Standalone Mode:** In “Standalone” mode, the EV kit is connected to the PC through a USB cable and performs a subset of the complete EV kit functions with limitation for sample rate and size.
- 2) **FPGA Mode:** In “FPGA” mode, the EV kit is connected to an Avnet ZedBoard™ through a low-pin-count FMC connector. ZedBoard features a Xilinx® Zynq®-7000 SoC that connects to the PC through an Ethernet port, which allows the GUI to perform different operations with full control over mezzanine card functions. The EV kit with FPGA platform performs the complete suite of evaluation tests for the target IC
- 3) **User-Supplied SPI Mode:** In addition to the USB and FMC interfaces, the EV kit provides two 12-pin PMOD-style headers for user-supplied SPI interface, to connect the signals for RDYB, SCLK, DIN, DOUT, and CSB.

The EV kit includes Windows XP®, Windows® 7 and Windows 8.1-compatible software to exercise the features of the IC. The EV kit GUI allows different sample sizes, adjustable sampling rates, on-board or external reference options, and graphing software that includes the FFT and histogram of the sampled signals with the ability to save plots in .jpg or .csv formats.

The ZedBoard board accepts a +12V AC-DC wall adapter. The EV kit can be powered by the ZedBoard or by a local 12V supply. The EV kit has on-board transformers and digital isolators to separate the IC from the ZedBoard/on-board processor.

The MAX11214 EV kit comes installed with a MAX11214EUG+ in a 24-pin TSSOP package and the MAX11216 EV kit comes installed with a MAX11216EUG+ in a 24-pin TSSOP package.

Features and Benefits

- High-Speed USB, FMC Connector, and PMOD Connector
- 5MHz SPI Interface
- Various Sample Sizes and Sample Rates
- Collects Up to 1 Million Samples (with FPGA Platform)
- Time Domain, Frequency Domain, and Histogram Plotting
- Save Plots as jpg, bmp or csv
- Sync In and Sync Out for Coherent Sampling (with FPGA Platform)
- On-Board DAC (MAX542) for DC Signal-Level Generation
- On-Board Voltage Reference (MAX6126)
- Proven PCB Layout
- Fully Assembled and Tested
- Windows XP-, Windows 7-, and Windows 8.1-Compatible Software
- Savable ADC Configurations

Ordering Information appears at end of data sheet.

ZedBoard is a trademark of Avnet, Inc.

Xilinx and Zynq are registered trademarks and Xilinx is a registered service mark of Xilinx, Inc.

Windows and Windows XP are registered trademarks and registered service marks of Microsoft Corporation.

MAX1121X EV Kit Photo

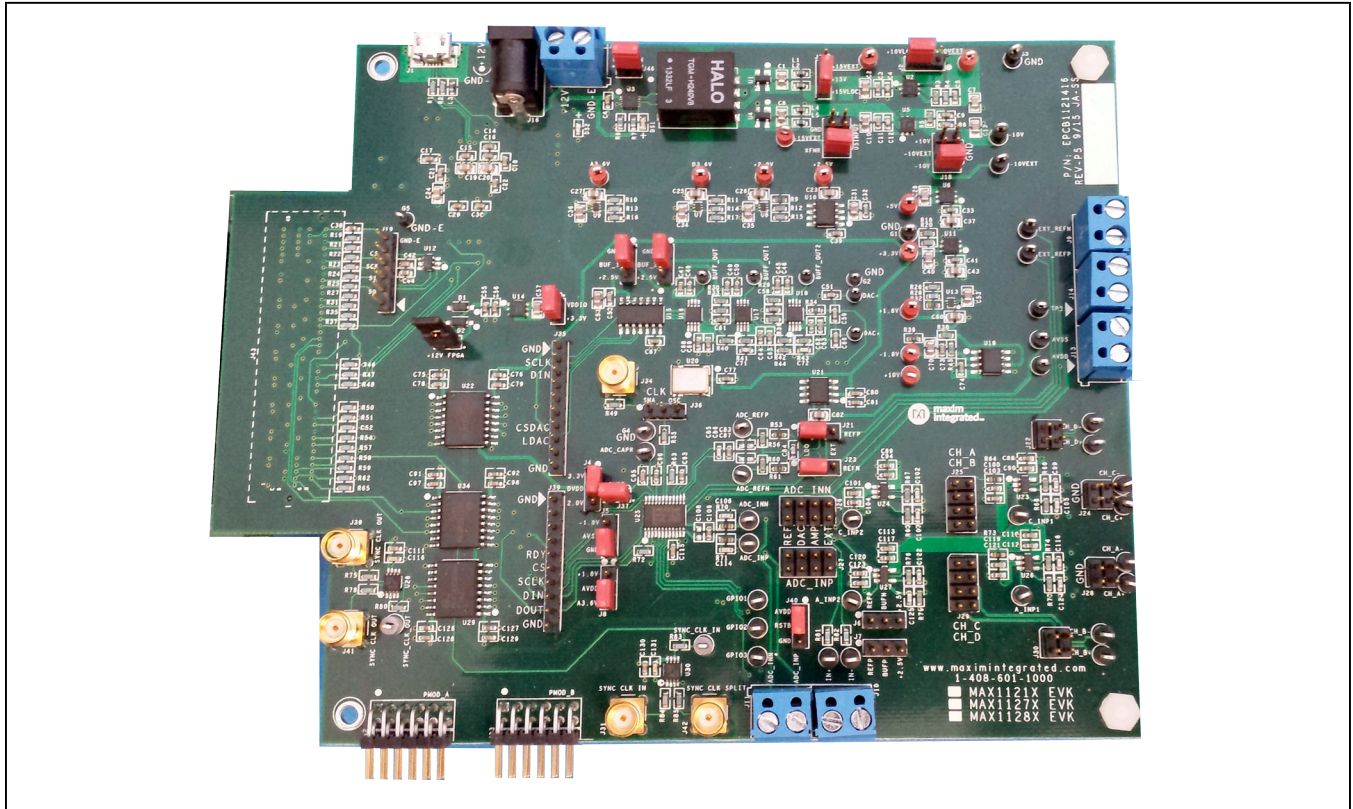

System Block Diagram

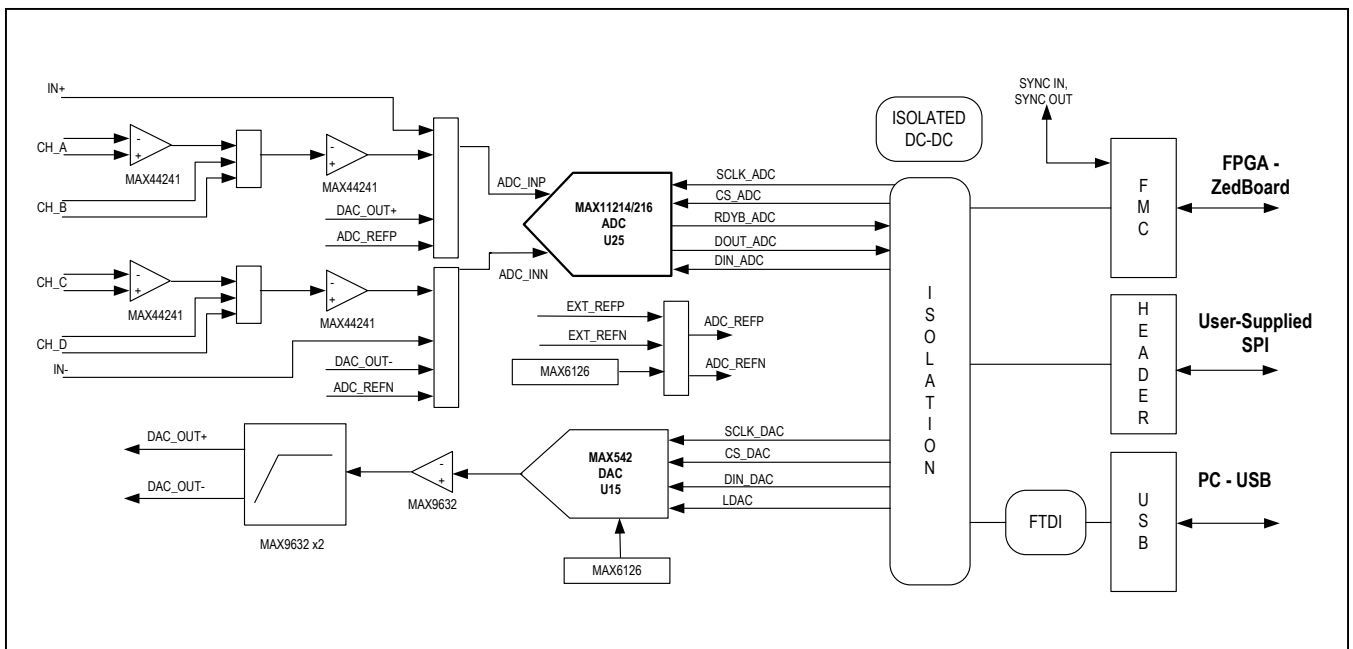

MAX1121X EV Kit Files

FILE	DESCRIPTION
MAX11214_16EVKitSetupV1.1.exe	Application Program (GUI)
Boot.bin	ZedBoard Firmware (SD Card to boot Zynq)

Quick Start

Required Equipment

- MAX1121X EV kit
- +12V (500mA) power supply
- Micro-USB cable
- ZedBoard development board (optional – **Not Included** with EV kit)
- Function generator (optional)
- Windows XP, Windows 7, or Windows 8.1 PC with a spare USB port

Note: In the following sections, software-related items are identified by bolding. Text in **bold** refers to items directly from the EV system software. Text in **bold and underline** refers to items from the Windows operating system.

Procedure

The EV kit is fully assembled and tested. Follow the steps below to verify board operation:

- 1) Visit www.maximintegrated.com/evkitsoftware to download the latest version of the EV kit software, MAX11214_16EVK.ZIP. Save the EV kit software to a temporary folder and uncompress the ZIP file.
- 2) Install the EV kit software and USB driver on your computer by running the MAX11214_16EVKitSetupV1.1.exe program inside the temporary folder. The program files are copied to your PC and icons are created in the Windows **Start | Programs** menu. At the end of the installation process, the installer will launch the installer for the FTDIChip CDM drivers.

For Standalone mode:

- 3) Verify that all jumpers are in their default positions for the EV kit ([Table 2](#)).
- 4) Connect the PC to the EV kit using a micro-USB cable.
- 5) Connect the +12V adapter to the EV kit.
- 6) Start the EV kit software by opening its icon in the **Start | Programs** menu. The EV kit software appears as shown in [Figure 1](#). Verify that the lower left status bar indicates the EV kit hardware is **Connected**.

- 7) From the **Device** menu, select **Standalone** and click **Search for USB Device**. Then select **Standalone** again and select a device in the list. Verify that the lower left status bar indicates the EV kit hardware is **Connected**.

For FPGA mode (when connected to a ZedBoard):

- 8) Connect the Ethernet cable from the PC to the ZedBoard and configure the Internet Protocol Version 4 (TCP/Ipv4) properties in the local area connection to IP address 192.168.1.2 and subnet Mask to 255.255.255.0.
- 9) Verify that the ZedBoard SD card contains the boot.bin file for the MAX1121X EV kit.
- 10) Connect the EV kit FMC connector to the ZedBoard FMC connector. Gently press them together.
- 11) Verify that all jumpers are in their default positions for the ZedBoard ([Table 1](#)) and EV kit ([Table 2](#)).
- 12) Connect the 12V wall adapter power supply to the ZedBoard. Leave the ZedBoard powered off. Connect the PC to the ZedBoard with an Ethernet cable.
- 13) Enable the power supply by sliding SW8 to ON.
- 14) Start the EV kit software by opening its icon in the **Start | Programs** menu. The EV kit software appears as shown in [Figure 1](#). From the **Device** menu, select **FPGA**. Verify that the lower left status bar indicates the EV kit hardware is **Connected**.

For either Standalone or FPGA mode:

- 15) Connect the positive terminal of the function generator to the IN+ test point on the EV kit. Connect the negative terminal of the function generator to the IN- test point on the EV kit. Disable the function generator.
- 16) Enable the function generator. Configure the signal source to generate a 1kHz, 1V_{P-P} sinusoidal wave with +500mV offset.
- 17) In the **Calibration** group, select **Self Offset/Gain** in the drop-down list and then click **Calibrate**.
- 18) Click on the **Scope** tab.
- 19) Check the **Remove DC** checkbox to remove the DC component of the sampled data.
- 20) Click the **Capture** button to read sampled data from the ADC.
- 21) The EV kit software appears as shown in [Figure 4](#).
- 22) Verify the frequency is approximately 1kHz displayed on the right. The scope graph has buttons in the upper-right corner that allow zooming in to detail.

Table 1. ZedBoard Jumper Settings (Optional)

JUMPER	SHUNT POSITION	DESCRIPTION
J18	1-2	VDDIO set for 3.3V
JP11	2-3	Boot from SD card
JP10	1-2	
JP9	1-2	
JP8	2-3	
JP7	2-3	
JP10	—	
J12	—	SD card installed
J20	—	Connected to 12V wall adapter
SW8	Off	ZedBoard power switch, off while connecting boards

Table 2. MAX1121X EV Kit User Configuration Jumper Settings*

JUMPER	SHUNT POSITION	DESCRIPTION
J2 (Red)	1-2	Connects the +10V rail to test point +10VEXT for external power (op amp + supply)
	2-3*	Connects the +10V rail to LDO U2 (op amp + supply)
J3 (Red)	1-2	Connects the +15V rail to test point +15EXT for external power (powers U2)
	2-3*	Connects the +15V rail to isolation transformer (powers U2)
J4 (Red)	1-2	Set ADC DVDD to +3.3V
	2-3*	Set ADC DVDD to +2.0V
J5 (Red)	1-2*	Connect ADC AVSS to GND (unipolar mode – also set J8 for unipolar)
	2-3	Connect ADC AVSS to -1.8V (bipolar mode – also set J8 for bipolar)
J6 (Black)	1-2	Apply an offset of ADC_REFP (2.5V default) to amplifier U24
	2-3	Apply an offset of 2.5V to amplifier U24
	Open*	No offset for amplifier U24
J7 (Black)	1-2	Apply an offset of ADC_REFP (2.5V default) to amplifier U27
	2-3	Apply an offset of 2.5V to amplifier U27
	Open*	No offset for amplifier U27
J8 (Red)	1-2	Connect ADC AVDD to +1.8V (bipolar mode)
	2-3*	Connect ADC AVDD to 3.6V (unipolar mode)
J15 (Red)	1-2*	Connects ZedBoard +12V to main power supply (U3). Diode D2 protects supplies.
	Open	Disconnects ZedBoard +12V from main power supply
J17 (Red)	1-2	Connects U5 input to GND
	3-4	Connects U5 input to test point -15VEXT for external power
	5-6*	Connects U5 input to isolation transformer
J18 (Red)	1-2	Do not connect
	3-4	Do not connect
	5-6	Connects U5 output to GND, which sets the reference for the -10V supply (op amp - supply)
J20 (Red)	1-2*	Connects on-board FTDI chip to 3.3V, necessary for standalone mode
	Open	Disconnects on-board FTDI chip power. This jumper does not interfere with the ZedBoard.
J21 (Black)	1-2*	Drive ADC REFP pin with on-board voltage reference
	2-3	Drive ADC REFP pin with external voltage reference

Table 2. MAX1121X EV Kit User Configuration Jumper Settings* (continued)

JUMPER	SHUNT POSITION	DESCRIPTION
J22 (Black)	1-2	Ground test point CH_D-
	3-4	Ground test point CH_D+
J23 (Black)	1-2*	Drive ADC REFN pin with on-board voltage reference
	2-3	Drive ADC REFN pin with external voltage reference
J24 (Black)	1-2	Ground test point CH_C-
	3-4	Ground test point CH_C+
J25 (Black)	1-2*	Connect output of U23 (CH_C) to U24 inverting input
	3-4	Connect CH_D- to U24 inverting input
	5-6	Connect output of U23 (CH_C) to U24 noninverting input
	7-8	Connect CH_D+ to U24 noninverting input
J26, J27 (Black)	1-2*	Set both jumpers to align with silkscreen text "EXT" to drive ADC_INP and ADC_INN with test points IN+ and IN- (also external connector J10 is on same net)
	3-4	Set both jumpers to align with silkscreen text "AMP" to drive ADC_INP and ADC_INN with U27 and U24 amplifiers
	5-6	Set both jumpers to align with silkscreen text "DAC" to drive ADC_INP and ADC_INN with DAC_OUT+ and DAC_OUT-
	7-8	Set both jumpers to align with silkscreen text "REF" to drive ADC_INP and ADC_INN with ADC_REFP and ADC_REFN voltage reference
	9-10	ADC_INP to ADC_REF/2, ADC_INN to GND
J28 (Black)	1-2	Ground test point CH_A-
	3-4	Ground test point CH_A+
J29 (Black)	1-2*	Connect output of U26 (CH_A) to U27 inverting input
	3-4	Connect CH_B- to U27 inverting input
	5-6	Connect output of U26 (CH_A) to U27 noninverting input
	7-8	Connect CH_B+ to U27 noninverting input
J30 (Black)	1-2	Ground test point CH_B-
	3-4	Ground test point CH_B+
J36 (Black)	1-2	Drive ADC CLK pin with signal from SMA connector J34
	2-3*	Drive ADC CLK pin with signal from on-board oscillator U20
J37 (Red)	1-2*	Connect ADC to the DVDD voltage selection jumper J4
	open	Attach amp meter between pins 1-2 to measure current consumed by ADC DVDD
J40 (Black)	1-2*	Connect ADC RST to DVDD (normal operation)
	2-3	Connect ADC RST to GND (reset state)
J44 (Black)	1-2*	Sets U18 noninverting input to 0V. Gain = -1 with offset = 0. Drives DAC_OUT-.
	2-3	Sets U18 noninverting input to 2.5V. Gain = -1 with offset = 2.5V. Drives DAC_OUT-.
J45 (Black)	1-2*	Sets U17 noninverting input to 0V. Gain = -1 with offset = 0. Drives DAC_OUT+.
	2-3	Sets U17 noninverting input to 2.5V. Gain = -1 with offset = 2.5V. Drives DAC_OUT+.
J46 (Red)	1-2*	Enables main power supply (U3)
	Open	Disables main power supply (U3)

*Red test points and red jumpers are used for power settings.

Black test points are used for ground points.

White test points are used for all signal points, black jumpers for signal settings.

Table 3. MAX1121X EV Kit User Off-Board Connectors

CONNECTOR REFERENCE DESIGNATOR	DESCRIPTION
J1	USB connector for standalone mode
J9	External reference input for EXT_REFP and EXT_REFN
J10	External input for ADC IN+ and IN-
J12, J16	External power connections, 12V. Both wall adapter and screw terminals are provided. When ZedBoard is used, these connectors are not necessary if jumper J15 is installed.
J13	External connections for AVDD and AVSS
J14	External enable, driven by GPIO1 via FET
J19	Serial EEPROM signal
J31	Sync clock input, SMA
J32	PMOD A, connects to ADC, 12-pin connector
J33	PMOD B, connects to DAC, 12-pin connector
J34	External clock input, SMA
J35	DAC SPI port signal
J38, J41	Sync clock out, SMA
J39	ADC SPI port signal
J42	Split sync clock in, SMA
J43	FMC connector for use with ZedBoard

General Description of Software

The main window of the EV kit software contains several tabs: ADC Config, DAC Config, Function Generator, Scope, DMM, Histogram, FFT, and ADC Registers. The ADC Config tab and ADC Registers tab provide control to communicate with the MAX1121X registers. The DAC Config tab and Function Generator tab provide control to communicate with the MAX542. The other four tabs are used for evaluating the sample data read from the ADC.

ADC Config Tab

The **ADC Config** tab provides an interface for configuring the IC from a functional perspective. The main block provides for calibration, GPIO control, input path selection, data format, filtering, power, and clocking. To read all the configuration settings, click the **Read All** button in

the **Serial Interface** block. When a setting is changed, the register associated with that setting is automatically written. The **Status Log** at the bottom of the GUI shows the value and register that was changed.

The primary mode for calibration is using the drop-down list to select a calibration mode, followed by clicking the **Calibrate** button. The checkboxes for **Self Offset**, **Self Gain**, **System Offset**, and **System Gain** allow for the user to enable or disable the calibration values. The calibration values can also be changed manually by entering a hex value in the SPI numeric box.

The **Power** block allows the user to put the part in a power-down or standby state by selecting one of these options in the drop-down list. The configuration settings can be reset back to default by clicking the **Reset**

Registers button. For the **Clock** source selection, the IC internal clock is always a valid option. If the external clock is selected, a clock must be applied at the IC CLK pin by setting jumper J36 to either SMA or OSC. Once the above configurations are completed, start conversion by clicking **Convert** in the **Serial Interface** block. To read the data and status, click **Read Data and Status** on the lower right of the GUI.

To save a configuration, select **Save ADC Config As...** in the **File** menu. This saves all the ADC register values to an XML file. To load a configuration, select **Load ADC Config** in the **File** menu. When the XML file is loaded, all the register values in the file are written to the ADC.

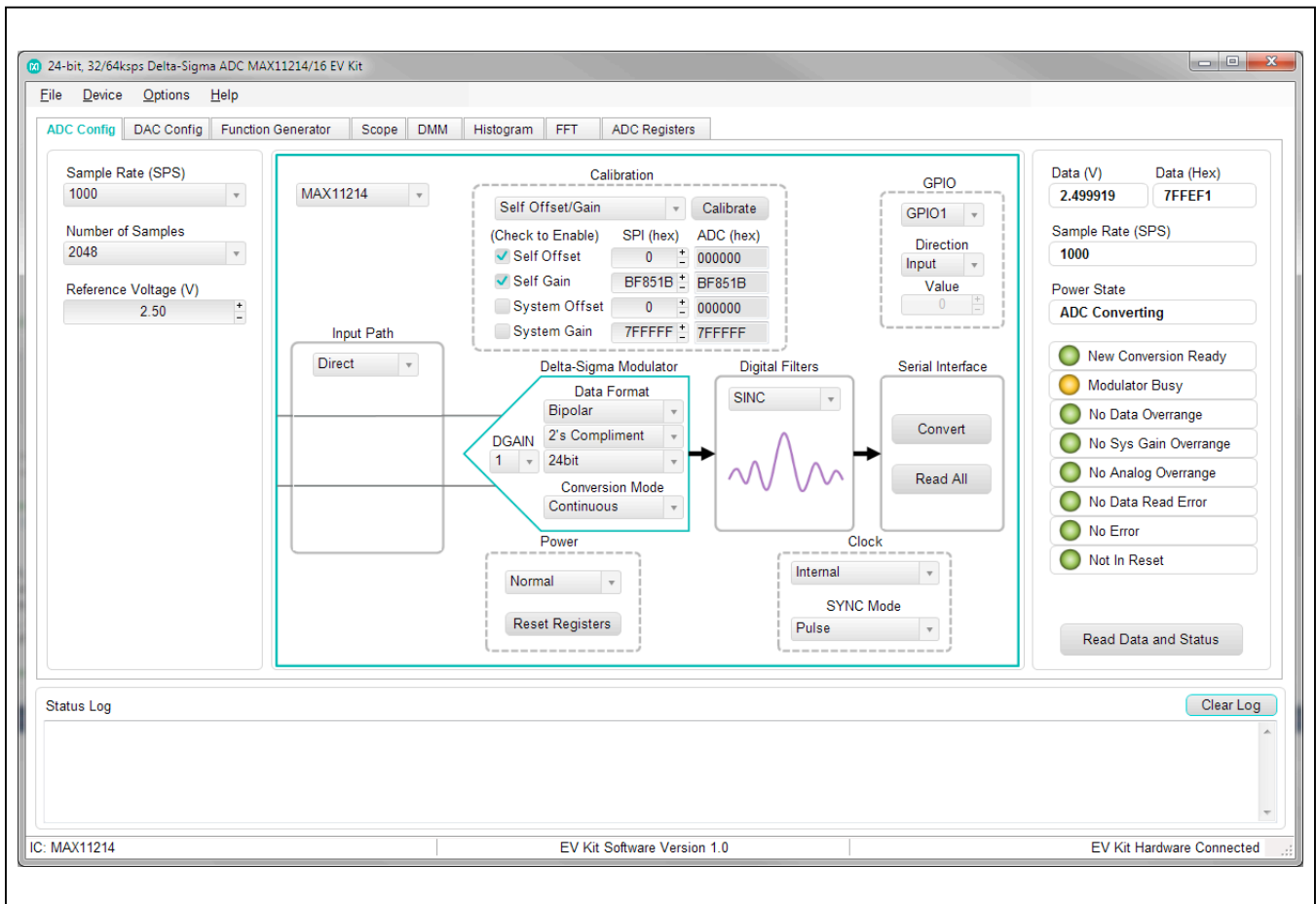

Figure 1. MAX1121X EV Kit Software (ADC Config Tab)

DAC Config Tab

In standalone mode, the ADC and DAC cannot operate concurrently. It is recommended to use FPGA mode when using the DAC for function generation. The **DAC Config** tab sheet provides an interface for configuring the MAX542 to drive the DAC_OUT+ and DAC_OUT- pins. Set J45 Offset and J44 Offset to match the jumper positions on the EV Kit. These jumper positions apply DC offset to DAC_OUT+ and DAC_OUT-, see the *DAC amplifier* section for more details. To write a value to the DAC, select the output of interest in the drop-down list, enter a value in the numeric box and then click **DAC Single Shot**. The outputs on the right display the voltage outputs and the decimal code written to the DAC.

The voltage outputs are calculated based on the DAC code and jumper offsets.

The **Calibration** section of the **DAC Config** tab can be used to calibrate the calculated voltages to be closer to the measured voltages. Select which output to calibrate with the radio buttons. Enter the maximum and minimum voltage for this output in the Ideal (V) numeric boxes. Find the measured voltages of the output for the maximum and minimum values using the **DAC Single Shot** to set the DAC output to the ideal voltages. Enter the measured voltages in the Measured (V) numeric boxes and click **Calculate** to find the new offset and gain. Check the **Enable Calibration** to use these values to calculate the voltage outputs.

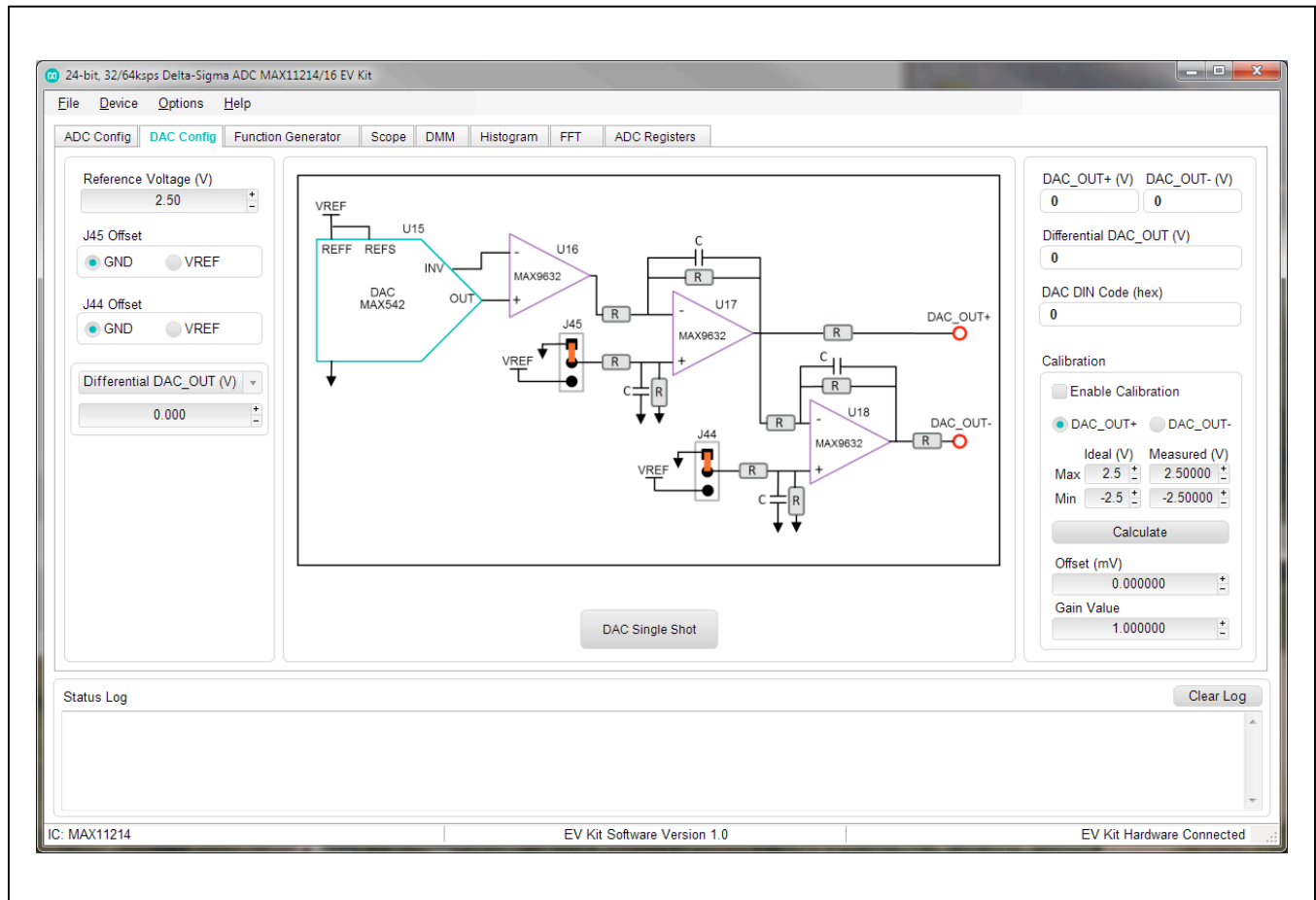

Figure 2. MAX1121X EV Kit Software (DAC Config Tab)

Function Generator

When using the FPGA mode, the **Function Generator** tab allows the user to generate a signal with the DAC. Select the Number of Samples, DAC Update Rate, and Signal Frequency. Click **Calculate** to get the Adjusted Frequency for the DAC signal needed for coherent sampling. Then select the Signal Type, Amplitude, Phase, and Offset to set up the waveform desired for the DAC. Click

Generate to find the DAC codes for the waveform and generate the waveform on the DAC. The waveform codes sent to the DAC is displayed on the graph. The Average, RMS, Maximum, Minimum, and Peak to Peak are also calculated and displayed on the right. To save the DAC code waveform, go to **Options > Save Graph > Function Generator**. This saves the settings on the left and the data in the graph to a csv file.

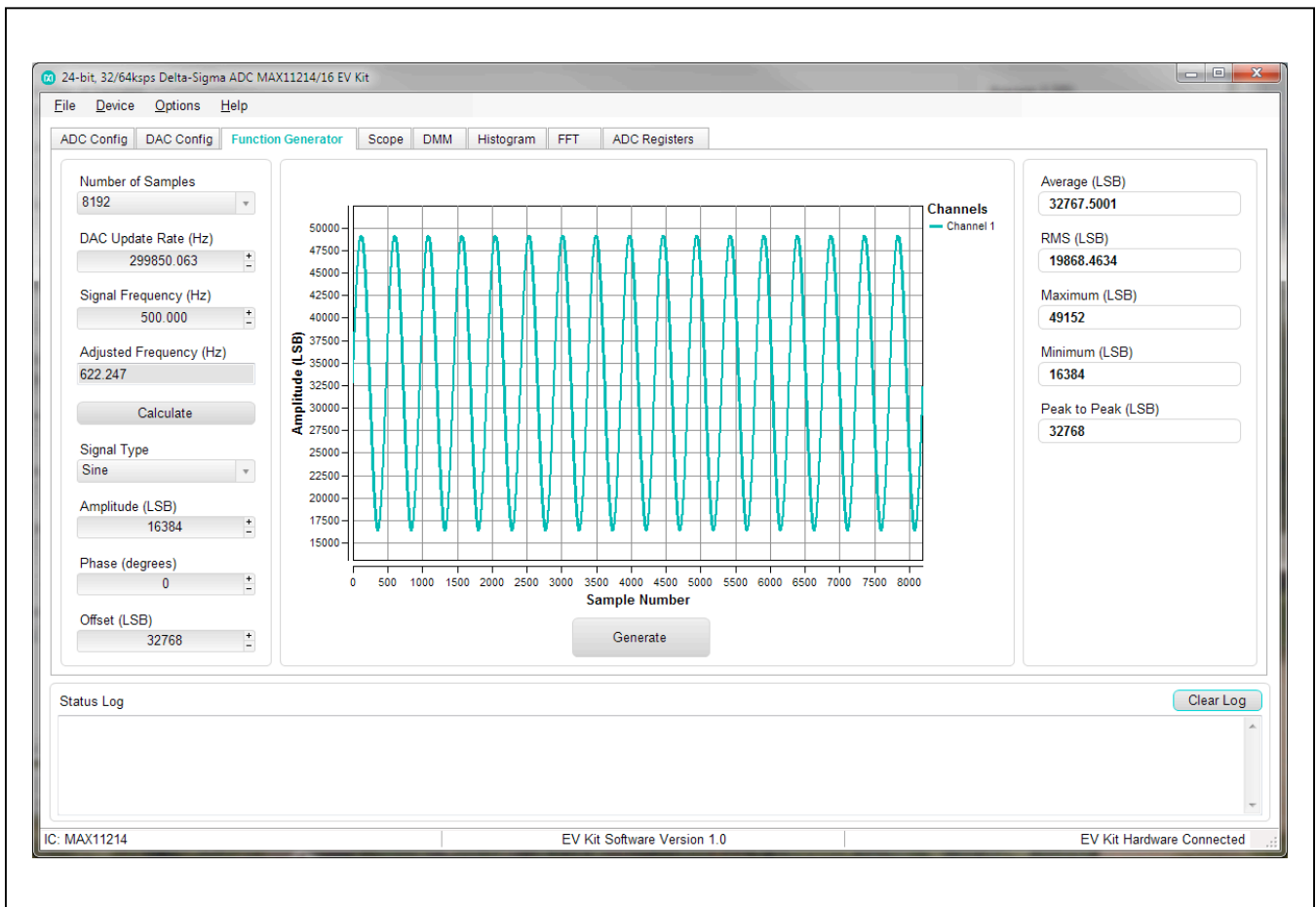

Figure 3. MAX1121X EV Kit Software (Function Generator Tab)

Scope Tab

The **Scope** tab sheet is used to capture data and display it in the time domain. **Sample Rate** and **Number of Samples** can also be set in this tab if they were not appropriately adjusted in other tabs. The **Display Unit** drop-down list allows counts and voltages. Once the desired configuration is set, click on the **Capture** button. The right side of the tab sheet displays details of the wave-

form, such as Average, Standard Deviation, Maximum, Minimum, and Fundamental Frequency. **Figure 4** displays the ADC data when a sinusoidal signal is applied at the inputs on the EV kit.

To save the captured data to a file, go to **Options > Save Graph > Scope**. This saves the setting on the left and the data captured to a csv file.

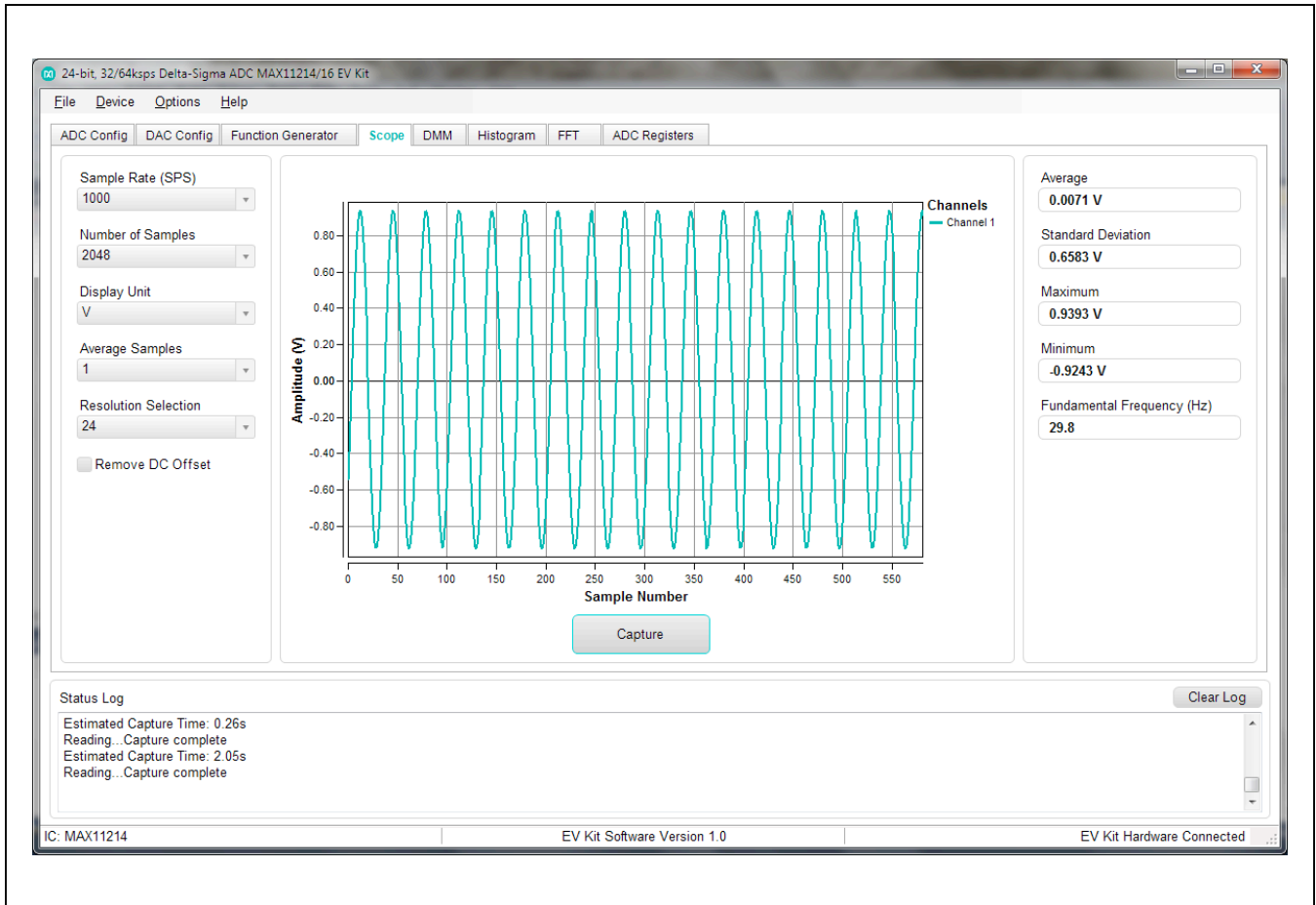

Figure 4. MAX1121X EV Kit Software (Scope Tab)

DMM Tab

The **DMM** tab sheet provides captured data as a digital multimeter. Once the desired configuration is set, click on the **Capture** button. [Figure 5](#) displays the results shown

by the **DMM** tab when ADC_INP and ADC_INN (J26 and J27 set as 7-8) are set to REF, see [Table 2](#) for jumper positions.

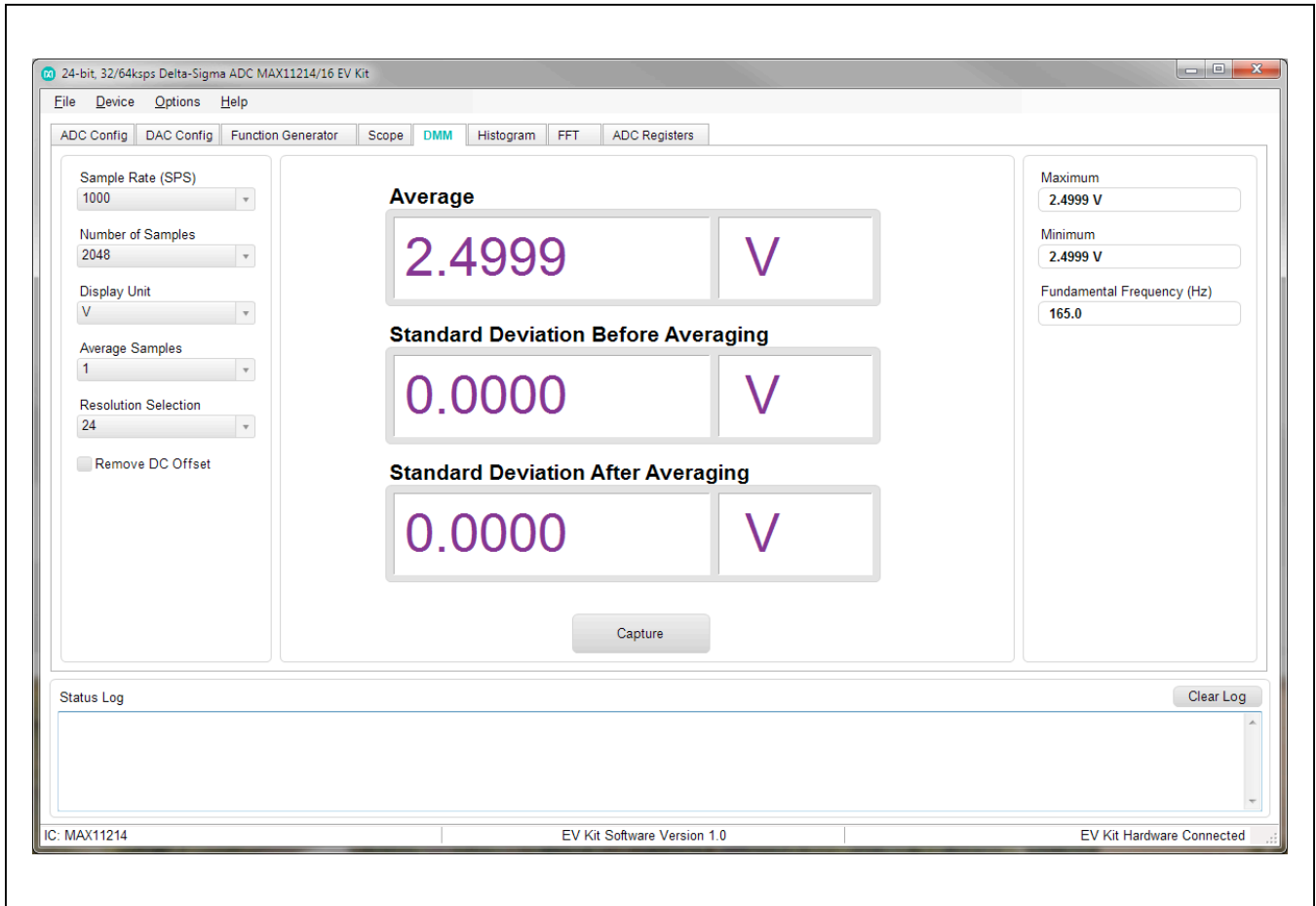

Figure 5. MAX1121X EV Kit Software (DMM Tab)

Histogram Tab

The **Histogram** tab sheet is used to display a histogram of the captured data. Sampling rate and number of samples can also be set in this tab if they were not appropriately adjusted in other tabs. Once the desired configuration is set, click on the **Capture** button. The right side of the tab sheet displays details of the histogram such as Average, Standard Deviation, Maximum, Minimum, Peak-to-Peak

Noise, Effective Resolution, and Noise-Free Resolution. To use this histogram feature, apply a DC voltage at the input. [Figure 5](#) displays the results shown by the **DMM** tab when ADC_INP and ADC_INN are set to REF, see [Table 2](#) for jumper positions.

To save the histogram data to a file, go to **Options > Save Graph > Histogram**. This saves the setting on the left and the histogram data captured to a csv file.

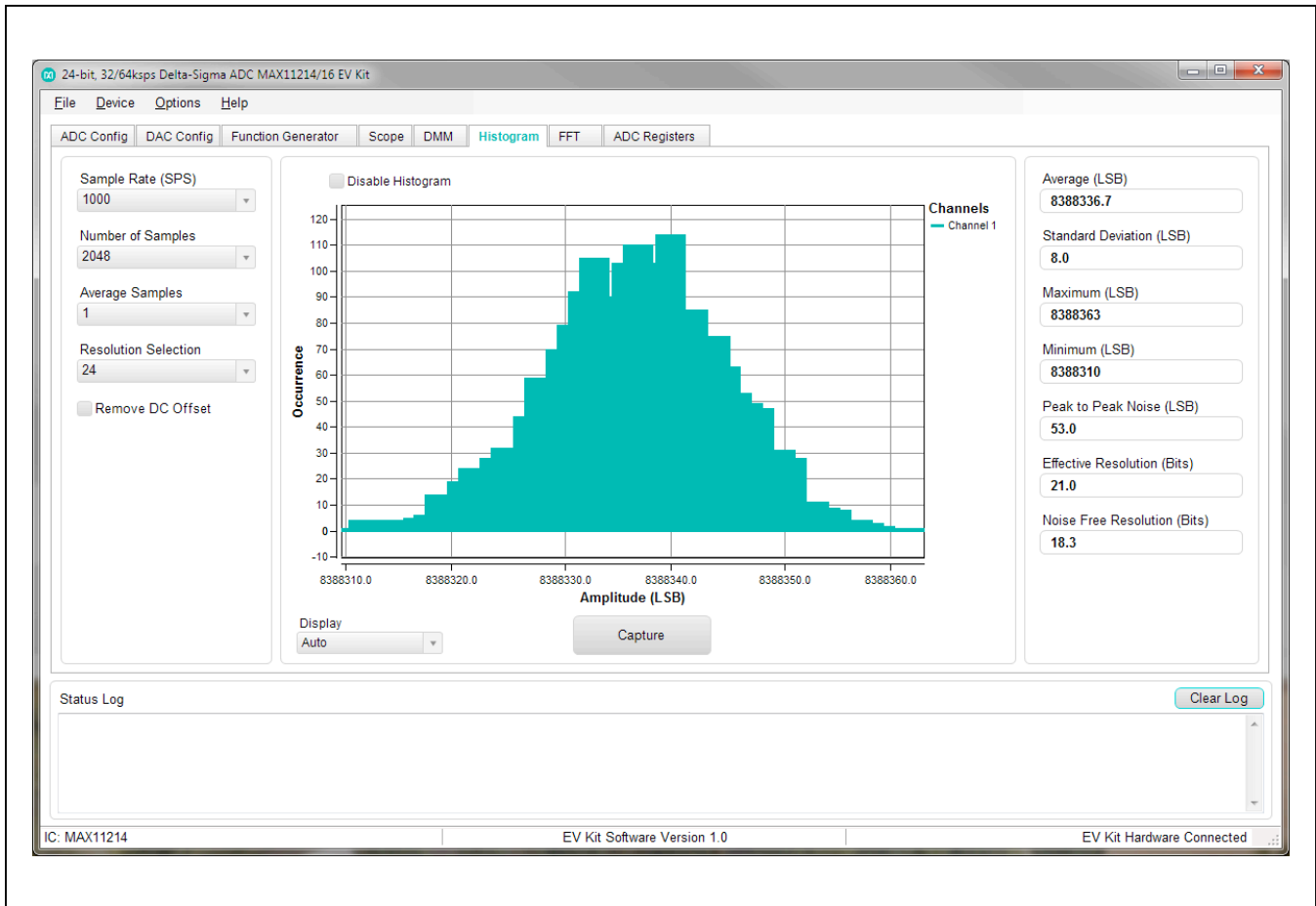

Figure 6. MAX1121X EV Kit Software (Histogram Tab)

FFT Tab

The **FFT** tab sheet is used to display the frequency domain FFT of the captured data. Sample Rate and Number of Samples can also be set in this tab if they were not appropriately adjusted in other tabs. Once the desired configuration is set, click on the **Capture** button. The right side of

the tab displays the performance based on the FFT, such as Fundamental Frequency, THD, SNR, SINAD, SFDR, ENOB, and Noise Floor.

To save the FFT data to a file, go to **Options > Save Graph > FFT**. This saves the setting on the left and the FFT data captured to a csv file.

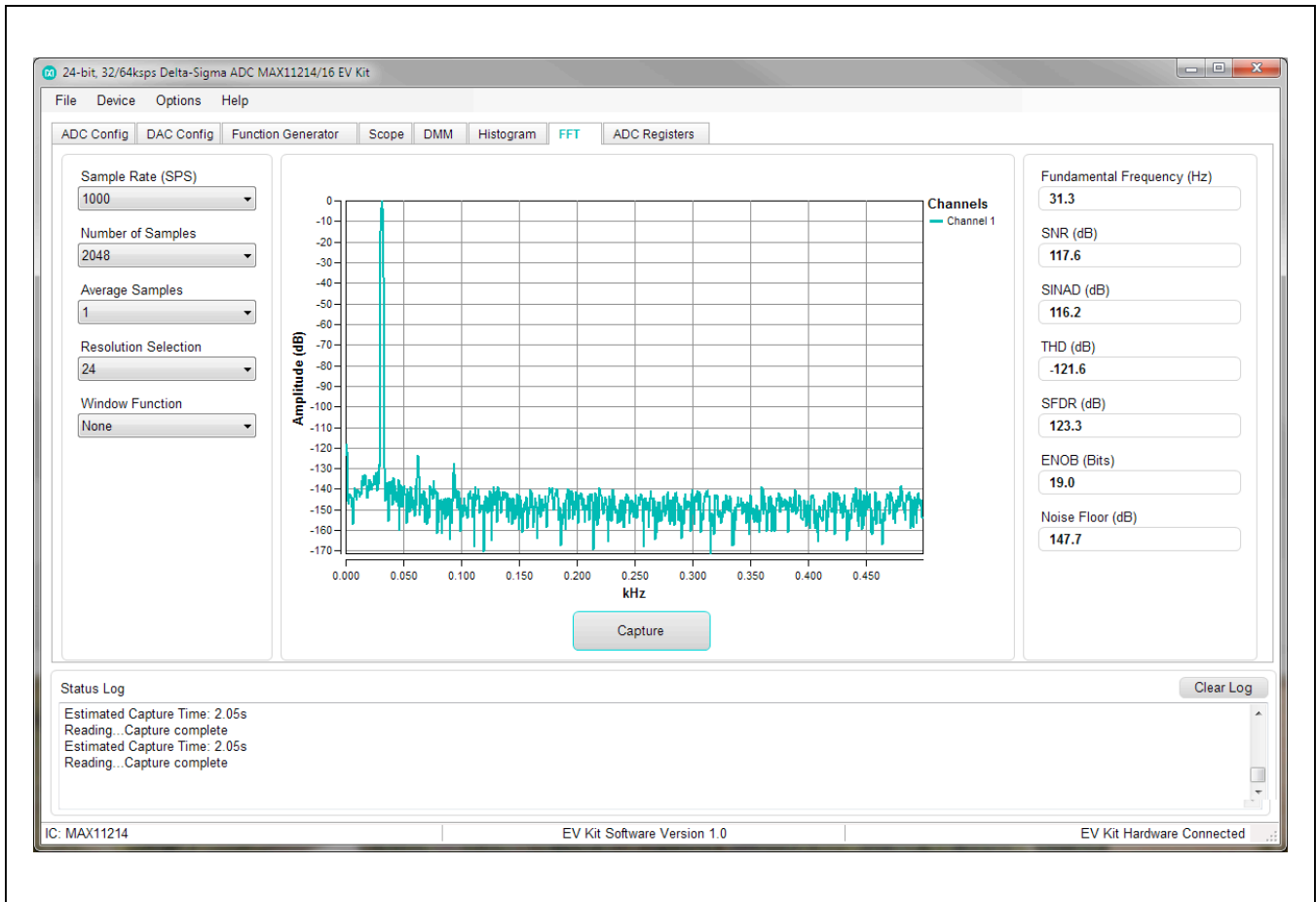

Figure 7. MAX1121X EV Kit Software (FFT Tab)

ADC Registers Tab

The **ADC Registers** tab sheet shows the ADC registers on the left. The middle section shows the bits and bit descriptions of the selected register. Click **Read All** to read all registers and refresh the window with the register settings. To write a register first, select the hex value in the Value (Hex) column, type the desired hex value and press **Enter**.

The **Command Byte** is on the right side of the tab sheet. This byte precedes all SPI transactions and is described in the ADC data sheet. To send a command byte, enter a hex value in the Numeric box and click the **Send** button. The command byte has two different formats including Conversion Mode and Register Access Mode. Select the radio button for the desired mode to see the bit description in the table.

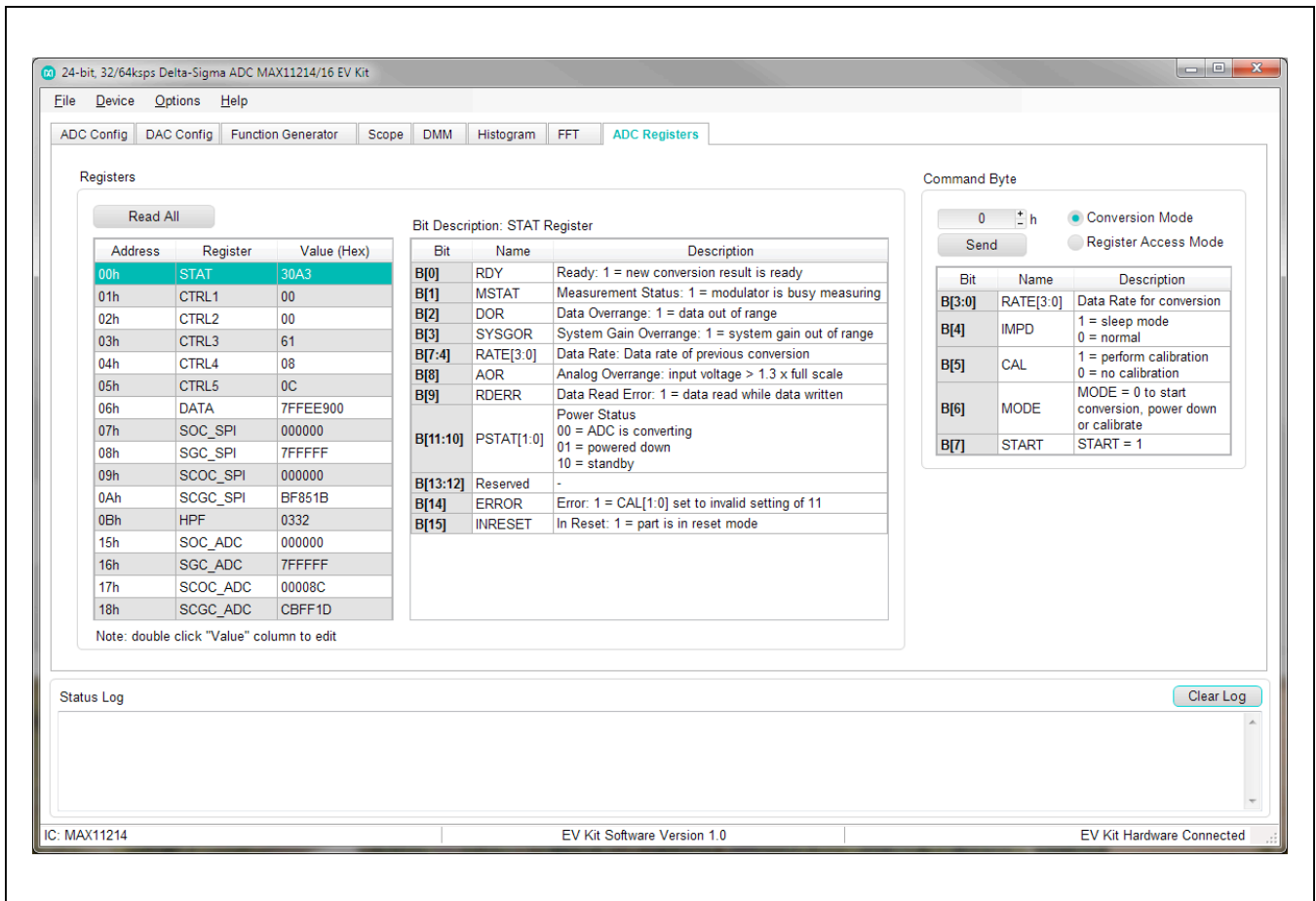

Figure 8. MAX1121X EV Kit Software (ADC Registers Tab)

Detailed Description of Hardware

This EV kit provides a proven layout to demonstrate the performance of the MAX1121X 24-bit delta-sigma ADC. Included in the EV kit are digital isolators (MAX14934), ultra-low-noise LDOs (MAX8842) to all supply pins of the IC, an on-board reference (MAX6126), a precision amplifier (MAX44241) for the analog inputs, 16-bit DAC (MAX542) with precision amplifiers (MAX9632), and sync-in and sync-out signals for coherent sampling.

An on-board controller is provided to allow for evaluation in standalone mode, which has limitations on maximum sample size and it cannot perform coherent sampling. The EV kit can be used with FPGA mode to achieve larger sample depth and coherent sampling.

The ADC has several input options which are selected by J26 and J27. The external option allows for wires attached to the screw terminals at J10. The amplifier option allows for signals at testpoints CH_A to CH_D. The DAC option allows for inputs to be driven from an on-board DAC. The REF options connect the inputs to the voltage reference of the ADC.

User-Supplied SPI

To evaluate the ADC on this EV kit with a user-supplied SPI bus, disconnect from the FMC bus and remove jumper J20. Apply the user-supplied SPI signals to SCLK, CSB, DIN, and DOUT at the PMOD_A header (J32). Make sure the return ground is connected to PMOD ground. To communicate to the on-board DAC connect the user-supplied SPI signals to CSB, SCLK, DIN, and LDAC at the PMOD_B header (J33). Make sure the return ground is connected to PMOD ground.

The on-board FTDI chip used for standalone mode does not conflict with the user-supplied SPI if it is powered off by removing jumper J20.

Caution: Do not plug this header into a standard PMOD interface found on other FPGA or microcontroller products. The signal definition is unique to this EV kit.

User-Supplied Reference

For user-supplied reference voltage, set jumpers at J21 and J23 to positions 2-3 and apply external reference to either J9 or to the EXT_REFN and EXT_REFP testpoints.

User-Supplied AVSS

The AVSS supply is set to GND or -1.8V by Jumper J5. For user-supplied AVSS, remove the jumper from J5 and apply AVSS to the screw-terminals/testpoint at J13. Make sure that this external supply has the correct relation to system ground.

User-Supplied AVDD

The AVDD supply is set to 3.6V or 1.8V by jumper J8. For user-supplied AVDD, remove the jumper from J8 and apply AVDD to the screw-terminals/testpoint at J13. Make sure that this external supply has the correct relation to system ground.

Bipolar Powered vs. Unipolar Powered

The ADC supports both unipolar and bipolar ranges. For unipolar mode, jumper J8 pins 2-3 to power AVDD with 3.6V and jumper J5 pins 1-2 to set AVSS to GND. For bipolar mode, jumper J8 pins 1-2 to power AVDD with 1.8V and jumper J5 pins 2-3 to set AVSS to -1.8V.

External Clock

When the ADC is configured to use an external clock, Jumper J36 pins 2-3 to select the on-board oscillator as the clock source. Jumper J36 pins 1-2 to select the SMA connector (and user-provided clock) as the clock source.

GPIO

Testpoints are provided for the three GPIO signals from the ADC, GPIO1, GPIO2, and GPIO3. The **ADC Config** tab can configure these as input/output and read/drive the GPIO pins. GPIO1 connects to a FET which allows J14.1 and TP2 to be connected to ground by driving GPIO1 high (note that DVDD should be to 3.3V to drive the FET).

ADC Input Amplifiers

The input amplifiers allow for significant flexibility. The amplifier input stage begins with testpoints labeled CH_A to CH_D. Each set of testpoints has options to ground either the inverting or noninverting inputs. The jumper block J29 and J25 allow for bypassing the first stage of amplifiers, or connecting the first stage to the second stage. Jumper J7 can provide an offset of 2.5V to the CH_A/CH_B signals – leave unpopulated to have an offset of 0V. Similarly, jumper J6 can provide an offset of 2.5V to the CH_C/CH_D signals – leave unpopulated to have an offset of 0V.

DAC and DAC Amplifiers

In [Figure 2](#), the GUI shows a functional diagram of the DAC and DAC amplifiers. Here jumper J45 can be connected to 2.5V to add a 2.5V offset to the DAC_OUT+ signal, and J44 can be connected to 2.5V to add 2.5V to the DAC_OUT- signal.

The value at **DAC_OUT+** and **DAC_OUT-** are available to drive to the ADC by use of jumpers J26 and J27.

Also, please note that the **DAC_OUT+** and **DAC_OUT-** values shown by the GUI are only valid if the settings at J44 and J45 are the same on both the PCB and the GUI.

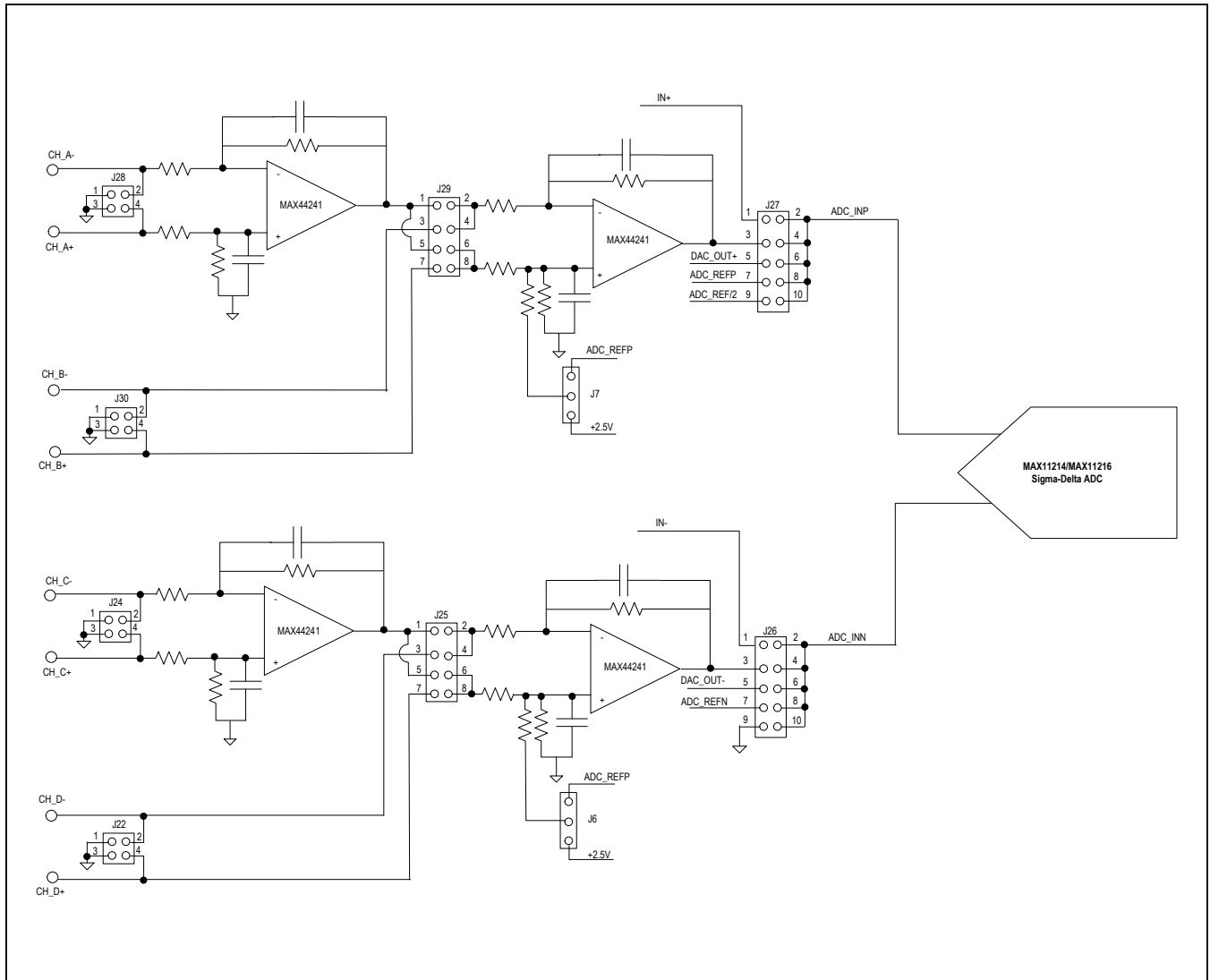

Figure 9. Analog Front-End

Table 4. Analog Input Configurations (Ch A - D)

CONFIGURATION		SIGNAL-PATH INPUT CONFIGURATION	INPUT CONNECTORS	JUMPER POSITIONS
No.	DESCRIPTION			
1	Channel A and C	Noninverting, differential, second-order LPF (default)	CH_A- and CH_C-	J28: 3-4 J30: 3-4 J24: 3-4 J22: 3-4 J29: 1-2 and 7-8 J25: 1-2 and 7-8 J26: 3-4 J27: 3-4 J7: 1-2 (for bipolar signal) or Open for unipolar signal J8: 1-2 (for bipolar signal) or Open for unipolar signal
2	Channel A and C	Inverting, differential, second-order LPF	CH_A+ and CH_C+	J28: 1-2 J30: 3-4 J24: 1-2 J22: 3-4 J29: 1-2 and 7-8 J25: 1-2 and 7-8 J26: 3-4 J27: 3-4 J7: 1-2 (for bipolar signal) or Open for unipolar signal J8: 1-2 (for bipolar signal) or OPEN for unipolar signal
3	Channel B and D	Noninverting, differential, first-order LPF	CH_B+ and CH_D+	J28: 1-2 and 3-4 J30: 1-2 J24: 1-2 and 3-4 J22: 1-2 J29: 3-4 and 7-8 J25: 3-4 and 7-8 J26: 3-4 J27: 3-4 J7: 1-2 (for bipolar signal) or Open for unipolar signal J8: 1-2 (for bipolar signal) or Open for unipolar signal
4	Channel B and D	Inverting, differential, first-order LPF	CH_B- and CH_D-	J28: 1-2 and 3-4 J30: 3-4 J24: 1-2 and 3-4 J22: 3-4 J29: 3-4 and 7-8 J25: 3-4 and 7-8 J26: 3-4 J27: 3-4 J7: 1-2 (for bipolar signal) or Open for unipolar signal J8: 1-2 (for bipolar signal) or Open for unipolar signal

Table 4. Analog Input Configurations (Ch A - D) (continued)

CONFIGURATION		SIGNAL-PATH INPUT CONFIGURATION	INPUT CONNECTORS	JUMPER POSITIONS
No.	DESCRIPTION			
5	External Inputs	User-supplied signals	IN+ and IN-	J28: 1-2 and 3-4 J30: 1-2 and 3-4 J24: 1-2 and 3-4 J22: 1-2 and 3-4 J29: 3-4 and 7-8 J25: 3-4 and 7-8 J26: 1-2 J27: 1-2 J7: Open J8: Open
6	DAC Output	DAC output buffered with MAX9632	DAC_OUT+ and DAC_OUT-	J28: 1-2 and 3-4 J30: 1-2 and 3-4 J24: 1-2 and 3-4 J22: 1-2 and 3-4 J29: 3-4 and 7-8 J25: 3-4 and 7-8 J26: 5-6 J27: 5-6 J7: Open J8: Open
7	ADC Voltage Reference	Voltage reference input to ADC from MAX6126 or external source (see J21 and J23)	ADC_REFP and ADC_REFN	J28: 1-2 and 3-4 J30: 1-2 and 3-4 J24: 1-2 and 3-4 J22: 1-2 and 3-4 J29: 3-4 and 7-8 J25: 3-4 and 7-8 J26: 7-8 J27: 7-8 J7: Open J8: Open

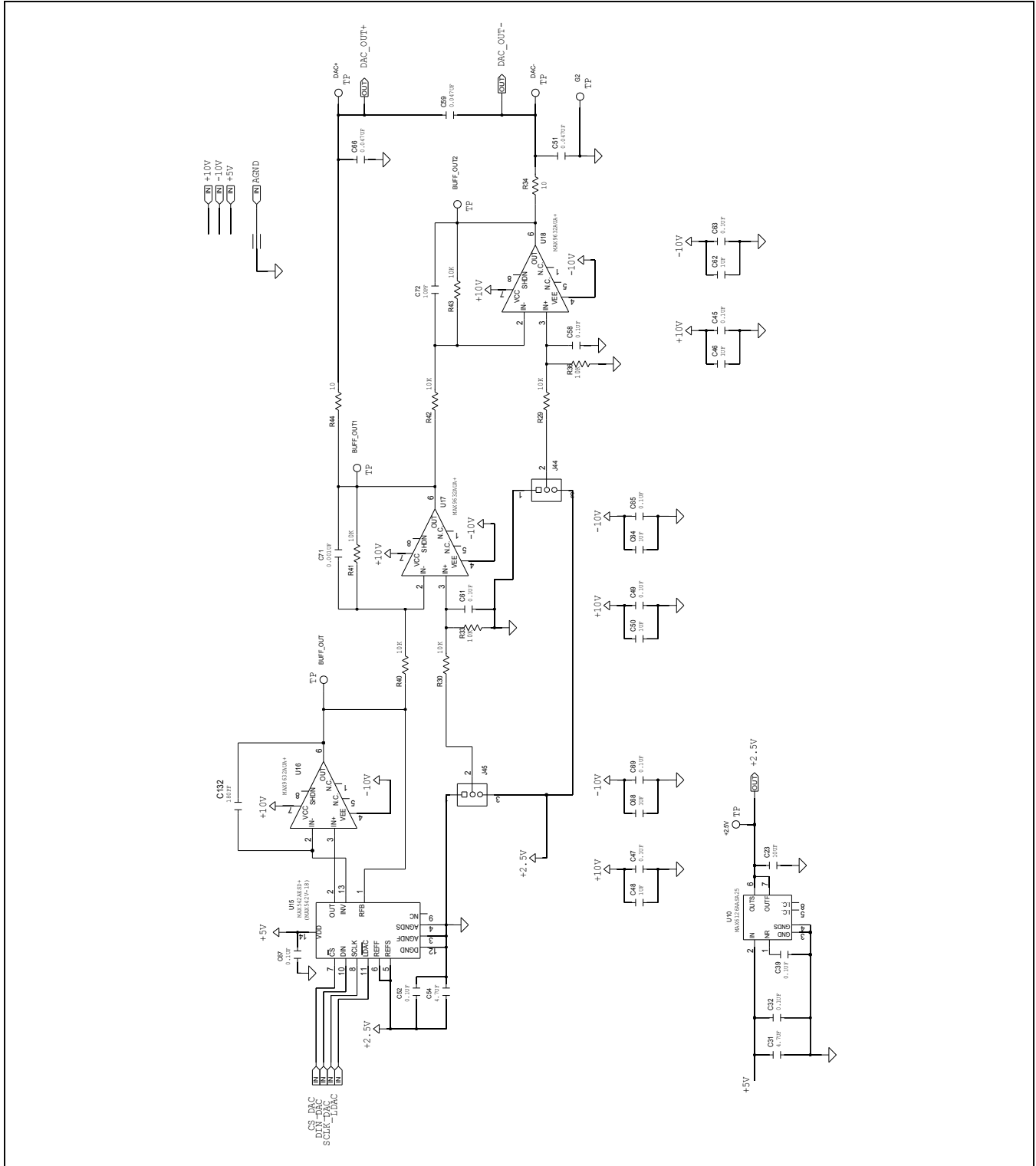

Figure 10b. MAX1121X EV Kit Schematic (Sheet 2 of 6)

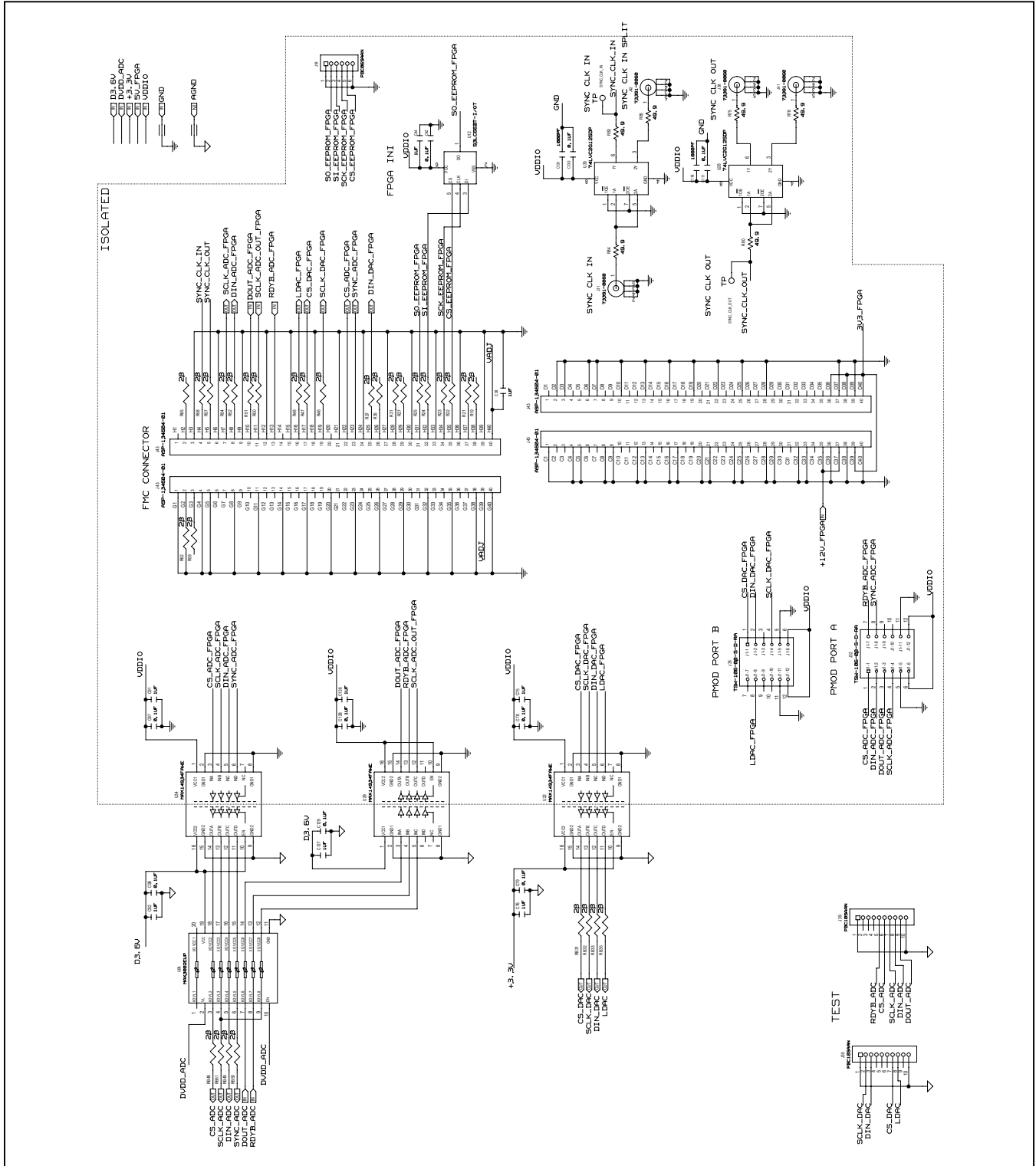

Figure 10d. MAX1121X EV Kit Schematic (Sheet 4 of 6)

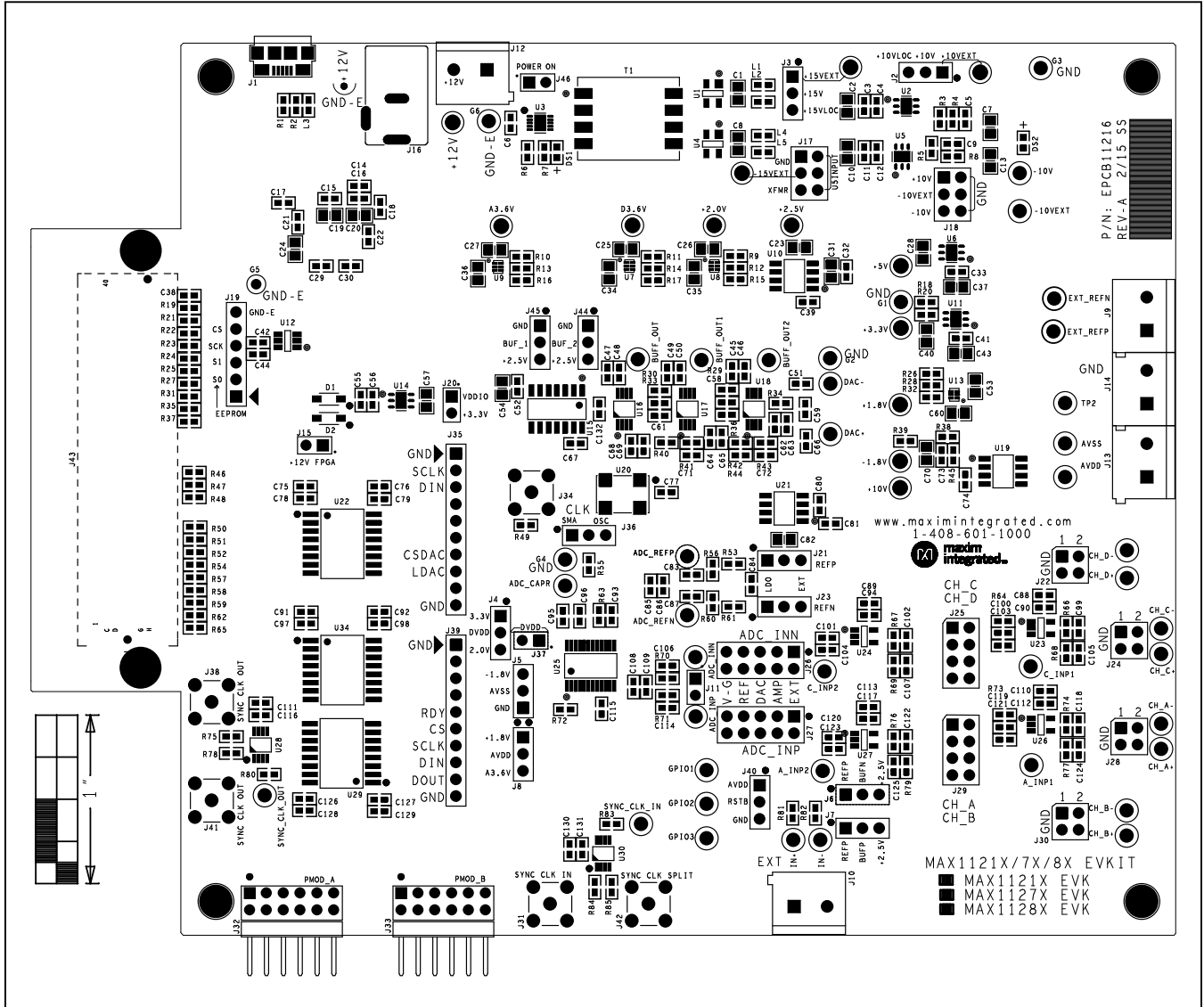

Figure 11. MAX1121X EV Kit Component Placement Guide—Top Side

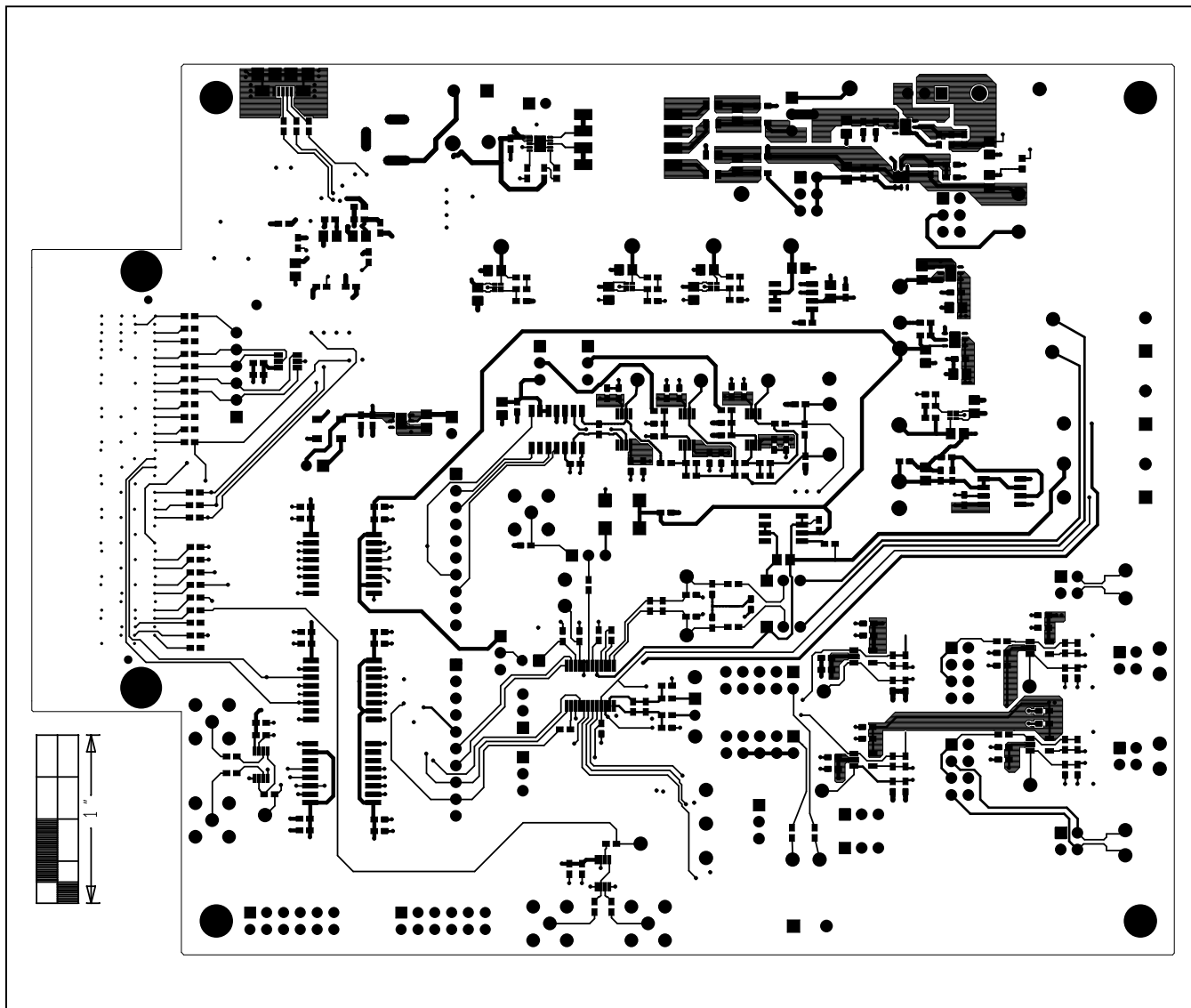

Figure 12. MAX1121X EV Kit PCB Layout—Layer 1

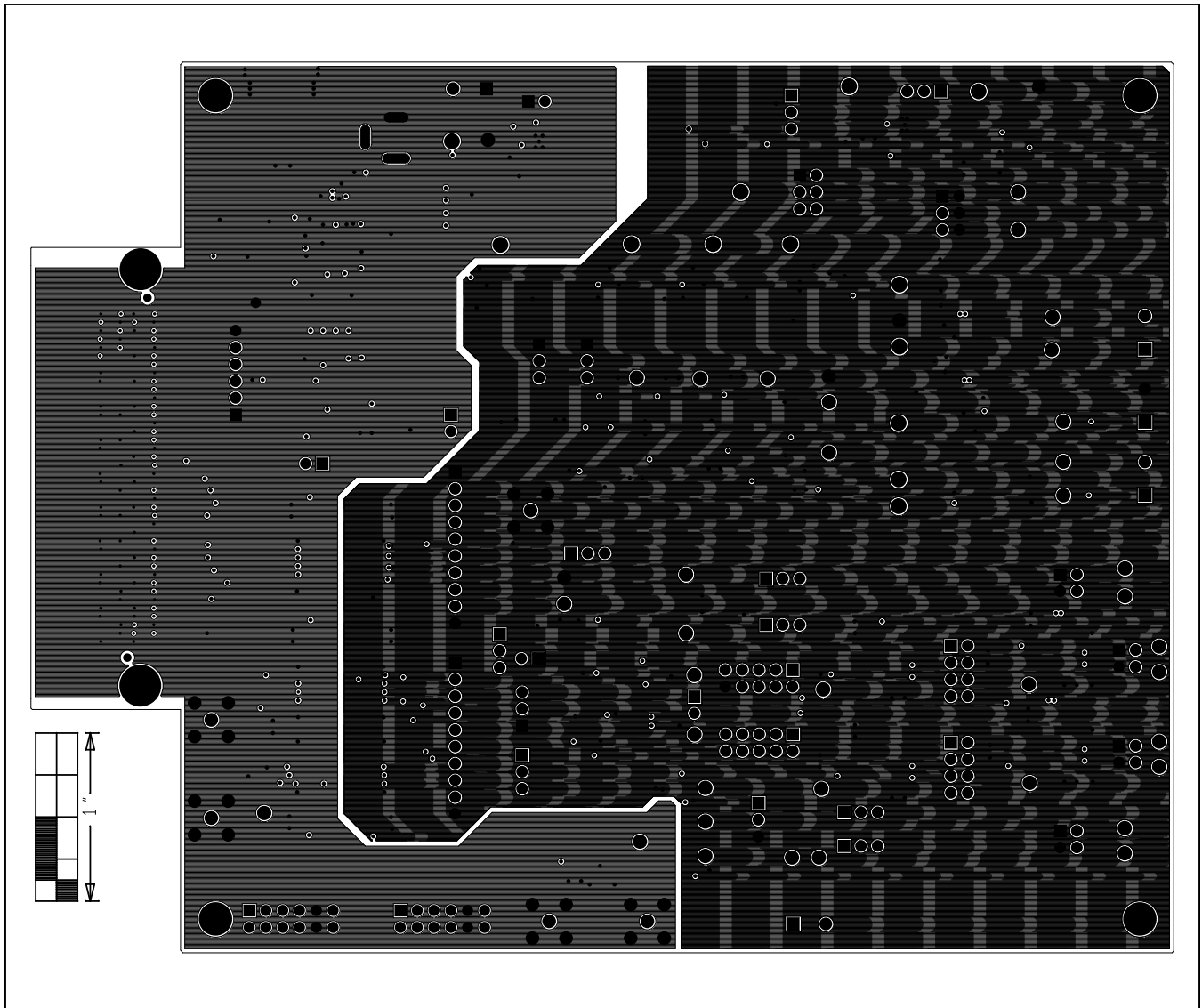

Figure 13. MAX1121X EV Kit PCB Layout—Layer 2

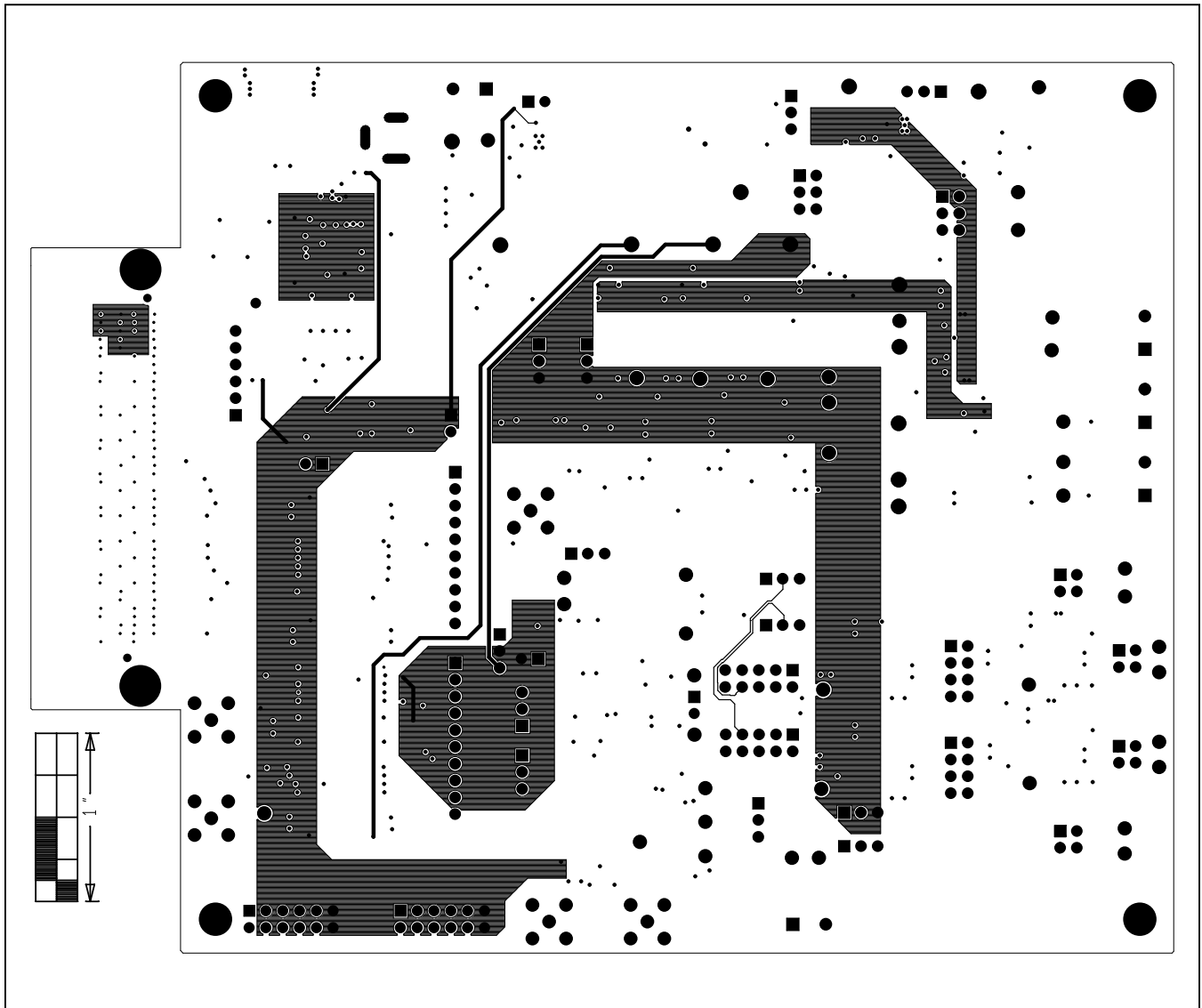

Figure 14. MAX1121X EV Kit PCB Layout—Layer 3

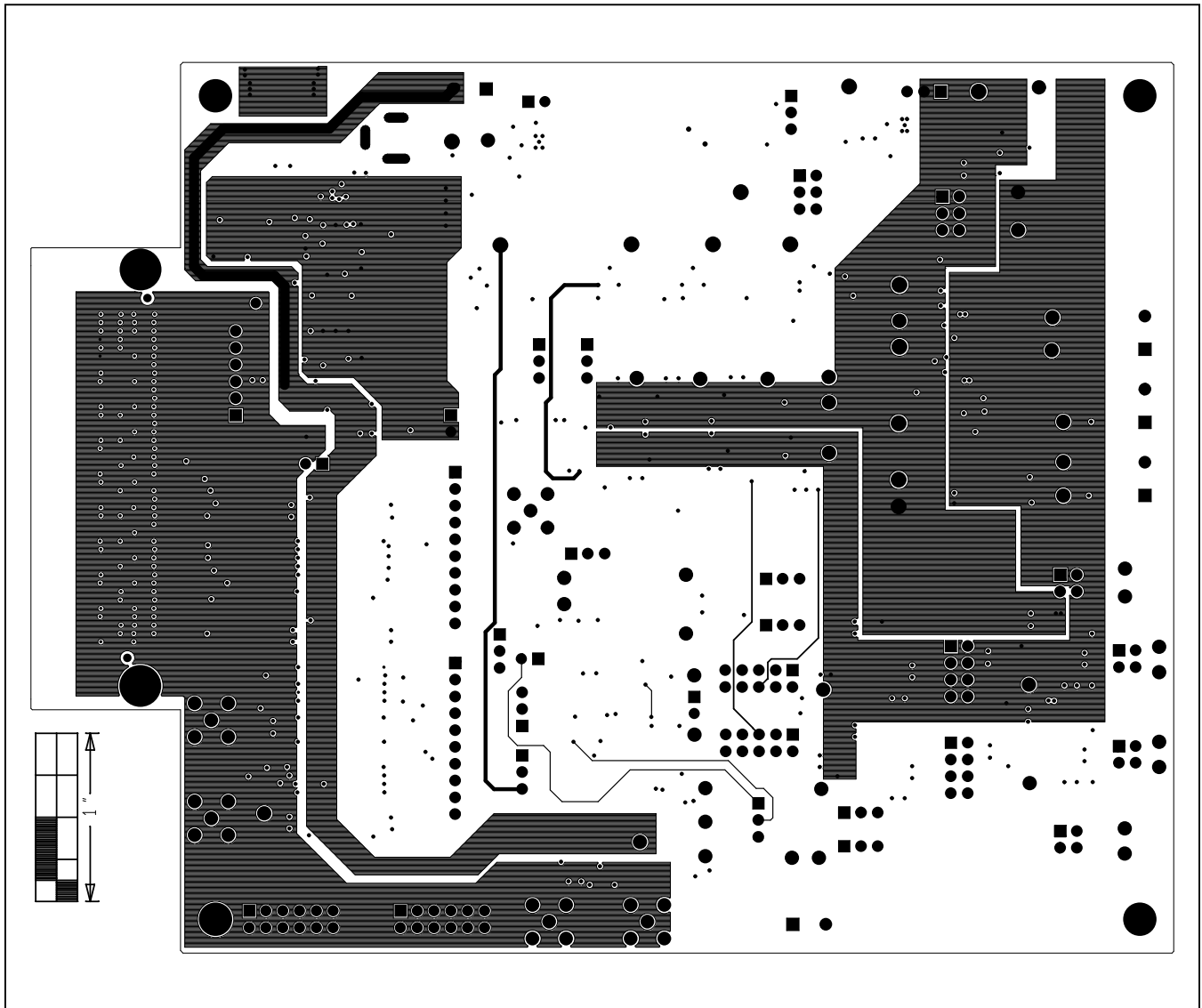

Figure 15. MAX1121X EV Kit PCB Layout—Layer 4

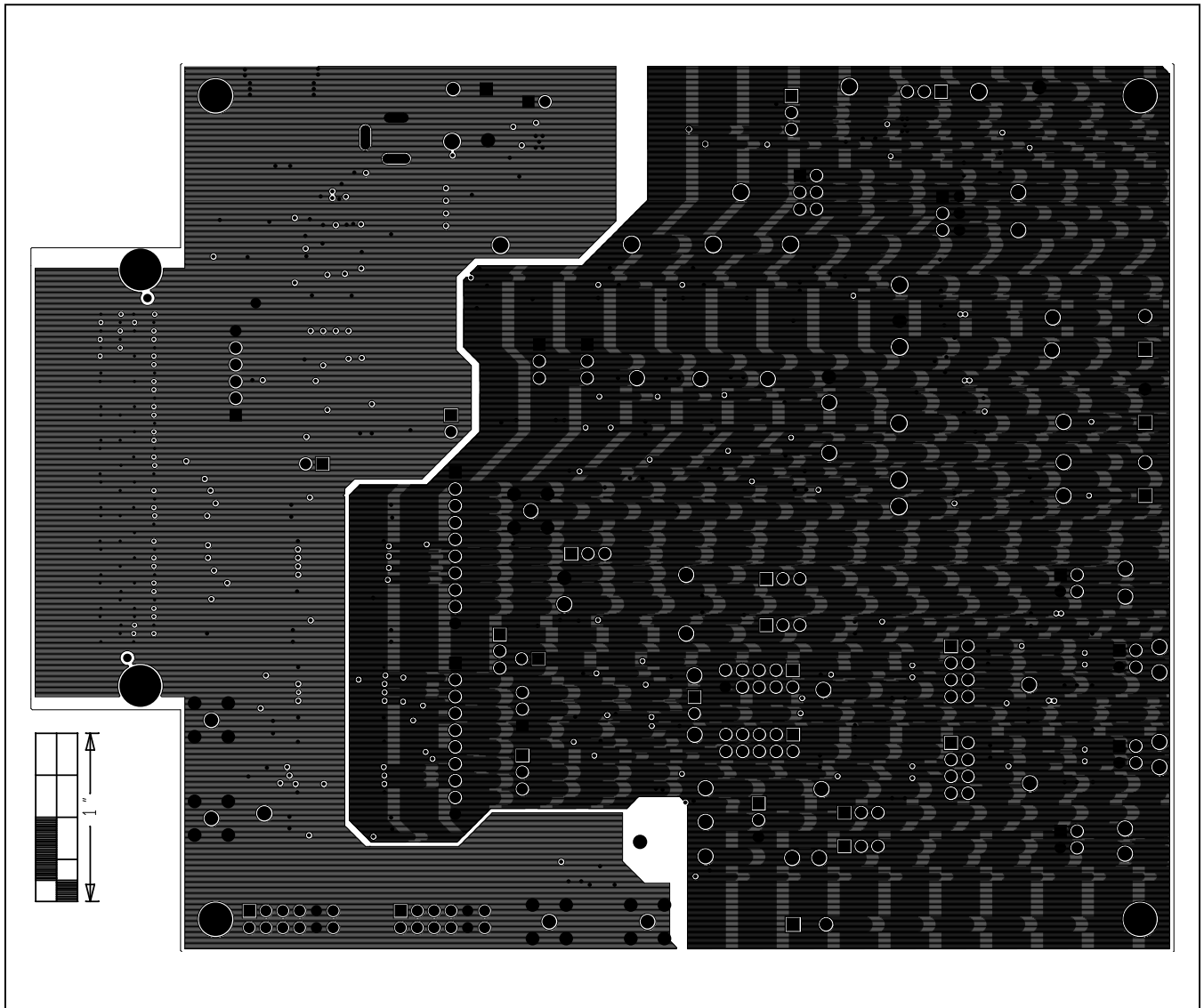

Figure 16. MAX1121X EV Kit PCB Layout—Layer 5

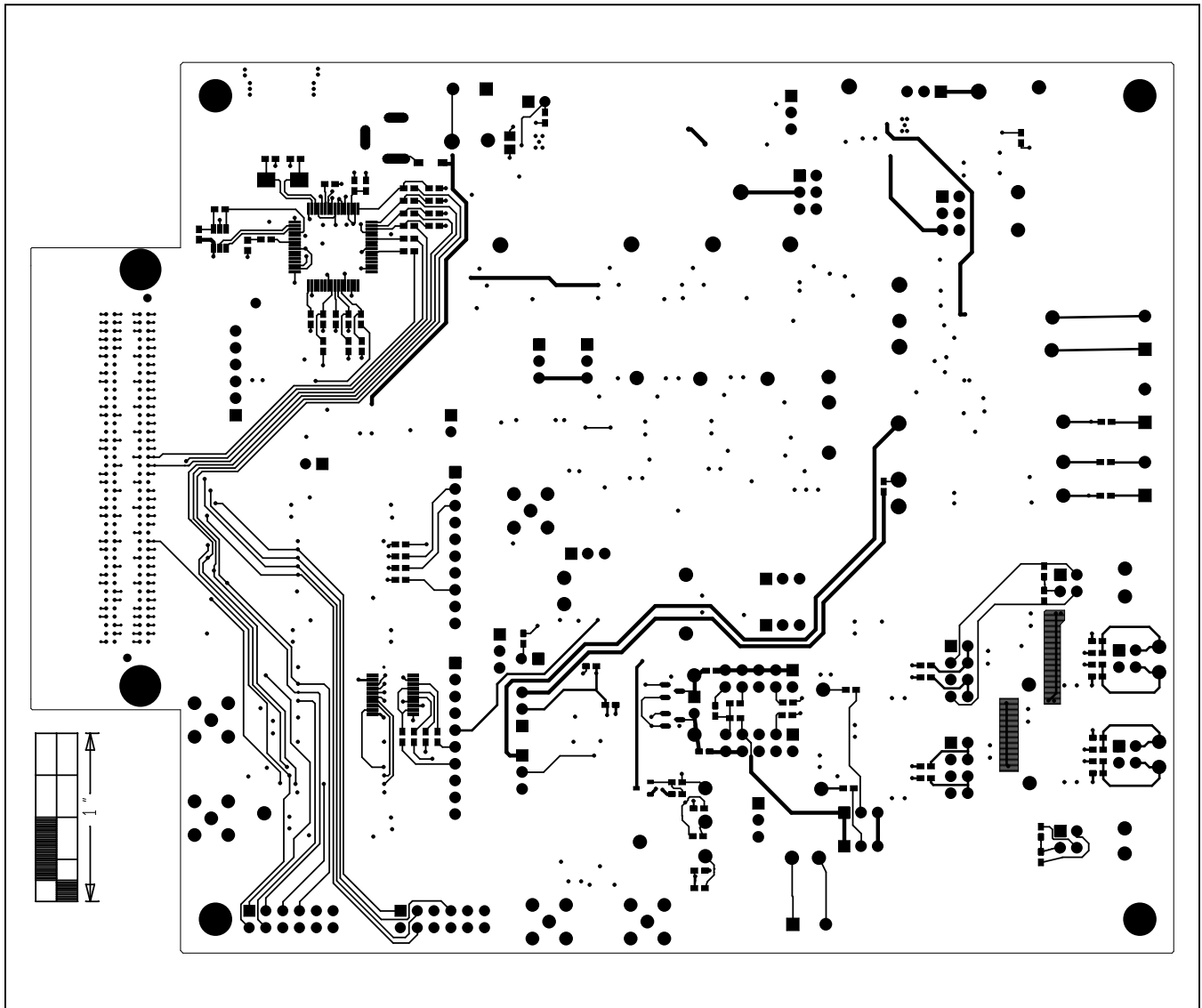

Figure 17. MAX1121X EV Kit PCB Layout—Layer 6

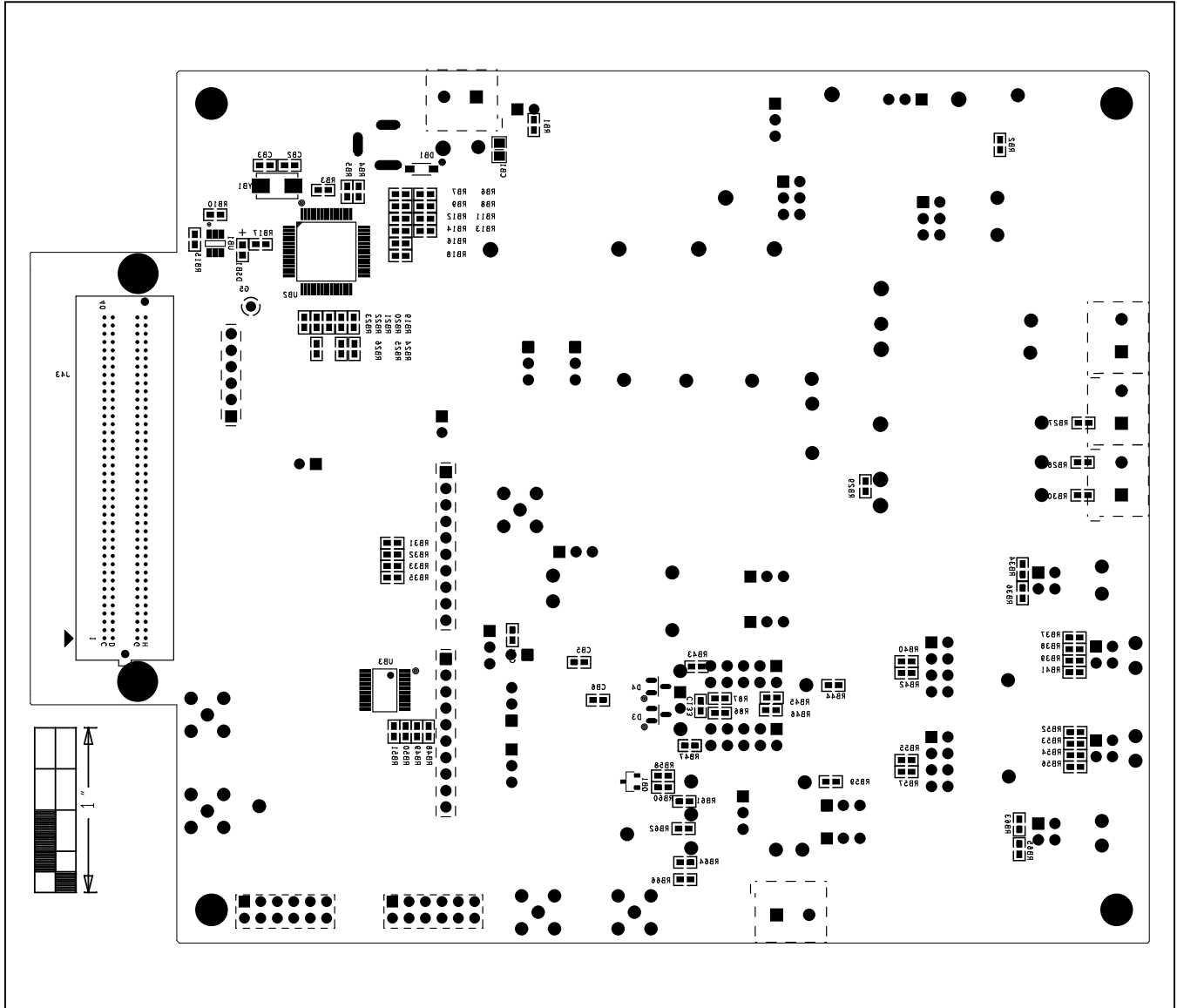

Figure 18. MAX1121X EV Kit Component Placement Guide—Bottom Side

Component List

Refer to file “evkit_bom_max1121X_evkit_a.csv” attached to this data sheet for component information.

Ordering Information

PART	TYPE
MAX11214EVKIT#	EVKIT
MAX11216EVKIT#	EVKIT

#Denotes RoHS compliant.