



Click [here](#) to ask an associate for production status of specific part numbers.

Two-Channel, Low-Power, 3kV_{RMS} and 5kV_{RMS} Digital Isolators

MAX12930/MAX12931

General Description

The MAX12930/MAX12931 are a family of 2-channel, 3kV/5kV_{RMS} digital galvanic isolators using Maxim's proprietary process technology. These devices transfer digital signals between circuits with different power domains while using as little as 0.65mW per channel at 2Mbps with 1.8V.

The two channels of the MAX12931 transfer data in opposite directions, and this makes the MAX12931 ideal for isolating the TX and RX lines of a transceiver. The MAX12930 features two channels transferring data in the same direction.

Both devices are available with a maximum data rate of either 25Mbps or 150Mbps and with the default outputs that are either high or low. The default is the state the output assumes when the input is not powered, or if the input is open-circuit. See the [Ordering Information](#) and [Product Selector Guide](#) for suffixes associated with each option. Independent 1.71V to 5.5V supplies on each side of the isolator also make the devices suitable for use as level translators.

The MAX12930/MAX12931 are available in an 8-pin, narrow-body SOIC package. In addition, the MAX12931 is available in a 16-pin, wide-body SOIC package. The package material of the 8-pin narrow-body SOIC package has a minimum comparative tracking index (CTI) of 400, which gives it a group II rating in creepage tables. The package material of the 16-pin wide-body SOIC package has a CTI of 600, which gives it a group I rating in creepage tables. All devices are rated for operation at ambient temperatures of -40°C to +125°C.

Benefits and Features

- Robust Galvanic Isolation of Digital Signals
 - Withstands 5kV_{RMS} for 60s (V_{ISO}) Wide-Body
 - Withstands 3kV_{RMS} for 60s (V_{ISO}) Narrow-Body
 - Continuously Withstands 848V_{RMS} (V_{IOWM}) Wide-Body
 - Continuously Withstands 445V_{RMS} (V_{IOWM}) Narrow-Body
 - Withstands ±10kV Surge Between GNDA and GNDB with 1.2/50µs Waveform
 - High CMTI (50kV/µs, typ)
- Options to Support a Broad Range of Applications
 - 2 Data Rates (25Mbps/150Mbps)
 - 2 Channel Direction Configurations
 - 2 Output Default States (High or Low)
- Low Power Consumption
 - 1.3mW per Channel at 2Mbps with V_{DD} = 3.3V
 - 3.3mW per Channel at 100Mbps with V_{DD} = 1.8V

Safety Regulatory Approvals

(see [Safety Regulatory Approvals](#))

- UL According to UL1577
- cUL According to CSA Bulletin 5A
- VDE 0884-11 Basic Insulation (Narrow SOIC)

Applications

- Fieldbus Communications for Industrial Automation
- Isolated RS232, RS-485/RS-422, CAN
- General Isolation Application
- Battery Management
- Medical Systems

[Ordering Information](#) and [Product Selector Guide](#) appear at end of data sheet.

Functional Diagrams

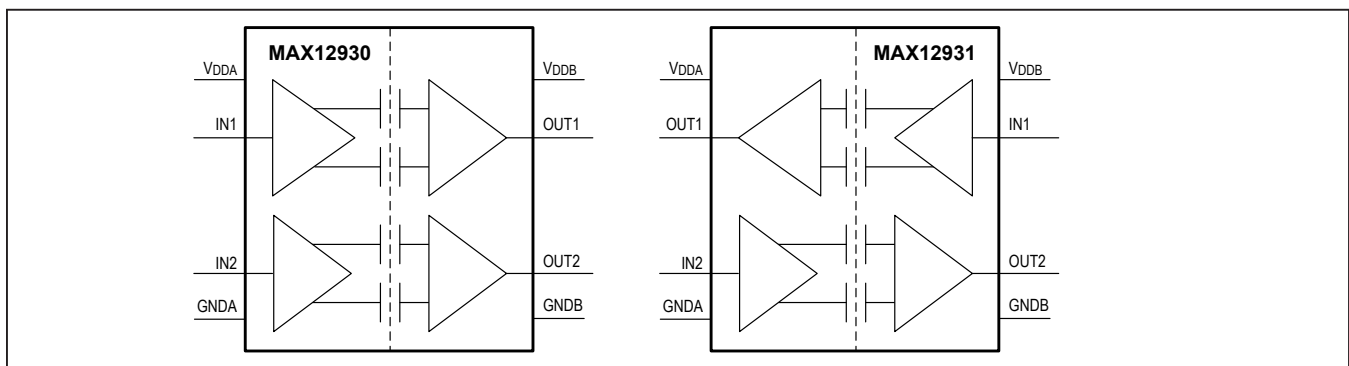

19-8563; Rev 10; 8/21

Absolute Maximum Ratings

| | | |
|-------------------------------|----------------------------------|---|
| V _{DDA} to GNDA..... | -0.3V to +6V | Continuous Power Dissipation (T _A = +70°C) Wide SOIC (derate 14.1mW/°C above +70°C) 1126.8mW Narrow SOIC (derate 5.79mW/°C above +70°C)...462.96mW |
| V _{DDB} to GNDB..... | -0.3V to +6V | |
| IN_ on Side A to GNDA..... | -0.3V to +6V | Operating Temperature Range..... -40°C to +125°C Maximum Junction Temperature +150°C Storage Temperature Range..... -60°C to +150°C Soldering Temperature (reflow)..... +260°C |
| IN_ on Side B to GNDB..... | -0.3V to +6V | |
| OUT_ on Side A to GNDA..... | -0.3V to V _{DDA} + 0.3V | Short-Circuit Duration OUT_ on Side A to GNDA, OUT_ on Side B to GNDB..... Continuous |
| OUT_ on Side B to GNDB..... | -0.3V to V _{DDB} + 0.3V | |

Stresses beyond those listed under "Absolute Maximum Ratings" may cause permanent damage to the device. These are stress ratings only, and functional operation of the device at these or any other conditions beyond those indicated in the operational sections of the specifications is not implied. Exposure to absolute maximum rating conditions for extended periods may affect device reliability.

Package Information

| | |
|---|-------------------------|
| PACKAGE TYPE: 8 NARROW SOIC | |
| Package Code | S8MS-22 |
| Outline Number | 21-0041 |
| Land Pattern Number | 90-0096 |
| THERMAL RESISTANCE, FOUR-LAYER BOARD | |
| Junction to Ambient (θ _{JA}) | 172.8°C/W |
| Junction to Case (θ _{JC}) | 67.6°C/W |

| | |
|---|-------------------------|
| PACKAGE TYPE: 16 WIDE SOIC | |
| Package Code | W16MS-11 |
| Outline Number | 21-0042 |
| Land Pattern Number | 90-0107 |
| THERMAL RESISTANCE, FOUR-LAYER BOARD | |
| Junction to Ambient (θ _{JA}) | 71°C/W |
| Junction to Case (θ _{JC}) | 23°C/W |

For the latest package outline information and land patterns (footprints), go to www.maximintegrated.com/packages. Note that a "+", "#", or "-" in the package code indicates RoHS status only. Package drawings may show a different suffix character, but the drawing pertains to the package regardless of RoHS status.

Package thermal resistances were obtained using the method described in JEDEC specification JESD51-7, using a four-layer board. For detailed information on package thermal considerations, refer to www.maximintegrated.com/thermal-tutorial.

DC Electrical Characteristics

(V_{DDA} - V_{GNDA} = 1.71V to 5.5V, V_{DDB} - V_{GNDB} = 1.71V to 5.5V, C_L = 15pF, T_A = -40°C to +125°C, unless otherwise noted. Typical values are at V_{DDA} - V_{GNDA} = 3.3V, V_{DDB} - V_{GNDB} = 3.3V, GNDA = GNDB, T_A = 25°C, unless otherwise noted.) (Note 1)

| PARAMETER | SYMBOL | CONDITIONS | MIN | TYP | MAX | UNITS |
|---|------------------------|---|-------------------------|------|------|-------|
| POWER SUPPLY | | | | | | |
| Supply Voltage | V _{DDA} | Relative to GNDA | 1.71 | | 5.5 | V |
| | V _{DDB} | Relative to GNDB | 1.71 | | 5.5 | |
| Undervoltage-Lockout Threshold | V _{UVLO_} | V _{DD_} rising | 1.5 | 1.6 | 1.66 | V |
| Undervoltage-Lockout Threshold Hysteresis | V _{UVLO_HYST} | | | 45 | | mV |
| Supply Current (MAX12930_) (Note 2) | I _{DDA} | 1MHz square wave, C _L = 0pF | V _{DDA} = 5V | 0.32 | 0.58 | mA |
| | | | V _{DDA} = 3.3V | 0.31 | 0.54 | |
| | | | V _{DDA} = 2.5V | 0.3 | 0.53 | |
| | | | V _{DDA} = 1.8V | 0.29 | 0.39 | |
| | | 12.5MHz square wave, C _L = 0pF | V _{DDA} = 5V | 0.81 | 1.26 | |
| | | | V _{DDA} = 3.3V | 0.8 | 1.20 | |
| | | | V _{DDA} = 2.5V | 0.78 | 1.18 | |
| | | | V _{DDA} = 1.8V | 0.77 | 1.01 | |
| | | 50MHz square wave, C _L = 0pF | V _{DDA} = 5V | 2.15 | 3.00 | |
| | | | V _{DDA} = 3.3V | 2.09 | 2.91 | |
| | | | V _{DDA} = 2.5V | 2.06 | 2.88 | |
| | | | V _{DDA} = 1.8V | 2 | 2.62 | |
| | I _{DDB} | 1MHz square wave, C _L = 0pF | V _{DDB} = 5V | 0.5 | 0.83 | mA |
| | | | V _{DDB} = 3.3V | 0.47 | 0.79 | |
| | | | V _{DDB} = 2.5V | 0.45 | 0.76 | |
| | | | V _{DDB} = 1.8V | 0.4 | 0.67 | |
| | | 12.5MHz square wave, C _L = 0pF | V _{DDB} = 5V | 1.37 | 1.83 | |
| | | | V _{DDB} = 3.3V | 1.02 | 1.40 | |
| | | | V _{DDB} = 2.5V | 0.87 | 1.22 | |
| | | | V _{DDB} = 1.8V | 0.71 | 1.00 | |
| | | 50MHz square wave, C _L = 0pF | V _{DDB} = 5V | 4.21 | 4.99 | |
| | | | V _{DDB} = 3.3V | 2.81 | 3.39 | |
| | | | V _{DDB} = 2.5V | 2.21 | 2.69 | |
| | | | V _{DDB} = 1.8V | 1.69 | 2.04 | |

DC Electrical Characteristics (continued)

(V_{DDA} - V_{GNDA} = 1.71V to 5.5V, V_{DDB} - V_{GNDB} = 1.71V to 5.5V, C_L = 15pF, T_A = -40°C to +125°C, unless otherwise noted. Typical values are at V_{DDA} - V_{GNDA} = 3.3V, V_{DDB} - V_{GNDB} = 3.3V, G_{NDA} = G_{NDB}, T_A = 25°C, unless otherwise noted.) (Note 1)

| PARAMETER | SYMBOL | CONDITIONS | MIN | TYP | MAX | UNITS |
|-------------------------------------|------------------|---|-------------------------|------|------|-------|
| Supply Current (MAX12931_) (Note 2) | I _{DDA} | 1MHz square wave, C _L = 0pF | V _{DDA} = 5V | 0.42 | 0.70 | mA |
| | | | V _{DDA} = 3.3V | 0.39 | 0.67 | |
| | | | V _{DDA} = 2.5V | 0.38 | 0.64 | |
| | | | V _{DDA} = 1.8V | 0.36 | 0.56 | |
| | | 12.5MHz square wave, C _L = 0pF | V _{DDA} = 5V | 1.07 | 1.52 | |
| | | | V _{DDA} = 3.3V | 0.89 | 1.29 | |
| | | | V _{DDA} = 2.5V | 0.81 | 1.19 | |
| | | | V _{DDA} = 1.8V | 0.73 | 1.03 | |
| | | 50MHz square wave, C _L = 0pF | V _{DDA} = 5V | 3.06 | 3.87 | |
| | | | V _{DDA} = 3.3V | 2.37 | 3.06 | |
| | | | V _{DDA} = 2.5V | 2.08 | 2.72 | |
| | | | V _{DDA} = 1.8V | 1.82 | 2.33 | |
| | I _{DDB} | 1MHz square wave, C _L = 0pF | V _{DDB} = 5V | 0.42 | 0.70 | |
| | | | V _{DDB} = 3.3V | 0.39 | 0.67 | |
| | | | V _{DDB} = 2.5V | 0.38 | 0.64 | |
| | | | V _{DDB} = 1.8V | 0.36 | 0.56 | |
| | | 12.5MHz square wave, C _L = 0pF | V _{DDB} = 5V | 1.07 | 1.52 | |
| | | | V _{DDB} = 3.3V | 0.89 | 1.29 | |
| | | | V _{DDB} = 2.5V | 0.81 | 1.19 | |
| | | | V _{DDB} = 1.8V | 0.73 | 1.03 | |
| | | 50MHz square wave, C _L = 0pF | V _{DDB} = 5V | 3.06 | 3.87 | |
| | | | V _{DDB} = 3.3V | 2.37 | 3.06 | |
| | | | V _{DDB} = 2.5V | 2.08 | 2.72 | |
| | | | V _{DDB} = 1.8V | 1.82 | 2.33 | |
| LOGIC INPUTS AND OUTPUTS | | | | | | |
| Input High Voltage | V _{IH} | 2.25V ≤ V _{DD_} ≤ 5.5V | 0.7 x V _{DD_} | | | V |
| | | 1.71V ≤ V _{DD_} < 2.25V | 0.75 x V _{DD_} | | | |
| Input Low Voltage | V _{IL} | 2.25V ≤ V _{DD_} ≤ 5.5V | 0.8 | | | V |
| | | 1.71V ≤ V _{DD_} < 2.25V | 0.7 | | | |
| Input Hysteresis | V _{HYS} | MAX1293_B/E | 410 | | | mV |
| | | MAX1293_C/F | 80 | | | |
| Input Pullup Current (Note 3) | I _{PU} | IN_, MAX1293_B/C | -10 | -5 | -1.5 | μA |
| Input Pulldown Current (Note 3) | I _{PD} | IN_, MAX1293_E/F | 1.5 | 5 | 10 | μA |
| Input Capacitance | C _{IN} | IN_, f _{SW} = 1MHz | 2 | | | pF |

DC Electrical Characteristics (continued)

(V_{DDA} - V_{GNDA} = 1.71V to 5.5V, V_{DDB} - V_{GNDB} = 1.71V to 5.5V, C_L = 15pF, T_A = -40°C to +125°C, unless otherwise noted. Typical values are at V_{DDA} - V_{GNDA} = 3.3V, V_{DDB} - V_{GNDB} = 3.3V, G_{NDA} = G_{NDB}, T_A = 25°C, unless otherwise noted.) (Note 1)

| PARAMETER | SYMBOL | CONDITIONS | MIN | TYP | MAX | UNITS |
|------------------------------|-----------------|-------------------------------|------------------------|-----|-----|-------|
| Output Voltage High (Note 3) | V _{OH} | I _{OUT} = 4mA source | V _{DD_} - 0.4 | | | V |
| Output Voltage Low (Note 3) | V _{OL} | I _{OUT} = 4mA sink | | | 0.4 | V |

Dynamic Characteristics MAX1293_B/E

(V_{DDA} - V_{GNDA} = 1.71V to 5.5V, V_{DDB} - V_{GNDB} = 1.71V to 5.5V, C_L = 15pF, T_A = -40°C to +125°C, unless otherwise noted. Typical values are at V_{DDA} - V_{GNDA} = 3.3V, V_{DDB} - V_{GNDB} = 3.3V, G_{NDA} = G_{NDB}, T_A = 25°C, unless otherwise noted.) (Notes 1, 2)

| PARAMETER | SYMBOL | CONDITIONS | MIN | TYP | MAX | UNITS | |
|--|--------------------|---|------|------|------|-------|------|
| Common-Mode Transient Immunity | CMTI | I _{N_} = GND_ or V _{DD_} (Note 4) | | 50 | | kV/μs | |
| Maximum Data Rate | DR _{MAX} | | 25 | | | Mbps | |
| Minimum Pulse Width | PW _{MIN} | | | | 40 | ns | |
| Glitch Rejection | | | 10 | 17 | 29 | ns | |
| Propagation Delay (Figure 1) | t _{PLH} | 4.5V ≤ V _{DD_} ≤ 5.5V | 17.4 | 23.9 | 32.5 | ns | |
| | | 3.0V ≤ V _{DD_} ≤ 3.6V | 17.6 | 24.4 | 33.7 | | |
| | | 2.25V ≤ V _{DD_} ≤ 2.75V | 18.3 | 25.8 | 36.7 | | |
| | | 1.71V ≤ V _{DD_} ≤ 1.89V | 20.7 | 29.6 | 43.5 | | |
| | t _{PHL} | 4.5V ≤ V _{DD_} ≤ 5.5V | 16.9 | 23.4 | 33.6 | | |
| | | 3.0V ≤ V _{DD_} ≤ 3.6V | 17.2 | 24.2 | 35.1 | | |
| | | 2.25V ≤ V _{DD_} ≤ 2.75V | 17.8 | 25.4 | 38.2 | | |
| | | 1.71V ≤ V _{DD_} ≤ 1.89V | 19.8 | 29.3 | 45.8 | | |
| Pulse Width Distortion | PWD | | 0.4 | 4 | ns | | |
| Propagation Delay Skew Part-to-Part (same channel) | t _{SPLH} | 4.5V ≤ V _{DD_} ≤ 5.5V | | | 15.1 | ns | |
| | | 3.0V ≤ V _{DD_} ≤ 3.6V | | | 15 | | |
| | | 2.25V ≤ V _{DD_} ≤ 2.75V | | | 15.4 | | |
| | | 1.71V ≤ V _{DD_} ≤ 1.89V | | | 20.5 | | |
| | t _{SPHL} | 4.5V ≤ V _{DD_} ≤ 5.5V | | | | | 13.9 |
| | | 3.0V ≤ V _{DD_} ≤ 3.6V | | | | | 14.2 |
| | | 2.25V ≤ V _{DD_} ≤ 2.75V | | | | | 16 |
| | | 1.71V ≤ V _{DD_} ≤ 1.89V | | | | | 21.8 |
| Propagation Delay Skew Chan- nel-to-Channel (Same Direction) (MAX12930 only) | t _{SCSLH} | | | | 2 | ns | |
| | t _{SCSHL} | | | | 2 | | |

Dynamic Characteristics MAX1293_B/E (continued)

(V_{DDA} - V_{GNDA} = 1.71V to 5.5V, V_{DDB} - V_{GNDB} = 1.71V to 5.5V, C_L = 15pF, T_A = -40°C to +125°C, unless otherwise noted. Typical values are at V_{DDA} - V_{GNDA} = 3.3V, V_{DDB} - V_{GNDB} = 3.3V, G_{NDA} = G_{NDB}, T_A = 25°C, unless otherwise noted.) (Notes 1, 2)

| PARAMETER | SYMBOL | CONDITIONS | MIN | TYP | MAX | UNITS |
|---|----------------------|----------------------------------|-----|-----|-----|-------|
| Propagation Delay Skew Channel-to-Channel (Opposite Direction) (MAX12931 only) | t _{SCOLH} | | | | 2 | ns |
| | t _{SCOHL} | | | | 2 | |
| Peak Eye Diagram Jitter | T _{JIT(PK)} | 25Mbps | | 250 | | ps |
| Rise Time (Figure 1) | t _R | 4.5V ≤ V _{DD_} ≤ 5.5V | | | 1.6 | ns |
| | | 3.0V ≤ V _{DD_} ≤ 3.6V | | | 2.2 | |
| | | 2.25V ≤ V _{DD_} ≤ 2.75V | | | 3 | |
| | | 1.71V ≤ V _{DD_} ≤ 1.89V | | | 4.5 | |
| Fall Time (Figure 1) | t _F | 4.5V ≤ V _{DD_} ≤ 5.5V | | | 1.4 | ns |
| | | 3.0V ≤ V _{DD_} ≤ 3.6V | | | 2 | |
| | | 2.25V ≤ V _{DD_} ≤ 2.75V | | | 2.8 | |
| | | 1.71V ≤ V _{DD_} ≤ 1.89V | | | 5.1 | |

Dynamic Characteristics MAX1293_C/F

(V_{DDA} - V_{GNDA} = 1.71V to 5.5V, V_{DDB} - V_{GNDB} = 1.71V to 5.5V, C_L = 15pF, T_A = -40°C to +125°C, unless otherwise noted. Typical values are at V_{DDA} - V_{GNDA} = 3.3V, V_{DDB} - V_{GNDB} = 3.3V, G_{NDA} = G_{NDB}, T_A = 25°C, unless otherwise noted.) (Notes 2,3)

| PARAMETER | SYMBOL | CONDITIONS | MIN | TYP | MAX | UNITS |
|--|------------------------|---|-----|------|------|-------|
| Common-Mode Transient Immunity | CMTI | IN ₋ = GND ₋ or V _{DD-} (Note 4) | | 50 | | kV/μs |
| Maximum Data Rate | DR _{MAX} | | 150 | | | Mbps |
| Minimum Pulse Width | PW _{MIN} | 2.25V ≤ V _{DD-} ≤ 5.5V | | | 5 | ns |
| | | 1.71V ≤ V _{DD-} ≤ 1.89V | | | 6.67 | |
| Propagation Delay (Figure 1) | t _{PLH} | 4.5V ≤ V _{DD-} ≤ 5.5V | 4.1 | 5.4 | 9.2 | ns |
| | | 3.0V ≤ V _{DD-} ≤ 3.6V | 4.2 | 5.9 | 10.2 | |
| | | 2.25V ≤ V _{DD-} ≤ 2.75V | 4.9 | 7.1 | 13.4 | |
| | | 1.71V ≤ V _{DD-} ≤ 1.89V | 7.1 | 10.9 | 20.3 | |
| | t _{PHL} | 4.5V ≤ V _{DD-} ≤ 5.5V | 4.3 | 5.6 | 9.4 | |
| | | 3.0V ≤ V _{DD-} ≤ 3.6V | 4.4 | 6.2 | 10.5 | |
| | | 2.25V ≤ V _{DD-} ≤ 2.75V | 5.1 | 7.3 | 14.1 | |
| | | 1.71V ≤ V _{DD-} ≤ 1.89V | 7.2 | 10.9 | 21.7 | |
| Pulse Width Distortion | PWD | | 0.3 | 2 | ns | |
| Propagation Delay Skew Part-to-Part (Same Channel) | t _{SPLH} | 4.5V ≤ V _{DD-} ≤ 5.5V | | | 3.7 | ns |
| | | 3.0V ≤ V _{DD-} ≤ 3.6V | | | 4.3 | |
| | | 2.25V ≤ V _{DD-} ≤ 2.75V | | | 6 | |
| | | 1.71V ≤ V _{DD-} ≤ 1.89V | | | 10.3 | |
| | t _{SPHL} | 4.5V ≤ V _{DD-} ≤ 5.5V | | | 3.8 | |
| | | 3.0V ≤ V _{DD-} ≤ 3.6V | | | 4.7 | |
| | | 2.25V ≤ V _{DD-} ≤ 2.75V | | | 6.5 | |
| | | 1.71V ≤ V _{DD-} ≤ 1.89V | | | 11.5 | |
| Propagation Delay Skew Channel-to-Channel (Same Direction) (MAX12930 only) | t _{SCSLH} | | | 2 | ns | |
| | t _{SCSHL} | | | 2 | | |
| Propagation Delay Skew Channel-to-Channel (Opposite Direction) (MAX12931 only) | t _{SCOLH} | | | 2 | ns | |
| | t _{SCOHL} | | | 2 | | |
| Peak Eye Diagram Jitter | t _{JIT(PK)} | 150Mbps | | 90 | ps | |
| Clock Jitter RMS | t _{JCLK(RMS)} | 500kHz Clock Input Rising/Falling Edges | | 6.5 | ps | |

Dynamic Characteristics MAX1293_C/F (continued)

(V_{DDA} - V_{GNDA} = 1.71V to 5.5V, V_{DDB} - V_{GNDB} = 1.71V to 5.5V, C_L = 15pF, T_A = -40°C to +125°C, unless otherwise noted. Typical values are at V_{DDA} - V_{GNDA} = 3.3V, V_{DDB} - V_{GNDB} = 3.3V, G_{NDA} = G_{NDB}, T_A = 25°C, unless otherwise noted.) (Notes 2,3)

| PARAMETER | SYMBOL | CONDITIONS | MIN | TYP | MAX | UNITS |
|-------------------------|----------------|----------------------------------|-----|-----|-----|-------|
| Rise Time (Figure 1) | t _R | 4.5V ≤ V _{DD_} ≤ 5.5V | | | 1.6 | ns |
| | | 3.0V ≤ V _{DD_} ≤ 3.6V | | | 2.2 | |
| | | 2.25V ≤ V _{DD_} ≤ 2.75V | | | 3 | |
| | | 1.71V ≤ V _{DD_} ≤ 1.89V | | | 4.5 | |
| Fall Time (Figure 1) | t _F | 4.5V ≤ V _{DD_} ≤ 5.5V | | | 1.4 | ns |
| | | 3.0V ≤ V _{DD_} ≤ 3.6V | | | 2 | |
| | | 2.25V ≤ V _{DD_} ≤ 2.75V | | | 2.8 | |
| | | 1.71V ≤ V _{DD_} ≤ 1.89V | | | 5.1 | |

- Note 1:** All devices are 100% production tested at T_A = +25°C. Specifications over temperature are guaranteed by design.
- Note 2:** Not production tested. Guaranteed by design and characterization.
- Note 3:** All currents into the device are positive. All currents out of the device are negative. All voltages are referenced to their respective ground (G_{NDA} or G_{NDB}), unless otherwise noted.
- Note 4:** CMTI is the maximum sustainable common-mode voltage slew rate while maintaining the correct output. CMTI applies to both rising and falling common-mode voltage sedges. Tested with the transient generator connected between G_{NDA} and G_{NDB} (V_{CM} = 1000V).

ESD Protection

| PARAMETER | SYMBOL | CONDITIONS | MIN | TYP | MAX | UNITS |
|-----------|--------|----------------------------|-----|-----|-----|-------|
| ESD | | Human Body Model, all pins | | ±3 | | kV |

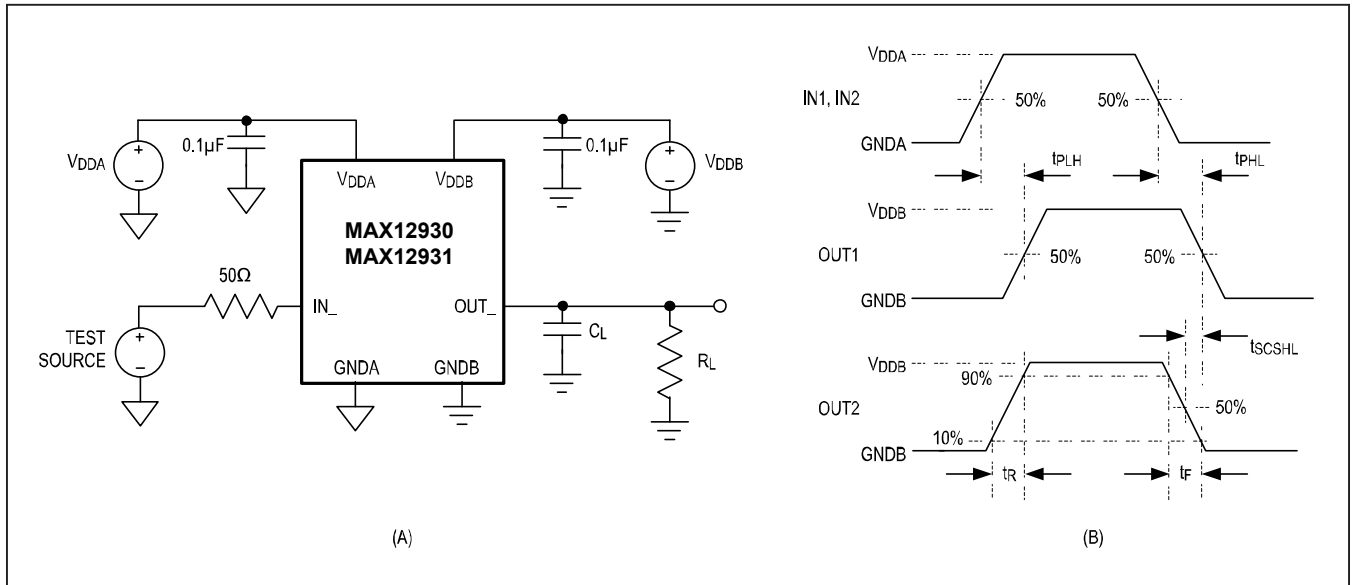

Figure 1. Test Circuit (A) and Timing Diagram (B)

MAX12930/MAX12931

Two-Channel, Low-Power, 3kV_{RMS} and 5kV_{RMS} Digital Isolators

Safety Regulatory Approvals

| |
|---|
| UL |
| The MAX12930–MAX12931 narrow-body SOIC are certified under UL1577. For more details, refer to file E351759. |
| Rated up to 3000V _{RMS} isolation voltage for single protection. |
| cUL (Equivalent to CSA Notice 5A) |
| The MAX12930–MAX12931 narrow-body SOIC are certified up to 3000V _{RMS} for single protection. For more details, refer to file E351759. |

| |
|---|
| UL |
| The MAX12931 wide-body SOIC is certified under UL1577. For more details, refer to file E351759. |
| Rated up to 5000V _{RMS} isolation voltage for single protection. |
| cUL (Equivalent to CSA notice 5A) |
| The MAX12931 wide-body SOIC is certified up to 5000V _{RMS} for single protection. For more details, refer to file E351759. |

| |
|--|
| VDE |
| The MAX12930–MAX12931 narrow-body SOIC are certified to DIN VDE V 0884-11: 2017-01 |
| Basic Insulation, Maximum Transient Isolation Voltage 4200V _{PK} , Maximum Repetitive Peak Isolation Voltage 630V _{PK} . |
| For details, see file ref. 5015017-4880-0001/272147/TL7/SCT. |

These couplers are suitable for “safe electrical insulation” only within the safety ratings. Compliance with the safety ratings shall be ensured by means of suitable protective circuits.

Insulation Characteristics

Table 1. Narrow SOIC Insulation Characteristic

| PARAMETER | SYMBOL | CONDITIONS | VALUE | UNITS |
|---|-------------------|--|--------------------|------------------|
| Partial Discharge Test Voltage | V _{PR} | Method B1 = V _{IORM} × 1.875 (t = 1s, partial discharge < 5pC) | 1182 | V _P |
| Maximum Repetitive Peak Isolation Voltage | V _{IORM} | (Note 5) | 630 | V _P |
| Maximum Working Isolation Voltage | V _{IOWM} | Continuous RMS voltage (Note 5) | 445 | V _{RMS} |
| Maximum Transient Isolation Voltage | V _{IOTM} | t = 1s (Note 5) | 4200 | V _P |
| Maximum Withstand Isolation Voltage | V _{ISO} | f _{SW} = 60Hz, duration = 60s (Note 5, 6) | 3000 | V _{RMS} |
| Maximum Surge Isolation Voltage | V _{IOSM} | Basic Insulation, 1.2/50µs pulse per IEC 61000-4-5 (Note 5, 8) | 5000 | V _P |
| Insulation Resistance | R _{IO} | V _{IO} = 500V, T _A = 25°C | > 10 ¹² | Ω |
| | | V _{IO} = 500V, 100°C ≤ T _A ≤ 125°C | > 10 ¹¹ | |
| | | V _{IO} = 500V at T _S = 150°C | > 10 ⁹ | |
| Barrier Capacitance Side A to Side B | C _{IO} | f _{SW} = 1MHz (Note 7) | 2 | pF |
| Minimum Creepage Distance | CPG | Narrow SOIC | 4 | mm |
| Minimum Clearance Distance | CLR | Narrow SOIC | 4 | mm |
| Internal Clearance | | Distance through insulation | 0.015 | mm |
| Comparative Tracking Index | CTI | Material Group II (IEC 60112) | > 400 | |
| Climate Category | | | 40/125/21 | |
| Pollution Degree (DIN VDE 0110, Table 1) | | | 2 | |

Table 2. Wide SOIC Insulation Characteristic

| PARAMETER | SYMBOL | CONDITIONS | VALUE | UNITS |
|---|-------------------|--|--------------------|------------------|
| Partial Discharge Test Voltage | V _{PR} | Method B1 = V _{IORM} × 1.875 (t = 1s, partial discharge < 5pC) | 2250 | V _P |
| Maximum Repetitive Peak Isolation Voltage | V _{IORM} | (Note 5) | 1200 | V _P |
| Maximum Working Isolation Voltage | V _{IOWM} | Continuous RMS voltage (Note 5) | 848 | V _{RMS} |
| Maximum Transient Isolation Voltage | V _{IOTM} | t = 1s (Note 5) | 8400 | V _P |
| Maximum Withstand Isolation Voltage | V _{ISO} | f _{SW} = 60Hz, duration = 60s (Note 5, 6) | 5000 | V _{RMS} |
| Maximum Surge Isolation Voltage | V _{IOSM} | Basic Insulation, 1.2/50μs pulse per IEC 61000-4-5 (Note 5, 8) | 10000 | V _P |
| Insulation Resistance | R _{IO} | V _{IO} = 500V, T _A = 25°C | > 10 ¹² | Ω |
| | | V _{IO} = 500V, 100°C ≤ T _A ≤ 125°C | > 10 ¹¹ | |
| | | V _{IO} = 500V at T _S = 150°C | > 10 ⁹ | |
| Barrier Capacitance Side A to Side B | C _{IO} | f _{SW} = 1MHz (Note 7) | 2 | pF |
| Minimum Creepage Distance | CPG | Wide SOIC | 8 | mm |
| Minimum Clearance Distance | CLR | Wide SOIC | 8 | mm |
| Internal Clearance | | Distance through insulation | 0.015 | mm |
| Comparative Tracking Index | CTI | Material Group I (IEC 60112) | >600 | |
| Climate Category | | | 40/125/21 | |
| Pollution Degree (DIN VDE 0110, Table 1) | | | 2 | |

Note 5: V_{ISO}, V_{IOTM}, V_{IOSM}, V_{IOWM}, and V_{IORM} are defined by the IEC 60747-5-5 standard.

Note 6: Product is qualified at V_{ISO} for 60s and 100% production tested at 120% of V_{ISO} for 1s.

Note 7: Capacitance is measured with all pins on side A and side B tied together.

Note 8: Devices are immersed in oil during surge characterization.

MAX12930/MAX12931

Two-Channel, Low-Power, 3kV_{RMS} and 5kV_{RMS} Digital Isolators

Safety Limits

Damage to the IC can result in a low-resistance path to ground or to the supply and, without current limiting, the MAX12930–MAX12931 could dissipate excessive amounts of power. Excessive power dissipation can damage the die and result in damage to the isolation barrier, potentially causing downstream issues. [Table 3](#) shows the safety limits for the MAX12930–MAX12931.

The maximum safety temperature (T_S) for the device is the 150°C maximum junction temperature specified in the [Absolute Maximum Ratings](#). The power dissipation (P_D) and junction-to-ambient thermal impedance (θ_{JA}) determine the junction temperature. Thermal impedance values (θ_{JA} and θ_{JC}) are available in the [Package Information](#) section of the datasheet and power dissipation calculations are discussed in the [Calculating Power Dissipation](#) section. Calculate the junction temperature (T_J) as:

$$T_J = T_A + (P_D \times \theta_{JA})$$

[Figure 2](#) and [Figure 3](#) show the thermal derating curves for the safety power limiting of the devices and [Figure 4](#) shows the thermal derating curve for the safety current limiting of the devices. Ensure that the junction temperature does not exceed 150°C.

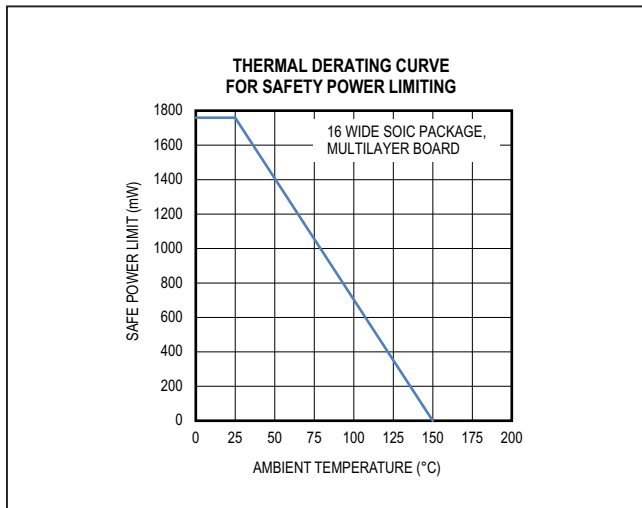

Figure 2. Thermal Derating Curve for Safety Power Limiting—16 Wide SOIC

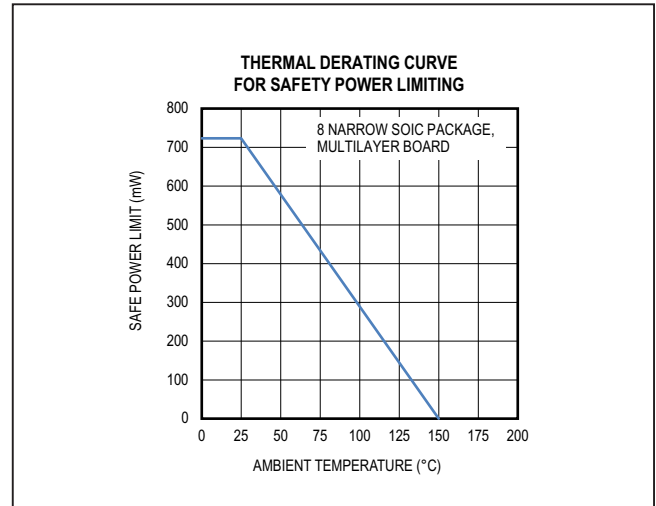

Figure 3. Thermal Derating Curve for Safety Power Limiting—8 Narrow SOIC

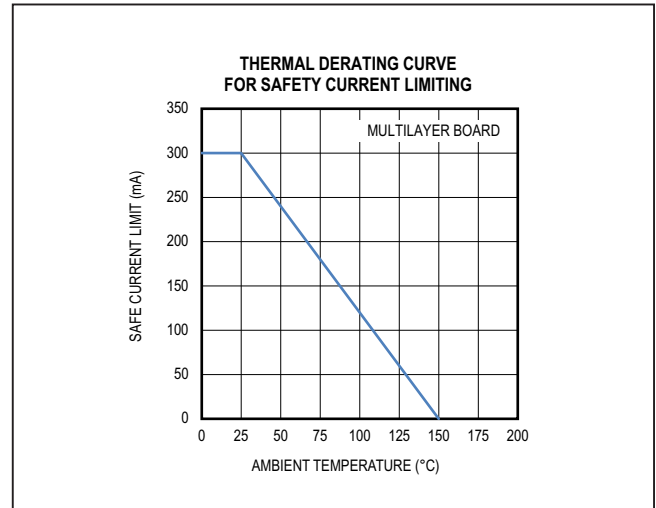

Figure 4. Thermal Derating Curve for Safety Current Limiting

Table 3. Safety Limiting Values for the MAX12930–MAX12931

| PARAMETER | SYMBOL | TEST CONDITIONS | MAX | UNITS |
|--|----------------|---|---------------|-------|
| Safety Current on Any Pin (No Damage to Isolation Barrier) | I _S | T _J = 150°C, T _A = 25°C | 300 | mA |
| Total Safety Power Dissipation | P _S | T _J = 150°C, T _A = 25°C | 16 Wide SOIC | 1760 |
| | | | 8 Narrow SOIC | 723 |
| Maximum Safety Temperature | T _S | | 150 | °C |

Typical Operating Characteristics

(V_{VDDA} - V_{GNDA} = +3.3V, V_{VDDB} - V_{GNDB} = +3.3V, V_{GNDA} = V_{GNDB}, T_A = +25°C, unless otherwise noted.)

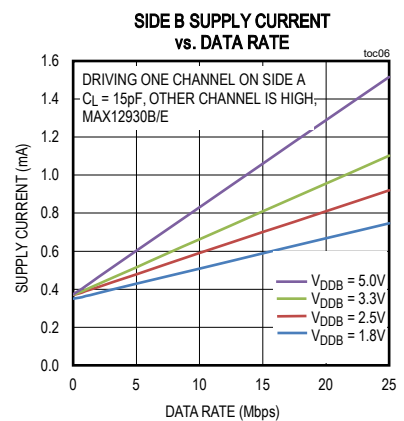
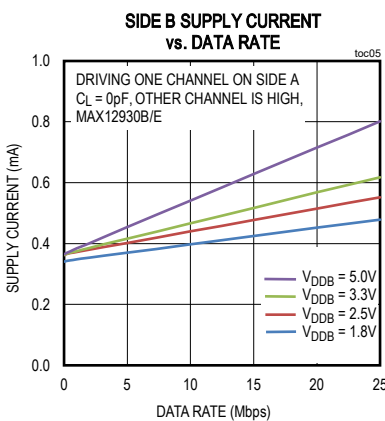
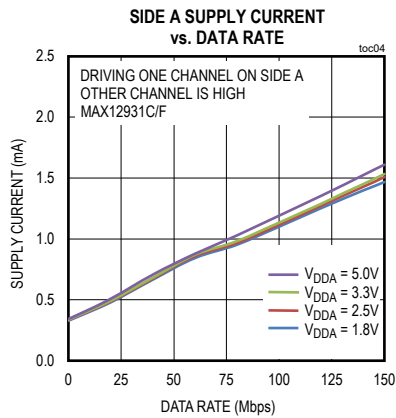
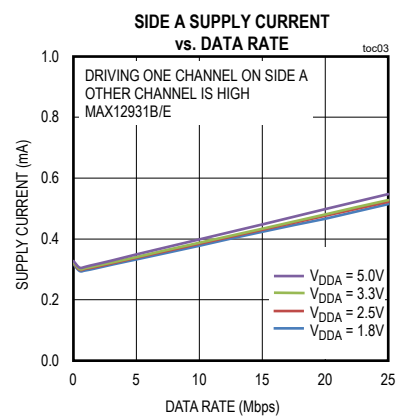
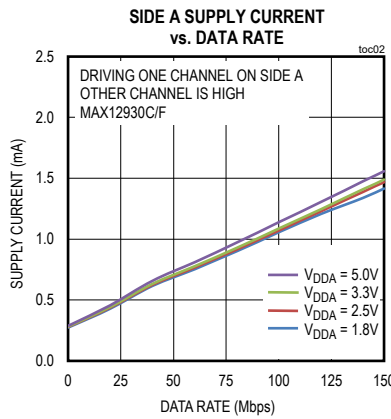
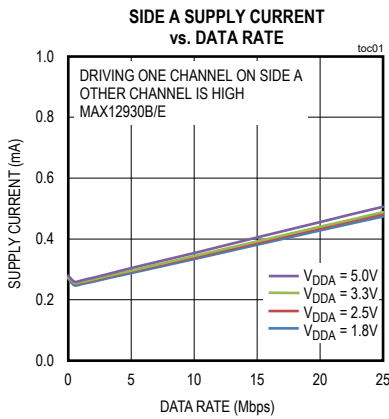

Typical Operating Characteristics (continued)

(V_{VDDA} - V_{GNDA} = +3.3V, V_{VDDB} - V_{GNDB} = +3.3V, V_{GNDA} = V_{GNDB}, T_A = +25°C, unless otherwise noted.)

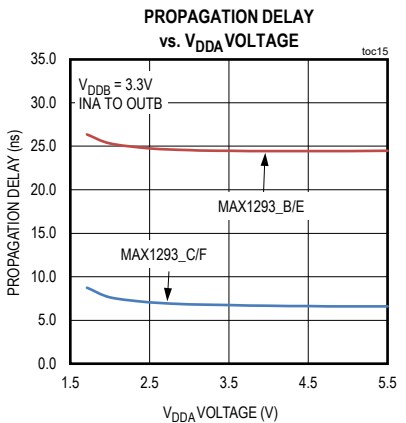
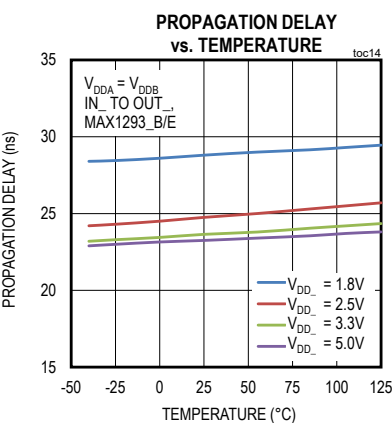
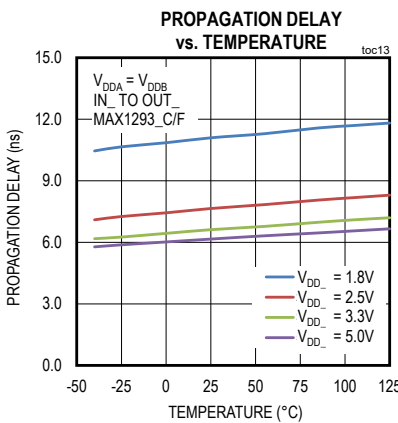
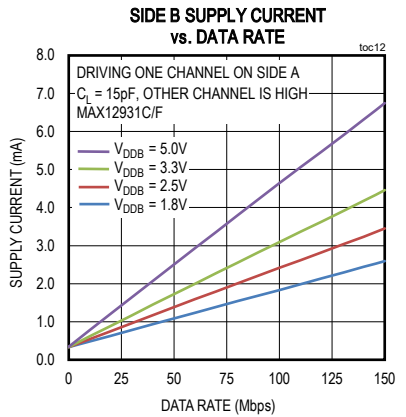
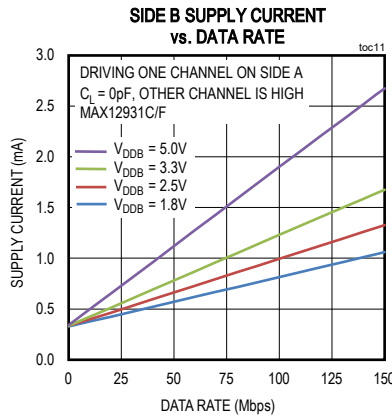
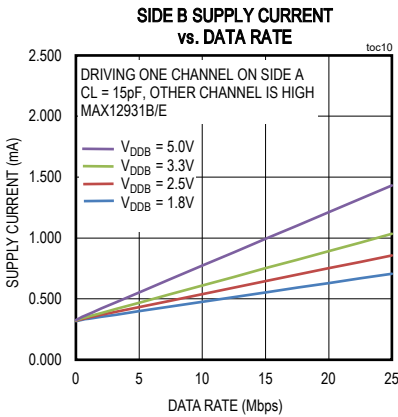
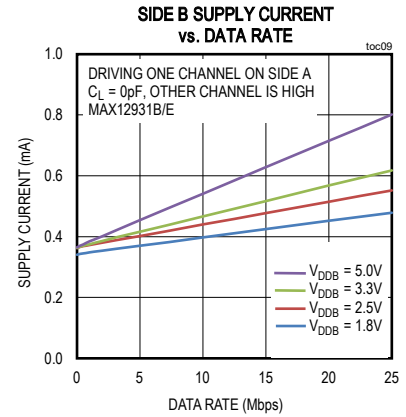
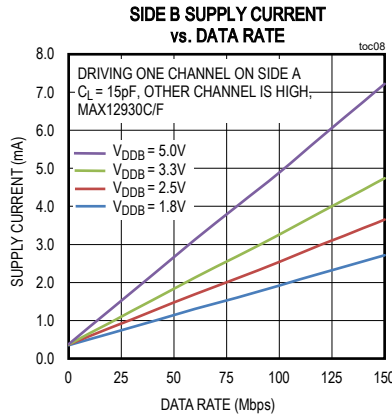
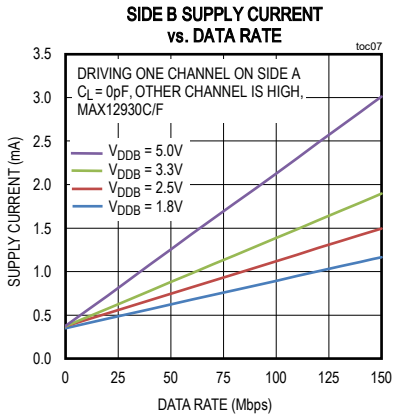

Typical Operating Characteristics (continued)

(V_{VDDA} - V_{GNDA} = +3.3V, V_{VDDB} - V_{GNDB} = +3.3V, V_{GNDA} = V_{GNDB}, T_A = +25°C, unless otherwise noted.)

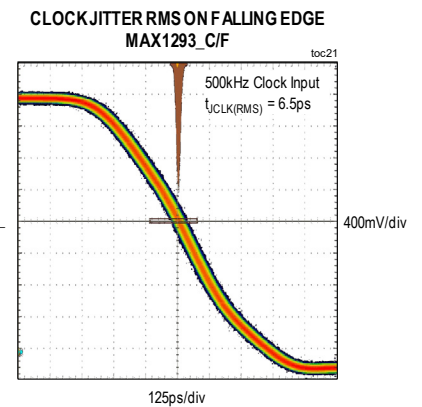
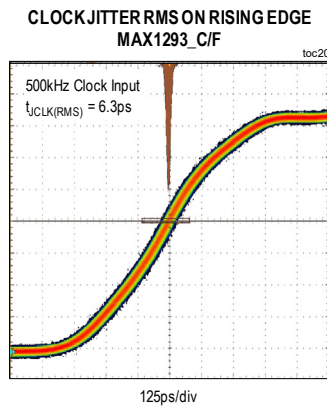
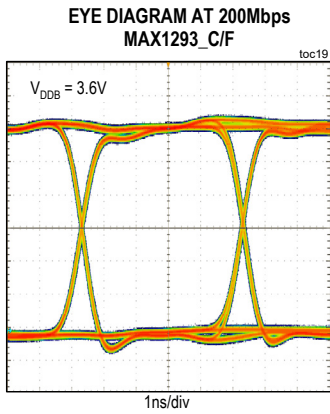
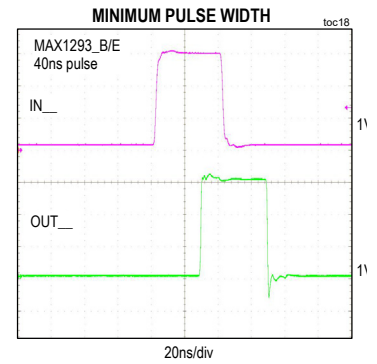
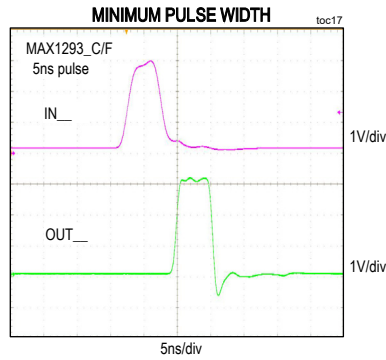
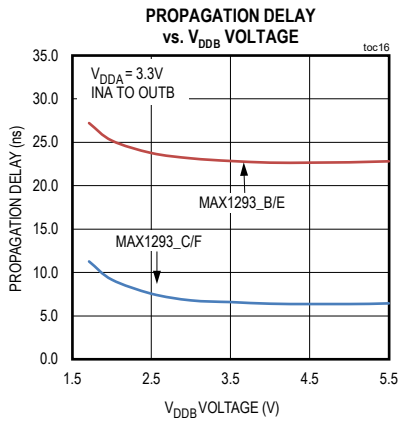

MAX12930/MAX12931

Two-Channel, Low-Power,
3kV_{RMS} and 5kV_{RMS} Digital Isolators

Pin Configurations

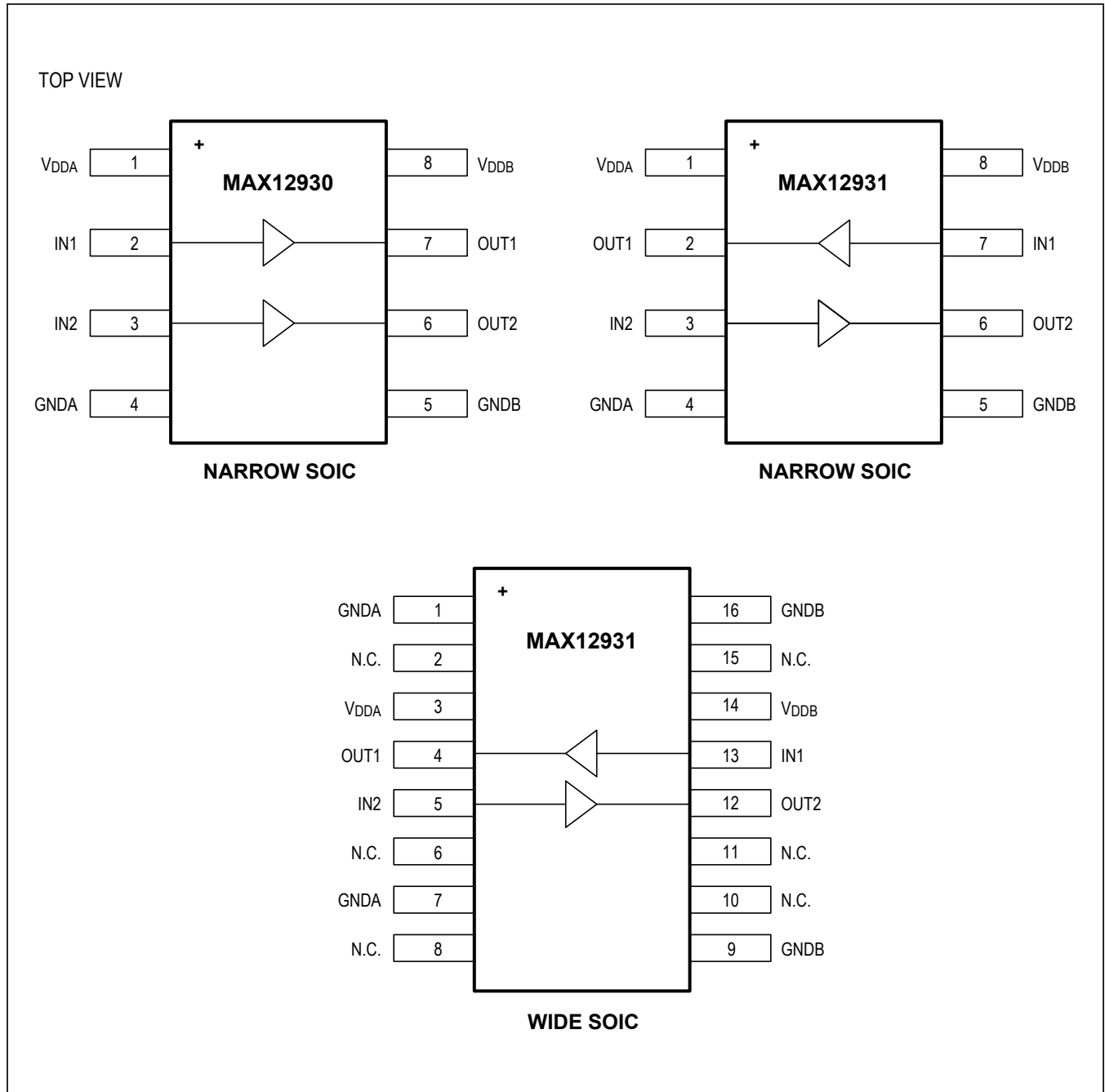

Pin Description

| PIN | | | NAME | FUNCTION | REFERENCE |
|---------------------|---------------------|----------------------|------------------|--|-----------|
| MAX12930 8-PIN SOIC | MAX12931 8-PIN SOIC | MAX12931 16-PIN SOIC | | | |
| 1 | 1 | 3 | V _{DDA} | Power Supply for side A. Bypass V _{DDA} with a 0.1µF ceramic capacitor to GNDA. | GNDA |
| 2 | — | — | IN1 | Logic input for channel 1 | GNDA |
| — | 2 | 4 | OUT1 | Logic output of channel 1 | GNDA |
| 3 | 3 | 5 | IN2 | Logic input for channel 2 | GNDA |
| 4 | 4 | 1, 7 | GNDA | Ground reference for side A | — |
| 5 | 5 | 9, 16 | GNDB | Ground reference for side B | — |
| 6 | 6 | 12 | OUT2 | Logic output of channel 2 | GNDB |
| 7 | — | — | OUT1 | Logic output of channel 1 | GNDB |
| — | 7 | 13 | IN1 | Logic input for channel 1 | GNDB |
| 8 | 8 | 14 | V _{DDB} | Power Supply for side B. Bypass V _{DDB} with a 0.1µF ceramic capacitor to GNDB. | GNDB |
| — | — | 2, 6, 8, 10, 11, 15 | N.C. | Not internally connected | — |

Typical Application Circuits

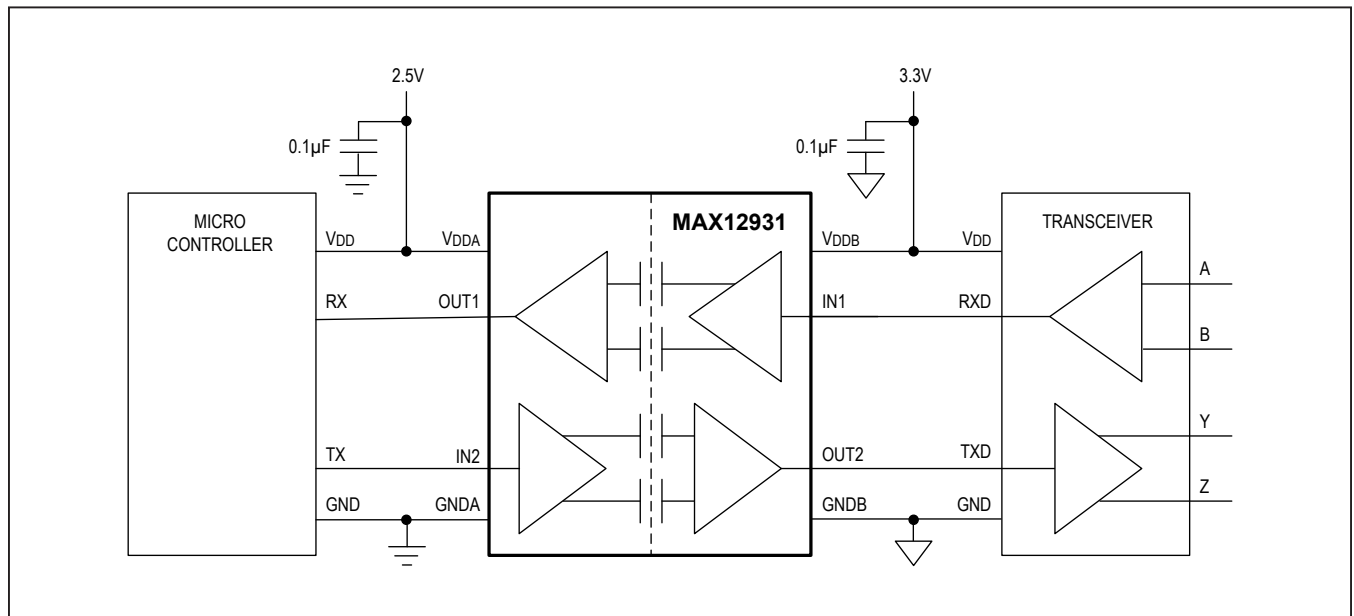

Detailed Description

The MAX12930/MAX12931 are a family of 2-channel digital isolators. The MAX12930 transfers digital signals between circuits with different power domain in one direction, which is convenient for applications such as digital I/O. The MAX12931 transfers digital signals in opposite directions, which is necessary for isolated RS-485 or other UART applications.

Devices available in the 8-pin narrow body SOIC package are rated for up to 3kV_{RMS} isolation voltage for 60 seconds and the device in the 16-pin wide body SOIC package is rated for up to 5kV_{RMS}. This family of digital isolators offers low-power operation, high electromagnetic interference (EMI) immunity, and stable temperature performance through Maxim’s proprietary process technology. The devices isolate different ground domains and block high-voltage/high-current transients from sensitive or human interface circuitry.

Devices are available with data rates from DC to 25Mbps (B/E versions) or 150Mbps (C/F versions). Each device can be ordered with default-high or default-low outputs. The default is the state the output assumes when the input is not powered, or if the input is open circuit.

The devices have two supply inputs (V_{DDA} and V_{ddb}) that independently set the logic levels on either side of device. V_{DDA} and V_{ddb} are referenced to GNDA and GNDB, respectively. The MAX12930/MAX12931 family also features a refresh circuit to ensure output accuracy when an input remains in the same state indefinitely.

Digital Isolation

The device family provides galvanic isolation for digital signals that are transmitted between two ground domains. Up to 630V_{PEAK} of continuous isolation is supported

in the narrow SOIC package and up to 1200V_{PEAK} of continuous isolation is supported in the wide SOIC package. The devices withstand differences of up to 3kV_{RMS} in the 8-pin narrow SOIC package or 5kV_{RMS} in the 16-pin wide SOIC package for up to 60 seconds.

Level-Shifting

The wide supply voltage range of both V_{DDA} and V_{ddb} allows the MAX12930/MAX12931 family to be used for level translation in addition to isolation. V_{DDA} and V_{ddb} can be independently set to any voltage from 1.71V to 5.5V. The supply voltage sets the logic level on the corresponding side of the isolator.

Unidirectional Channels

Each channel of the MAX12930/MAX12931 is unidirectional; it only passes data in one direction, as indicated in the functional diagram. Each device features two unidirectional channels that operate independently with guaranteed data rates from DC up to 25Mbps (B/E versions), or DC to 150Mbps (C/F versions). The output driver of each channel is push-pull, eliminating the need for pullup resistors. The outputs are able to drive both TTL and CMOS logic inputs.

Startup and Undervoltage-Lockout

The V_{DDA} and V_{ddb} supplies are both internally monitored for undervoltage conditions. Undervoltage events can occur during power-up, power-down, or during normal operation due to a sagging supply voltage. When an undervoltage condition is detected on either supply, all outputs go to their default states regardless of the state of the inputs (Table 4). Figure 5 through Figure 8 show the behavior of the outputs during power-up and power-down.

Table 4. Output Behavior During Undervoltage Conditions

| V _{IN_} | V _{DDA} | V _{ddb} | V _{OUTA_} | V _{OUTB_} |
|------------------|------------------|------------------|--------------------|--------------------|
| 1 | Powered | Powered | 1 | 1 |
| 0 | Powered | Powered | 0 | 0 |
| X | Undervoltage | Powered | Default | Default |
| X | Powered | Undervoltage | Default | Default |

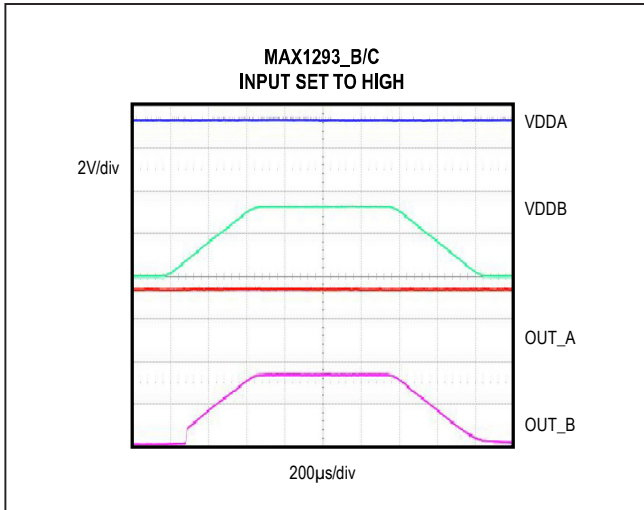

Figure 5. Undervoltage Lockout Behavior (MAX1293_B/C High)

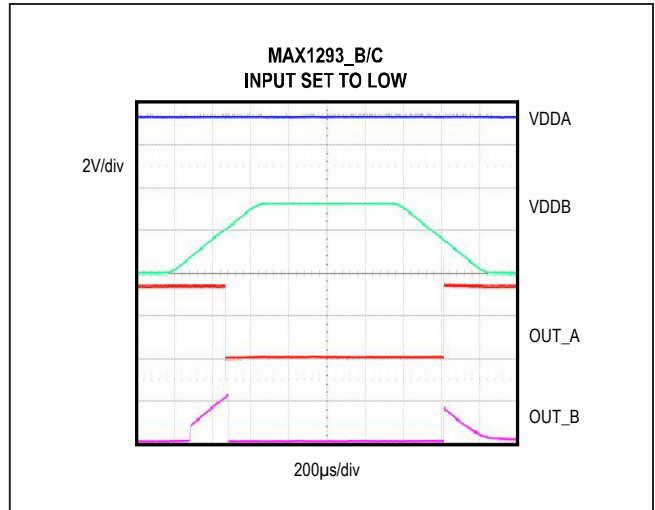

Figure 6. Undervoltage Lockout Behavior (MAX1293_B/C Low)

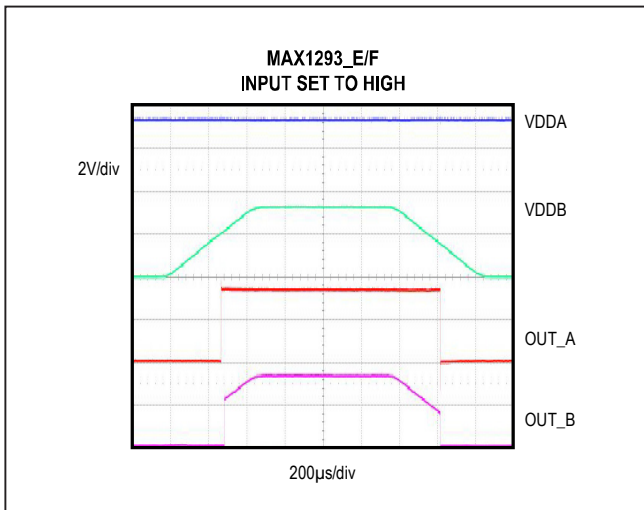

Figure 7. Undervoltage Lockout Behavior (MAX1293_E/F High)

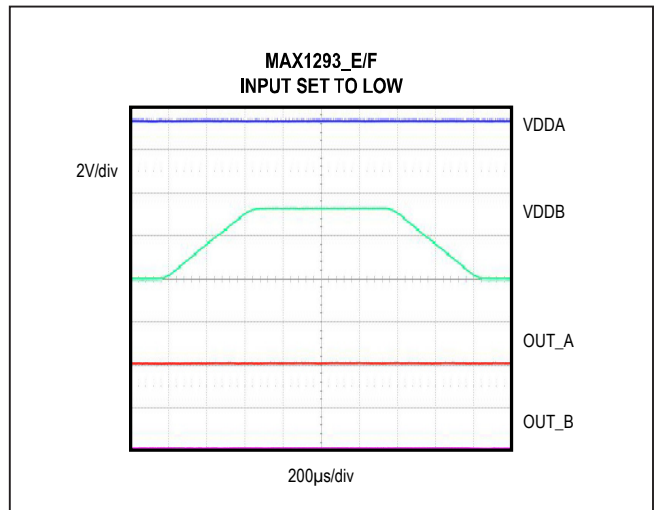

Figure 8. Undervoltage Lockout Behavior (MAX1293_E/F Low)

Application Information

Power-Supply Sequencing

The MAX12930/MAX12931 do not require special power supply sequencing. The logic levels are set independently on either side by V_{DDA} and V_{DDB}. Each supply can be present over the entire specified range regardless of the level or presence of the other supply.

Power-Supply Decoupling

To reduce ripple and the chance of introducing data errors, bypass V_{DDA} and V_{DDB} with 0.1µF low-ESR ceramic capacitors to GNDA and GNDB, respectively. Place the bypass capacitors as close to the power supply input pins as possible.

Layout Considerations

The PCB designer should follow some critical recommendation in order to get the best performance from the design.

- Keep the input/output traces as short as possible. To keep signal paths low-inductance, avoid using vias.
- Have a solid ground plane underneath the high-speed signal layer.
- Keep the area underneath the MAX12930/MAX12931 free from ground and signal planes. Any galvanic or metallic connection between the field-side and logic-side defeats the isolation.

Calculating Power Dissipation

The required current for a given supply (V_{DDA} or V_{DDB}) can be estimated by summing the current required for each channel. The supply current for a channel depends on whether the channel is an input or an output, the channel's data rate, and the capacitive or resistive load if it is an output. The typical current for an input or output at any data rate can be estimated from the graphs in [Figure 9](#) and [Figure 10](#). Please note that the data in [Figure 9](#) and [Figure 10](#) are extrapolated from the supply current measurements in a typical operating condition.

The total current for a single channel is the sum of the “no load” current (shown in [Figure 9](#) and [Figure 10](#)) which is a function of Voltage and Data Rate, and the “load current” which depends upon the type of load. Current into a capacitive load is a function of the load capacitance, the switching frequency, and the supply voltage.

$$I_{CL} = C_L \times f_{SW} \times V_{DD}$$

where,

I_{CL} = Current required to drive the capacitive load.

C_L = Load capacitance on the isolator's output pin.

f_{SW} = Switching frequency (bits per second/2).

V_{DD} = Supply voltage on the output side of the isolator.

Current into a resistive load depends on the load resistance, the supply voltage and the average duty cycle of the data waveform. The DC load current can be conservatively estimated by assuming the output is always high.

$$I_{RL} = V_{DD} \div R_L$$

where,

I_{RL} = Current required to drive the resistive load.

V_{DD} = Supply voltage on the output side of the isolator.

R_L = Load resistance on the isolator's output pin.

Example (shown in [Figure 11](#)): A MAX12931F is operating with V_{DDA} = 2.5V, V_{DDB} = 3.3V, channel 1 operating at 100Mbps with a 15pF capacitive load, and channel 2 operating at 20Mbps with a 10pF capacitive load. Refer to [Table 5](#) and [Table 6](#) for V_{DDA} and V_{DDB} supply current calculation worksheets.

V_{DDA} must supply:

Channel 1 is an output channel operating at 2.5V and 100Mbps, consuming 1.02mA, estimated from [Figure 10](#). Channel 2 is an input channel operating at 2.5V and 20Mbps, consuming 0.33mA, estimated from [Figure 9](#). I_{CL} on channel 1 for 15pF capacitor at 2.5V and 100Mbps is 1.875mA.

Total current for side A = 1.02 + 0.33 + 1.875 = 3.225mA, typical

V_{DDB} must supply:

Channel 1 is an input channel operating at 3.3V and 100Mbps, consuming 1.13mA, estimated from [Figure 9](#). Channel 2 is an output channel operating at 3.3V and 20Mbps, consuming 0.42mA, estimated from [Figure 10](#). I_{CL} on channel 2 for 10pF capacitor at 3.3V and 20Mbps is 0.33mA.

Total current for side B = 1.13 + 0.42 + 0.33 = 1.88mA, typical

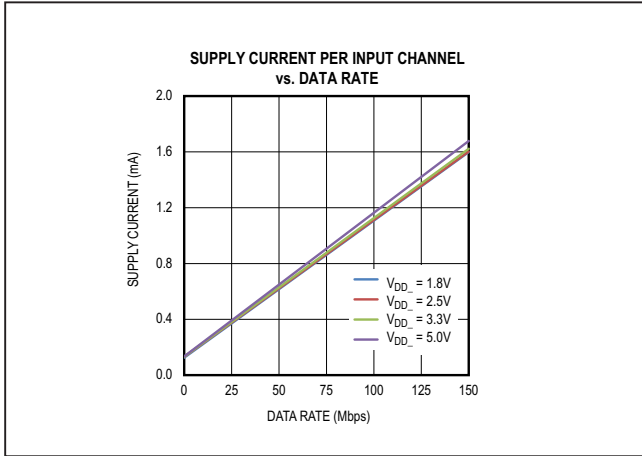

Figure 9. Supply Current per Input Channel Versus Data Rate

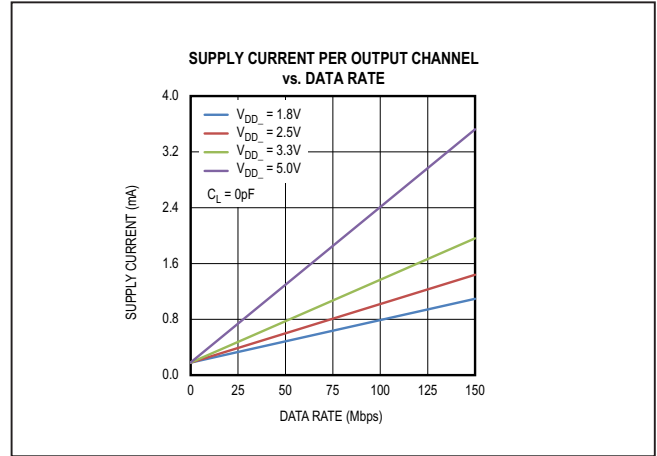

Figure 10. Supply Current per Output Channel Versus Data Rate

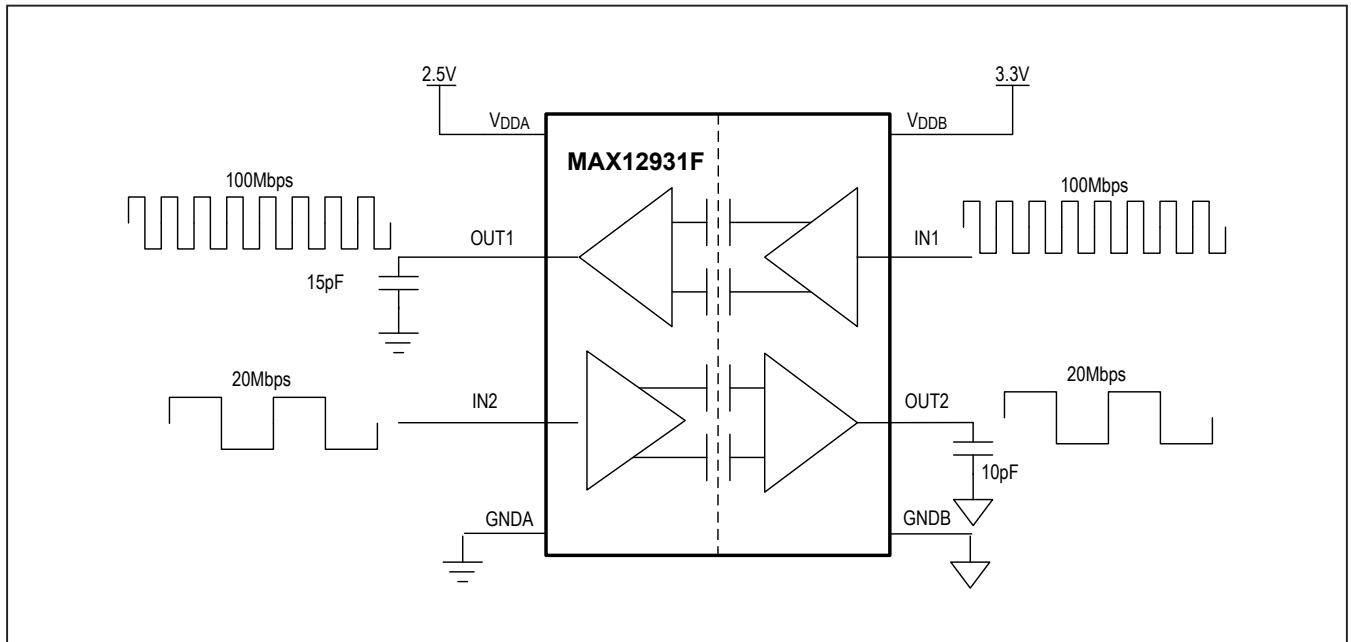

Figure 11. Example Circuit for Supply Current Calculation

Table 5. Side A Supply Current Calculation Worksheet

| SIDE A | | V _{DDA} = 2.5V | | | | |
|---------|--------|-------------------------|------------|------|------------------------|-------------------------------|
| CHANNEL | IN/OUT | FREQUENCY (Mbps) | LOAD TYPE | LOAD | “NO LOAD” CURRENT (mA) | LOAD CURRENT (mA) |
| 1 | OUT | 100 | Capacitive | 15pF | 1.02 | 2.5V x 50MHz x 15pF = 1.875mA |
| 2 | IN | 20 | | | 0.33 | |
| Total: | | | | | 3.225mA | |

Table 6. Side B Supply Current Calculation Worksheet

| SIDE B | | V _{DDB} = 3.3V | | | | |
|---------|--------|-------------------------|------------|------|------------------------|------------------------------|
| CHANNEL | IN/OUT | FREQUENCY (Mbps) | LOAD TYPE | LOAD | “NO LOAD” CURRENT (mA) | LOAD CURRENT (mA) |
| 1 | IN | 100 | | | 1.13 | |
| 2 | OUT | 20 | Capacitive | 10pF | 0.42 | 3.3V x 10MHz x 10pF = 0.33mA |
| Total: | | | | | 1.88mA | |

MAX12930/MAX12931

Two-Channel, Low-Power,
3kV_{RMS} and 5kV_{RMS} Digital Isolators

Product Selector Guide

The diagram shows the pin configurations for the MAX12930 and MAX12931. The pins are labeled 1, F, A, S, A, +. The configurations are as follows:

- CHANNEL CONFIGURATION:** 0: 2/0, 1: 1/1
- MAXIMUM DATA RATE DEFAULT OUTPUT (SEE TABLE):** F
- TEMP RANGE: -40°C TO +125°C:** A
- PACKAGE:** S: N SOIC, W: W SOIC
- PINS:** A: 8, E: 16
- LEAD-FREE/ROHS COMPLIANT:** +

| DEVICE CONFIGURATION | MAX DATA RATE | |
|----------------------|---------------|----------|
| | 25 Mbps | 150 Mbps |
| DEFAULT-HIGH OUTPUT | B | C |
| DEFAULT-LOW OUTPUT | E | F |

Ordering Information

| PART | CHANNEL CONFIGURATION | DATA RATE (Mbps) | DEFAULT OUTPUT | ISOLATION VOLTAGE (kV _{RMS}) | TEMP RANGE | PIN-PACKAGE |
|-----------------------|-----------------------|------------------|----------------|--|----------------|---------------|
| MAX12930 BASA+ | 2/0 | 25 | High | 3 | -40°C to 125°C | 8 Narrow SOIC |
| MAX12930CASA+ | 2/0 | 150 | High | 3 | -40°C to 125°C | 8 Narrow SOIC |
| MAX12930EASA+ | 2/0 | 25 | Low | 3 | -40°C to 125°C | 8 Narrow SOIC |
| MAX12930FASA+ | 2/0 | 150 | Low | 3 | -40°C to 125°C | 8 Narrow SOIC |
| MAX12931 BASA+ | 1/1 | 25 | High | 3 | -40°C to 125°C | 8 Narrow SOIC |
| MAX12931CASA+ | 1/1 | 150 | High | 3 | -40°C to 125°C | 8 Narrow SOIC |
| MAX12931EASA+ | 1/1 | 25 | Low | 3 | -40°C to 125°C | 8 Narrow SOIC |
| MAX12931FASA+ | 1/1 | 150 | Low | 3 | -40°C to 125°C | 8 Narrow SOIC |
| MAX12931BAWE+ | 1/1 | 25 | High | 5 | -40°C to 125°C | 16 Wide SOIC |

+Denotes a lead(Pb)-free/RoHS-compliant package.

Chip Information

PROCESS: BICMOS