

MAX12934/MAX12935 Evaluation Kits

Evaluates: MAX12934, MAX12935

General Description

The MAX12934/MAX12935 evaluation kit (EV kit) provides a proven design to evaluate the MAX12934 or MAX12935 two channel, wide-body digital isolators.

The EV kit should be powered from two independent isolated power supplies with nominal output voltage in range from 1.71V to 5.5V. For evaluating the electrical parameters of the device without any isolation between the two sides, a single power supply can also be used.

The MAX1293XWEVKIT# comes with U1 populated and supports the following digital isolators: MAX12934BAWE+, MAX12934CAWE+, MAX12934EAWA+, MAX12934FAWE+, MAX12935BAWE+, MAX12935CAWE+, MAX12935EAWA+, MAX12935FAWE+

Features

- Broad Range of Data Transfer Rates (from DC to 200Mbps)
- Two Unidirectional Channels in the Same Direction (MAX12934) or Two Unidirectional Channels in the Opposite Direction (MAX12935)
- SMA Connectors for Easy Connection to External Equipment
- Wide Power Supply Voltage Range from 1.71V to 5.5V
- Guaranteed Up to 5kV_{RMS} Isolation (for the Wide-Body SOIC Package) for 60s

[Ordering Information](#) appears at end of data sheet.

Table 1. EV Kit Options

EVKIT PART #	TARGET DEVICE	PACKAGE TYPE	COMMENT
MAX12934BWEVKIT#	MAX12934BAWE+	16 SOIC Wide-Body	2 channel, 2/0, 25Mbps IC
MAX12934FWEVKIT#	MAX12934FAWE+	16 SOIC Wide-Body	2 channel, 2/0, 200Mbps IC
MAX12935BWEVKIT#	MAX12935BAWE+	16 SOIC Wide-Body	2 channel, 1/1, 25Mbps IC
MAX12935FWEVKIT#	MAX12935FAWE+	16 SOIC Wide-Body	2 channel, 1/1, 200Mbps IC
MAX1293XWEVKIT#	MAX1293_AWE+	16 SOIC Wide-Body	Unpopulated EV kit. Supports any isolator in the family; U1 must be ordered separately.

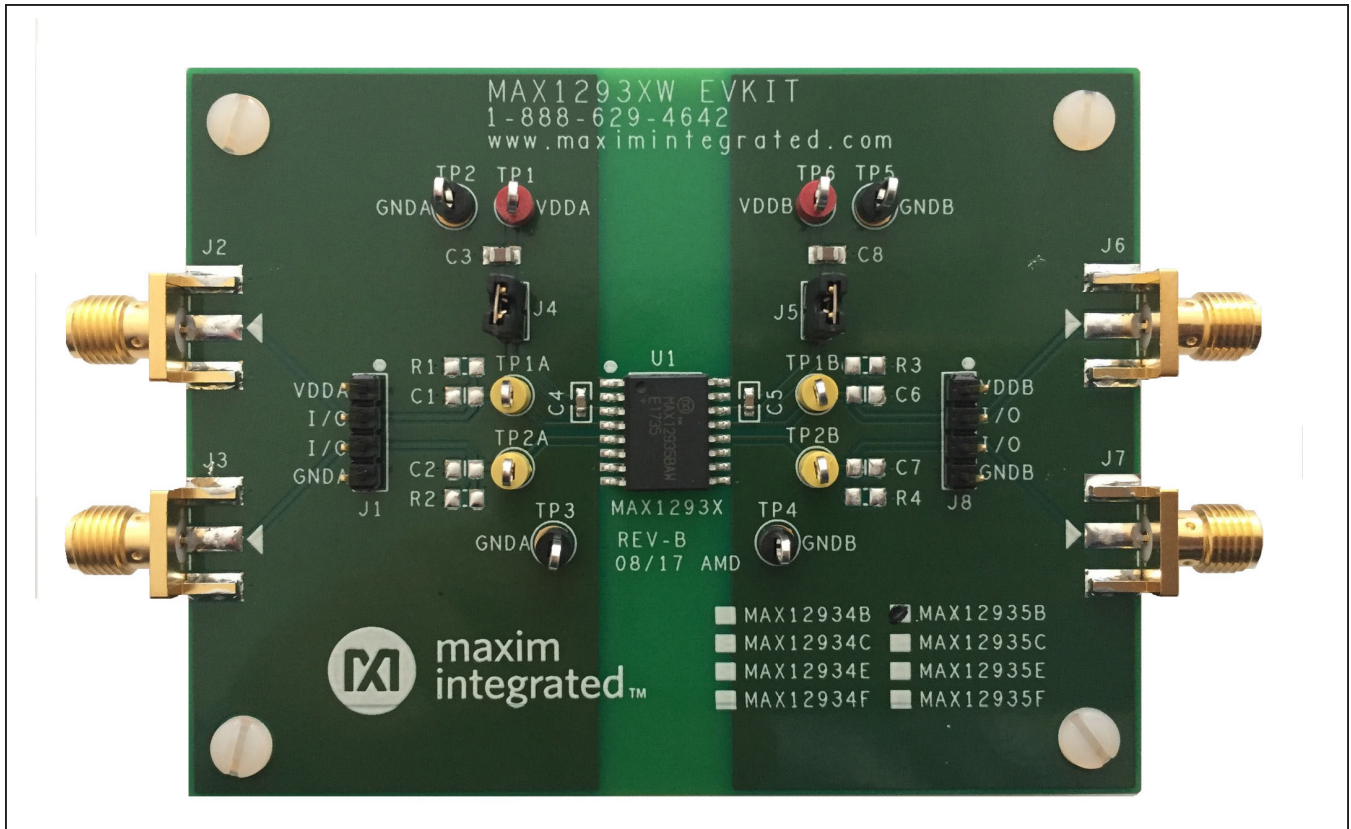

Figure 1. Wide-Body MAX12934XW/MAX12935XW EV Kit

Quick Start

Required Equipment

- MAX12934XW or MAX12935XW EV kit
- Two adjustable +5V DC power supplies
- Signal/function generator
- Oscilloscope

Procedure

The MAX12934XW and MAX12935XW EV kits are fully assembled and ready for evaluation. Follow the steps below to verify board functionality:

- 1) Connect the DC power supplies between the MAX1293x EV kit's V_{DDA}/V_{DDB} and $GNDA/GNDB$ test points.
- 2) Turn on the DC power supplies and set them between 1.71V and 5.5V, then enable the power supply output. **Note:** It is also possible to power the MAX1293X EV kit from a single power supply to test electrical parameters but this invalidates the digital isolation of the IC.
- 3) Connect the signal/function generator to the SMA connectors or test points of side A and observe the isolated signal on the other side, side B, using an oscilloscope.

Table 2. MAX12934xS, MAX12935xS, and MAX12935BW Board Connectors and Shunt Positions

CONNECTOR	SHUNT POSITION	DESCRIPTION
J1	1	Test point or input header for V_{DDA}
	2	Test point or input header for I/O; same as J2 SMA
	3	Test point or input header for I/O; same as J3 SMA
	4	Test point or input header for $GNDA$
J2 (SMA)	n/a	I/O on side A
J3 (SMA)	n/a	I/O on side A
J4	Open	Use ampere meter to measure current of side A
	1-2*	Connect power supply to V_{DDA}
J5	Open	Use ampere meter to measure current of side B
	1-2*	Connect power supply to V_{DDB}
J6 (SMA)	n/a	I/O on side B
J7 (SMA)	n/a	I/O on side B
J8	1	Test point or input header for V_{DDB}
	2	Test point or input header for I/O; same as J6 SMA
	3	Test point or input header for I/O; same as J7 SMA
	4	Test point or input header for $GNDB$

*Default configuration

Table 3. MAX12934xS, MAX12935xS, and MAX12935BW Test Points

TEST POINT	DESCRIPTION
TP1	Test point for V_{DDA}
TP1A	Test point for SMA connector J2
TP1B	Test point for SMA connector J6
TP2, TP3	Test point for $GNDA$
TP2A	Test point for SMA connector J3
TP2B	Test point for SMA connector J7
TP4, TP5	Test point for $GNDB$
TP6	Test point for V_{DDB}

Detailed Description of Hardware

The MAX12934XW and MAX12935XW EV kits are powered from two external adjustable power supplies as described below.

External Power Supplies

Power to the MAX12934XW and MAX12935XW EV kits are derived from two external sources which can both be between +1.71V and +5.5V. Connect one source between the V_{DDA} and GNDA test points, and another source between the V_{DDDB} and GNDB test points. Each supply can be set independently and can be present over the entire range from 1.71V to 5.5V, regardless of the level or presence of the other supply. The MAX12934/MAX12935 level-shifts the data, transmitting them across the isolation barrier.

Two SMA connectors on each side of the board allow easy connections to signal generator(s) and oscilloscope. A typical application diagram is shown in [Figure 2](#).

Decoupling Capacitors

Each power supply is decoupled with a 10µF ceramic capacitor placed close to the power supply test point, and a 0.1µF ceramic capacitor placed close to U1.

Termination

Each input and output has an unpopulated 0805 SMT resistor (R1–R4) and a 0805 SMT capacitor (C1, C2, C6, C7) to GND_ to allow termination based on customer requirements.

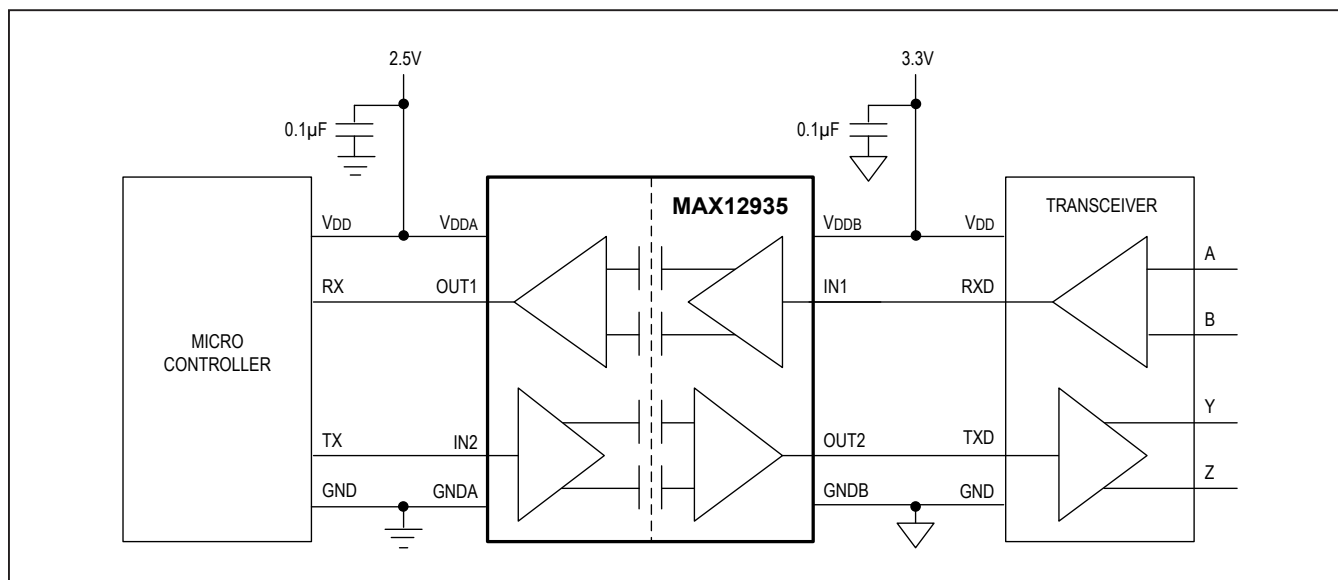

Figure 2. Typical Application Diagram

Ordering Information

PART	TYPE
MAX12934BWEVKIT#*	EV Kit with installed MAX12934BAWE+
MAX12934FWEVKIT#*	EV Kit with installed MAX12934FAWE+
MAX12935BWEVKIT#	EV Kit with installed MAX12935BAWE+
MAX12935FWEVKIT#*	EV Kit with installed MAX12935FAWE+
MAX1293XWEVKIT#	EV Kit without installed isolator. U1 digital isolator must be ordered separately.

#Denotes RoHS compliant.

*Future product—contact factory for availability.

MAX1293XW EV Kit Bill of Materials

ITEM	REF_DES	DNI/D NP	QTY	MFG PART #	MANUFACTU RER	VALUE	DESCRIPTION
1	C3, C8	-	2	ECJ-2FF1A106Z; CC0805ZKY5V6BB1	PANASONIC/Y AGEO PHYCOMP	10UF	CAPACITOR; SMT (0805); CERAMIC CHIP; 10UF; 10V; TOL=+80%-20%; MODEL=Y5V; TG= -30 DEGC TO +85 DEGC; T;
2	C4, C5	-	2	GRM188R61C104KA01; EMK107BJ104KAH	MURATA/TAIY O YUDEN	0.1UF	CAPACITOR; SMT (0603); CERAMIC CHIP; 0.1UF; 16V; TOL=10%; MODEL=; TG=-55 DEGC TO +125 DEGC; TC=X5R;
3	J1, J8	-	2	PEC04SAAN	SULLINS ELECTRONICS CORP.	PEC04SAAN	CONNECTOR; MALE; THROUGH HOLE; BREAKAWAY; STRAIGHT; 4PINS
4	J2, J3, J6, J7	-	4	142-0701-851	JOHNSON COMPONENTS	142-0701-851	CONNECTOR; END LAUNCH JACK RECEPTACLE; BOARDMOUNT; STRAIGHT THROUGH; 2PINS; CONNECTOR; MALE; THROUGH HOLE; BREAKAWAY; STRAIGHT THROUGH; 2PINS; -65 DEGC TO +125 DEGC
5	J4, J5	-	2	PCC02SAAN	SULLINS	PCC02SAAN	TEST POINT; JUMPER; STR; TOTAL LENGTH=0.256IN; BLACK; INSULATION=PBT CONTACT=PHOSPHOR BRONZE; COPPER PLATED TIN OVERALL
6	SU1, SU2	-	2	STC02SYAN	SULLINS ELECTRONICS CORP.	STC02SYAN	TESTPOINT WITH 1.80MM HOLE DIA, RED, MULTIPURPOSE;
7	TP1, TP6	-	2	5010	KEYSTONE	N/A	TEST POINT; PIN DIA=0.125IN; TOTAL LENGTH=0.35IN; BOARD HOLE=0.063IN; YELLOW; PHOSPHOR BRONZE WIRE SILVER PLATE FINISH;
8	TP1A, TP1B, TP2A, TP2B	-	4	5009	KEYSTONE	N/A	TEST POINT; PIN DIA=0.125IN; TOTAL LENGTH=0.445IN; BOARD HOLE=0.063IN; BLACK; PHOSPHOR BRONZE WIRE SILVER PLATE FINISH;
9	TP2-TP5	-	4	5011	KEYSTONE	N/A	TEST POINT; PIN DIA=0.125IN; TOTAL LENGTH=0.445IN; BOARD HOLE=0.063IN; BLACK; PHOSPHOR BRONZE WIRE SILVER PLATE FINISH;
10	MTH1-MTH4	DNI	4	EVKIT_STANDOFF_4-40_3/8	?	EVKIT_STAND OFF_4-40_3/8	KIT; ASSY-STANDOFF 3/8IN; 1PC. STANDOFF/FEM/HEX/4-40IN/(3/8IN)/NYLON; 1PC. SCREW/SLOT/PAN/4-40IN/(3/8IN)/NYLON
11	C1, C2, C6, C7	DNP	0	GRM2195C1H103JA01	MURATA	0.01UF	CAPACITOR; SMT; 0805; CERAMIC; 0.01uF; 50V; 5%; COG; -55degC to + 125degC; 0?30ppm/?C from -55degC to +125degC
12	R1-R4	DNP	0	ERJ-P06J472V	PANASONIC	4.7K	RESISTOR; 0805; 4.7K OHM; 5%; 200PPM; 0.25W; THICK FILM
13	PCB	-	1	MAX1293XBW	MAXIM	PCB	PCB Board:MAX1293BW EVALUATION KIT
TOTAL			29				

MAX1293XW EV Kit Schematic

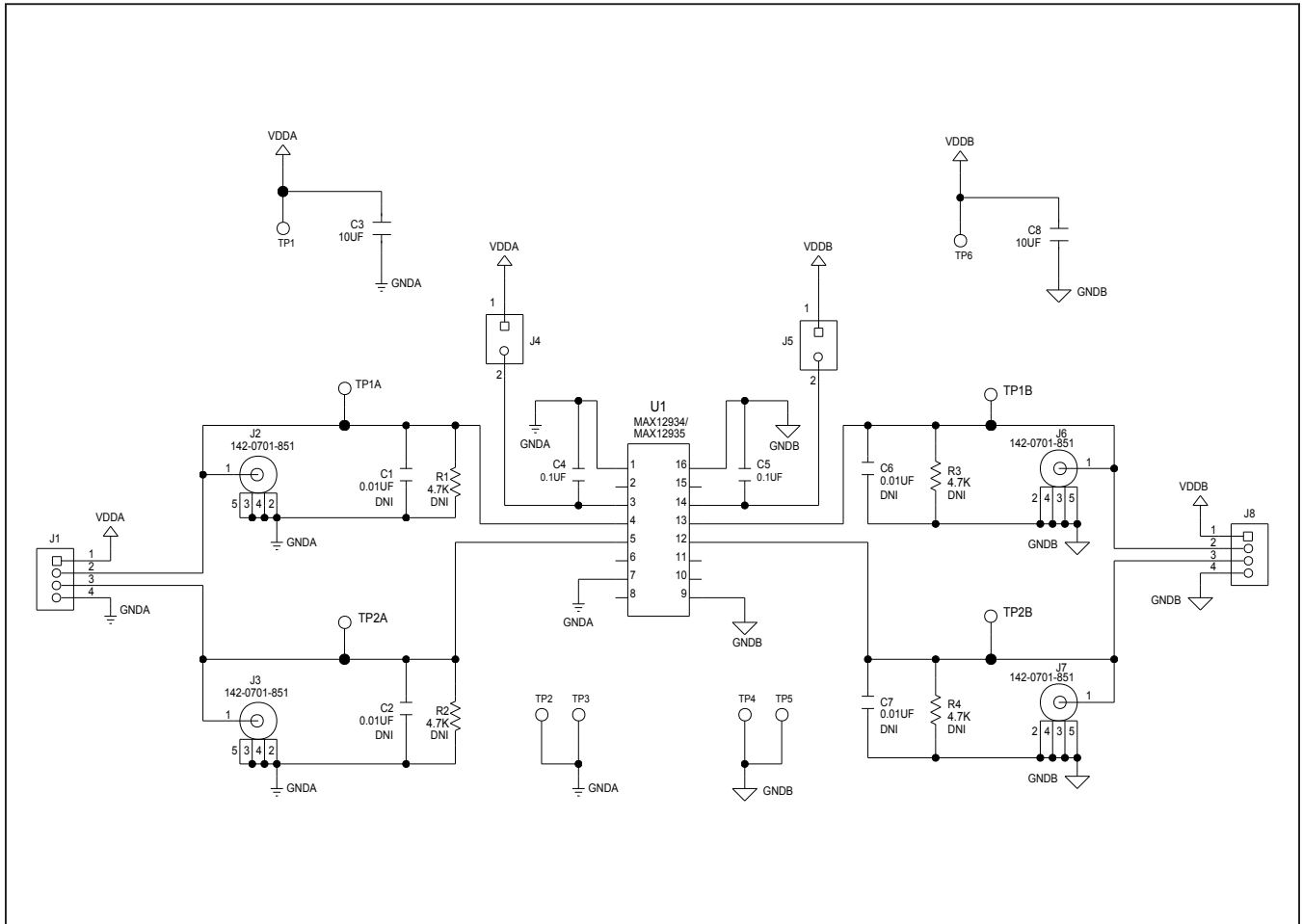

MAX1293XW EV Kit PCB Layout

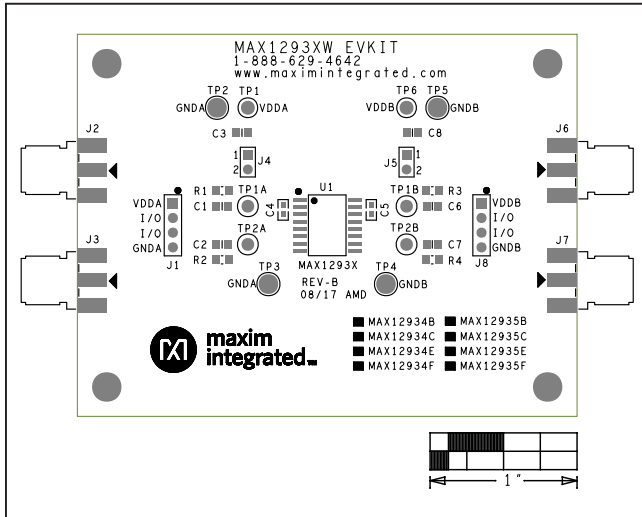

MAX1293XW EV Kit—Top Silkscreen

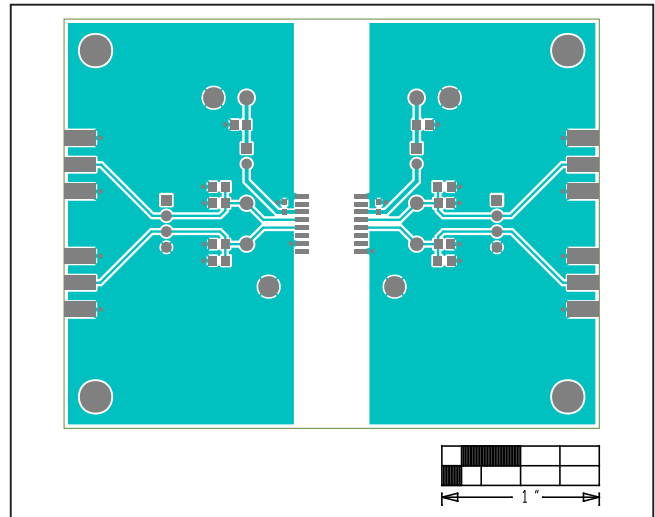

MAX1293XW EV Kit—Top

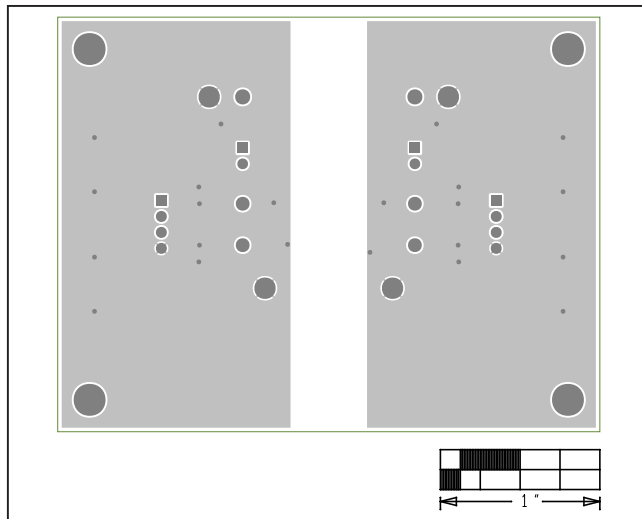

MAX1293XW EV Kit—Level 2 GND

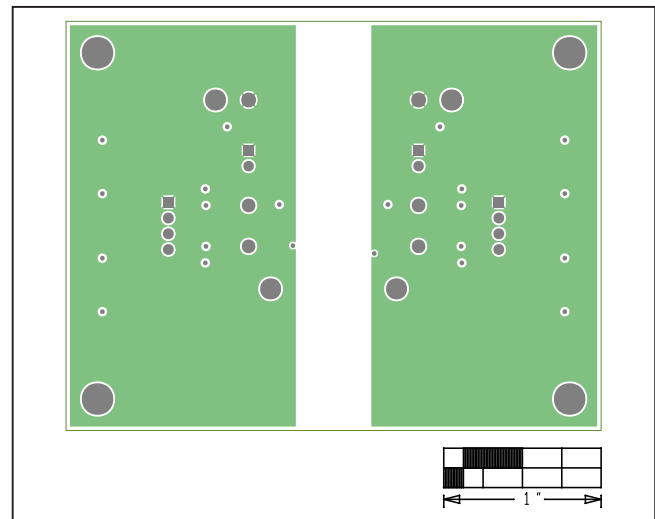

MAX1293XW EV Kit—Level 3 Power

MAX1293XW EV Kit PCB Layout (continued)

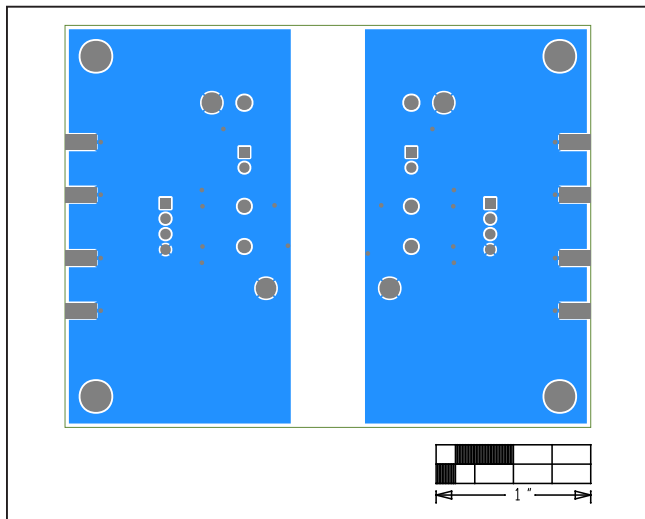

MAX1293XW EV Kit—Bottom