

## ±60V Fault-Protected LIN Transceivers

### General Description

The MAX13020/MAX13021 ±60V fault-protected low-power local interconnect network (LIN) transceivers are ideal for use in automotive network applications where high reliability is required. The devices provide the interface between the LIN master/slave protocol controller, and the physical bus described in the LIN 2.0 specification package and SAE J2602 specification. The devices are intended for in-vehicle subnetworks with a single master and multiple slaves.

The extended fault-protected voltage range of ±60V on the LIN bus line allows for use in +12V, +24V, and +42V automotive applications. The devices allow communication up to 20kbaud, and include slew-rate limited transmitters for enhanced electromagnetic emissions (EME) performance. The devices feature a low-power 4μA sleep mode and provide wake-up source detection.

The MAX13020 is a pin-to-pin replacement and is functionally compatible with the Philips TJA1020. The MAX13021 includes enhanced bus dominant clamping fault management for reduced quiescent current during LIN bus shorts to GND. The MAX13020/MAX13021 are available in the 8-pin SO package, and operate over the -40°C to +125°C automotive temperature range.

### Applications

- +12V/+42V Automotive
- +24V Heavy Truck and Bus

### Features

- ◆ MAX13020 is a Pin-to-Pin Upgrade for TJA1020
- ◆ ESD Protection
  - ±12kV Human Body Model (LIN)
  - ±4kV Contact Discharge (LIN, NWAKE, BAT)
- ◆ LIN 2.0/SAE J2602 Compatible
- ◆ Slew-Rate Limited Transmitter for Low Electromagnetic Emissions (EME)
- ◆ Robust Electromagnetic Immunity (EMI)
- ◆ Passive Behavior in Unpowered State
- ◆ TXD Dominant Timeout Function
- ◆ LIN Bus Dominant Management (MAX13021 Only)
- ◆ Input Levels Compatible with +3.3V and +5V Controllers
- ◆ Integrated 30kΩ Termination Resistor for Slave Applications
- ◆ Low 4μA Sleep Mode with Local and Remote Wake-Up Detection
- ◆ Wake-Up Source Recognition
- ◆ Thermal Shutdown

### Ordering Information

PART	LIN BUS DOMINANT MANAGEMENT	PIN-PACKAGE
MAX13020ASA+	—	8 SO
MAX13021ASA+	Yes	8 SO
MAX13021ASAV+	Yes	8 SO

**Note:** All devices are specified over the -40°C to +125°C automotive temperature range.

+Denotes a lead(Pb)-free/RoHS-compliant package.

### Typical Operating Circuit

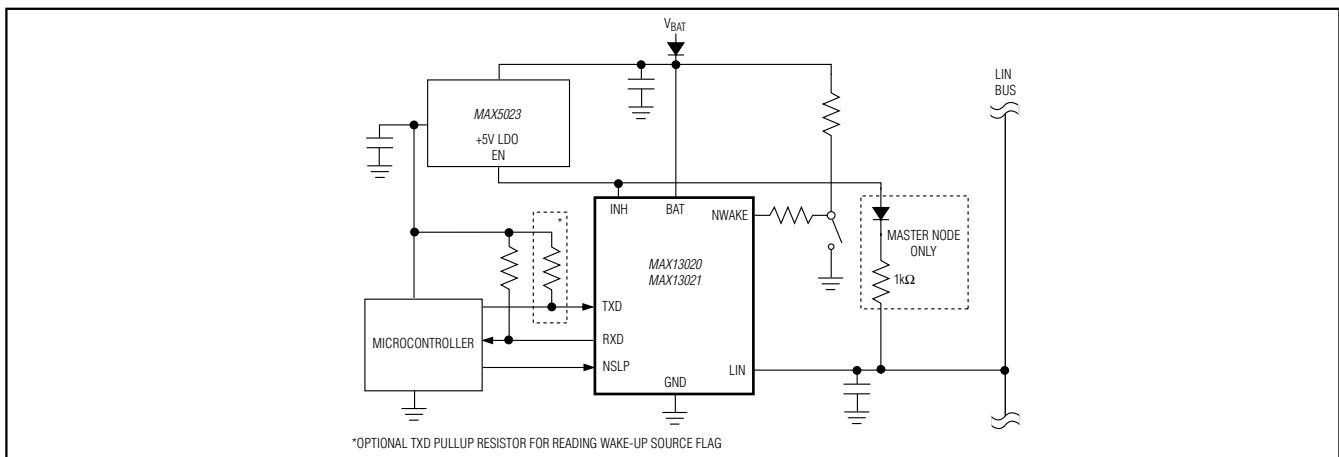

Pin Configuration appears at end of data sheet.

**For pricing, delivery, and ordering information, please contact Maxim Direct at 1-888-629-4642, or visit Maxim's website at [www.maximintegrated.com](http://www.maximintegrated.com).**

# MAX13020/MAX13021

## ±60V Fault-Protected LIN Transceivers

### ABSOLUTE MAXIMUM RATINGS

(All voltages referenced to GND, unless otherwise noted.  
Positive currents flow into the device.)

BAT	-0.3V to +40V
TXD, RXD, NSLP	-0.3V to +7V
LIN	0V to ±60V Continuous
LIN to BAT	-80V Continuous
NWAKE	-0.3V to +80V
NWAKE Current (NWAKE < -0.3V)	-15mA

INH	-0.3V to V <sub>BAT</sub> + 0.3V
INH Current	-50mA to +15mA
Continuous Power Dissipation	
8-Pin SO (derate 5.9mW/°C above +70°C)	471mW
Operating Temperature Range	-40°C to +125°C
Storage Temperature Range	-65°C to +150°C
Junction Temperature	+150°C
Lead Temperature (soldering, 10s)	+300°C
Soldering Temperature (reflow)	+260°C

Stresses beyond those listed under "Absolute Maximum Ratings" may cause permanent damage to the device. These are stress ratings only, and functional operation of the device at these or any other conditions beyond those indicated in the operational sections of the specifications is not implied. Exposure to absolute maximum rating conditions for extended periods may affect device reliability.

### ELECTRICAL CHARACTERISTICS

(V<sub>BAT</sub> = +5V to +38V, T<sub>A</sub> = -40°C to +125°C, unless otherwise noted. Typical values are at V<sub>BAT</sub> = +12V and T<sub>A</sub> = +25°C. Positive currents flow into the device.)

PARAMETER	SYMBOL	CONDITIONS	MIN	TYP	MAX	UNITS	
BAT Supply Voltage	V <sub>BAT</sub>	Operating range	5.0		38.0	V	
BAT Supply Current	I <sub>BAT</sub>	Sleep mode, V <sub>NWAKE</sub> = V <sub>BAT</sub> , V <sub>TXD</sub> = V <sub>NSLP</sub> = V <sub>GND</sub>	V <sub>BAT</sub> = +27V, V <sub>LIN</sub> = V <sub>BAT</sub>	1	4	8	μA
			V <sub>BAT</sub> = +38V, V <sub>LIN</sub> = V <sub>BAT</sub>			8	
		Standby mode, bus recessive, V <sub>BAT</sub> = +5V to +27V, V <sub>LIN</sub> = V <sub>INH</sub> = V <sub>NWAKE</sub> = V <sub>BAT</sub> , V <sub>TXD</sub> = V <sub>NSLP</sub> = V <sub>GND</sub>	100	650	1000		
		Standby mode, bus dominant, V <sub>BAT</sub> = +12V, V <sub>INH</sub> = V <sub>NWAKE</sub> = V <sub>BAT</sub> , V <sub>LIN</sub> = V <sub>TXD</sub> = V <sub>NSLP</sub> = V <sub>GND</sub>	300	1000	2000		
		Normal/low slope mode, bus recessive, V <sub>BAT</sub> = +5V to +27V, V <sub>LIN</sub> = V <sub>INH</sub> = V <sub>NWAKE</sub> = V <sub>BAT</sub> , V <sub>TXD</sub> = V <sub>NSLP</sub> = +5V	100	650	1000		
		Normal/low slope mode, bus dominant, no load, V <sub>BAT</sub> = V <sub>INH</sub> = V <sub>NWAKE</sub> = +12V, V <sub>TXD</sub> = V <sub>GND</sub> , V <sub>NSLP</sub> = +5V	1	4.5	8	mA	
		Sleep mode, bus dominant, V <sub>BAT</sub> = V <sub>NWAKE</sub> = +12V, V <sub>LIN</sub> = V <sub>TXD</sub> = V <sub>NSLP</sub> = V <sub>GND</sub>		90		μA	
		Fault mode, bus dominant (MAX13021), V <sub>INH</sub> = V <sub>NWAKE</sub> = V <sub>BAT</sub> , V <sub>LIN</sub> = V <sub>GND</sub> , V <sub>NSLP</sub> = +5V		30	60		
		Disable mode, bus dominant (MAX13021), V <sub>BAT</sub> = V <sub>INH</sub> = V <sub>NWAKE</sub> = +12V, V <sub>LIN</sub> = V <sub>GND</sub>		20	30		

# MAX13020/MAX13021

## ±60V Fault-Protected LIN Transceivers

### ELECTRICAL CHARACTERISTICS (continued)

( $V_{BAT} = +5V$  to  $+38V$ ,  $T_A = -40^{\circ}C$  to  $+125^{\circ}C$ , unless otherwise noted. Typical values are at  $V_{BAT} = +12V$  and  $T_A = +25^{\circ}C$ . Positive currents flow into the device.)

PARAMETER	SYMBOL	CONDITIONS	MIN	TYP	MAX	UNITS
<b>TRANSMITTER DATA INPUT (TXD)</b>						
High-Level Input Voltage	$V_{IH}$	Output recessive	2			V
Low-Level Input Voltage	$V_{IL}$	Output dominant			0.8	V
Pulldown Resistance	$R_{TXD}$		125	330	800	$k\Omega$
Low-Level Input Current	$I_{IL}$	$V_{TXD} = V_{GND}$	-5	0	+5	$\mu A$
Low-Level Output Current	$I_{OL}$	Standby mode, $V_{NWAKE} = V_{GND}$ , $V_{LIN} = V_{BAT}$ , $V_{TXD} = +0.4V$ , local wake-up request	1.5	6		mA
<b>RECEIVER DATA OUTPUT (RXD)</b>						
Low-Level Output Current	$I_{OL}$	$V_{LIN} = V_{GND}$ , $V_{RXD} = +0.4V$	1.2	4.1		mA
High-Level Leakage Current	$I_{LH}$	Normal/low slope mode, $V_{LIN} = V_{BAT}$ , $V_{RXD} = +5V$	-5	0	+5	$\mu A$
<b>NSLP INPUT</b>						
High-Level Input Voltage	$V_{IH}$		2			V
Low-Level Input Voltage	$V_{IL}$				0.8	V
Pulldown Resistance	$R_{NSLP}$	$V_{NSLP} = +5V$	125	330	800	$k\Omega$
Low-Level Input Current	$I_{IL}$	$V_{NSLP} = V_{GND}$	-5	0	+5	$\mu A$
<b>NWAKE INPUT</b>						
High-Level Input Voltage	$V_{IH}$		$V_{BAT} - 1.0$			V
Low-Level Input Voltage	$V_{IL}$				$V_{BAT} - 3.3$	V
NWAKE Pullup Current	$I_{IL}$	$V_{NWAKE} = V_{GND}$	-30	-10	-3	$\mu A$
High-Level Leakage Current	$I_{LH}$	$V_{NWAKE} = +38V$ , $V_{BAT} = +38V$	-5	0	+5	$\mu A$
<b>INH OUTPUT</b>						
Switch On-Resistance Between BAT and INH	$R_{SW}$	Standby, normal/low slope modes, $I_{INH} = -15mA$ , $V_{BAT} = +12V$		22	50	$\Omega$
High-Level Leakage Current	$I_{LH}$	Sleep mode, $V_{NWAKE} = +38V$ , $V_{BAT} = +38V$	-5	0	+5	$\mu A$
<b>LIN BUS I/O</b>						
LIN Recessive Output Voltage	$V_{O(RECES)}$	$V_{TXD} = +5V$ , $I_{LIN} = -1\mu A$	$V_{BAT} - 1.0V$			V
LIN Dominant Output Voltage	$V_{O(DOM)}$	Normal/low slope mode, $V_{TXD} = V_{GND}$ , $V_{BAT} = +7V$ to $+27V$ , $R_{TERM} = 500\Omega$ to BAT		$0.2 \times V_{BAT}$		V

# MAX13020/MAX13021

## ±60V Fault-Protected LIN Transceivers

### ELECTRICAL CHARACTERISTICS (continued)

(V<sub>BAT</sub> = +5V to +38V, T<sub>A</sub> = -40°C to +125°C, unless otherwise noted. Typical values are at V<sub>BAT</sub> = +12V and T<sub>A</sub> = +25°C. Positive currents flow into the device.)

PARAMETER	SYMBOL	CONDITIONS	MIN	TYP	MAX	UNITS
High-Level Leakage Current	I <sub>LH</sub>	V <sub>LIN</sub> = V <sub>BAT</sub> , V <sub>TXD</sub> = +5V	-5	0	+5	μA
Device Leakage Current, V <sub>BAT</sub> Disconnected	I <sub>L(BAT)</sub>	V <sub>BAT</sub> = V <sub>GND</sub> , V <sub>LIN</sub> = +18V	-5	0	+5	μA
Device Leakage Current, GND Disconnected	I <sub>L(GND)</sub>	V <sub>BAT</sub> = V <sub>GND</sub> , V <sub>LIN</sub> = -18V	-100		0	μA
LIN Current After Short Detection	I <sub>IL(FAULT)</sub>	Fault mode, disable mode (MAX13021) V <sub>LIN</sub> = V <sub>GND</sub>	-10		-2	μA
Short-Circuit Recovery Threshold Voltage	V <sub>th(RECOVERY)</sub>	Fault mode, disable mode (MAX13021)	V <sub>BAT</sub> - 2.5		V <sub>BAT</sub> - 0.9	V
LIN Pullup Current	I <sub>IL</sub>	Sleep mode, V <sub>LIN</sub> = V <sub>GND</sub> , V <sub>NSLP</sub> = V <sub>GND</sub>	-10		-2	μA
Slave Termination Resistance to V <sub>BAT</sub>	R <sub>SLAVE</sub>	Standby, normal/low slope modes, V <sub>LIN</sub> = V <sub>GND</sub> , V <sub>BAT</sub> = +12V	20	30	47	kΩ
Short-Circuit Output Current	I <sub>O(SC)</sub>	V <sub>LIN</sub> = V <sub>BAT</sub> = +12V, V <sub>TXD</sub> = V <sub>GND</sub> , t < t <sub>DOM</sub>	27	40	60	mA
		V <sub>LIN</sub> = +12V, V <sub>BAT</sub> = +27V, V <sub>TXD</sub> = V <sub>GND</sub> , t < t <sub>DOM</sub> (Note 1)	45	70	100	
		V <sub>BAT</sub> = +12V, V <sub>LIN</sub> = +60V, V <sub>TXD</sub> = V <sub>GND</sub> , t < t <sub>DOM</sub>		45		
Receiver Dominant State	V <sub>th(DOM)</sub>	V <sub>BAT</sub> = +7V to +38V			0.4 x V <sub>BAT</sub>	V
Receiver Recessive State	V <sub>th(REC)</sub>	V <sub>BAT</sub> = +7V to +38V			0.6 x V <sub>BAT</sub>	V
Receiver-Threshold Center Voltage	V <sub>th(CENTER)</sub>	V <sub>BAT</sub> = +7V to +38V	0.475 x V <sub>BAT</sub>	0.5 x V <sub>BAT</sub>	0.525 x V <sub>BAT</sub>	V
Receiver-Threshold Hysteresis Voltage	V <sub>th(HYS)</sub>	V <sub>BAT</sub> = +7V to +38V	0.145 x V <sub>BAT</sub>	0.16 x V <sub>BAT</sub>	0.175 x V <sub>BAT</sub>	V
Thermal-Shutdown Threshold	T <sub>SHDN</sub>			+165		°C
Thermal-Shutdown Hysteresis				10		°C
<b>ESD PROTECTION</b>						
Human Body Model		LIN		±12		kV
Contact Discharge IEC61000-4-2		LIN, NWAKE, BAT (tested to IBEE test setup) C <sub>1</sub> = 100nF on V <sub>BAT</sub> , C <sub>2</sub> = 220pF on LIN, R = 33kΩ on NWAKE		±4		kV

# MAX13020/MAX13021

## ±60V Fault-Protected LIN Transceivers

### TIMING CHARACTERISTICS

( $V_{BAT} = +5V$  to  $+38V$ ,  $T_A = -40^\circ C$  to  $+125^\circ C$ , unless otherwise noted. Typical values are at  $V_{BAT} = +12V$  and  $T_A = +25^\circ C$ . Positive currents flow into the device.)

PARAMETER	SYMBOL	CONDITIONS	MIN	TYP	MAX	UNITS
LIN Duty Factor 1 $D1 = t_{BUS(REC)(MAX)} / (2 \times t_{BIT})$	D1	$V_{BAT} = +7V$ to $+18V$ , $V_{th(REC)(MAX)} = 0.744 \times V_{BAT}$ , $V_{th(DOM)(MAX)} = 0.581 \times V_{BAT}$ , $t_{BIT} = 50\mu s$ (Figure 4, Note 2)	0.396			—
LIN Duty Factor 2 $D2 = t_{BUS(REC)(MAX)} / (2 \times t_{BIT})$	D2	$V_{BAT} = +8V$ to $+18V$ , $V_{th(REC)(MIN)} = 0.422 \times V_{BAT}$ , $V_{th(DOM)(MIN)} = 0.284 \times V_{BAT}$ , $t_{BIT} = 50\mu s$ (Figure 4, Note 2)			0.581	—
LIN Duty Factor 3 $D3 = t_{BUS(REC)(MAX)} / (2 \times t_{BIT})$	D3	$V_{BAT} = +7V$ to $+18V$ , $V_{th(REC)(MAX)} = 0.778 \times V_{BAT}$ , $V_{th(DOM)(MAX)} = 0.616 \times V_{BAT}$ , $t_{BIT} = 96\mu s$ (Figure 4, Note 2)	0.417			—
LIN Duty Factor 4 $D4 = t_{BUS(REC)(MAX)} / (2 \times t_{BIT})$	D4	$V_{th(REC)(MIN)} = 0.389 \times V_{BAT}$ , $V_{th(DOM)(MIN)} = 0.251 \times V_{BAT}$ , $V_{BAT} = +8V$ to $+18V$ , $t_{BIT} = 96\mu s$ (Figure 4, Note 2)			0.590	—
Propagation Delay of Receiving Node	$t_{p(RX)}$	$V_{BAT} = +7V$ to $+18V$ , $C_{RXD} = 20pF$ (Figure 4)			6	$\mu s$
Receiver Propagation Delay Symmetry	$t_{p(RX)(SYM)}$	Rising edge with respect to falling edge, $V_{BAT} = +7V$ to $+18V$ , $C_{RXD} = 20pF$ , $R_{RXD} = 1k\Omega$	-2		+2	$\mu s$
Continuously Dominant-Clamped LIN Bus Detection Time	$t_{LIN(DOM)(DET)}$	Normal/low slope mode (MAX13021), $V_{LIN} = V_{GND}$	40	80	160	ms
Continuously Dominant-Clamped LIN Bus Recovery Time	$t_{LIN(DOM)(REC)}$	Normal/low slope mode (MAX13021), $V_{LIN} = V_{GND}$	0.5	1	2	ms
Dominant Time for Wake-Up of the LIN Transceiver	$t_{BUS}$	Sleep mode (Figure 3)	30	70	150	$\mu s$
TXD Permanent Dominant Disable Time	$t_{TXD(DOM)(DIS)}$	Normal/low slope mode, $V_{TXD} = V_{GND}$	20		80	ms
Dominant Time for Wake-Up Through NWAKE	$t_{NWAKE}$	Sleep mode	7	20	50	$\mu s$

# MAX13020/MAX13021

## ±60V Fault-Protected LIN Transceivers

### TIMING CHARACTERISTICS (continued)

( $V_{BAT} = +5V$  to  $+38V$ ,  $T_A = -40^\circ C$  to  $+125^\circ C$ , unless otherwise noted. Typical values are at  $V_{BAT} = +12V$  and  $T_A = +25^\circ C$ . Positive currents flow into the device.)

PARAMETER	SYMBOL	CONDITIONS	MIN	TYP	MAX	UNITS
Mode Change Time from Sleep/Standby Mode to Normal/Low Slope Mode	$t_{GOTONORM}$	(Note 3)	2	5	10	$\mu s$
Mode Change Time from Normal/Low Slope Mode to Sleep Mode	$t_{GOTOSLEEP}$	(Note 4)	2	5	10	$\mu s$

**Note 1:** Guaranteed by design for  $V_{BAT} = V_{LIN} = +27V$ .

**Note 2:** Selected bit time,  $t_{BIT} = 50\mu s$  or  $96\mu s$  (20kbaud or 10.4kbaud). Bus load conditions ( $C_{BUS} / R_{BUS}$ ):  $1nF/1k\Omega$ ,  $6.8nF/660\Omega$ ,  $10nF/500\Omega$ .

**Note 3:**  $t_{GOTONORM}$  is measured from rising edge of  $N_{SLP}$  to RXD active.

**Note 4:**  $t_{GOTOSLEEP}$  is measured from falling edge of  $N_{SLP}$  to RXD high impedance.

### Typical Operating Characteristics

( $V_{BAT} = +12V$  and  $T_A = +25^\circ C$ , unless otherwise noted.)

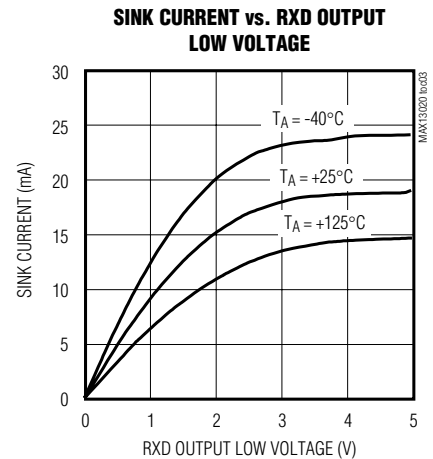
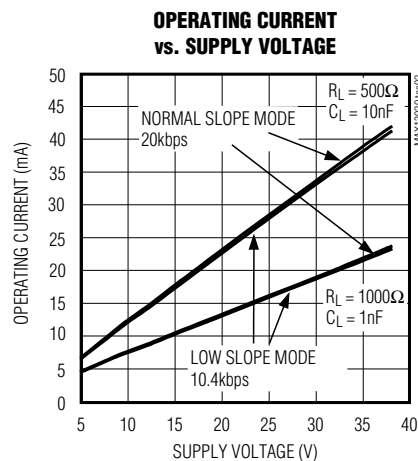
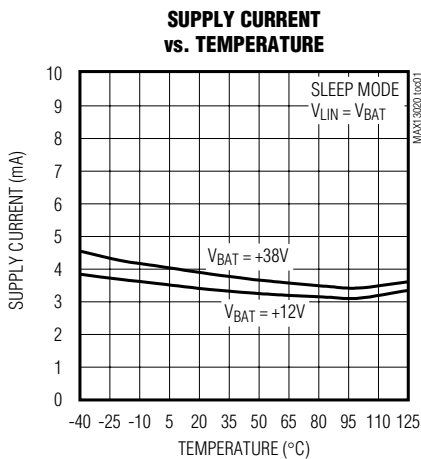

# MAX13020/MAX13021

## ±60V Fault-Protected LIN Transceivers

### Typical Operating Characteristics (continued)

( $V_{BAT} = +12V$  and  $T_A = +25^\circ C$ , unless otherwise noted.)

**SINK CURRENT vs. TXD PULLDOWN OUTPUT VOLTAGE**

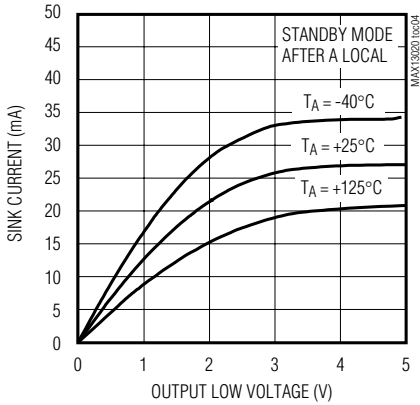

**INH ON-RESISTANCE vs. TEMPERATURE**

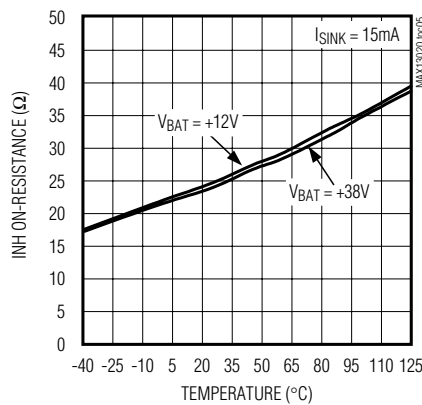

**IBAT FAULT CURRENT vs. TEMPERATURE**

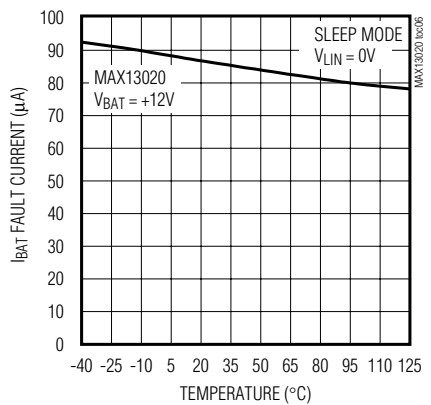

**LIN OUTPUT SPECTRUM**

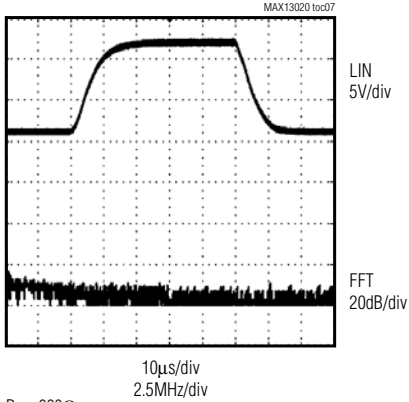

$R_L = 660\Omega$   
 $C_L = 6.8nF$   
 NORMAL SCOPE MODE  
 20kbps

**LIN OUTPUT SPECTRUM**

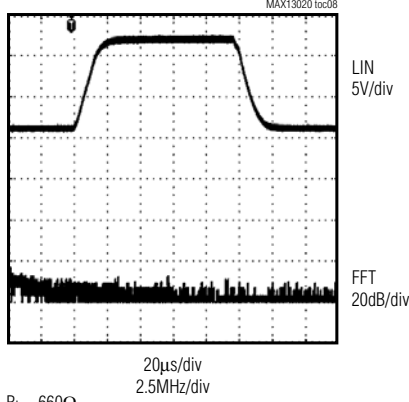

$R_L = 660\Omega$   
 $C_L = 6.8nF$   
 LOW SCOPE MODE  
 10.4kbps

**LIN TRANSMITTING NORMAL SLOPE MODE**

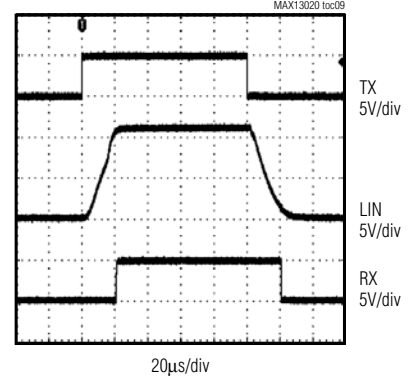

$R_L = 1k\Omega$   
 $C_L = 1nF$   
 NORMAL SCOPE MODE  
 20kbps

# MAX13020/MAX13021

## ±60V Fault-Protected LIN Transceivers

### Typical Operating Characteristics (continued)

( $V_{BAT} = +12V$  and  $T_A = +25^\circ C$ , unless otherwise noted.)

**LIN TRANSMITTING NORMAL SLOPE MODE**

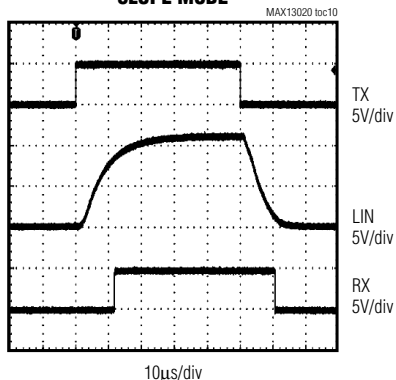

$R_L = 660k\Omega$   
 $C_L = 6.8nF$   
 NORMAL SCOPE MODE  
 20kbps

**LIN TRANSMITTING NORMAL SLOPE MODE**

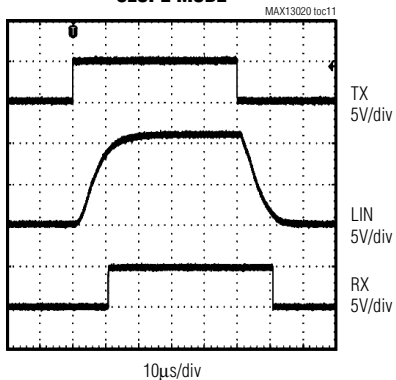

$R_L = 500k\Omega$   
 $C_L = 10nF$   
 NORMAL SCOPE MODE  
 20kbps

**LIN TRANSMITTING LOW SLOPE MODE**

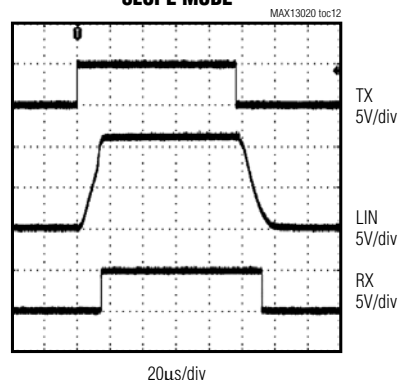

$R_L = 1k\Omega$   
 $C_L = 1nF$   
 LOW SCOPE MODE  
 10.4kbps

**LIN TRANSMITTING LOW SLOPE MODE**

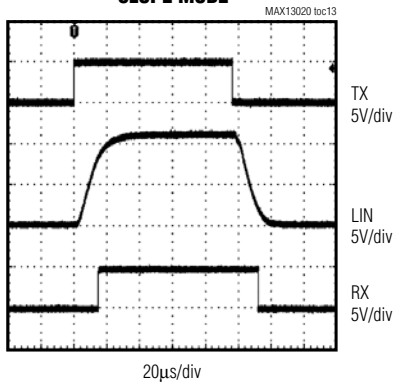

$R_L = 660k\Omega$   
 $C_L = 6.8nF$   
 LOW SCOPE MODE  
 10.4kbps

**LIN TRANSMITTING LOW SLOPE MODE**

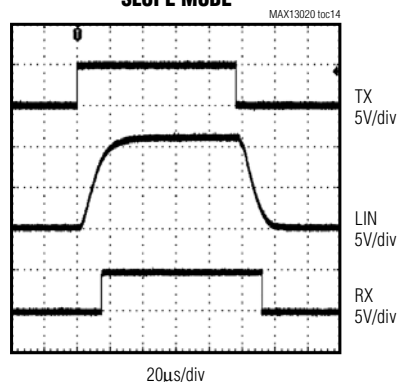

$R_L = 500k\Omega$   
 $C_L = 10nF$   
 LOW SCOPE MODE  
 10.4kbps



# MAX13020/MAX13021

## ±60V Fault-Protected LIN Transceivers

### Pin Description

PIN	NAME	FUNCTION
1	RXD	Data Receive Output, Open Drain. RXD is logic-low when the LIN bus is dominant. RXD is active low after a wake-up event from sleep mode.
2	NSLP	Sleep Input. Drive NSLP logic-high or logic-low to control the operating mode. (See Table 1 and Figures 1, 2)
3	NWAKE	Local Wake-Up Input. Present a falling edge on NWAKE to generate a local wake-up event. Connect NWAKE to BAT with a 5kΩ resistor if local wake-up is not required.
4	TXD	Data Transmit Input, CMOS Compatible. Drive TXD logic-low to force the LIN bus to a dominant state in normal/low slope mode.
5	GND	Ground
6	LIN	LIN Bus I/O. LIN is terminated with an internal 30kΩ resistor in normal slope, low slope, and standby modes.
7	BAT	Battery Voltage Input. Bypass BAT to ground with a 0.1μF ceramic capacitor as close to the device as possible.
8	INH	Inhibit Output. INH is active high in standby and normal/low slope modes. (See Table 1)

### Detailed Description

The MAX13020/MAX13021 ±60V fault-protected low-power local interconnect network (LIN) transceivers are ideal for use in automotive network applications where high reliability is required. The devices provide the interface between the LIN master/slave protocol controller and the physical bus described in the LIN 2.0 specification package and SAE J2602 specification. The devices are intended for in-vehicle subnetworks with a single master and multiple slaves.

The extended fault-protected voltage range of ±60V on the LIN bus line allows for use in +12V, +24V, and +42V automotive applications. The devices allow communication up to 20kbaud, and include slew-rate limited transmitters for enhanced electromagnetic emissions (EME) performance. The devices feature a low-power 4μA sleep mode and provide wake-up source detection.

The MAX13020 is a pin-to-pin replacement and is functionally compatible with the Philips TJA1020. The MAX13021 includes enhanced bus dominant clamping fault-management for reduced quiescent current during LIN bus shorts to GND.

### Operating Modes

The MAX13020/MAX13021 provide two different transmitting modes, an intermediate standby mode and a low-power sleep mode. Normal slope mode allows full-speed communication at 20kbaud with a slew-limited transmitter to reduce EME. Low slope mode permits communication up to 10.4kbaud, and provides addi-

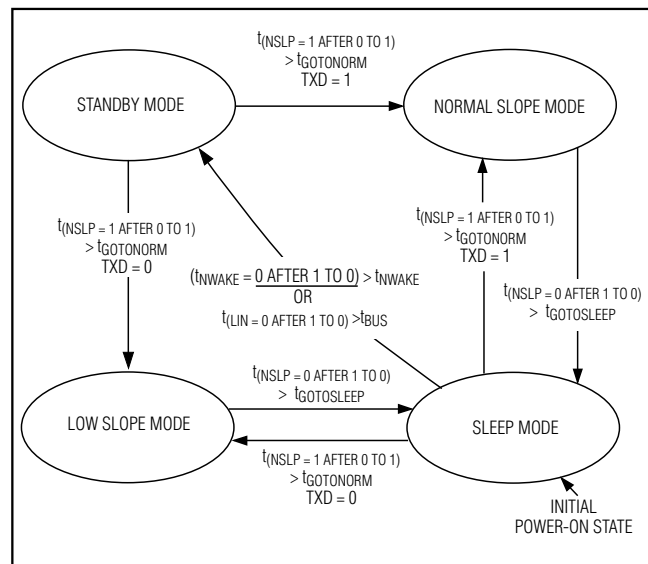

Figure 1. MAX13020 Operating Modes

tional slew-rate limiting to further reduce EME. The transmitting operating mode is selected by the logic state of NSLP and TXD (Table 1). To enter normal slope mode or low slope mode, drive TXD logic-high or logic-low, then drive NSLP logic-high for longer than tGOTONORM. The MAX13021 features two additional operating modes to reduce current consumption during LIN bus shorts to GND.

On initial power-up, the device enters sleep mode.

# MAX13020/MAX13021

## ±60V Fault-Protected LIN Transceivers

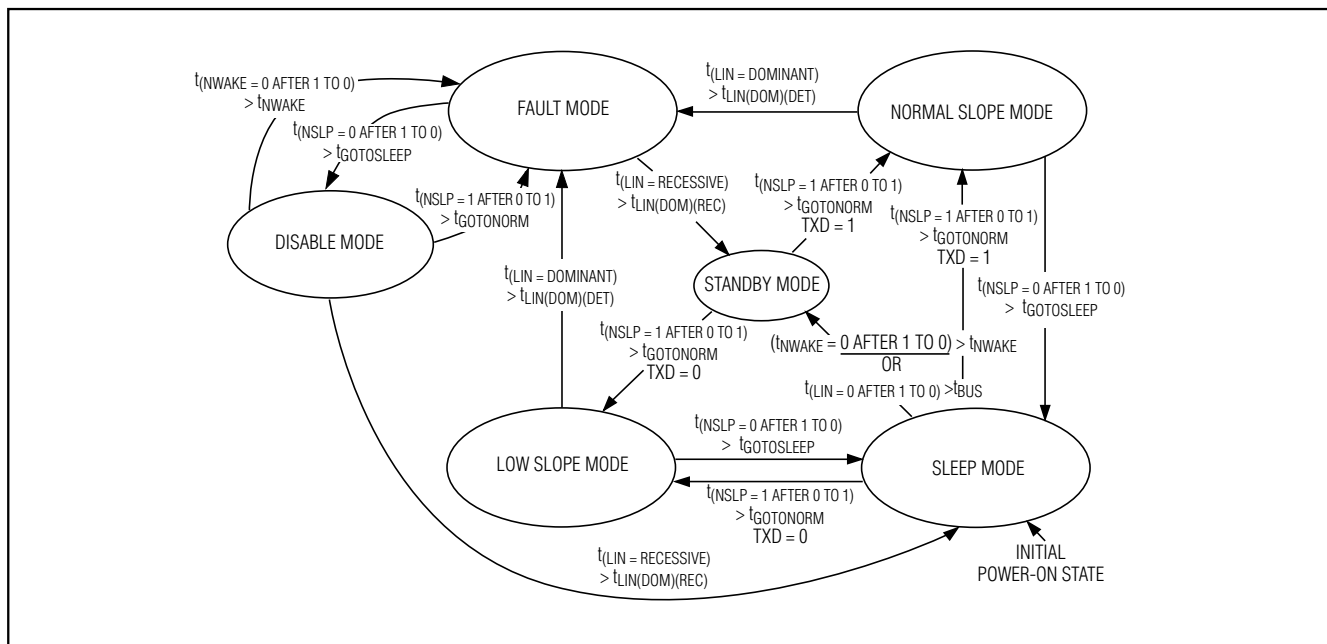

Figure 2. MAX13021 Operating Modes

### Sleep Mode

Sleep mode is the lowest power operating mode and is the default state after power is applied to BAT. In sleep mode, the MAX13020/MAX13021 disable the LIN transmitter and receiver to reduce power consumption. RXD and INH are high impedance. The internal slave termination resistor between LIN and BAT is disabled, and only a weak pullup from LIN to BAT is enabled. While in sleep mode, the MAX13020/MAX13021 transition to standby mode when a local or remote wake-up event is detected. For applications with a continuously powered microprocessor, drive NSLP logic-high for longer than  $t_{GOTONORM}$  to force the MAX13020/MAX13021 directly into normal slope mode if TXD is logic-high, and low slope mode if TXD is logic-low. From normal slope or low slope mode, drive NSLP logic-low for longer than  $t_{GOTOSLEEP}$  to force the MAX13020/MAX13021 into sleep mode.

### Standby Mode

In standby mode, the LIN transmitter and receiver are disabled, the internal slave termination resistor between LIN and BAT is enabled, and the INH output is pulled high. The MAX13020/MAX13021 transition to standby mode from sleep mode when a wake-up event is detected. From standby mode, drive TXD logic-high or logic-low, then drive NSLP logic-high for longer than  $t_{GOTONORM}$  to transition to normal slope or low slope

mode. In standby mode, RXD is driven logic-low to transmit the wake-up interrupt flag to a microcontroller. The wake-up source flag is presented on TXD as a strong pull-down in the case of a local wake-up. In the case of a remote wake-up, TXD is pulled low by the internal 330kΩ resistor only. The wake-up interrupt and wake-up source flag are cleared when the MAX13020/MAX13021 transition to normal slope mode or low slope mode.

### Normal Slope Mode

In normal slope mode, the MAX13020/MAX13021 provide the physical layer interface to a LIN bus through RXD and TXD. INH is pulled high and the internal slave termination resistance from LIN to BAT is enabled. Data presented on TXD is transmitted on the LIN bus with a controlled slew rate to limit EME. Drive TXD logic-low to assert a dominant state on LIN. The LIN bus state is presented on the open-drain output RXD. A dominant LIN state produces a logic-low on RXD. From standby or sleep mode, drive TXD logic-high, then drive NSLP logic-high for longer than  $t_{GOTONORM}$  to enter normal slope mode. Drive NSLP logic-low for longer than  $t_{GOTOSLEEP}$  to force the device into sleep mode from normal slope mode.

# MAX13020/MAX13021

## ±60V Fault-Protected LIN Transceivers

### Low Slope Mode

Low slope mode is identical to normal slope mode, with the exception of the LIN transmitter. In low slope mode, the transmitter slew-rate is further limited for improved EME performance. Maximum data rate is limited to 10.4kbaud due to the increased slew-rate limiting of the LIN transmitter. From standby or sleep mode, drive TXD logic-low, then drive NSLP logic-high for longer than tGOTONORM to enter low slope mode. Drive NSLP logic-low for longer than tGOTOSLEEP to force the device into sleep mode from low slope mode.

### LIN Bus Dominant Management (MAX13021)

The MAX13021 provides two additional states to implement reduced current consumption during a LIN-to-GND short condition. When the MAX13021 detects a dominant-clamped fault on LIN, the device disables the transmitter and enters a low-power fail-safe mode. The receiver is disabled and a low-power comparator is enabled to monitor the LIN bus. When a recessive state is detected on LIN, the device exits fault mode and returns to standby mode.

### Fault Mode (MAX13021)

The device enters fault mode from normal slope or low slope mode when a dominant state is detected on LIN for longer than tLIN(DOM)(DET). In fault mode, the slave

termination resistor from LIN to BAT is disconnected, and the LIN transmitter and receiver are disabled to reduce power consumption. INH output remains pulled high. A low-power comparator is enabled to monitor the LIN bus. Fault mode is cleared, and the MAX13021 enters standby mode when a recessive state is detected on LIN for longer than tLIN(DOM)(REC).

### Disable Mode (MAX13021)

The MAX13021 enters disable mode from fault mode after NSLP is driven logic-low for longer than tGOTOSLEEP. The INH output is high impedance in disable mode to reduce current consumption. The LIN transmitter and receiver are disabled, and the slave termination resistor from LIN to BAT is disconnected. A low-power comparator is enabled to monitor the LIN bus. The MAX13021 enters fault mode when NSLP is driven logic-high for longer than tGOTONORM. The device enters sleep mode if a recessive state is detected on LIN for longer than tLIN(DOM)(REC).

### Local and Remote Wake-Up Events

The MAX13020/MAX13021 recognize local and remote wake-up events from sleep mode. The MAX13021 also recognizes local wake-up events from disable mode. A local wake-up event is detected when NWAKE is held at logic-low for longer than tGOTONORM after a falling edge. NWAKE is internally pulled up to BAT with a

**Table 1. Operating Modes**

MODE	NSLP	TXD PULLDOWN	RXD	INH	TRANSMITTER	RECEIVER	COMMENTS
SLEEP	0	330kΩ	High-Z	High-Z	Disabled	Disabled	No wake-up events detected
STANDBY	0	330kΩ or strong pulldown	0	1	Disabled	Disabled	Wake-up detected from sleep mode. TXD indicates wake-up source. (Note 1)
NORMAL SLOPE	1	330kΩ	LIN	1	Normal slope	Enabled	(Notes 2, 3, 4)
LOW SLOPE	1	330kΩ	LIN	1	Low slope	Enabled	(Notes 2, 3, 5)
FAULT*	1	330kΩ	LIN	1	Disabled	Low power	—
DISABLE*	0	330kΩ	LIN	High-Z	Disabled	Low power	—

\*MAX13021 only.

High-Z = High impedance.

**Note 1:** Standby mode is entered automatically after a local or remote wake-up event from sleep mode. INH and the 30kΩ termination resistor on LIN are enabled.

**Note 2:** The internal wake-up source flag on TXD is cleared upon entering normal slope or low slope mode.

**Note 3:** The internal wake-up interrupt flag on RXD is cleared upon entering normal slope or low slope mode.

**Note 4:** Drive NSLP high for longer than tGOTONORM with TXD logic-high to enter normal slope mode.

**Note 5:** Drive NSLP high for longer than tGOTONORM with TXD logic-low to enter low slope mode.

# MAX13020/MAX13021

## ±60V Fault-Protected LIN Transceivers

10µA pullup. In applications where local wake-up capability is not required, connect NWAKE to BAT. For improved EMI performance, connect NWAKE to BAT through a 5kΩ resistance.

A remote wake-up event is generated when a recessive-dominant-recessive sequence is detected on LIN. The dominant state must be asserted longer than  $t_{BUS}$  to generate a remote wake-up (Figure 3).

### Wake-Up Source Recognition

When a wake-up event is detected, the MAX13020/MAX13021 enter standby mode and present the wake-up interrupt on RXD as a logic-low. The wake-up source flag is presented on TXD as a strong pulldown in the case of a local wake-up. In the case of a remote wake-up, TXD is pulled low by the internal 330kΩ resistor only. To read the wake-up source flag, pull TXD high with an external pullup resistor (see *Reading the Wake-Up Source Flag* section.) The wake-up interrupt and wake-up source flag are cleared when the MAX13020/MAX13021 transition to normal slope mode or low slope mode. The thermal-shutdown circuit forces the driver outputs into high-impedance state if the die temperature exceeds +160°C. Normal operation resumes when the die temperature cools to +140°C.

### Fail-Safe Features

The MAX13020/MAX13021 include a number of fail-safe features to handle fault conditions. Internal pull-downs are provided on control inputs TXD and NSLP to force the device into a known state in the event that these inputs are disconnected.

### LIN Short-Circuit Protection

The LIN transmitter is current-limited to prevent damage from LIN-to-BAT shorts.

### TXD Dominant Timeout

If TXD is shorted to GND or is otherwise held low, the resulting dominant LIN state blocks traffic on the LIN bus. In normal slope and low slope modes, the LIN transmitter is disabled if TXD is held at logic-low for longer than  $t_{TXD(DOM)}(DIS)$ . The transmitter is re-enabled on the next rising edge on TXD.

### Loss of Power

If BAT or GND are disconnected, interrupting power to the MAX13020/MAX13021, LIN remains high impedance to avoid loading the LIN bus. Additionally, RXD is

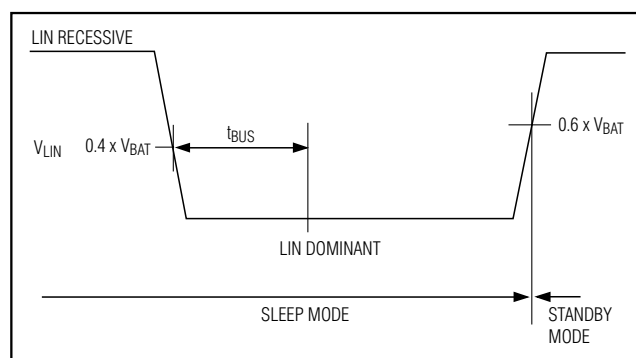

Figure 3. Remote Wake-Up Timing

high impedance when BAT is disconnected, preventing current flow from a connected microcontroller.

### LIN Bus Dominant Management (MAX13021)

The MAX13021 provides LIN bus dominant management protection to reduce current consumption during a LIN-to-GND short condition. When the LIN-to-GND short is cleared, and a recessive LIN state is detected, the MAX13021 returns to standby or sleep mode.

### ESD Protection

As with all Maxim devices, ESD-protection structures are incorporated on all pins to protect against ESDs encountered during handling and assembly. The LIN, NWAKE, and BAT pins are protected up to ±4kV as measured by the IEC61000-4-4 Contact Discharge Model. LIN is protected to ±12kV Human Body Model. Protection structures prevent damage caused by ESD events in all operating modes and when the device is unpowered.

### ESD Test Conditions

ESD performance depends on a variety of conditions. Contact Maxim for a reliability report documenting test setup, methodology, and results.

## Applications Information

### Master LIN Nodes

Configure the MAX13020/MAX13021 as a master LIN node by connecting a 1kΩ resistor from LIN to INH with a blocking diode (see the *Typical Operating Circuit*.) INH is held at a logic-high level in normal slope, low slope, standby, and fault (MAX13021) modes. INH is high impedance in sleep mode and disable mode (MAX13021) to reduce power consumption.

# MAX13020/MAX13021

## ±60V Fault-Protected LIN Transceivers

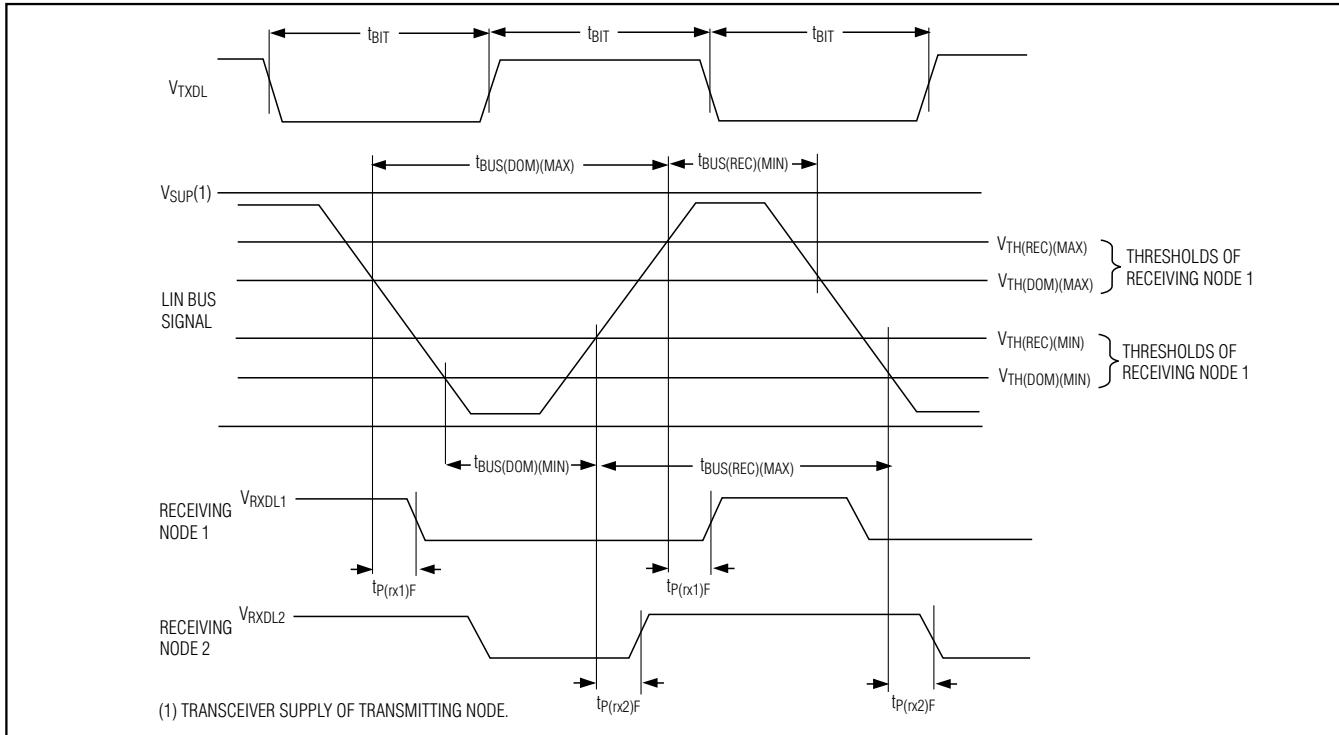

Figure 4. LIN Waveform Definition

### Reading the Wake-Up Source Flag

When a wake-up event is detected in sleep mode, the MAX13020/MAX13021 transition to standby mode and present the wake-up source flag on TXD as a strong pulldown in the case of a local wake-up. In the case of a remote wake-up event, TXD is pulled to ground only by an internal resistor. The wake-up source flag can be determined by connecting a pullup resistor to TXD. Choose the external pullup resistor such that TXD is a logic-high when a remote wake-up occurs, and when a local wake-up occurs and the strong pulldown drives TXD low.

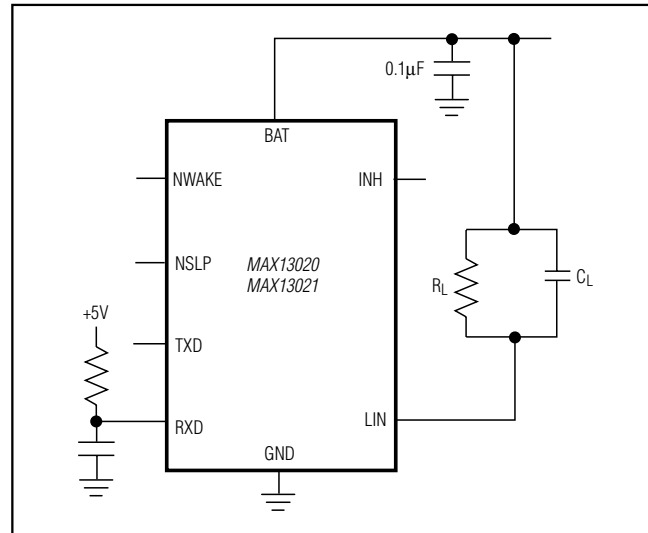
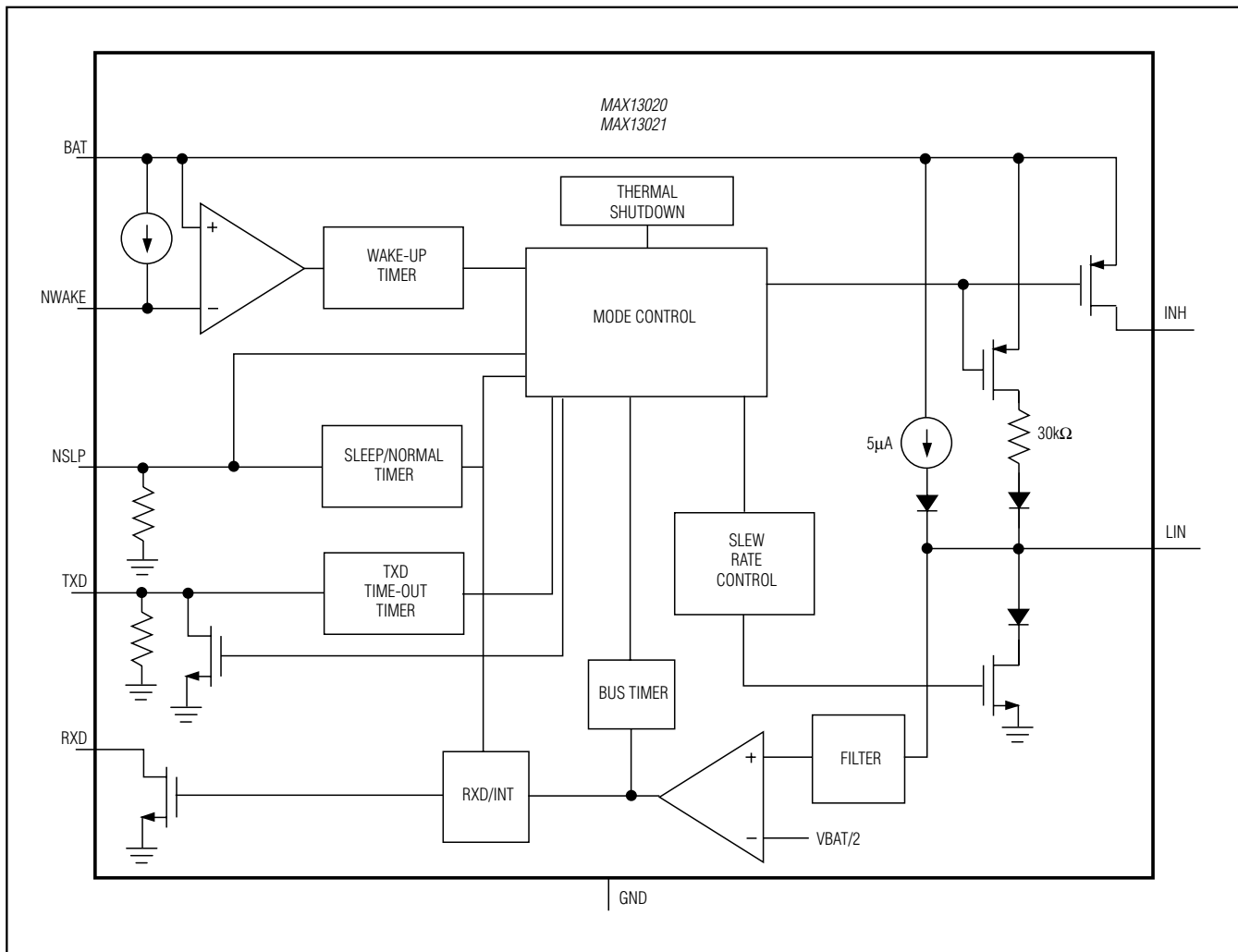

Figure 5. Test Circuit for AC Characteristics

# MAX13020/MAX13021

## ±60V Fault-Protected LIN Transceivers

### Functional Diagram



# MAX13020/MAX13021

## ±60V Fault-Protected LIN Transceivers

### Pin Configuration

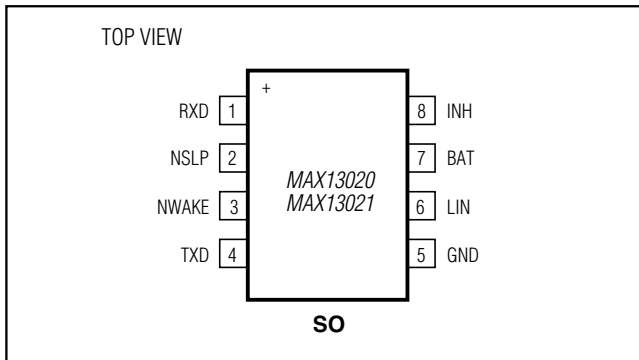

### Chip Information

PROCESS: BICMOS

### Package Information

For the latest package outline information and land patterns (footprints), go to [www.maximintegrated.com/packages](http://www.maximintegrated.com/packages). Note that a "+", "#", or "-" in the package code indicates RoHS status only. Package drawings may show a different suffix character, but the drawing pertains to the package regardless of RoHS status.

PACKAGE TYPE	PACKAGE CODE	OUTLINE NO.	LAND PATTERN NO.
8 SO	S8+5	<a href="#">21-0041</a>	<a href="#">90-0096</a>