

MAX13050/MAX13052/ MAX13053/MAX13054

Industry-Standard High-Speed CAN Transceivers with $\pm 80\text{V}$ Fault Protection

General Description

The MAX13050/MAX13052/MAX13053/MAX13054 are pin-for-pin compatible, industry-standard, high-speed, control area network (CAN) transceivers with extended $\pm 80\text{V}$ fault protection. These products are ideal industrial network applications where overvoltage protection is required. These CAN transceivers provide a link between the CAN protocol controller and the physical wires of the bus lines in a CAN. These devices can be used for DeviceNet[®] applications, requiring data rates up to 1Mbps.

The CAN transceivers have an input common-mode range greater than $\pm 12\text{V}$, exceeding the ISO11898 specification of -2V to $+7\text{V}$, and feature $\pm 8\text{kV}$ ESD protection, making these devices ideal for harsh industrial environments.

The CAN transceivers provide a dominant timeout function that prevents erroneous CAN controllers from clamping the bus to a dominant level if the TXD input is held low for greater than 1ms. The MAX13050/MAX13052 provide a SPLIT pin used to stabilize the recessive common-mode voltage. The MAX13052 also has a slope-control mode that can be used to program the slew rate of the transmitter for data rates of up to 500kbps. The MAX13053 features a silent mode that disables the transmitter. The MAX13053 also has a reference output that can be used to bias the input of older CAN controllers that have a differential comparator. The MAX13054 has a separate dedicated logic input (V_{CC2}) allowing interfacing with a $+3.3\text{V}$ microcontroller.

The MAX13050/MAX13052/MAX13053/MAX13054 are available in an 8-pin SO package and are specified to operate in the -40°C to $+85^{\circ}\text{C}$ and the -40°C to $+125^{\circ}\text{C}$ temperature ranges.

Benefits and Features

- Fully Compatible with the ISO11898 Standard
- $\pm 8\text{kV}$ ESD IEC 61000-4-2 Contact Discharge per IBEE Test Facility
- $\pm 80\text{V}$ Fault Protection
- $+3.3\text{V}$ Logic Compatible (MAX13054)
- High-Speed Operation of Up to 1Mbps
- Slope-Control Mode (MAX13052)
- Greater than $\pm 12\text{V}$ Common-Mode Range
- Low-Current Standby Mode
- Silent Mode (MAX13053)
- Thermal Shutdown
- Short-Circuit Protection
- Transmit (TXD) Data Dominant Timeout
- Current Limiting
- SPLIT Pin (MAX13050/MAX13052)

Applications

- DeviceNet Nodes
- Medium- and Heavy-Duty Truck Systems
- Industrial

Functional Diagrams and Typical Operating Circuits appear at end of data sheet.

DeviceNet is a registered trademark of the Open DeviceNet Vendor Association.

MAX13050/MAX13052/
MAX13053/MAX13054

Industry-Standard High-Speed CAN
Transceivers with ±80V Fault Protection

Absolute Maximum Ratings

V _{CC} , V _{CC2}	-0.3V to +6V	Operating Temperature Range	-40°C to +125°C
RS	-0.3V to (V _{CC} + 0.3V)	Junction Temperature	+150°C
TXD, STBY, S, REF, RXD	-0.3V to +6V	Storage Temperature Range	-65°C to +150°C
CANH, CANL, SPLIT	± 80V	Lead Temperature (soldering, 10s)	+300°C
Continuous Power Dissipation (T _A = +70°C)		Soldering Temperature (reflow)	+260°C
8-Pin SO (derate 5.9mW/°C above +70°C)	470mW		

Stresses beyond those listed under "Absolute Maximum Ratings" may cause permanent damage to the device. These are stress ratings only, and functional operation of the device at these or any other conditions beyond those indicated in the operational sections of the specifications is not implied. Exposure to absolute maximum rating conditions for extended periods may affect device reliability.

DC Electrical Characteristics

(V_{CC} = +5V ±5%, V_{CC2} = +3V to +3.6V, T_A = T_{MIN} to T_{MAX}, unless otherwise noted. Typical values are at V_{CC} = +5V, V_{CC2} = +3.3V, R_L = 60Ω, and T_A = +25°C.) (Note 1)

PARAMETER	SYMBOL	CONDITIONS	MIN	TYP	MAX	UNITS
V _{CC} Supply Current	I _{CC}	Dominant, R _L = 60Ω			72	mA
		Recessive	MAX13050/MAX13052/ MAX13053		12.5	
			MAX13054		10	
V _{CC2} Supply Current	I _{CC2}	MAX13054, TXD = V _{CC2} or unconnected			15	μA
Standby Current	I _{STANDBY}	MAX13052			25	μA
		MAX13050/MAX13054			11	
Silent Mode	I _{SILENT}	MAX13053			12.5	mA
Thermal-Shutdown Threshold	T _{SH}			+165		°C
Thermal-Shutdown Hysteresis				13		°C
INPUT LEVELS (TXD, STBY, S)						
High-Level Input Voltage	V _{IH}		2			V
		TXD, STBY (MAX13054)	0.7 x V _{CC2}			
Low-Level Input Voltage	V _{IL}		0.8			V
		TXD, STBY (MAX13054)	0.3 x V _{CC2}			
High-Level Input Current	I _{IH}	V _{TXD} = V _{CC} , V _{TXD} = V _{CC2} (MAX13054)	-5		+5	μA
		V _{STBY} = V _{CC} , V _S = V _{CC} (MAX13053)	-5		+5	
Low-Level Input Current	I _{IL}	V _{TXD} = GND	-300		-100	μA
		V _{STBY} = GND, V _S = GND (MAX13053)	-10		-1	
Input Capacitance	C _{IN}			10		pF
CANH, CANL TRANSMITTER						
Recessive Bus Voltage	V _{CANH} , V _{CANL}	Normal mode, V _{TXD} = V _{CC} , no load	2		3	V
		Standby mode, no load	-100		+100	mV
Recessive Output Current	I _{CANH} , I _{CANL}	V _{CANH} , V _{CANL} = ±76V	±3			mA
		-32V ≤ V _{CANH} , V _{CANL} ≤ +32V	-2.5		+2.5	
CANH Output Voltage	V _{CANH}	V _{TXD} = 0, dominant	3.0		4.25	V
CANL Output Voltage	V _{CANL}	V _{TXD} = 0, dominant	0.50		1.75	V
Matching Between CANH and CANL Output Voltage	ΔDOM	V _{TXD} = 0, dominant, T _A = +25°C, (V _{CANH} + V _{CANL}) - V _{CC}	-100		+150	mV

DC Electrical Characteristics (continued)

($V_{CC} = +5V \pm 5\%$, $V_{CC2} = +3V$ to $+3.6V$, $T_A = T_{MIN}$ to T_{MAX} , unless otherwise noted. Typical values are at $V_{CC} = +5V$, $V_{CC2} = +3.3V$, $R_L = 60\Omega$, and $T_A = +25^\circ C$.) (Note 1)

PARAMETER	SYMBOL	CONDITIONS	MIN	TYP	MAX	UNITS
Differential Output ($V_{CANH} - V_{CANL}$)	V_{DIFF}	Dominant, $V_{TXD} = 0$, $45\Omega \leq R_L \leq 60\Omega$	1.5		3.0	V
		Recessive, $V_{TXD} = V_{CC}$, no load	-50		+50	mV
CANH Short-Circuit Current	I_{CANHSC}	$V_{CANH} = 0$, $V_{TXD} = 0$	-100	-70	-45	mA
CANL Short-Circuit Current	I_{CANLSC}	$V_{CANL} = 5V$, $V_{TXD} = 0$	40	60	90	mA
		$V_{CANL} = 40V$, $V_{TXD} = 0$ (Note 2)	40	60	90	
		$V_{CANL} = 76V$, $V_{TXD} = 0$		63		
RXD OUTPUT LEVELS						
RXD High-Output-Voltage Level	V_{OH}	$I = -100\mu A$	$0.8 \times V_{CC}$		V_{CC}	V
		$I = -100\mu A$ (MAX13054)	$0.8 \times V_{CC2}$		V_{CC2}	
RXD Low-Output-Voltage Level	V_{OL}	$I = 5mA$			0.4	V
COMMON-MODE STABILIZATION (SPLIT) and REF						
Output Voltage	V_{SPLIT}	Normal mode, $-500\mu A \leq I_{SPLIT} \leq 500\mu A$	$0.3 \times V_{CC}$		$0.7 \times V_{CC}$	V
Leakage Current	I_{LEAK}	Standby mode, $-40V \leq V_{SPLIT} \leq +40V$			20	μA
		Standby mode, $-76V \leq V_{SPLIT} \leq +76V$			50	
REF Output Voltage	V_{REF}	$-50\mu A \leq I_{REF} \leq +50\mu A$ (MAX13053)	$0.45 \times V_{CC}$		$0.55 \times V_{CC}$	V
DC BUS RECEIVER ($V_{TXD} = V_{CC}$, CANH and CANL externally driven)						
Differential Input Voltage	V_{DIFF}	$-12V \leq V_{CM} \leq +12V$	0.5	0.7	0.9	V
		MAX13050/MAX13052/MAX13054 $-12V \leq V_{CM} \leq +12V$ (standby mode)	0.50		1.15	
Differential Input Hysteresis	$V_{DIFF(HYST)}$	Normal mode, $-12V \leq V_{CM} \leq +12V$		70		mV
Common-Mode Input Resistance	R_{ICM}	Normal or standby mode, $V_{CANH} = V_{CANL} = \pm 12V$	15		35	k Ω
Matching Between CANH and CANL Common-Mode Input Resistance	R_{IC_MATCH}	$V_{CANH} = V_{CANL}$	-3		+3	%
Differential Input Resistance	R_{DIFF}	Normal or standby mode, $V_{CANH} - V_{CANL} = 1V$	25		75	k Ω
Common-Mode Input Capacitance	C_{IM}	$V_{TXD} = V_{CC}$		20		pF
Differential Input Capacitance		$V_{TXD} = V_{CC}$		10		pF
Input Leakage Current	I_{LI}	$V_{CC} = 0$, $V_{CANH} = V_{CANL} = 5V$	-5		+5	μA
SLOPE CONTROL RS (MAX13052)						
Input Voltage for High Speed	V_{IL_RS}				$0.3 \times V_{CC}$	V

DC Electrical Characteristics (continued)

($V_{CC} = +5V \pm 5\%$, $V_{CC2} = +3V$ to $+3.6V$, $T_A = T_{MIN}$ to T_{MAX} , unless otherwise noted. Typical values are at $V_{CC} = +5V$, $V_{CC2} = +3.3V$, $R_L = 60\Omega$, and $T_A = +25^\circ C$.) (Note 1)

PARAMETER	SYMBOL	CONDITIONS	MIN	TYP	MAX	UNITS
Input Voltage for Standby	V_{IH_RS}		$0.75 \times V_{CC}$			V
Slope-Control Mode Voltage	V_{SLOPE}	$-200\mu A < I_{RS} < 10\mu A$	$0.4 \times V_{CC}$		$0.6 \times V_{CC}$	V
High-Speed Mode Current	I_{L_RS}	$V_{RS} = 0$	-500			μA
ESD Protection		IEC 61000-4-2 Contact Discharge Method per IBEE test facility (Note 3)		± 8		kV

Timing Characteristics

($V_{CC} = +5V \pm 5\%$, $V_{CC2} = +3V$ to $+3.6V$, $R_L = 60\Omega$, $C_L = 100pF$, $T_A = T_{MIN}$ to T_{MAX} , unless otherwise noted. Typical values are at $V_{CC} = +5V$, $V_{CC2} = +3.3V$, and $T_A = +25^\circ C$.)

PARAMETER	SYMBOL	CONDITIONS		MIN	TYP	MAX	UNITS
Delay TXD to Bus Active	t_{ONTXD}	Figure 1 (Note 4)			66	110	ns
Delay TXD to Bus Inactive	t_{OFFTXD}	Figure 1 (Note 4)	MAX13050/MAX13052/ MAX13053		61	95	ns
			MAX13054		70	110	
Delay Bus to Receiver Active	t_{ONRXD}	Figure 1 (Note 4)			54	115	ns
Delay Bus to Receiver Inactive	t_{OFFRXD}	Figure 1 (Note 4)			46	160	ns
Delay TXD to RXD Active (Dominant Loop Delay)	t_{ONLOOP}	Figure 1 (Note 4)			121	255	ns
Delay TXD to RXD Inactive (Recessive Loop Delay)	$t_{OFFLOOP}$	Figure 4 (Note 4)			108	255	ns
Delay TXD to RXD Active (Dominant Loop Delay) Slew-Rate Controlled	$t_{ONLOOP-S}$	MAX13052	$R_{RS} = 24k\Omega$ (500kbps)		280	450	μs
			$R_{RS} = 100k\Omega$ (125kbps)		0.82	1.6	
			$R_{RS} = 180k\Omega$ (62.5kbps)		1.37	5	
Delay TXD to RXD Inactive (Loop Delay) Slew-Rate Controlled	$t_{OFFLOOP-S}$	MAX13052	$R_{RS} = 24k\Omega$ (500kbps)		386	600	μs
			$R_{RS} = 100k\Omega$ (125kbps)		0.74	1.6	
			$R_{RS} = 180k\Omega$ (62.5kbps)		0.97	5	
Differential Output Slew Rate	ISRI	MAX13052	$R_{RS} = 24k\Omega$ (500kbps)		10		V/ μs
			$R_{RS} = 100k\Omega$ (125kbps)		2.7		
			$R_{RS} = 180k\Omega$ (62.5kbps)		1.6		

Timing Characteristics (continued)

($V_{CC} = +5V \pm 5\%$, $V_{CC2} = +3V$ to $+3.6V$, $R_L = 60\Omega$, $C_L = 100pF$, $T_A = T_{MIN}$ to T_{MAX} , unless otherwise noted. Typical values are at $V_{CC} = +5V$, $V_{CC2} = +3.3V$, and $T_A = +25^\circ C$.)

PARAMETER	SYMBOL	CONDITIONS	MIN	TYP	MAX	UNITS
Dominant Time for Wake-Up with Bus	t_{WAKE}	Standby mode, $V_{DIFF} = +3V$, Figure 2	0.75	1.5	3.00	μs
Delay STBY to Normal Mode (DOMINANT)	$t_{STBY-NORM}$	$TXD = 0$ (MAX13050, MAX13054) FROM STBY falling to $CANH - CANL = 0.9V$	5		10	μs
TXD Dominant Timeout	t_{DOM}	$V_{TXD} = 0$	0.3	0.6	1.0	ms

Note 1: All currents into the device are positive, all currents out of the device are negative. All voltages are referenced to the device ground, unless otherwise noted.

Note 2: Guaranteed by design, not production tested.

Note 3: ESD tested by IBEE test facility. Please contact factory for report.

Note 4: For the MAX13052, $V_{RS} = 0$.

Timing Diagrams



Figure 1. Timing Diagram

Timing Diagrams (continued)



Figure 2. Timing Diagram for Standby and Wake-Up Signal

Typical Operating Characteristics

($V_{CC} = +5V$, $R_L = 60\Omega$, $C_L = 100pF$, $V_{CC2} = +3.3V$, and $T_A = +25^\circ C$, unless otherwise noted.)

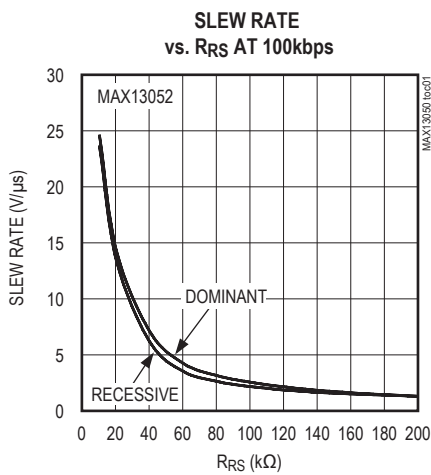

Typical Operating Characteristics (continued)

($V_{CC} = +5V$, $R_L = 60\Omega$, $C_L = 100pF$, $V_{CC2} = +3.3V$, and $T_A = +25^\circ C$, unless otherwise noted.)

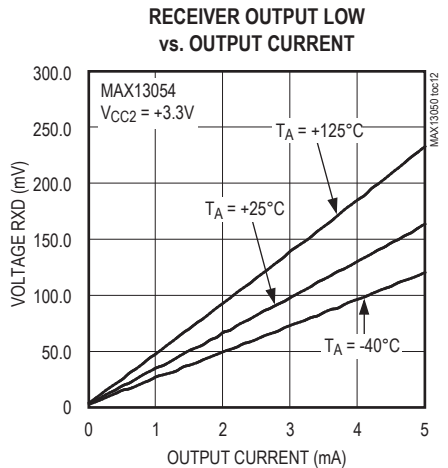
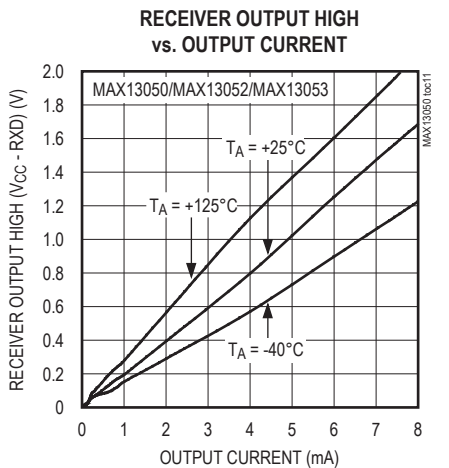
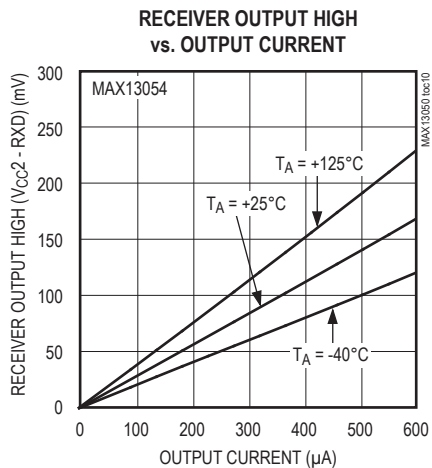
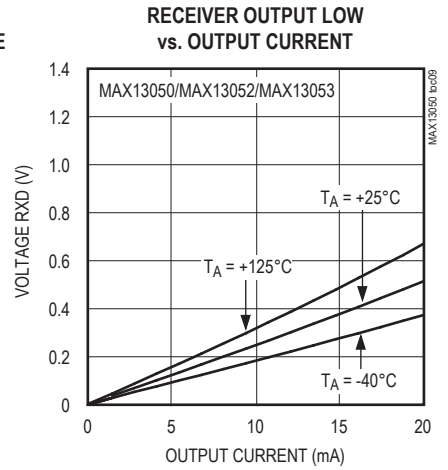
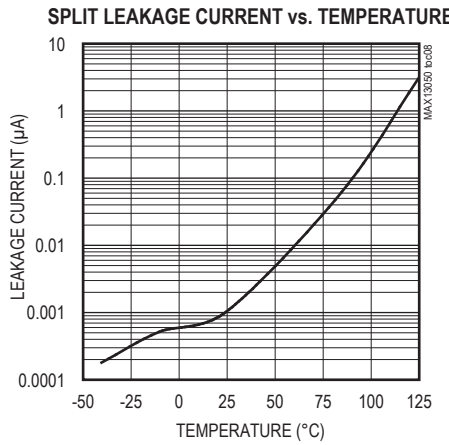
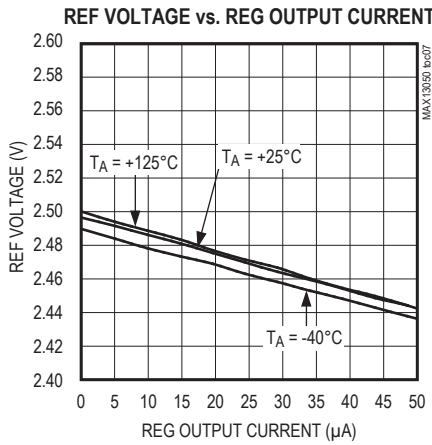
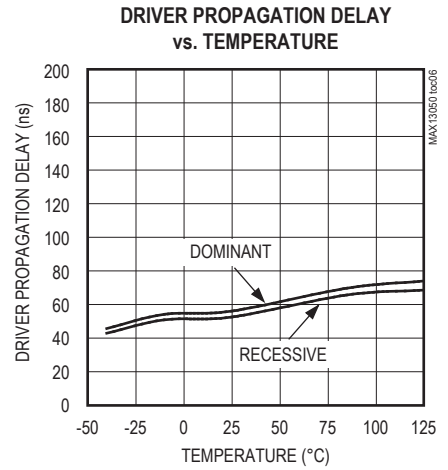
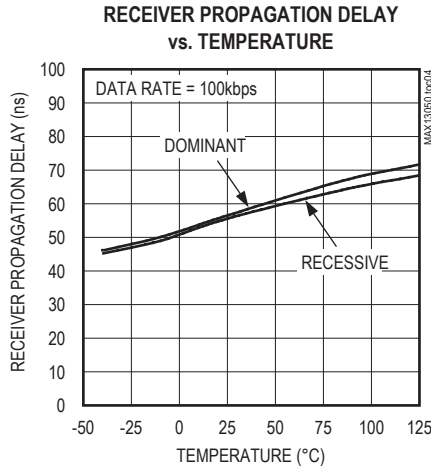
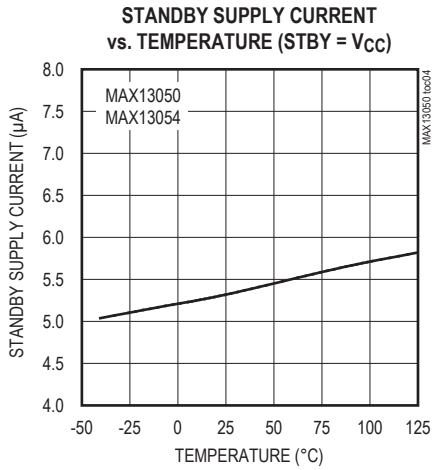

Typical Operating Characteristics (continued)

($V_{CC} = +5V$, $R_L = 60\Omega$, $C_L = 100pF$, $V_{CC2} = +3.3V$, and $T_A = +25^\circ C$, unless otherwise noted.)

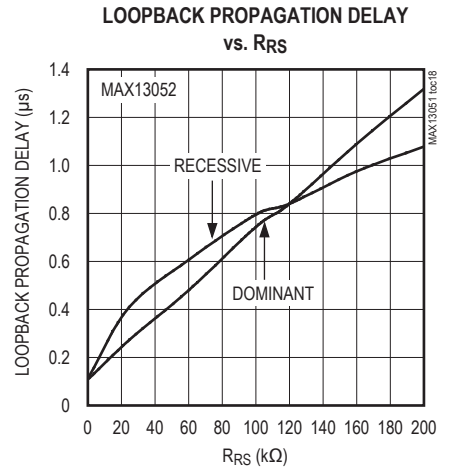
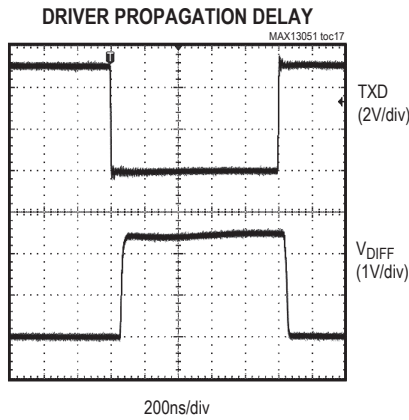
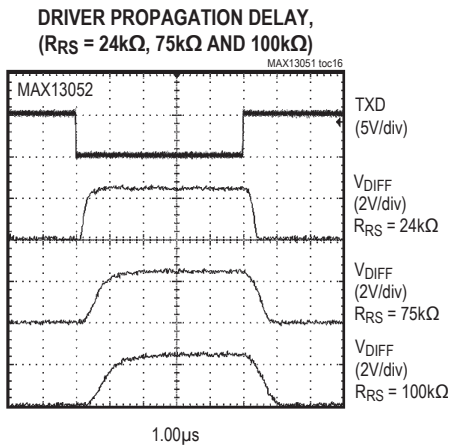
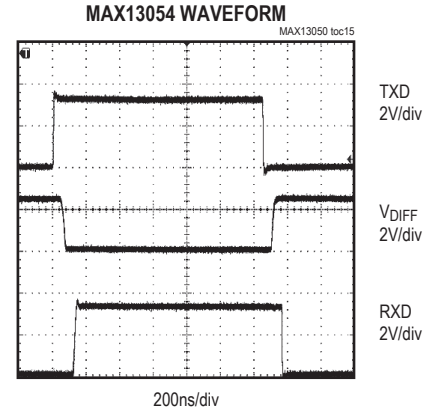
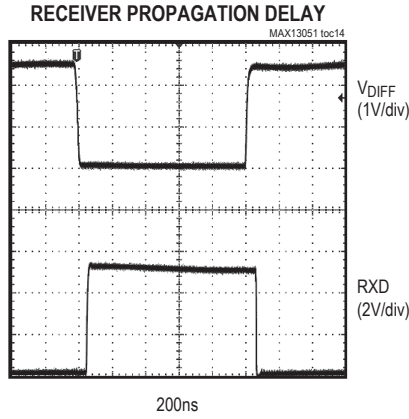
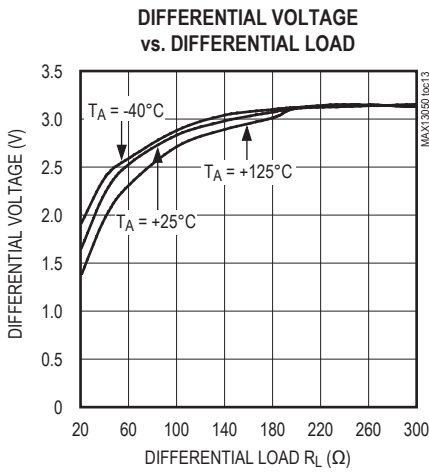

Pin Configurations

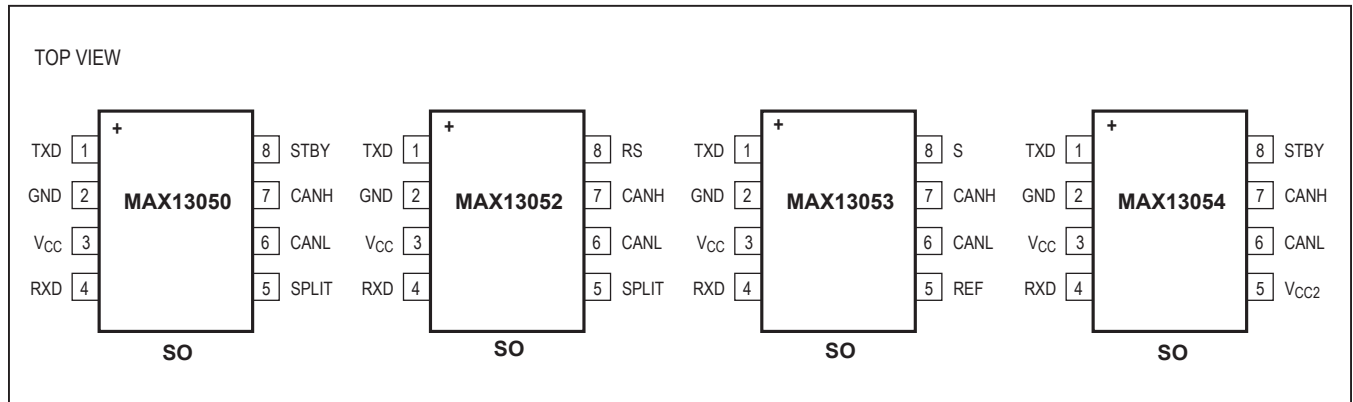

Pin Description

PIN				NAME	FUNCTION
MAX13050	MAX13052	MAX13053	MAX13054		
1	1	1	1	TXD	Transmit Data Input. TXD is a CMOS/TTL-compatible input from a CAN controller with a 25k Ω pullup to V _{CC} . For the MAX13054, TXD is pulled to V _{CC2} .
2	2	2	2	GND	Ground
3	3	3	3	V _{CC}	Supply Voltage. Bypass V _{CC} to GND with a 0.1 μ F capacitor.
4	4	4	4	RXD	Receive Data Output. RXD is a CMOS/TTL-compatible output from the physical bus lines CANH and CANL. For the MAX13054, RXD output voltage is referenced to the V _{CC2} supply voltage.
5	5	—	—	SPLIT	Common-Mode Stabilization Output. Output equaled to 0.5 x V _{CC} . SPLIT goes high impedance in standby mode .
6	6	6	6	CANL	CAN Bus-Line Low
7	7	7	7	CANH	CAN Bus-Line High
8	—	—	8	STBY	Standby Input. Drive STBY low for high-speed operation. Drive STBY high to place the device in low-current standby mode.
—	8	—	—	RS	Mode-Select Input. Drive RS low or connect to GND for high-speed operation. Connect a resistor between RS and GND to control output slope. Drive RS high to put into standby mode.
—	—	5	—	REF	Reference Output Voltage. Always on reference output voltage, set to 0.5 x V _{CC} .
—	—	8	—	S	Silent-Mode Input. Drive S low to enable TXD and to operate in high-speed mode. Drive S high to disable the transmitter.
—	—	—	5	V _{CC2}	Logic-Supply Input. V _{CC2} is the logic supply voltage for the input/output between the CAN transceiver and microprocessor. V _{CC2} allows fully compatible +3.3V logic on all digital lines. Bypass to GND with a 0.1 μ F capacitor. Connect V _{CC2} to V _{CC} for 5V logic compatibility.

MAX13050/MAX13052/ MAX13053/MAX13054

Detailed Description

The MAX13050/MAX13052/MAX13053/MAX13054 $\pm 80V$ fault-protected CAN transceivers are ideal for industrial network applications where overvoltage protection is required. These devices provide a link between the CAN protocol controller and the physical wires of the bus lines in a control area network (CAN). These devices can be used for DeviceNet applications, requiring data rates up to 1Mbps.

The devices' dominant timeout prevents the bus from being blocked by a hungup microcontroller. If the TXD input is held low for greater than 1ms, the transmitter becomes disabled, driving the bus line to a recessive state. The MAX13054 +3.3V logic input allows the device to communicate with +3.3V logic, while operating from a +5V supply. The MAX13050 and MAX13052 provide a split DC-stabilized voltage. The MAX13053 has a reference output that can be used to bias the input of a CAN controller's differential comparator.

All devices can operate up to 1Mbps (high-speed mode). The MAX13052 slope-control feature allows the user to program the slew rate of the transmitter for data rates of up to 500kbps. This reduces the effects of EMI, thus allowing the use of unshielded-twisted or parallel cable. The MAX13050/MAX13052 and MAX13054 standby mode shuts off the transmitter and switches the receiver to a low-current/low-speed state.

The device input common-mode range is greater than $\pm 12V$, exceeding the ISO11898 specification of $-2V$ to $+7V$, and feature $\pm 8kV$ Contact Discharge protection, making these devices ideal for harsh industrial environments.

$\pm 80V$ Fault Protected

The devices feature $\pm 80V$ fault protection. This extended voltage range of CANH, CANL, and SPLIT allows use in high-voltage systems and communication with high-voltage buses.

Operating Modes

High-Speed Mode

The devices can achieve transmission rates of up to 1Mbps when operating in high-speed mode. Drive STBY low to operate the MAX13050 and MAX13054 in high-speed operation. Connect RS to ground to operate the MAX13052 in high-speed mode.

Slope-Control Mode (MAX13052)

Connect a resistor from RS to ground to select slope-control mode (Table 1). In slope-control mode, CANH and CANL slew rates are controlled by the resistor ($16k\Omega \leq R_{RS} \leq 200k\Omega$) connected between RS and GND. Controlling the rise and fall slopes reduces high-frequency

Industry-Standard High-Speed CAN Transceivers with $\pm 80V$ Fault Protection

Table 1. Mode Selection Truth Table
MAX13052

CONDITION FORCED AT RS	MODE	RESULTING CURRENT AT RS
$V_{RS} \text{ or } \leq 0.3 \times V_{CC}$	High-Speed	$ I_{RS} \leq 500\mu A$
$0.4 \times V_{CC} \leq V_{RS} \leq 0.6 \times V_{CC}$	Slope Control	$10\mu A \leq I_{RS} \leq 200\mu A$
$V_{RS} \geq 0.75 \times V_{CC}$	Standby	$ I_{RS} \leq 10\mu A$

EMI and allows the use of an unshielded-twisted pair or a parallel pair of wires as bus lines. The slew rate can be approximated using the formula below:

$$SR(V/\mu s) = \frac{250}{R_{RS}}$$

where, SR is the desired slew rate and R_{RS} is in $k\Omega$.

Standby Mode (MAX13050/MAX13052/MAX13054)

In standby mode (RS or STBY = high), the transmitter is switched off and the receiver is switched to a low-current/low-speed state. The supply current is reduced during standby mode. The bus line is monitored by a low-differential comparator to detect and recognize a wake-up event on the bus line. Once the comparator detects a dominant bus level greater than t_{WAKE} , RXD pulls low.

Drive STBY high for standby mode operation for the MAX13050 and MAX13054. Apply a logic-high to RS to enter a low-current standby mode for the MAX13052.

Silent Mode S (MAX13053)

Drive S high to place the MAX13053 in silent mode. When operating in silent mode, the transmitter is disabled regardless of the voltage level at TXD. RXD however, still monitors activity on the bus line.

Common-Mode Stabilization (SPLIT)

SPLIT provides a DC common-mode stabilization voltage of $0.5 \times V_{CC}$ when operating in normal mode. SPLIT stabilizes the recessive voltage to $0.5 \times V_{CC}$ for conditions when the recessive bus voltage is lowered, caused by an unpowered transceiver in the network with a significant leakage current from the bus lines to ground. Use SPLIT to stabilize the recessive common-mode voltage by connecting SPLIT to the center tap of the split termination, see the [Typical Operating Circuits](#). In standby mode or when $V_{CC} = 0$, SPLIT becomes high impedance.

Table 2. Transmitter and Receiver Truth Table (MAX13052)

TXD	RS	CANH	CANL	BUS STATE	RXD
Low	$V_{RS} \leq 0.75 \times V_{CC}$	High	Low	Dominant	Low
High or Open	$V_{RS} \leq 0.75 \times V_{CC}$	$V_{CC} / 2$	$V_{CC} / 2$	Recessive	High
X	$V_{RS} \geq 0.75 \times V_{CC}$	R_{ICM} to GND	R_{ICM} to GND	Recessive	High

Table 3. Transmitter and Receiver Truth Table (MAX13053)

TXD	RS	CANH	CANL	BUS STATE	RXD
Low	$V_S < 0.8V$	High	Low	Dominant	Low
High or Open	$V_S < 0.8V$	$V_{CC} / 2$	$V_{CC} / 2$	Recessive	High
X	$V_S > 2V$	$V_{CC} / 2$	$V_{CC} / 2$	Recessive	High

(MAX13050/MAX13054)

TXD	RS	CANH	CANL	BUS STATE	RXD
Low	$V_{STBY} \leq 0.8V$ $*V_{STBY} \leq 0.3 \times V_{CC2}$	High	Low	Dominant	Low
High or Open	$V_{STBY} \leq 0.8V$ $*V_{STBY} \leq 0.3 \times V_{CC2}$	$V_{CC} / 2$	$V_{CC} / 2$	Recessive	High
X	$V_{STBY} \geq 2V$ $*V_{STBY} \geq 0.7 \times V_{CC2}$	R_{ICM} to GND	R_{ICM} to GND	Recessive	High

*For the MAX13054



Figure 3. Transmitter Dominant Timeout Timing Diagram

Reference Output (MAX13053)

MAX13053 has a reference voltage output (REF) set to $0.5 \times V_{CC}$. REF can be utilized to bias the input of a CAN controller's differential comparator, and to provide power to external circuitry.

Transmitter

The transmitter converts a single-ended input (TXD) from the CAN controller to differential outputs for the bus lines (CANH, CANL). The truth table for the transmitter and receiver is given in [Table 2](#).

TXD Dominant Timeout

The CAN transceivers provide a transmitter dominant timeout function that prevents erroneous CAN controllers from clamping the bus to a dominant level by a continuous low TXD signal. When the TXD remains low for the 1ms maximum timeout period, the transmitter becomes disabled, thus driving the bus line to a recessive state ([Figure 3](#)). The transmitter becomes enabled upon detecting a rising edge at TXD.

Receiver

The receiver reads differential inputs from the bus lines (CANH, CANL) and transfers this data as a single-ended output (RXD) to the CAN controller. It consists of a comparator that senses the difference $V_{DIFF} = (CANH - CANL)$ with respect to an internal threshold of 0.7V. If this difference is positive (i.e., $V_{DIFF} > 0.7$), a logic-low is present at RXD. If negative (i.e., $V_{DIFF} < 0.7V$), a logic-high is present.

The CANH and CANL common-mode range is greater than $\pm 12V$. RXD is logic-high when CANH and CANL are shorted or terminated and undriven.

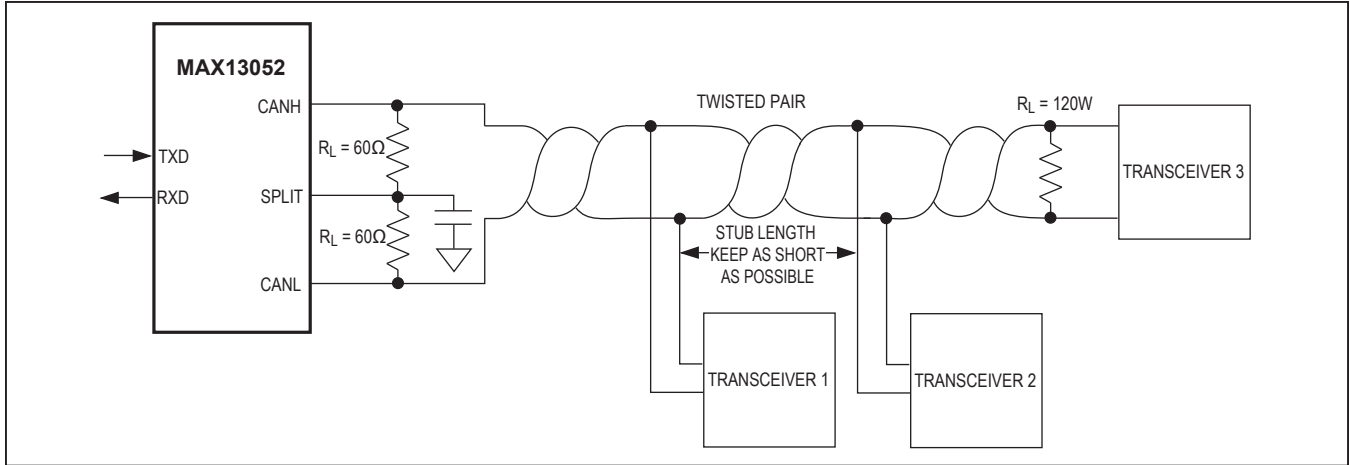

Figure 4. Multiple Receivers Connected to CAN Bus

+3.3V Logic Compatibility (MAX13054)

A separate input, V_{CC2} , allows the MAX13054 to communicate with +3.3V logic systems while operating from a +5V supply. This provides a reduced input voltage threshold to the TXD and STBY inputs, and provides a logic-high output at RXD compatible with the microcontroller's system voltage. The logic compatibility eliminates longer propagation delay due to level shifting. Connect V_{CC2} to V_{CC} to operate the MAX13054 with +5V logic systems.

Driver Output Protection

The current-limiting feature protects the transmitter output stage against a short circuit to a positive and negative battery voltage. Although the power dissipation increases during this fault condition, current-limit protection prevents destruction of the transmitter output stage. Upon removal of a short, the CAN transceiver resumes normal operation.

Thermal Shutdown

If the junction temperature exceeds $+165^{\circ}C$, the driver is switched off. The hysteresis is approximately $13^{\circ}C$, disabling thermal shutdown once the temperature drops below $+152^{\circ}C$. In thermal shutdown, CANH and CANL go recessive. After a thermal-shutdown event, the IC resumes normal operation when the junction temperature drops below the thermal-shutdown hysteresis, and upon the CAN transceiver detecting a rising edge at TXD.

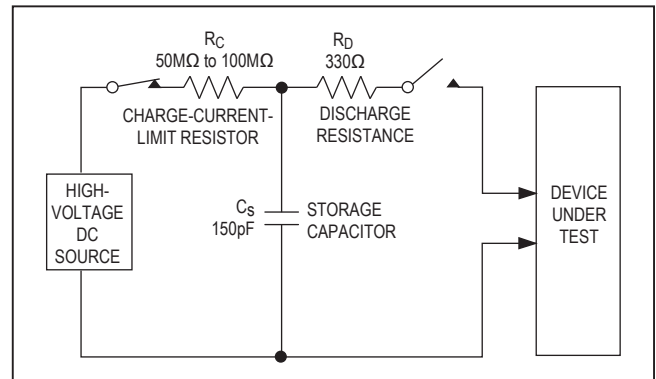

Figure 5. IEC 61000-4-2 Contact Discharge ESD Test Model

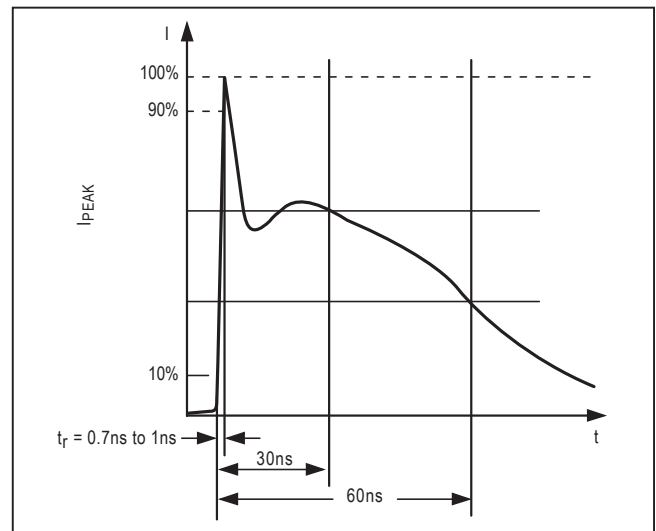

Figure 6. IEC 61000-4-2 ESD Test Model Current Waveform

Applications Information

Reduced EMI and Reflections

In slope-control mode, the MAX13052's CANH and CANL outputs are slew-rate limited, minimizing EMI and reducing reflections caused by improperly terminated cables.

In multidrop CAN applications, it is important to maintain a direct point-to-point wiring scheme. A single pair of wires should connect each element of the CAN bus, and the two ends of the bus should be terminated with 120Ω resistors, see [Figure 4](#). A star configuration should never be used.

Any deviation from the point-to-point wiring scheme creates a stub. The high-speed edge of the CAN data on a stub can create reflections back down the bus. These reflections can cause data errors by eroding the noise margin of the system.

Although stubs are unavoidable in a multidrop system, care should be taken to keep these stubs as small as possible, especially in high-speed mode. In slope-control mode, the requirements are not as rigorous, but stub length should still be minimized.

Layout Consideration

CANH and CANL are differential signals and steps should be taken to insure equivalent parasitic capacitance. Place the resistor at RS as close as possible to the MAX13052 to minimize any possible noise coupling at the input.

Power Supply and Bypassing

These devices require no special layout considerations beyond common practices. Bypass V_{CC} and V_{CC2} to GND with a $0.1\mu\text{F}$ ceramic capacitor mounted close to the IC with short lead lengths and wide trace widths.

ESD Protection

ESD-protection structures are incorporated on CANH and CANL to protect against ESD encountered during handling and assembly. CANH and CANL inputs have extra protection to protect against static electricity found in normal operation. Maxim's engineers have developed state-of-the-art structures to protect these pins against $\pm 8\text{kV}$ ESD Contact Discharge without damage. After an ESD event, the MAX13050/MAX13052/MAX13053/MAX13054 continue working without latchup. ESD protection can be tested in several ways. The CANH and CANL inputs are characterized for protection to $\pm 8\text{kV}$ using the IEC 61000-4-2 Contact Discharge Method per IBEE Test facility.

ESD Test Conditions

ESD performance depends on a number of conditions. Contact Maxim for a reliability report that documents test setup, methodology, and results.

Human Body Model

[Figure 5](#) shows the IEC 61000-4-2 Contact Discharge Model, and [Figure 6](#) shows the current waveform it generates when discharged into a low impedance. This model consists of a 100pF capacitor charged to the ESD voltage of interest, which is then discharged into the device through a $1.5\text{k}\Omega$ resistor.

Functional Diagrams



Functional Diagrams (continued)



Functional Diagrams (continued)

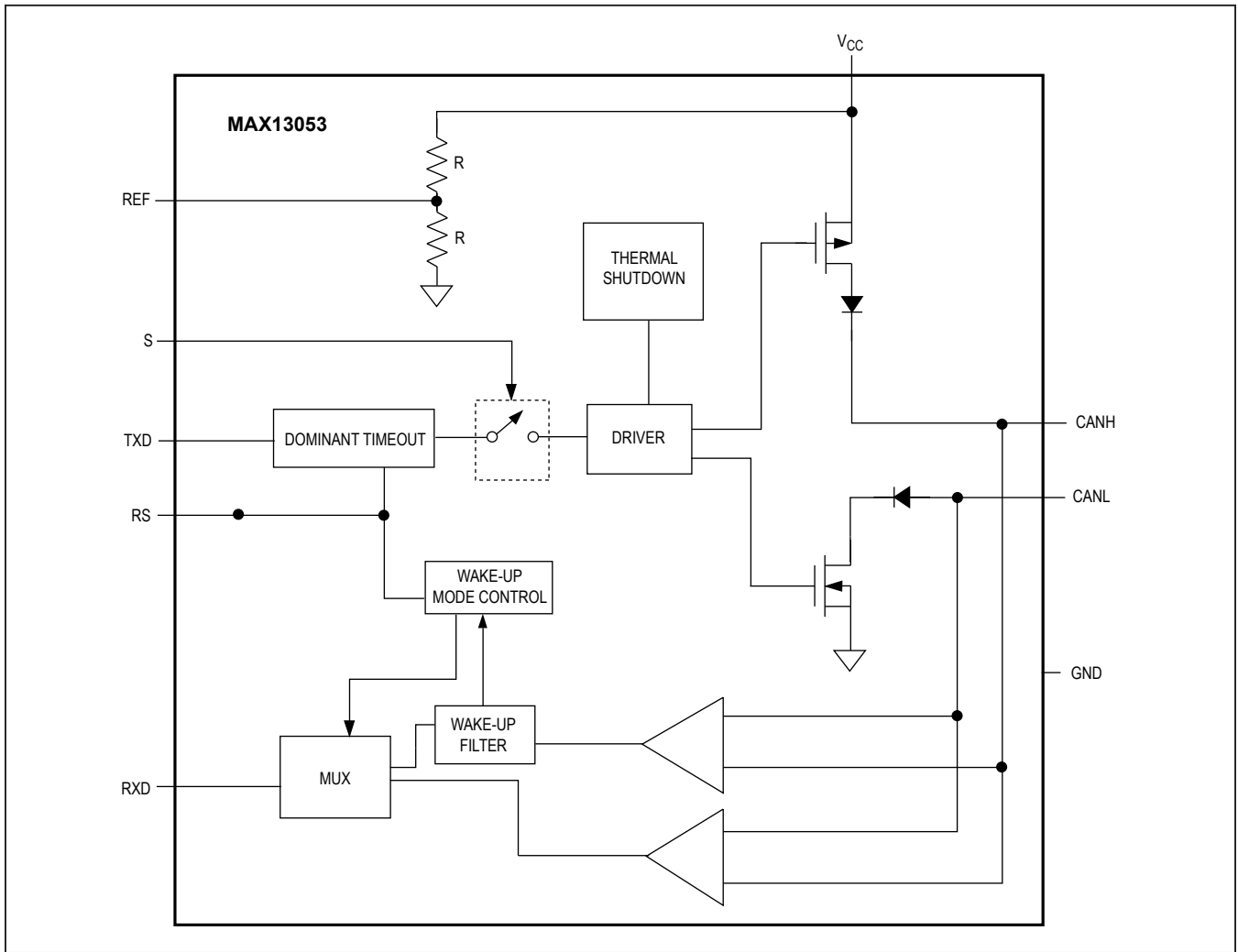

Functional Diagrams (continued)

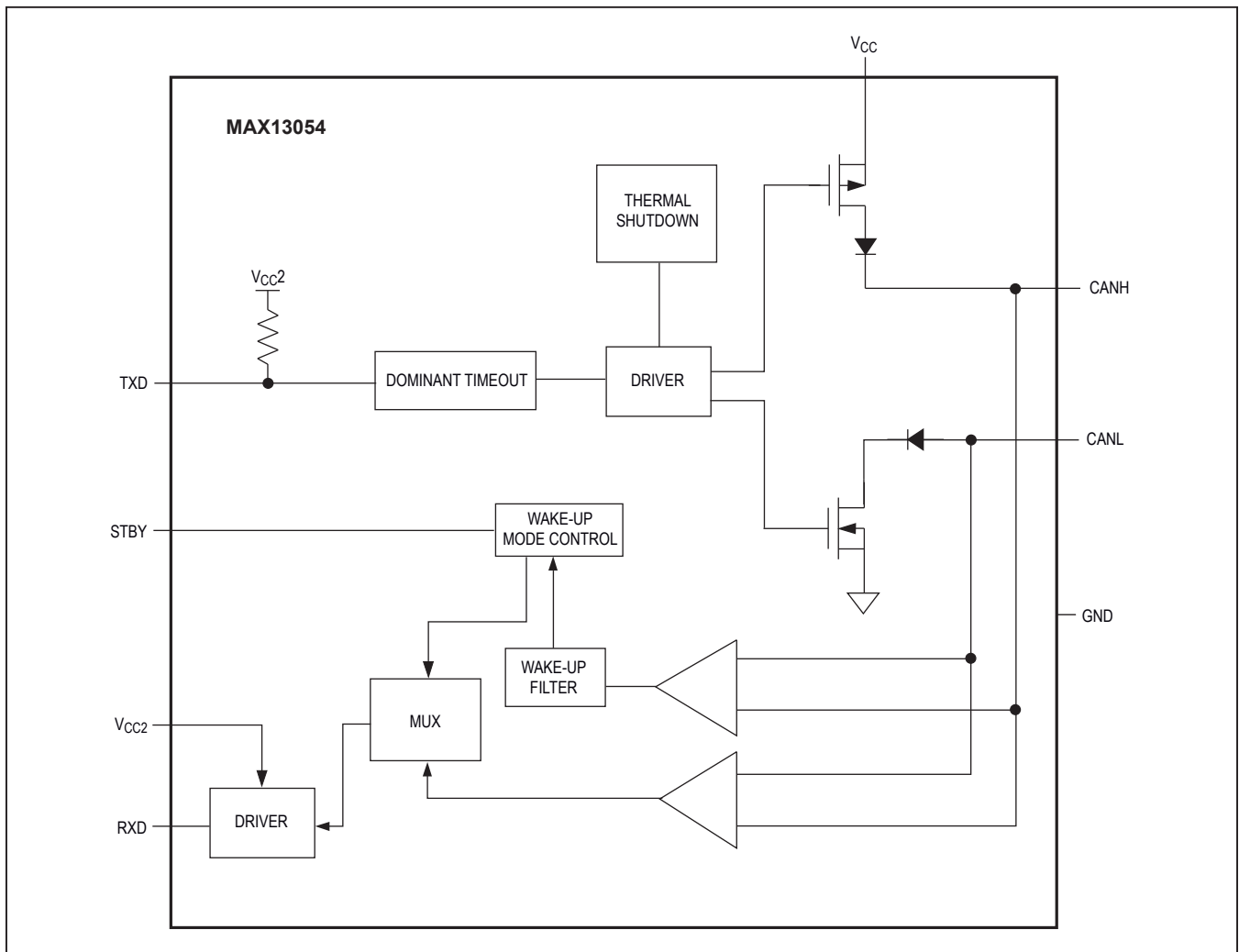

Typical Operating Circuits



Selector Guide

PART	SPLIT	SLOPE CONTROL	STANDBY MODE	SILENT MODE	3.3V SUPPLY	REF	PIN-FOR-PIN REPLACEMENT
MAX13050	Yes	—	Yes	—	—	—	TJA1040
MAX13052	Yes	Yes	Yes	—	—	—	PCA82C250/51
MAX13053	—	—	—	Yes	—	Yes	TJA1050, AMIS-30660
MAX13054	—	—	Yes	—	Yes	—	TLE6250v33, CF163

MAX13050/MAX13052/
MAX13053/MAX13054

Industry-Standard High-Speed CAN
Transceivers with $\pm 80V$ Fault Protection

Ordering Information

PART	TEMP RANGE	PIN-PACKAGE
MAX13050 ESA+	-40°C to +85°C	8 SO
MAX13050ASA+	-40°C to +125°C	8 SO
MAX13052 ESA+	-40°C to +85°C	8 SO
MAX13052ASA+	-40°C to +125°C	8 SO
MAX13053 ESA+	-40°C to +85°C	8 SO
MAX13053ASA+	-40°C to +125°C	8 SO
MAX13054 ESA+	-40°C to +85°C	8 SO
MAX13054ASA+	-40°C to +125°C	8 SO

+Denotes a lead(Pb)-free/RoHS-compliant package.

Chip Information

PROCESS: BICMOS

Package Information

For the latest package outline information and land patterns (footprints), go to www.maximintegrated.com/packages. Note that a "+", "#", or "-" in the package code indicates RoHS status only. Package drawings may show a different suffix character, but the drawing pertains to the package regardless of RoHS status.

PACKAGE TYPE	PACKAGE CODE	OUTLINE NO.	LAND PATTERN NO.
8 SO	S8M+5	21-0041	90-0096