

# MAX14630/MAX14632

## USB Charger Adapter Emulators

### General Description

The MAX14630/MAX14632 are USB adapter emulators with automatic host charger identification circuitry for USB dedicated chargers.

The devices allow USB wall adapters, travel chargers, and other dedicated chargers to identify themselves as a USB dedicated charger to USB devices, an Apple charger to Apple products, and a Samsung Galaxy dedicated charger port to legacy D+/D- short detection devices that use the D+ pullup of the USB transceiver.

The devices feature a control input that allows for charger mode selection. The MAX14630 supports both Apple 2A and USB Battery Charger (BC) revision 1.2 specification compliant devices in Autodetection 2A mode and Samsung Galaxy Tablet 2A devices in SS 2A mode. The MAX14632 supports Autodetection 2A mode as well as Autodetection 1A mode for compatibility with most Apple and USB BC compliant devices.

The devices are available in a 5-pin (2.9mm x 1.6mm) TSOT package and are specified over the -40°C to +85°C extended temperature range.

### Applications

USB Wall Charger and Travel Adapter  
 USB Car Charger and Cigarette Lighter Adapter  
 Universal Charger including iPod®/iPad®/iPhone®

### Benefits and Features

- ◆ **Optimized for Charging Adapters**
  - ◇ Flexible Device and Adapter Connection Order
  - ◇ Convenient CB Pin Controls the Charging Mode
- ◆ **Faster Charging**
  - ◇ Apple 2A Charging Capability in Autodetection Mode
  - ◇ Samsung Galaxy Tablet 2A Charging Capability (MAX14630)
- ◆ **Improved Charger Interoperability**
  - ◇ Meets New USB BC Revision 1.2 Specification
  - ◇ Backward Compatible with Previous USB BC Revisions
  - ◇ Meets China YD/T1591-2009 Charging Specification
- ◆ **Greater User Flexibility**
  - ◇ CB Pin Controls Charger Mode
- ◆ **Save Board Space**
  - ◇ 2.9mm x 1.6mm, 5-Pin TSOT Package

[Ordering Information](#) appears at end of data sheet.

### Typical Operating Circuit

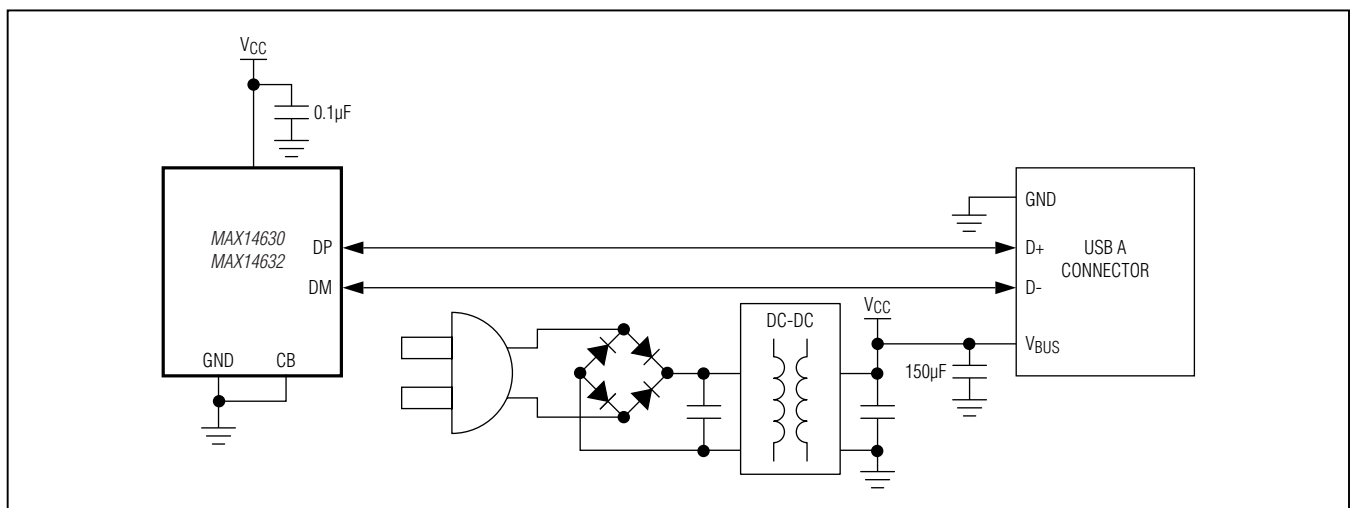

iPod, iPad, and iPhone are registered trademarks of Apple, Inc.

# MAX14630/MAX14632

## USB Charger Adapter Emulators

### ABSOLUTE MAXIMUM RATINGS

(All voltages referenced to GND.)

$V_{CC}$ , CB, DP, DM	-0.3V to +6V
Continuous Current into Any Terminal	$\pm 50\text{mA}$
Continuous Power Dissipation ( $T_A = +70^\circ\text{C}$ )	
TSOT (derate 4.8mW/ $^\circ\text{C}$ above $+70^\circ\text{C}$ )	386.5mW

Operating Temperature Range	$-40^\circ\text{C}$ to $+85^\circ\text{C}$
Maximum Junction Temperature	$+150^\circ\text{C}$
Storage Temperature Range	$-65^\circ\text{C}$ to $+150^\circ\text{C}$
Lead Temperature (soldering, 10s)	$+300^\circ\text{C}$
Soldering Temperature (reflow)	$+260^\circ\text{C}$

Stresses beyond those listed under "Absolute Maximum Ratings" may cause permanent damage to the device. These are stress ratings only, and functional operation of the device at these or any other conditions beyond those indicated in the operational sections of the specifications is not implied. Exposure to absolute maximum rating conditions for extended periods may affect device reliability.

### PACKAGE THERMAL CHARACTERISTICS (Note 1)

TSOT

Junction-to-Ambient Thermal Resistance ( $\theta_{JA}$ )	$207^\circ\text{C/W}$
Junction-to-Case Thermal Resistance ( $\theta_{JC}$ )	$50^\circ\text{C/W}$

**Note 1:** Package thermal resistances were obtained using the method described in JEDEC specification JESD51-7, using a four-layer board. For detailed information on package thermal considerations, refer to [www.maximintegrated.com/thermal-tutorial](http://www.maximintegrated.com/thermal-tutorial).

### ELECTRICAL CHARACTERISTICS

( $V_{CC} = 3.0\text{V}$  to  $5.5\text{V}$ ,  $T_A = -40^\circ\text{C}$  to  $+85^\circ\text{C}$ , unless otherwise noted. Typical values are at  $V_{CC} = +5.0\text{V}$ ,  $T_A = +25^\circ\text{C}$ , unless otherwise noted.) (Note 2)

PARAMETER	SYMBOL	CONDITIONS	MIN	TYP	MAX	UNITS
<b>POWER SUPPLY</b>						
Operating Power-Supply Range	$V_{CC}$		3		5.5	V
		Apple divider valid range	4.75		5.5	V
$V_{CC}$ Supply Current	$I_{CC}$	$V_{CC} = 5.0\text{V}$		25	42	$\mu\text{A}$
POR				1.5		V
POR Delay	$t_{POR}$			100		ms
<b>ANALOG SWITCH</b>						
Analog Signal Range	$V_{DP}$ , $V_{DM}$		0		$V_{CC}$	V
On-Resistance of DP/DM Short	$R_{SHORT}$	$V_{CB} = 0\text{V}$ , $V_{DP} = 0.7\text{V}$ , $I_{DM\_SINK} = 100\mu\text{A}$ to GND		4.5	11	$\Omega$
<b>DYNAMIC</b>						
CB Switching Time	$t_{ON}$	CB = $V_{CC}$ to 0, 0 to $V_{CC}$		4		$\mu\text{s}$
<b>INTERNAL RESISTORS</b>						
DP/DM Short Pulldown	$R_{PD}$		350	500	700	$\text{k}\Omega$
$40V_{CC}$ Bias			39	40	41	$\%V_{CC}$
$54V_{CC}$ Bias			52.6	53.6	54.6	$\%V_{CC}$
$25V_{CC}$ Bias			24	25	26	$\%V_{CC}$

# MAX14630/MAX14632

## USB Charger Adapter Emulators

### ELECTRICAL CHARACTERISTICS (continued)

( $V_{CC} = 3.0V$  to  $5.5V$ ,  $T_A = -40^{\circ}C$  to  $+85^{\circ}C$ , unless otherwise noted. Typical values are at  $V_{CC} = +5.0V$ ,  $T_A = +25^{\circ}C$  unless otherwise noted.) (Note 2)

PARAMETER	SYMBOL	CONDITIONS	MIN	TYP	MAX	UNITS
<b>LOGIC INPUT (CB)</b>						
CB Input Logic-High	$V_{IH}$		1.4			V
CB Input Logic-Low	$V_{IL}$				0.4	V
CB Input Leakage Current	$I_{CB}$	$0 \leq V_{IN} \leq V_{IL}$ and $V_{IH} \leq V_{IN} \leq V_{CC}$ , $V_{CC} = 5.5V$	-1		1	$\mu A$

### COMPARATOR CHARACTERISTICS

( $V_{CC} = 4.75V$  to  $5.5V$ ,  $T_A = -40^{\circ}C$  to  $+85^{\circ}C$ , unless otherwise noted. Typical values are at  $V_{CC} = +5.0V$ ,  $T_A = +25^{\circ}C$ , unless otherwise noted.) (Notes 2, 3)

PARAMETER	SYMBOL	CONDITIONS	MIN	TYP	MAX	UNITS	
DM1 Comparator Threshold	$V_{DM1F}$	DM falling	MAX14632: CB = 0	40	41	42	% $V_{CC}$
			MAX14630: CB = 0	31	32	33	
			MAX14632: CB = 1				
DM2 Comparator Threshold	$V_{DM2F}$	DM falling	6.31	7	7.62	% $V_{CC}$	
DM2 Comparator Hysteresis				1		%	
DP Comparator Threshold	$V_{DPR}$	DP rising	MAX14632: CB = 0	45	46	47	% $V_{CC}$
			MAX14630: CB = 0	57	58	59	
			MAX14632: CB = 1				
DP Comparator Hysteresis				1		%	

**Note 2:** All units are 100% production tested at  $T_A = +25^{\circ}C$ . Specifications over operating temperature range are guaranteed by design.

**Note 3:** The comparators are disabled during the POR delay.

# MAX14630/MAX14632

## USB Charger Adapter Emulators

### Typical Operating Characteristics

( $V_{CC} = 5.0V$ ,  $T_A = +25^\circ C$ , unless otherwise noted.)

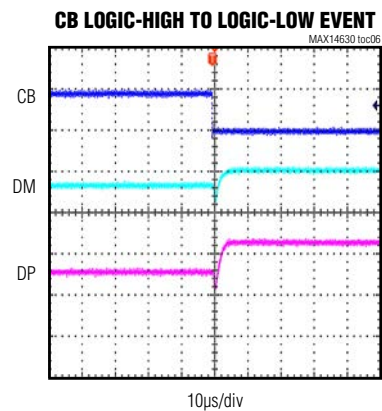
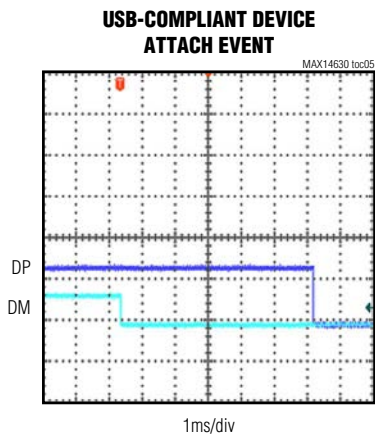
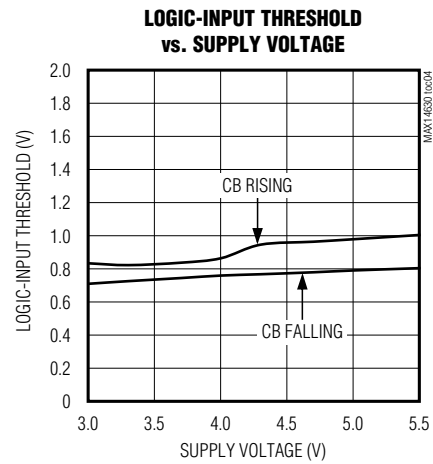
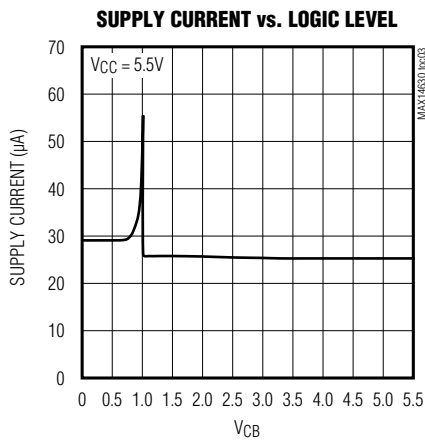
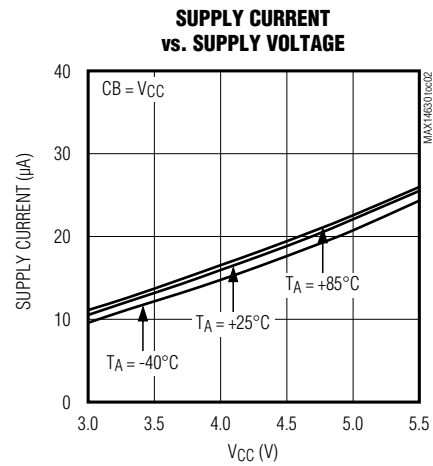
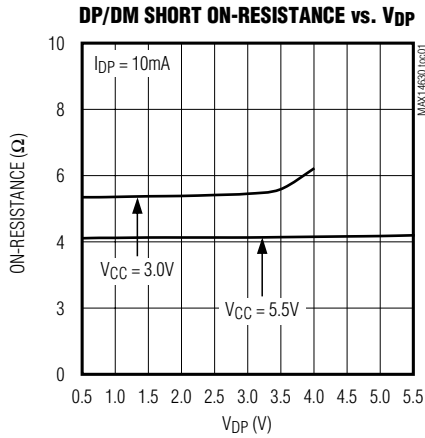

# MAX14630/MAX14632

## USB Charger Adapter Emulators

### Pin Configuration

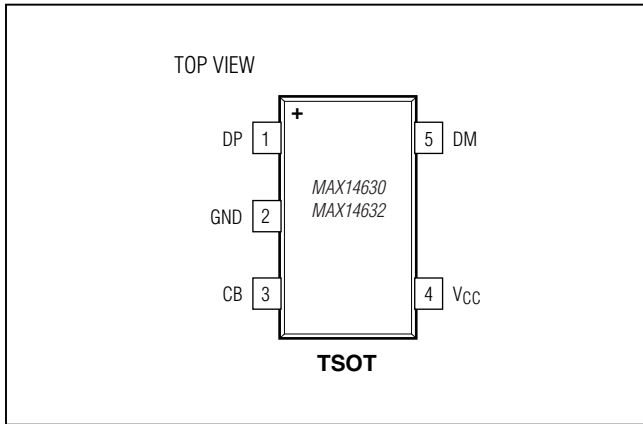

### Pin Description

PIN	NAME	FUNCTION
1	DP	USB Connector D+ Connection
2	GND	IC Ground. Return to the transformer output.
3	CB	Control Bit
4	VCC	Power Supply. Bypass V <sub>CC</sub> with a 0.1μF ceramic capacitor as close as possible to the pin.
5	DM	USB Connector D- Connection

### Functional Diagram

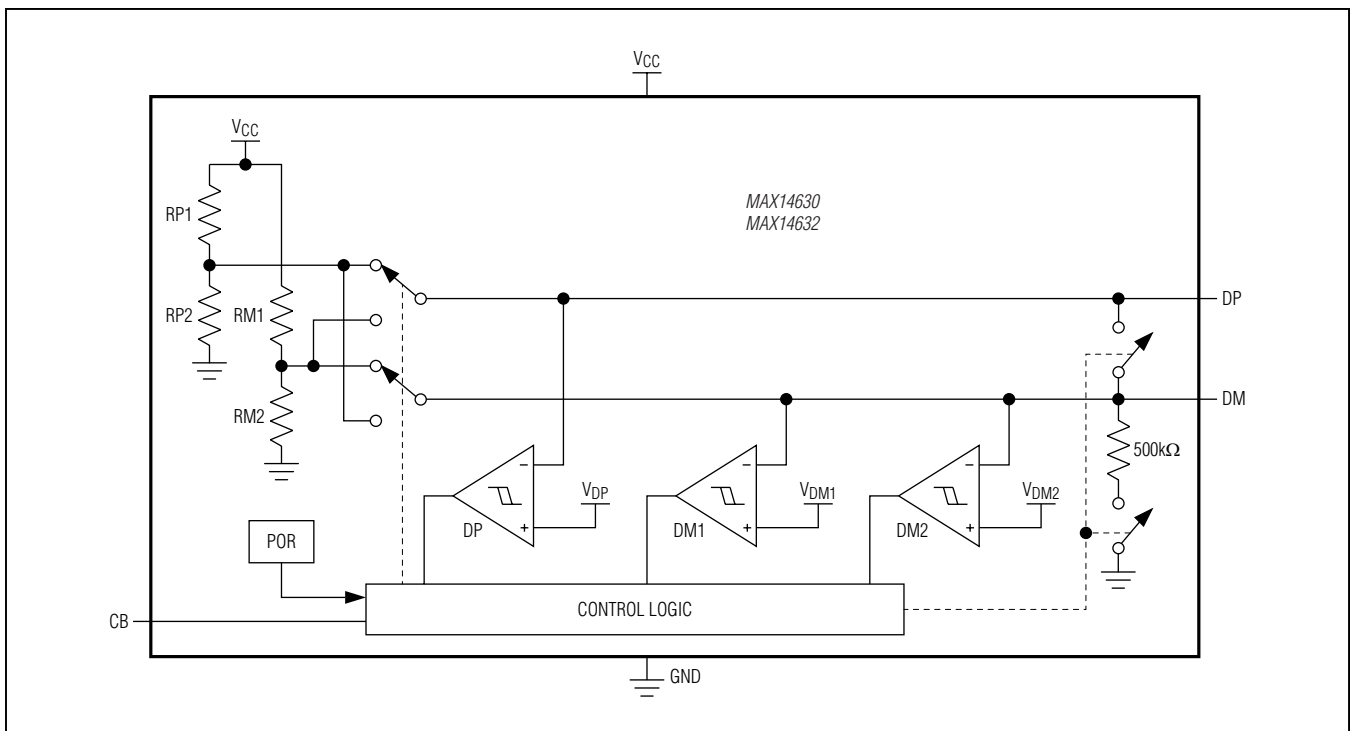

# MAX14630/MAX14632

## USB Charger Adapter Emulators

### **Detailed Description**

The MAX14630/MAX14632 are USB adapter emulators with automatic charger identification circuitry for USB dedicated chargers.

The devices allow USB wall adapters, travel chargers, and other dedicated chargers to identify themselves as a USB dedicated charger to USB devices, an Apple charger to Apple products, and a Samsung Galaxy dedicated charger port to legacy D+/D- short detection devices that use the D+ pullup of the USB transceiver.

### **Resistor-Dividers**

The devices feature internal resistor-dividers for biasing data lines to provide support for Apple-compliant devices.

### **Mode Control**

The devices feature a digital input, CB, for mode selection. For MAX14630, connect CB to a logic-level low voltage for Autodetection 2A charger mode or to a logic-level high voltage for Samsung 2A charger mode. See [Table 1](#). For the MAX14632, connect CB to a logic-level high voltage for Autodetection 2A charger

mode. Connect CB to a logic-level low voltage to place the MAX14632 in Autodetection 1A charger mode. See [Table 2](#).

### **Autodetection**

The MAX14630/MAX14632 feature Autodetection mode for dedicated chargers. In Autodetection charger mode, the device monitors the voltages at DM and DP to determine the type of device attached. With the MAX14630 or MAX14632 in Autodetection mode, when the voltage at DM is  $V_{DM1}$  or higher, and the voltage at DP is  $V_{DP}$  or lower, the voltage remains unchanged. If the voltage at DM is forced below the  $V_{DM1}$  threshold, the internal switch disconnects DM and DP from the resistor-divider, and DM and DP are shorted together for dedicated charging mode. Similarly, if the voltage at DP is forced higher than the  $V_{DP}$  threshold, the internal switch disconnects DM and DP from the resistor-divider, and DM and DP are shorted together for dedicated charging mode.

Once the charging voltage is removed, the short between DM and DP is disconnected.

**Table 1. Digital Input State for the MAX14630**

CB	MODE	STATUS
0	Autodetection 2A	Supports Apple 2A and USB BC compliant devices.
1	SS 2A	Supports Samsung Galaxy Tablet 2A and USB BC compliant devices.

**Table 2. Digital Input State for the MAX14632**

CB	MODE	STATUS
0	Autodetection 1A	Supports Apple 1A and USB BC compliant devices.
1	Autodetection 2A	Supports Apple 2A and USB BC compliant devices.

# MAX14630/MAX14632

## USB Charger Adapter Emulators

### Ordering Information

PART	TEMP RANGE	PIN-PACKAGE	TOP MARK	CB = 0/1
MAX14630EZK+T	-40°C to +85°C	5 TSOT	ADSM	Autodetection 2A/SS 2A
MAX14632EZK+T	-40°C to +85°C	5 TSOT	ADSN	Autodetection 1A/ Autodetection 2A

+Denotes a lead(Pb)-free/RoHS-compliant package.

T = Tape and reel.

### Chip Information

PROCESS: BiCMOS

### Package Information

For the latest package outline information and land patterns (footprints), go to [www.maximintegrated.com/packages](http://www.maximintegrated.com/packages). Note that a "+", "#", or "-" in the package code indicates RoHS status only. Package drawings may show a different suffix character, but the drawing pertains to the package regardless of RoHS status.

PACKAGE TYPE	PACKAGE CODE	OUTLINE NO.	LAND PATTERN NO.
5 TSOT	Z5+1	<a href="#">21-0113</a>	<a href="#">90-0241</a>