

# 5V/3.3V or Adjustable, High-Efficiency, Low-Dropout, Step-Down DC-DC Controllers

## General Description

The MAX1649/MAX1651 BiCMOS, step-down, DC-DC switching controllers provide high efficiency over loads ranging from 1mA to more than 2.5A. A unique, current-limited pulse-frequency-modulated (PFM) control scheme gives these devices the benefits of pulse-width-modulation (PWM) converters (high efficiency at heavy loads), while using only 100 $\mu$ A of supply current (vs. 2mA to 10mA for PWM converters). Dropout performance down to 300mV is provided by a high switch duty cycle (96.5%) and a low current-sense threshold (110mV).

A high switching frequency (up to 300kHz) allows these devices to use miniature external components.

The MAX1649/MAX1651 have dropout voltages less than 0.3V at 500mA and accept input voltages up to 16V. Output voltages are preset at 5V (MAX1649), or 3.3V (MAX1651). They can also be adjusted to any voltage from 1.5V to the input voltage by using two resistors.

These step-down controllers drive external P-channel MOSFETs at loads greater than 12.5W. If less power is required, use the MAX639/MAX640/MAX653 step-down converters with on-chip FETs, which allow up to a 225mA load current.

## Applications

PDA's  
High-Efficiency Step-Down Regulation  
5V-to-3.3V Green PC Applications  
Battery-Powered Applications

## Typical Operating Circuit



## Features

- ◆ More than 90% Efficiency (10mA to 1.5A Loads)
- ◆ More than 12.5W Output Power
- ◆ Less than 0.3V Dropout Voltage at 500mA
- ◆ 100 $\mu$ A Max Quiescent Supply Current
- ◆ 5 $\mu$ A Max Shutdown Supply Current
- ◆ 16V Max Input Voltage
- ◆ 5V (MAX1649), 3.3V (MAX1651), or Adjustable Output Voltage
- ◆ Current-Limited Control Scheme
- ◆ Up to 300kHz Switching Frequency
- ◆ Up to 96.5% Duty Cycle

## Ordering Information

PART	TEMP RANGE	PIN-PACKAGE
MAX1649CPA	0°C to +70°C	8 Plastic DIP
MAX1649CSA	0°C to +70°C	8 SO
MAX1649C/D	0°C to +70°C	Dice*
MAX1649EPA	-40°C to +85°C	8 Plastic DIP
MAX1649ESA	-40°C to +85°C	8 SO
MAX1651CPA	0°C to +70°C	8 Plastic DIP
MAX1651CSA	0°C to +70°C	8 SO
MAX1651C/D	0°C to +70°C	Dice*
MAX1651EPA	-40°C to +85°C	8 Plastic DIP
MAX1651ESA	-40°C to +85°C	8 SO

\*Dice are tested at  $T_A = +25^\circ\text{C}$ .

## Pin Configuration



# 5V/3.3V or Adjustable, High-Efficiency, Low-Dropout, Step-Down DC-DC Controllers

## ABSOLUTE MAXIMUM RATINGS

Supply Voltage, V+ to GND.....-0.3V, +17V  
 REF, SHDN, FB, CS, EXT, OUT.....-0.3V, (V+ + 0.3V)  
 Continuous Power Dissipation (T<sub>A</sub> = +70°C)  
 Plastic DIP (derate 9.09mW/°C above +70°C) .....727mW  
 SO (derate 5.88mW/°C above +70°C).....471mW

Operating Temperature Ranges  
 MAX1649C\_A, MAX1651C\_A .....0°C to +70°C  
 MAX1649E\_A, MAX1651E\_A.....-40°C to +85°C  
 Storage Temperature Range .....-65°C to +160°C  
 Lead Temperature (soldering, 10sec) .....+300°C

Stresses beyond those listed under "Absolute Maximum Ratings" may cause permanent damage to the device. These are stress ratings only, and functional operation of the device at these or any other conditions beyond those indicated in the operational sections of the specifications is not implied. Exposure to absolute maximum rating conditions for extended periods may affect device reliability.

## ELECTRICAL CHARACTERISTICS

(V+ = 5V, T<sub>A</sub> = T<sub>MIN</sub> to T<sub>MAX</sub>, unless otherwise noted. Typical values are at T<sub>A</sub> = +25°C.)

PARAMETER	SYMBOL	CONDITIONS	MIN	TYP	MAX	UNITS
V+ Input Voltage Range	V+	V <sub>OUT</sub> < V+	3.0		16	V
Supply Current	I+	V+ = 16V, SHDN ≤ 0.4V (operating, switch off)		78	100	μA
		V+ = 16V, SHDN ≥ 1.6V (shutdown)		2		
		V+ = 10V, SHDN ≥ 1.6V (shutdown)		1	5	
FB Trip Point		MAX1649C, MAX1651C	1.470	1.5	1.530	V
		MAX1649E, MAX1651E	1.4625	1.5	1.5375	
FB Input Current	I <sub>FB</sub>	MAX1649C, MAX1651C			±50	nA
		MAX1649E, MAX1651E			±70	
Output Voltage	V <sub>OUT</sub>	MAX1649, V+ = 5.5V to 16V	4.80	5.0	5.20	V
		MAX1651, V+ = 3.6V to 16V	3.17	3.3	3.43	
Reference Voltage	V <sub>REF</sub>	MAX1649C, MAX1651C, I <sub>REF</sub> = 0μA	1.470	1.5	1.530	V
		MAX1649E, MAX1651E, I <sub>REF</sub> = 0μA	1.4625	1.5	1.5375	
REF Load Regulation		0μA ≤ I <sub>REF</sub> ≤ 100μA, sourcing only		4	10	mV
REF Line Regulation		3V ≤ V+ ≤ 16V		40	100	μV/V
Output Voltage Line Regulation		Circuit of Figure 1	MAX1649, 5.5V ≤ V+ ≤ 16V, I <sub>LOAD</sub> = 1A	2.6		mV/V
			MAX1651, 3.6V ≤ V+ ≤ 16V, I <sub>LOAD</sub> = 1A	1.7		
Output Voltage Load Regulation		Circuit of Figure 1	MAX1649, 0A ≤ I <sub>LOAD</sub> ≤ 1.5A, V <sub>IN</sub> = 10V	-47		mV/A
			MAX1651, 0A ≤ I <sub>LOAD</sub> ≤ 1.5A, V <sub>IN</sub> = 5V	-45		
Efficiency		Circuit of Figure 1	MAX1649, V+ = 10V, I <sub>LOAD</sub> = 1A	90		%
			MAX1651, V+ = 5V, I <sub>LOAD</sub> = 1A	90		
SHDN Input Current		V+ = 16V, SHDN = 0V or V+			1	μA
SHDN Input Voltage High	V <sub>IH</sub>	3V ≤ V+ ≤ 16V	1.6			V
SHDN Input Voltage Low	V <sub>IL</sub>	3V ≤ V+ ≤ 16V			0.4	V

# 5V/3.3V or Adjustable, High-Efficiency, Low-Dropout, Step-Down DC-DC Controllers

MAX1649/MAX1651

## ELECTRICAL CHARACTERISTICS (continued)

( $V_+ = 5V$ ,  $T_A = T_{MIN}$  to  $T_{MAX}$ , unless otherwise noted. Typical values are at  $T_A = +25^\circ C$ .)

PARAMETER	SYMBOL	CONDITIONS	MIN	TYP	MAX	UNITS
Current-Limit Trip Level (V+ to CS)	$V_{CS}$	$3V \leq V_+ \leq 16V$	80	110	140	mV
CS Input Current		$3V \leq V_+ \leq 16V$			$\pm 1$	$\mu A$
Switch Maximum On-Time	$t_{ON}$ (max)	$V_+ = 12V$	24	32	40	$\mu s$
Switch Minimum Off-Time	$t_{OFF}$ (min)	$V_+ = 12V$	0.8	1.1	1.8	$\mu s$
EXT Rise Time		$C_{EXT} = 0.001\mu F$ , $V_+ = 12V$		25		ns
EXT Fall Time		$C_{EXT} = 0.001\mu F$ , $V_+ = 12V$		25		ns
Maximum Duty Cycle		$\frac{t_{ON}}{t_{ON} + t_{OFF}} \times 100\%$	95	96.5		%

## Typical Operating Characteristics

( $T_A = +25^\circ C$ , unless otherwise noted.)

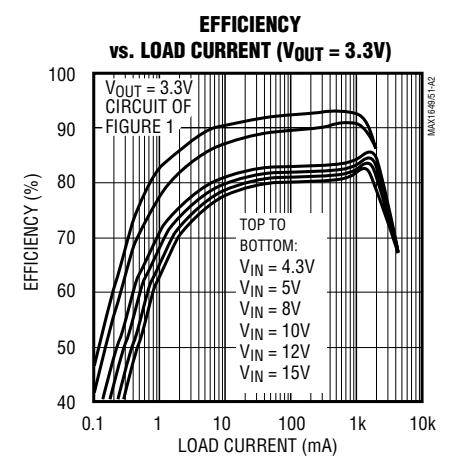
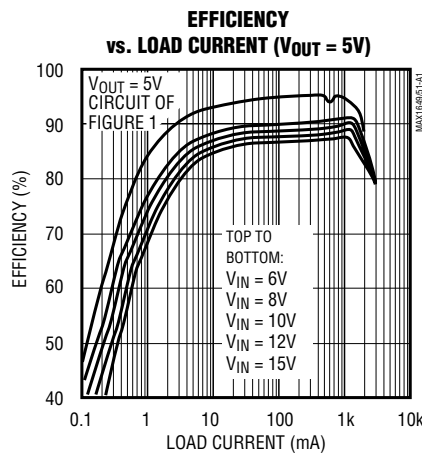

# 5V/3.3V or Adjustable, High-Efficiency, Low-Dropout, Step-Down DC-DC Controllers

## Typical Operating Characteristics (continued)

( $T_A = +25^\circ\text{C}$ , unless otherwise noted.)

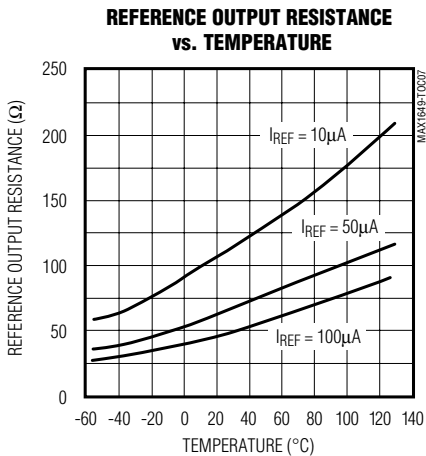
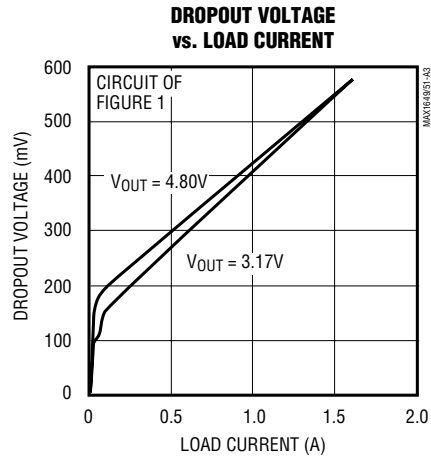
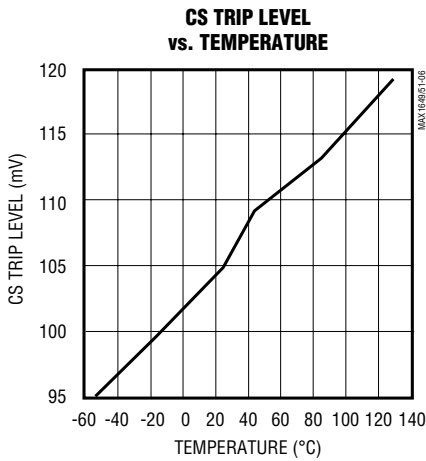
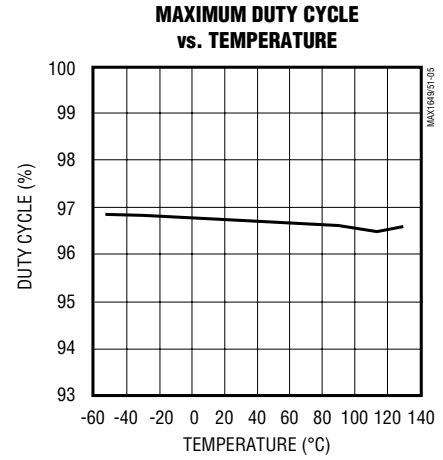
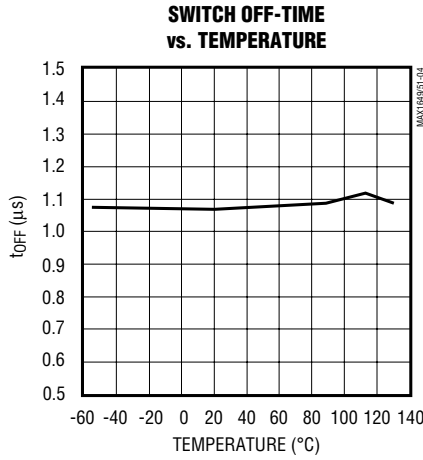
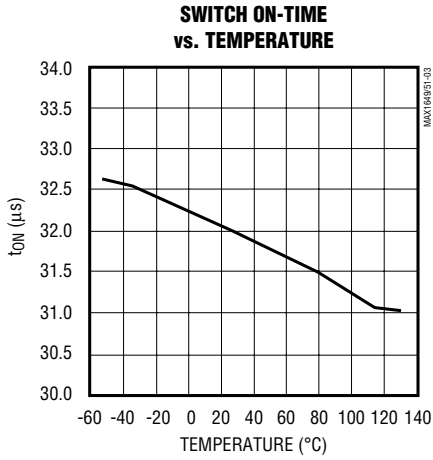

# 5V/3.3V or Adjustable, High-Efficiency, Low-Dropout, Step-Down DC-DC Controllers

## Typical Operating Characteristics (continued)

( $T_A = +25^\circ\text{C}$ , unless otherwise noted.)

**MAX1649  
LINE-TRANSIENT RESPONSE**



5ms/div

CIRCUIT OF FIGURE 1,  $I_{LOAD} = 1\text{A}$   
A:  $V_{OUT} = 5\text{V}$ , 100mV/div, AC-COUPLED  
B:  $V_+ = 6\text{V TO } 16\text{V}$ , 5V/div

**MAX1649  
LOAD-TRANSIENT RESPONSE**



200µs/div

CIRCUIT OF FIGURE 1,  $V_+ = 10\text{V}$   
A:  $V_{OUT} = 5\text{V}$ , 100mV/div, AC-COUPLED  
B:  $I_{LOAD} = 30\text{mA TO } 1.6\text{A}$ , 1A/div

**MAX1649  
SHDN RESPONSE TIME**



1ms/div

CIRCUIT OF FIGURE 1,  $V_+ = 10\text{V}$ ,  $I_{LOAD} = 1\text{A}$

MAX1649/MAX1651

# 5V/3.3V or Adjustable, High-Efficiency, Low-Dropout, Step-Down DC-DC Controllers

## Pin Description

PIN	NAME	FUNCTION
1	OUT	Sense Input for fixed 5V or 3.3V output operation. OUT is internally connected to the on-chip voltage divider. Although it is connected to the output of the circuit, OUT does not supply current. Leave OUT unconnected for adjustable-output operation.
2	FB	Feedback Input. Connect to GND for fixed-output operation. Connect a resistor divider between OUT, FB, and GND for adjustable-output operation. See <i>Setting the Output Voltage</i> section.
3	SHDN	Active-High Shutdown Input. Part is placed in shutdown when SHDN is driven high. In shutdown mode, the reference, output, and external MOSFET are turned off. Connect to GND for normal operation.
4	REF	1.5V Reference Output that can source 100 $\mu$ A. Bypass with 0.1 $\mu$ F.
5	V+	Positive Power-Supply Input
6	CS	Current-Sense Input. Connect current-sense resistor between V+ and CS. When the voltage across the resistor equals the current-limit trip level, the external MOSFET is turned off.
7	EXT	Gate Drive for External P-Channel MOSFET. EXT swings between V+ and GND.
8	GND	Ground



Figure 1. Typical Application Circuit

## Detailed Description

The MAX1649/MAX1651 are BiCMOS, step-down, switch-mode power-supply controllers that provide adjustable and fixed outputs of 5V and 3.3V, respectively. Their unique control scheme combines the advantages of pulse-frequency-modulation (low supply current) and pulse-width-modulation (high efficiency at high loads). An external P-channel power MOSFET allows peak currents in excess of 3A, increasing the output current capability over previous PFM devices. Figure 2 is the block diagram.

The MAX1649/MAX1651 offer four main improvements over prior solutions:

- 1) The converters operate with miniature surface-mount inductors, due to their 300kHz switching frequency.
- 2) The current-limited PFM control scheme allows greater than 90% efficiencies over a wide range of load currents (10mA to 1.5A).
- 3) Dropout voltage has been reduced to less than 300mV for many applications.
- 4) The quiescent supply current is only 100 $\mu$ A.

### PFM Control Scheme

The MAX1649/MAX1651 use a proprietary, current-limited PFM control scheme. As with traditional PFM converters, the external power MOSFET is turned on when the voltage comparator senses that the output is out of regulation. However, unlike traditional PFM converters, switching is accomplished through the combination of a peak current limit and a pair of one-shots that set the maximum switch on-time (32 $\mu$ s) and minimum switch off-time (1.1 $\mu$ s). Once off, the off-time one-shot holds the switch off for 1.1 $\mu$ s. After this minimum time, the switch either 1) stays off if the output is in regulation, or 2) turns on again if the output is out of regulation.

The MAX1649/MAX1651 also limit the peak inductor current, which allows them to run in continuous-conduction mode and maintain high efficiency with heavy loads (Figure 3). This current-limiting feature is a key component of the control circuitry. Once turned on, the switch stays on until either 1) the maximum on-time one-shot turns it off (32 $\mu$ s later), or 2) the current limit is reached.

EXT swings from V+ to GND and provides the drive output for an external P-channel power MOSFET.

# 5V/3.3V or Adjustable, High-Efficiency, Low-Dropout, Step-Down DC-DC Controllers

MAX1649/MAX1651



Figure 2. Block Diagram

## Shutdown Mode

When SHDN is high, the MAX1649/MAX1651 enter shutdown mode. In this mode, the internal biasing circuitry is turned off (including the reference) and the supply current drops to less than 5 $\mu$ A. EXT goes high, turning off the external MOSFET. SHDN is a logic-level input. Connect SHDN to GND for normal operation.

## Quiescent Current

In normal operation, the device's typical quiescent current is 78 $\mu$ A. In an actual application, even with no load, additional current is drawn to supply external feedback resistors (if used) and the diode and capacitor leakage currents. In the circuit of Figure 1, with V+ at 5V and VOUT at 3.3V, typical no-load supply current for the entire circuit is 90 $\mu$ A.

Dual Mode is a trademark of Maxim Integrated Products, Inc.



# 5V/3.3V or Adjustable, High-Efficiency, Low-Dropout, Step-Down DC-DC Controllers

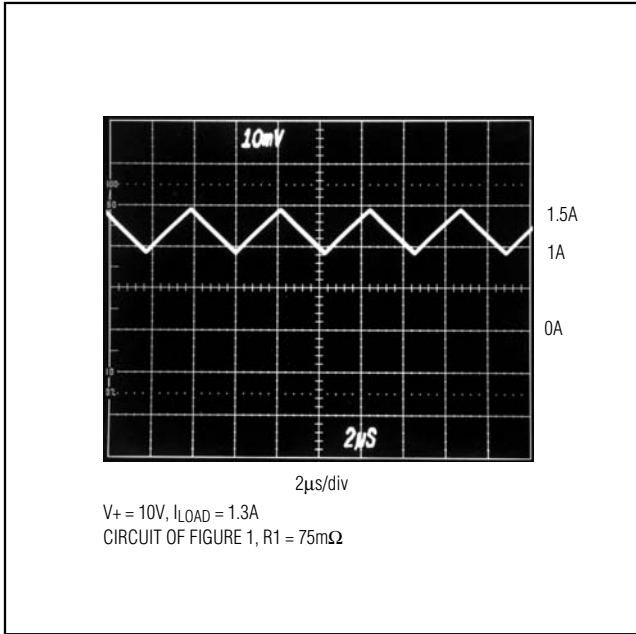

Figure 3. MAX1649 Continuous-Conduction Mode, Heavy Load-Current Waveform (500mA/div)

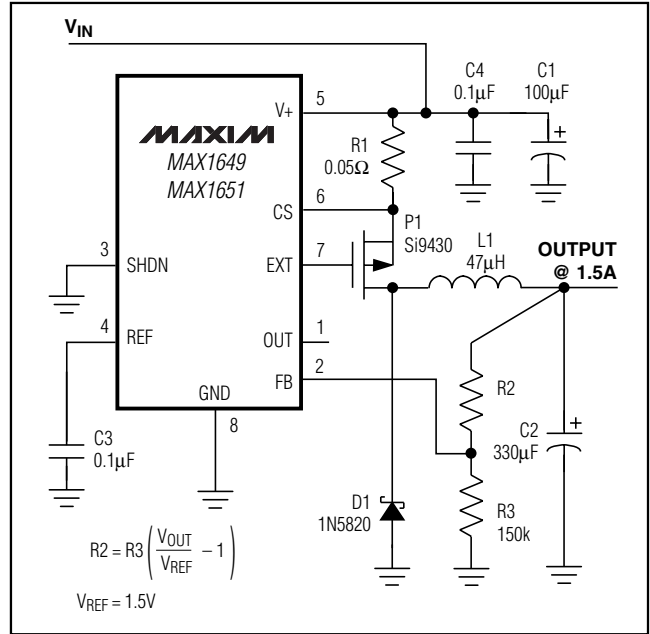

Figure 4. Adjustable-Output Operation

## Modes of Operation

When delivering high output currents, the MAX1649/MAX1651 operate in continuous-conduction mode. In this mode, current always flows in the inductor, and the control circuit adjusts the switch duty cycle to maintain regulation without exceeding the switch current capability (Figure 3). This provides excellent load-transient response and high efficiency.

In discontinuous-conduction mode, current through the inductor starts at zero, rises to a peak value, then ramps down to zero. Although efficiency is still excellent, the output ripple increases slightly, and the switch waveform exhibits ringing (at the inductor's self-resonant frequency). This ringing is to be expected and poses no operational problems.

## Dropout

The MAX1649/MAX1651 are in dropout when the input voltage ( $V_+$ ) is low enough that the output drops below the minimum output voltage specification (see *Electrical Characteristics*). The dropout voltage is the difference between the input and output voltage when dropout occurs. See the *Typical Operating Characteristics* for the Dropout Voltage vs. Load Current and Dropout Voltage vs. Temperature graphs.

## Design Procedure

### Setting the Output Voltage

The MAX1649/MAX1651 are preset for 5V and 3.3V output voltages, respectively; tie FB to GND for fixed-output operation. They may also be adjusted from 1.5V (the reference voltage) to the input voltage, using external resistors R2 and R3 configured as shown in Figure 4. For adjustable-output operation, 150kΩ is recommended for resistor R3—high enough to avoid wasting energy, yet low enough to avoid RC delays caused by parasitic capacitance at FB. R2 is given by:

$$R2 = R3 \times \left( \frac{V_{OUT}}{V_{REF}} - 1 \right)$$

where  $V_{REF} = 1.5V$ .

When using external resistors, it does no harm to connect OUT and the output together, or to leave OUT unconnected.

### Current-Sense Resistor Selection

The current-sense resistor limits the peak switch current to  $110mV/R_{SENSE}$ , where  $R_{SENSE}$  is the value of the current-sense resistor, and 110mV is the current-limit trip level (see *Electrical Characteristics*).



## 5V/3.3V or Adjustable, High-Efficiency, Low-Dropout, Step-Down DC-DC Controllers

To maximize efficiency and reduce the size and cost of external components, minimize the peak current. However, since the available output current is a function of the peak current, the peak current must not be too low.

To choose the proper current-sense resistor for a particular output voltage, determine the minimum input voltage and the maximum load current. Next, referring to Figures 5a or 5b, using the minimum input voltage, find the curve with the largest sense resistor that provides sufficient output current. It is not necessary to perform worst-case calculations. These curves take into account the sense-resistor ( $\pm 5\%$ ) and inductor ( $47\mu\text{H} \pm 10\%$ ) values, the diode drop (0.4), and the IC's current-sense trip level (85mV); an external MOSFET on-resistance of  $0.07\Omega$  is assumed for  $V_{GS} = -5\text{V}$ .

Standard wire-wound and metal-film resistors have an inductance high enough to degrade performance. Surface-mount (chip) resistors have very little inductance and are well suited for use as current-sense resistors. A U-shaped wire resistor made by IRC works well in through-hole applications. Because this resistor is a band of metal shaped as a "U", its inductance is less than 10nH (an order of magnitude less than metal film resistors). Resistance values between  $5\text{m}\Omega$  and  $0.1\Omega$  are available (see Table 1).

### Inductor Selection

The MAX1649/MAX1651 operate with a wide range of inductor values, although for most applications coils between  $10\mu\text{H}$  and  $68\mu\text{H}$  take best advantage of the con-

trollers' high switching frequency. With a high inductor value, the MAX1649/MAX1651 will begin continuous-current operation (see *Detailed Description*) at a lower fraction of full-load current. In general, smaller values produce higher ripple (see below) while larger values require larger size for a given current rating.

In both the continuous and discontinuous modes, the lower limit of the inductor is important. With a too-small inductor value, the current rises faster and overshoots the desired peak current limit because the current-limit comparator has a finite response time (300ns). This reduces efficiency and, more importantly, could cause the current rating of the external components to be exceeded. Calculate the minimum inductor value as follows:

$$L(\text{min}) = \frac{(V+(\text{max}) - V_{\text{OUT}}) \times 0.3\mu\text{s}}{\Delta I \times I_{\text{LIM}}}$$

where  $\Delta I$  is the inductor-current overshoot factor,  $I_{\text{LIM}} = V_{\text{CS}}/R_{\text{SENSE}}$ , and  $0.3\mu\text{s}$  is the time it takes the comparator to switch. Set  $\Delta I = 0.1$  for an overshoot of 10%.

For highest efficiency, use a coil with low DC resistance; a value smaller than  $0.1\text{V}/I_{\text{LIM}}$  works best. To minimize radiated noise, use a toroid, pot core, or shielded-bobbin inductor. Inductors with a ferrite core or equivalent are recommended. Make sure the inductor's saturation-current rating is greater than  $I_{\text{LIM}}(\text{max})$ . However, it is generally acceptable to bias the inductor into saturation by about 20% (the point where the inductance is 20% below its nominal value).



Figure 5a. MAX1649 Current-Sense Resistor Graph

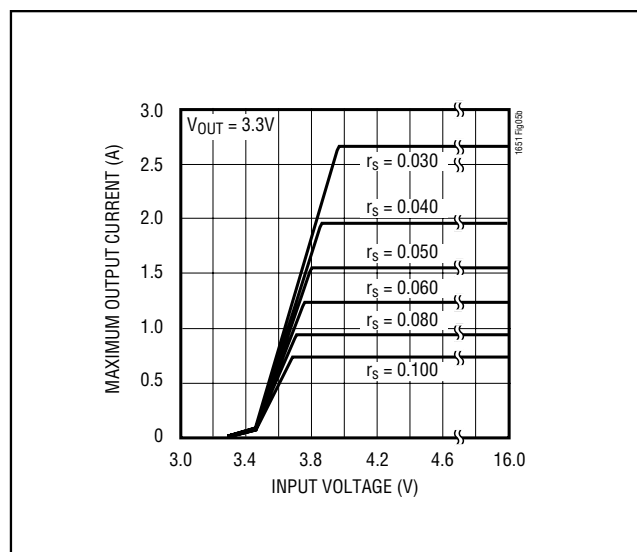

Figure 5b. MAX1651 Current-Sense Resistor Graph

# 5V/3.3V or Adjustable, High-Efficiency, Low-Dropout, Step-Down DC-DC Controllers

Table 1. Component Selection Guide

PRODUCTION METHOD	INDUCTORS	CAPACITORS	DIODES	CURRENT-SENSE RESISTORS	MOSFETS
Surface Mount	Sumida CDRH125-470 (1.8A) CDRH125-220 (2.2A)  Coilcraft DO3316-473 (1.6A) DO3340-473 (3.8A)	AVX TPS series  Sprague 595D series	Motorola MBRS340T3  Nihon NSQ series	Dale WSL Series  IRC LRC series	Siliconix Little Foot series  Motorola medium-power surface-mount products
Miniature Through-Hole	Sumida RCH875-470M (1.3A)	Sanyo OS-CON series low-ESR organic semiconductor		IRC OAR series	Motorola
Low-Cost Through-Hole	Coilcraft PCH-45-473 (3.4A)	Nichicon PL series low-ESR electrolytics  United Chemi-Con LXF series	Motorola 1N5817 to 1N5823		Motorola TMOS power MOSFETs

The peak current of Figure 1 is 2.35A for a 1.5A output. The inductor used in this circuit is specified to drop by 10% at 2.2A (worst case); a curve provided by the manufacturer shows that the inductance typically drops by 20% at 2.7A. Using a slightly underrated inductor can sometimes reduce size and cost, with only a minor impact on efficiency.

Table 1 lists inductor types and suppliers for various applications. The efficiencies of the listed surface-mount inductors are nearly equivalent to those of the larger size through-hole versions.

### Diode Selection

The MAX1649/MAX1651's high switching frequency demands a high-speed rectifier. Schottky diodes, such as the 1N5817 through 1N5823 (and their surface-mount equivalents), are recommended. Choose a diode with an average current rating equal to or greater than  $I_{LIM(max)}$  and a voltage rating higher than  $V_{+}(max)$ .

### External Switching Transistor

The MAX1649/MAX1651 drive P-channel enhancement-mode MOSFET transistors only. The choice of power transistor is primarily dictated by the input voltage and the peak current. The transistor's on-resistance, gate-source threshold, and gate charge must also be appropriately chosen. The drain-to-source and gate-to-source breakdown voltage ratings must be greater than  $V_{+}$ . The total gate-charge specification is normally not

critical, but values should be less than 100nC for best efficiency. The MOSFET should be capable of handling the peak current and, for maximum efficiency, have a very low on-resistance at that current. Also, the on-resistance must be low for the minimum available  $V_{GS}$ , which equals  $V_{+}(min)$ . Select a transistor with an on-resistance between 50% and 100% of the current-sense resistor. The Si9430 transistor chosen for the *Typical Operating Circuit* has a drain-to-source rating of -20V and a typical on-resistance of  $0.070\Omega$  at 2A with  $V_{GS} = -4.5V$ . Tables 1 and 2 list suppliers of switching transistors suitable for use with these devices.

### Capacitor Selection

#### Output Filter Capacitor

The primary criterion for selecting the output filter capacitor is low equivalent series resistance (ESR), rather than high capacitance. An electrolytic capacitor with low enough ESR will automatically have high enough capacitance. The product of the inductor-current variation and the output filter capacitor's ESR determines the amplitude of the high-frequency ripple seen on the output voltage. When a  $330\mu F$ , 10V Sprague surface-mount capacitor (595D series) with  $ESR = 0.15\Omega$  is used, 40mV of output ripple is typically observed when stepping down from 10V to 5V at 1A. The output filter capacitor's ESR also affects efficiency. Again, low-ESR capacitors perform best. Table 1 lists some suppliers of low-ESR capacitors.

# 5V/3.3V or Adjustable, High-Efficiency, Low-Dropout, Step-Down DC-DC Controllers

**MAX1649/MAX1651**

**Table 2. Component Suppliers**

COMPANY		PHONE	FAX
AVX	USA	(207) 282-5111 or (800) 282-4975	(207) 283-1941
Coiltronics	USA	(516) 241-7876	(516) 241-9339
Coilcraft	USA	(708) 639-6400	(708) 639-1469
Dale	USA	(402) 564-3131	(402) 563-1841
International Rectifier	USA	(310) 322-3331	(310) 322-3332
IRC	USA	(512) 992-7900	(512) 992-3377
Motorola	USA	(602) 244-3576 or (602) 244-5303	(602) 244-4015
Nichicon	USA Japan	(708) 843-7500 81-7-5231-8461	(708) 843-2798 81-7-5256-4158
Nihon	USA Japan	(805) 867-2555 81-3-3494-7411	(805) 867-2556 81-3-3494-7414
Sanyo	USA Japan	(619) 661-6835 81-7-2070-6306	(619) 661-1055 81-7-2070-1174
Siliconix	USA	(408) 988-8000 or (800) 554-5565	(408) 970-3950
Sprague	USA	(603) 224-1961	(603) 224-1430
Sumida	USA Japan	(708) 956-0666 81-3-3607-5111	(708) 956-0702 81-3-3607-5144
United Chemi-Con	USA	(714) 255-9500	(714) 255-9400

### Input Bypass Capacitor

The input bypass capacitor reduces peak currents drawn from the voltage source, and also reduces the amount of noise at the voltage source caused by the switching action of the MAX1649/MAX1651. The input voltage source impedance determines the size of the capacitor required at the V+ input. As with the output filter capacitor, a low-ESR capacitor is recommended. Bypass the IC separately with a 0.1µF ceramic capacitor placed close to the V+ and GND pins.

### Reference Capacitor

Bypass REF with a 0.1µF or larger capacitor.

### Package Information

For the latest package outline information and land patterns, go to [www.maxim-ic.com/packages](http://www.maxim-ic.com/packages).

PACKAGE TYPE	PACKAGE CODE	DOCUMENT NO.
8 PDIP	P8-2	<a href="#">21-0041</a>
8 SO	S8-4	<a href="#">21-0043</a>

### Layout Considerations

Proper PC board layout is essential because of high current levels and fast switching waveforms that radiate noise. Minimize ground noise by connecting the anode of the rectifier, the input bypass capacitor ground lead, and the output filter capacitor ground lead to a single point ("star" ground configuration). A ground plane is recommended. Also minimize lead lengths to reduce stray capacitance, trace resistance, and radiated noise. In particular, the traces connected to FB (if an external resistor divider is used) and EXT must be short. Place the 0.1µF ceramic bypass capacitor as close as possible to the V+ and GND pins.

### MAX1649/MAX1651 vs. MAX649/MAX651

The MAX1649 and MAX1651 are pin compatible with the MAX649 and MAX651, but have been optimized for improved dropout performance and efficiency—particularly with low input voltages. The MAX1649/MAX1651 feature increased maximum switch duty cycle (96.5%) and reduced current-limit sense voltage (110mV). Their predecessors, the MAX649/MAX651, use a higher two-step (210mV/110mV) current-limit sense voltage to provide tighter current-sense accuracy and reduced inductor peak current at light loads.

### Chip Topography



TRANSISTOR COUNT: 428  
SUBSTRATE CONNECTED TO V+