

MAX20328/MAX20328A/ MAX20328B

MUX Switch for USB Type-C Audio Adapter Accessories

General Description

The MAX20328/MAX20328A/MAX20328B are USB Type-C audio interface ICs for use in portable devices. As USB Type-C and USB power delivery (PD) make a high-voltage charging solution readily available, the data and SBU lines are at risk of shorting to a high bus voltage, risking permanent damage to the portable device. USB 2.0 data lines also need protection when multiplexed with analog audio signals that vary from positive to negative voltages. The devices can detect a CC pin connection event to disable the microphone bias and eliminate pop up noise when an audio accessory is attached.

The MAX20328/MAX20328A/MAX20328B come in a 5 x 5 array, 25-bump, 0.4mm pitch, 2.31mm x 2.31mm wafer-level package (WLP).

Applications

- Smart Phones
- Phablets
- Tablet PCs

Benefits and Features

- Versatile and Flexible Switch Configurations
 - High-Speed USB Data or Audio Switch Paths
 - Automatic Impedance Detection in Audio Configurations
 - Full Manual Switch Control
 - Beyond-the-Rails™ Signal Capability
- Overvoltage Protected Data and Audio Channels
 - Two Separate OVLO Blocks
 - OVLO Threshold Programmable to 3.37V, 4.00V, 4.70V, or 5.00V
- Negative Voltage Capable Audio Channel
 - ±5V Audio Signals (Limited by Positive OVLO Threshold)
 - -100dB THD+N
 - -100dB PSRR at 217Hz
- High ESD and Surge-Protected USB Type-C Contacts
 - ±12kV HBM
 - ±25V Surge Capable on USB Type-C Pins
- Minimal Solution size
 - 5 x 5 Array, 0.4mm Pitch 2.31mm x 2.31mm WLP

Ordering Information appears at end of data sheet.

Beyond-the-Rails is a trademark of Maxim Integrated Products, Inc.

Absolute Maximum Ratings (Note 2)

All voltages are referenced to AGND unless otherwise noted

V_{CC}, MIC, SDA, SCL -0.3 to +6V
 DGND -0.3 to +0.3V
 CC -0.3 to +26V
 SBU1_MG, SBU2_GM, MG_SR,
 GM_SR (Note 1)..... -0.3 to +12V
 MG_SL, GM_SL (MAX20328 Only) (Note 1) -0.3 to +12V
 DP_T, DM_T, DP_B, DM_B (Note 1) -6 to min
 [(LA + 12V, RA + 12V), +12V]
 DP_AP1, DM_AP1, DP_AP2, DM_AP2 -0.3 to +6V
 LA, RA -6 to +6V
 GSNS_L (MAX20328 only) -0.3 to min
 [+6V, (MG_SL + 0.3V, GM_SL + 0.3V)].

GSNS_R (MAX20328 only)..... -0.3 to min
 [+6V, (MG_SR + 0.3V, GM_SR + 0.3V)]
 GSNS_ (MAX20328A/MAX20328B only)..... -0.3 to min
 [+6V, (MG_SR + 0.3V, GM_SR + 0.3V)]
 TX, RX, INT (MAX20328A/MAX20328B only) -0.3 to +6V
 Continuous Current Into Any Pin..... ±200mA
 Continuous Power Dissipation (Multilayer Board)
 (Derate 19.07mW/°C above +70°C)..... 1525.6mW
 Operating Temperature Range..... -40°C to +85°C
 Junction Temperature..... +150°C
 Storage Temperature Range -65°C to +150°C
 Soldering Temperature (Reflow)..... +260°C

Note 1: Surge capable up to ±25V (IEC61000-4-5 Connector Class 0)

Package Information

PACKAGE TYPE: 25 WLP	
Package Code	W252R2+1
Outline Number	21-100208
Land Pattern Number	Refer to Application Note 1891
THERMAL RESISTANCE	
Junction-to-Ambient Thermal Resistance, Four-Layer Board (θ _{JA})	52.43°C/W

Package thermal resistances were obtained using the method described in JEDEC specification JESD51-7, using a four-layer board. For detailed information on package thermal considerations, refer to www.maximintegrated.com/thermal-tutorial.

For the latest package outline information and land patterns (footprints), go to www.maximintegrated.com/packages. Note that a “+”, “#”, or “-” in the package code indicates RoHS status only. Package drawings may show a different suffix character, but the drawing pertains to the package regardless of RoHS status.

Electrical Characteristics

($V_{CC} = 2.7V$ to $5.5V$, $T_A = -40^{\circ}C$ to $+85^{\circ}C$ unless otherwise noted. Typical values are at $V_{CC} = +3.7V$, $T_A = +25^{\circ}C$) (Note 2)

PARAMETER	SYMBOL	CONDITIONS	MIN	TYP	MAX	UNITS	
VCC							
Supply Voltage Range	V_{CC}		2.7		5.5	V	
Input Supply Current	I_{CC}	$V_{CC} = 3.7V$		256	400	μA	
OVLO Shutdown Current	I_{CC_O}	$V_{DP_DM_} = 6V$, $V_{LA/RA} = V_{DP_DM_AP_} = 0V$		256	400	μA	
Shutdown Current	I_{CC_SHDN}	$V_{CC} = 3.7V$, $EN = 0$		3.9	7	μA	
Undervoltage Lockout (POR) Rising Threshold	V_{UVLOR}			2.395		V	
Undervoltage Lockout (POR) Falling Threshold	V_{UVLOF}			2.365		V	
Undervoltage Lockout (POR) Threshold Hysteresis	V_{UVLOH}			30		mV	
Start-up Delay	t_{START}	From (V_{CC} rising crosses V_{UVLOR} OR EN from 0 to 1) to EOB rising from 0 to 1		0.85	2	ms	
OVERVOLTAGE PROTECTION DP/M_, SBU_, MG_S, GM_S							
Overvoltage Trip Level	V_{OVLO}	V_{IN} Rising (Note 3)	SET_OVTH[1:0] = 00	3.220	3.37	3.520	V
			SET_OVTH[1:0] = 01	3.845	4.0	4.155	
			SET_OVTH[1:0] = 10	4.535	4.7	4.865	
			SET_OVTH[1:0] = 11	4.830	5.0	5.170	
Overvoltage Trip Level Hysteresis	V_{OVLOH}			60		mV	
Overvoltage Fault Protection Response Time	t_{FP}	$V_{IN} = 1V$ to $10V$ step, $V_{CC} = 3.7V$, $R_L = 50\Omega$		100		ns	
DP/DM Overvoltage Fault Protection Recovery Time	t_{FPR}	$V_{IN} = 10V$ to $1V$ step, $V_{CC} = 3.7V$, $R_L = 50\Omega$		10		ms	
DP_, DM_ (DATA AND AUDIO SWITCHES)							
Analog Signal Range Audio	$V_{DP_DM_}$		-5		V_{OVLO}	V	
Analog Signal Range Data	$V_{DP_DM_}$		0		V_{OVLO}	V	
Single Channel On Resistance	$R_{ON-DP_DM_}$	$V_{CC} = 3.7V$, $T_A = +25^{\circ}C$		2.24	4	Ω	
On Resistance Match Between Channels	$\Delta R_{ON-DP_DM_}$	$V_{CC} = 3.7V$, $V_{DP/M_} = 0V$, $I_{D_} = 10mA$ (Note 4)		0.02	0.21	Ω	
On Resistance Flatness	$R_{FLAT-DP_DM_}$	$V_{CC} = 3.7V$, $I_{DP_DM_} = 10mA$, $V_{DP_DM_} = -1.0V$ to $+1.0V$ (Note 5)		0.00005	0.02	Ω	

Electrical Characteristics (continued)

($V_{CC} = 2.7V$ to $5.5V$, $T_A = -40^{\circ}C$ to $+85^{\circ}C$ unless otherwise noted. Typical values are at $V_{CC} = +3.7V$, $T_A = +25^{\circ}C$) (Note 2)

PARAMETER	SYMBOL	CONDITIONS	MIN	TYP	MAX	UNITS
Off Leakage Current	$I_{DP_DM_OFF}$	$V_{CC} = 3.7V$, $EN = 0$, $V_{DP_DM_} = 2.5V$, $V_{LA/RA} = V_{DP_AP_DM_AP_} = 0V$	-0.5	+0.5	+1.5	μA
On Leakage Current	$I_{DP_DM_ON}$	Data Channel Closed $V_{CC} = 3.7V$, $EN = 1$, $V_{DP_DM_} = 2.5V$, $V_{DP_AP_DM_AP_} = \text{Floating}$ $V_{LA/RA} = 0V$	-0.7	+0.4	+1.5	μA
	I_{LA/RA_ON}	Audio Channel Closed $V_{CC} = 3.7V$, $EN = 1$, $V_{LA/RA} = 2.5V$, $V_{DP_DM_} = \text{Floating}$ $V_{DP_AP_DM_AP_} = 0V$	-0.5	+0.8	+2.1	
Turn-On Time	$t_{ON-DP_DM_}$	$V_{DP_DM_} = 1.5V$, $R_L = 50\Omega$, I ² C control, time from last data bit processed to 90% of final value		50		μs
Turn-Off Time	$t_{OFF-DP_DM_}$	$V_{DP_DM_} = 1.5V$, $R_L = 50\Omega$, I ² C control, time from last data bit processed to 10% of initial value		5		μs
Output Skew Same Switch	t_{SKSS}	(Note 6)		40		ps
Output Skew Between Switches	t_{SKBS}	(Note 6)		40		ps
Break-Before-Make Time Delay	t_{BBM}	$R_L = 50\Omega$, Time delay between one side of the mux switch opening and the other side closing.		10		μs
Bandwidth	$BW_{DP_DM_}$	$BW_{DP_DM_} = 0dBm$, $R_S = R_L = 50\Omega$		800		MHz
Off Isolation	$V_{ISO-DP_DM_}$	$f = 20Hz$ to $20kHz$, $V_{D_} = 400V_{PK-PK}$, $R_L = 50\Omega$		-90		dB
Crosstalk (Note 7)	$V_{CT-DP_DM_}$	$f = 20Hz$ to $20kHz$, $V_{D_} = 400V_{PK-PK}$, $R_L = 50\Omega$		-80		dB
THD+N	$THD_{DP_DM_}$	$f = 20Hz$ to $20kHz$, $V_{D_} = 1V_{PK-PK}$, DC bias = $0V$, $R_L = 32, 600\Omega$		-100		dB
PSRR	$PSRR_{DP_DM_}$	$V_{CC} = 3.7V$, $V = 400mV_{PK-PK}$, $f = 217Hz$, $R_S = R_L = 50\Omega$		-110		dB

Electrical Characteristics (continued)

($V_{CC} = 2.7V$ to $5.5V$, $T_A = -40^{\circ}C$ to $+85^{\circ}C$ unless otherwise noted. Typical values are at $V_{CC} = +3.7V$, $T_A = +25^{\circ}C$) (Note 2)

PARAMETER	SYMBOL	CONDITIONS	MIN	TYP	MAX	UNITS
L _{AUDIO} Current Source	I _{LA_SRC}	MANUAL_IDET = 1, SET_IDET = 01	95	100	105	μA
		MANUAL_IDET = 1, SET_IDET = 10	1.05	1.1	1.15	mA
		MANUAL_IDET = 1, SET_IDET = 11	5.25	5.5	5.75	
L _{AUDIO} Current Source Ramp Up/Down Time	t _{RAMP}		43.75	50	56.25	ms
MIC Bias Detection Threshold	MIC _{THR}	V _{CC} = 3.7V, V _{MIC} rising	450	788	1150	mV
	MIC _{THF}	V _{CC} = 3.7V, V _{MIC} falling	350	701	1100	
	MIC _{TH_HYST}	V _{CC} = 3.7V		87		
Total Detection Time	t _{DET}	3 ramps max detection time		600		ms
CC						
CC Disconnect Detection Threshold	V _{CC_DD_TH}	Audio Accessory mode, Rising	0.5		1.4	V
Leakage Current	I _{L_CC}	CC = 5V	-1		+1	μA
Time to MIC Open and SBU ₋ Discharge Time From CC High	t _{CC_MIC_DIS}	C _{SBU_-} < 2μF		7		μs
SBU TO GROUND (GND SWITCH)						
Analog Signal Range	V _{SBU_G}		-0.3		V _{OVLO}	V
On-Resistance	R _{ON-SBU_G}	V _{CC} = 3.7V, I = 100mA		80	150	mΩ
PSRR	P _{SRRSBU_G}	V _{CC} = 3.7V, V _{SBU_-} = 400mV _{PK-PK} , f = 217Hz, R _S = R _L = 50Ω		-120		dB
SBU TO MIC (MIC SWITCH)						
Analog Signal Range	V _{SBU_MIC}		0		V _{OVLO}	V
On Resistance	R _{ON-SBU_MIC}	V _{CC} = 3.7V, I = 100mA		1.7	2.9	Ω
Turn-On Time	t _{ON-SBU_MIC}	V _{SBU_-} = 1.5V, R _L = 50Ω, I ² C Control, time from last data bit processed to 90% of final value		20		μs
Turn-Off Time	t _{OFF-SBU_MIC}	V _{SBU_-} = 1.5V, R _L = 50Ω, I ² C Control, time from last data bit processed to 10% of initial value		5		μs
Bandwidth	BW _{SBU_MIC}	V _{SBU_-} = 0dBm, R _S = R _L = 50Ω		30		MHz

Electrical Characteristics (continued)

($V_{CC} = 2.7V$ to $5.5V$, $T_A = -40^{\circ}C$ to $+85^{\circ}C$ unless otherwise noted. Typical values are at $V_{CC} = +3.7V$, $T_A = +25^{\circ}C$) (Note 2)

PARAMETER	SYMBOL	CONDITIONS	MIN	TYP	MAX	UNITS
THD+N	THD _{SBU_MIC}	500mV _{PK-PK} , DC bias = 2V with 2.2k Ω to MIC, f = 20Hz – 20kHz, R _L = 600 Ω		100		dB
PSRR	PSRR _{SBU_MIC}	V _{CC} = 3.7V, V _{SBU} = 400mV _{PK-PK} , f = 217Hz, R _S = R _{SL} = 50 Ω		-110		dB
Off Isolation	V _{ISO-SBU_MIC}	V _D = 400mV _{PK-PK} , f = 20kHz, R _L = 50 Ω		-100		dB
GROUND SENSE AND UART SWITCHES (GM_SR, GM_SL, MG_SR, MG_SL, TX, RX)						
Analog Signal Range	V _{GM/MG}	Ground sense switches	-0.3		+2.5	V
	V _{UART}	UART switches	-0.3		V _{OVLO}	
On Resistance	R _{ON-GSNS}	Ground Sense, V _{GM/MG} = 0V, I _{LOAD} = 100mA		1.8	3	Ω
	R _{ON-UART}	UART, I _{LOAD} = 10mA		6.5	11.5	
Turn-On Time	t _{ON-GSNS}	V _{COM} = 1.5V, R _L = 50 Ω , I ² C control		45		μ s
	t _{ON-UART}	V _{COM} = 1.5V, R _L = 50 Ω , I ² C control		20		
Turn-Off Time	t _{OFF-GSNS/UART}	V _{COM} = 1.5V, R _L = 50 Ω , OVLO event or I ² C control		5		μ s
Bandwidth	BW _{GSNS}	R _S = R _L = 50 Ω , C _L = 10pF		300		MHz
Crosstalk	V _{CT-GSNS}	V _{CC} = 3.7V, R _S = R _L = 50 Ω , f = 20kHz		-100		dB
Off Isolation	V _{ISO-GSNS}	f = 20kHz, V _D = 400mV _{PK-PK} , R _L = 50 Ω		-100		dB
THD+N	THD _{GSNS}	V _{CC} = 3.7V, 10mV _{PK-PK} , DC bias = 0V, f = 20Hz – 20kHz, R _S = 50 Ω , R _L = 200 Ω		0.0004		%
PSRR	PSRR _{GSNS}	V = 400mV _{PK-PK} , f = 217Hz, R _S = R _L = 50 Ω		-120		dB
DIGITAL SIGNALS (SCL, SDA, INT, MAX20328A/MAX20328B ONLY)						
Output Voltage Low	V _{OL}	I _{SDA} = 4mA			0.4	V
Output Leakage	I _{LEAK}	V _{SDA} = 5.5V	-1		1	μ A
Input Voltage High	V _{IH}		1.4			V
Input Voltage Low	V _{IL}				0.5	V
SCL Clock Frequency	f _{SCL}				400	kHz

Electrical Characteristics (continued)

($V_{CC} = 2.7V$ to $5.5V$, $T_A = -40^{\circ}C$ to $+85^{\circ}C$ unless otherwise noted. Typical values are at $V_{CC} = +3.7V$, $T_A = +25^{\circ}C$) (Note 2)

PARAMETER	SYMBOL	CONDITIONS	MIN	TYP	MAX	UNITS
Bus Free Time Between a STOP and START Condition	t_{BUF}		1.3			μs
START Condition (Repeated) Hold Time	$t_{HD:STA}$		0.6			μs
Low Period of SCL Clock	t_{LOW}		1.3			μs
High Period of SCL Clock	t_{HIGH}		0.6			μs
Setup Time for a Repeated START Condition	$t_{SU:STA}$		0.6			μs
Data Hold Time	$t_{HD:DAT}$		0		0.9	μs
Data Setup Time	$t_{SU:DAT}$		100			μs
Setup Time for a STOP Condition	$t_{SU:STO}$		0.6			μs
Spike Pulse Widths Suppressed by Input Filter	t_{SP}			50		ns
THERMAL PROTECTION						
Thermal Shutdown	T_{SHDN}			135		
Thermal Hysteresis	T_{HYST}			20		
ESD PROTECTION						
HBM		DP_T, DM_T, DP_B, DM_B, SBU1_MG, SBU2_GM, MG_SL, MG_SR, GM_SL, GM_SR	±12			kV
Surge			±25			V
HBM		All other pins	±2			kV

Note 2: All devices are 100% production tested at $T_A = +25^{\circ}C$. All temperature limits are guaranteed by design.

Note 3: The switch turns off for voltages above V_{OVLO} , protecting downstream circuits in case a fault condition occurs.

Note 4: $\Delta R_{ON}(MAX) = ABS(R_{ON_CH1} - R_{ON_CH2})$.

Note 5: Flatness is defined as the difference between the maximum and minimum value of on-resistance, as measured over the specified analog signal range.

Note 6: Guaranteed by design.

Note 7: Between two switches.

Typical Operating Characteristics

($V_{CC} = 3.7V$, $T_A = +25^\circ C$ unless otherwise noted.)

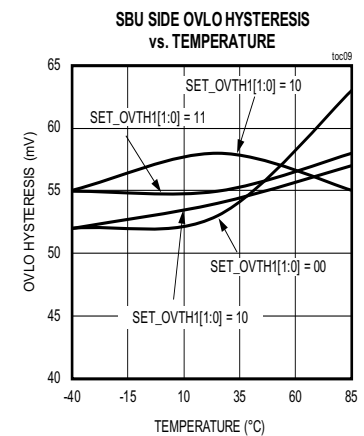
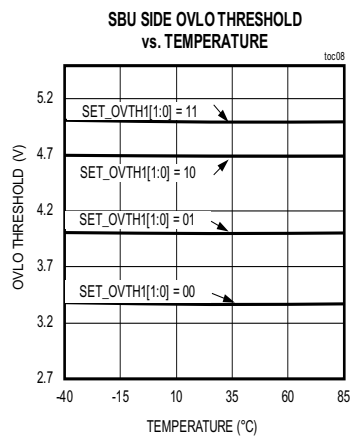
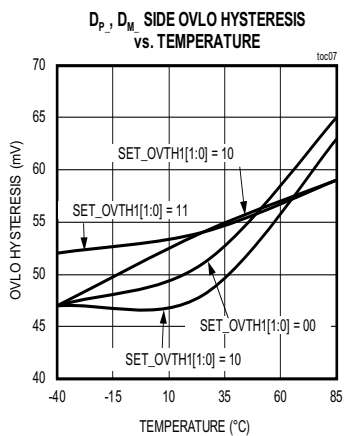
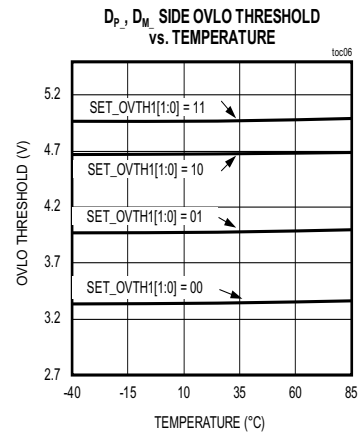
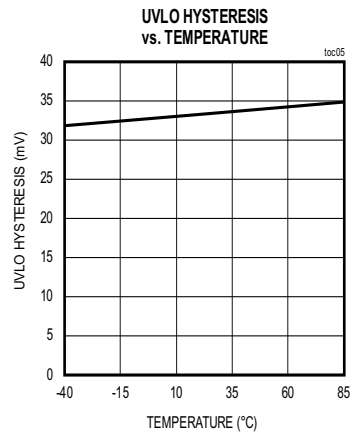
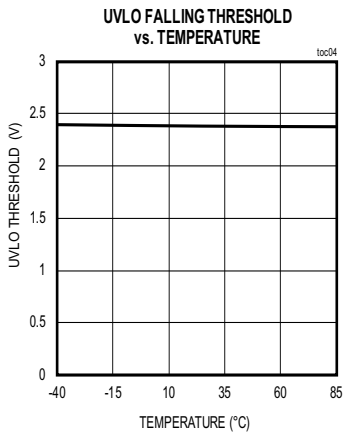
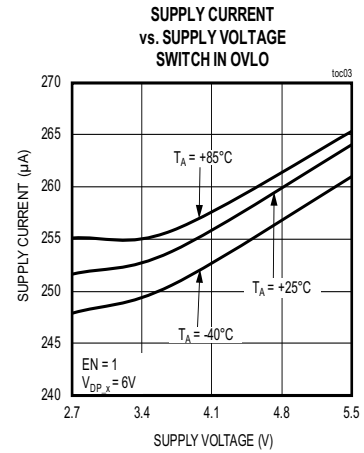
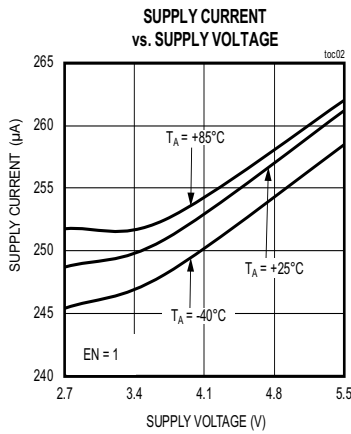
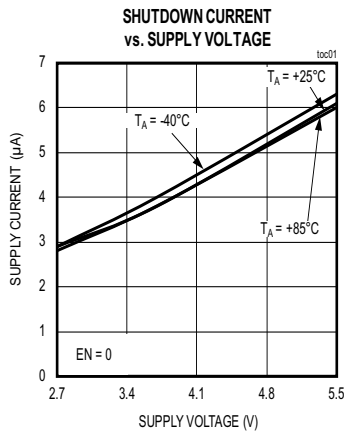

Typical Operating Characteristics (continued)

($V_{CC} = 3.7V$, $T_A = +25^\circ C$ unless otherwise noted.)

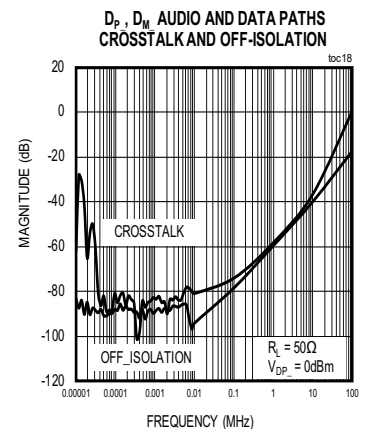
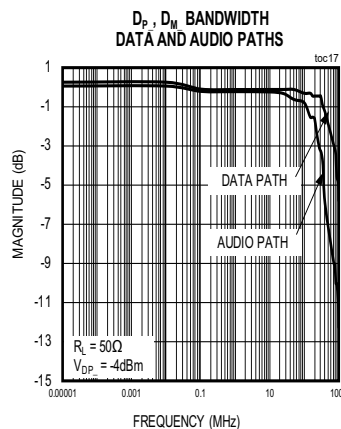
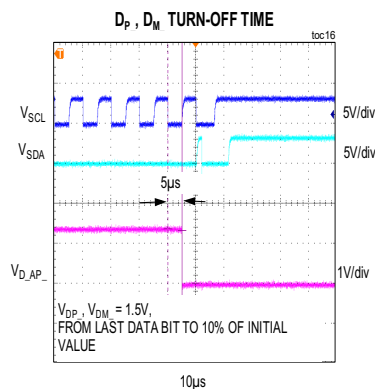
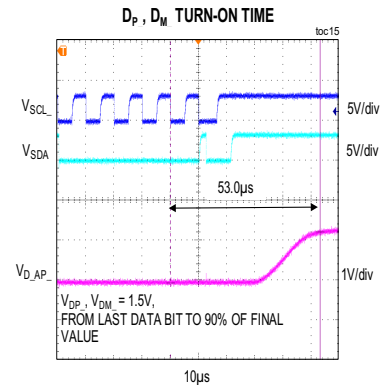
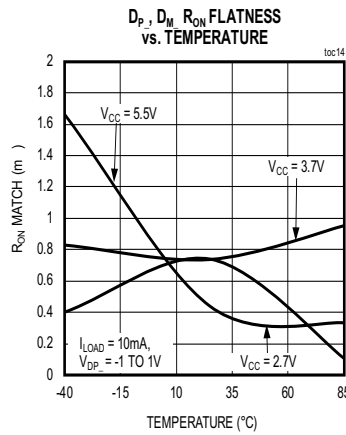
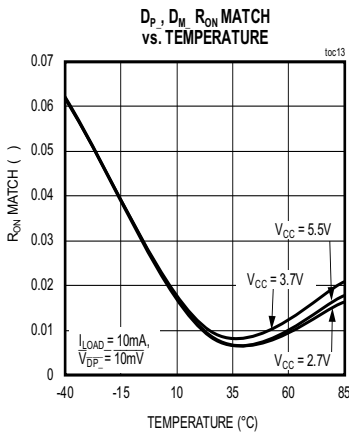
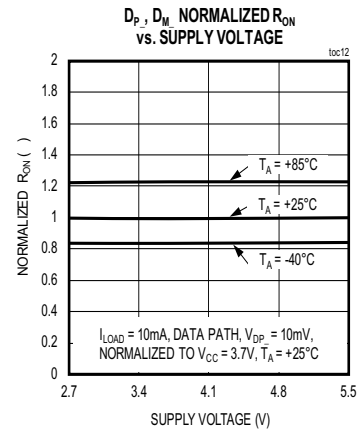
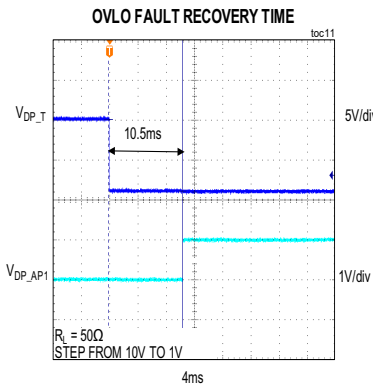
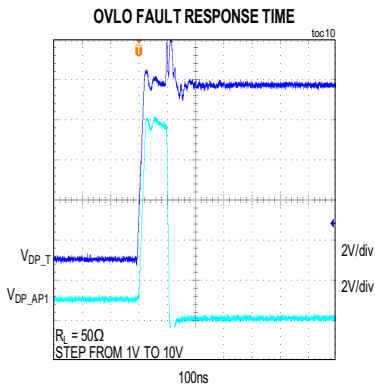

Typical Operating Characteristics (continued)

($V_{CC} = 3.7V$, $T_A = +25^\circ C$ unless otherwise noted.)

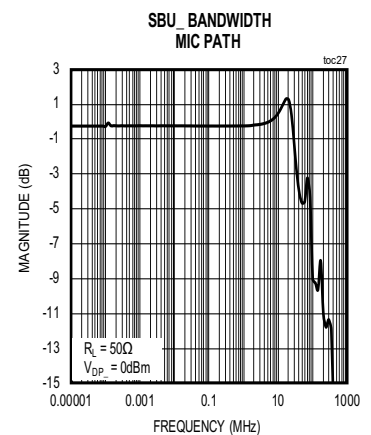
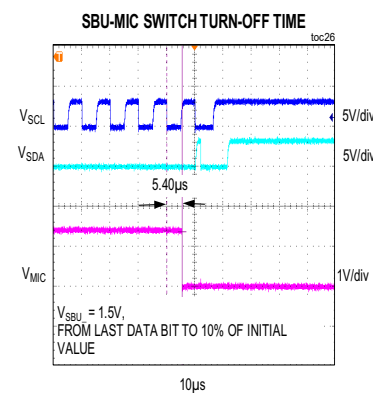
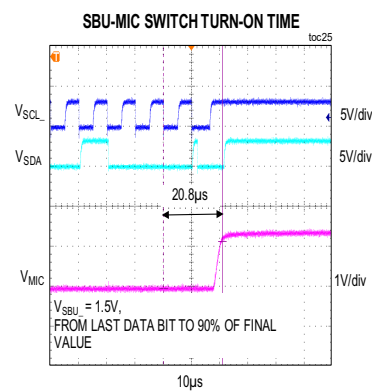
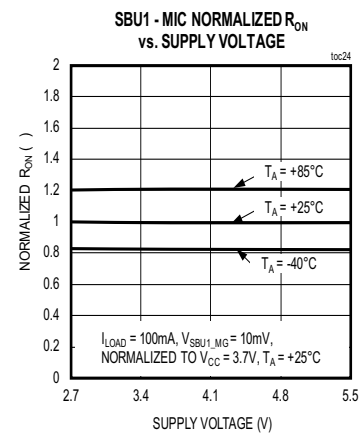
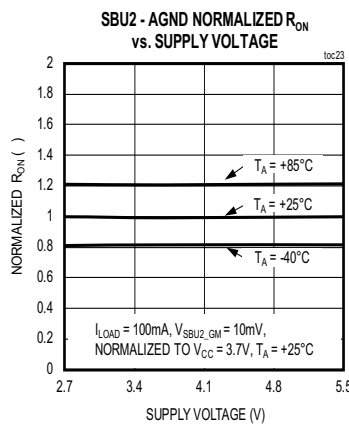
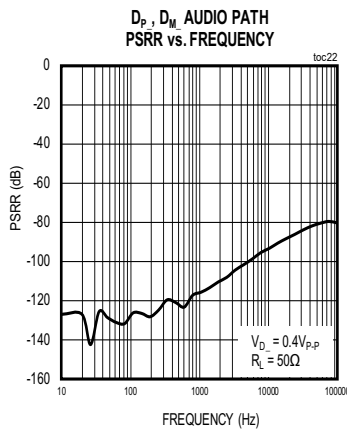
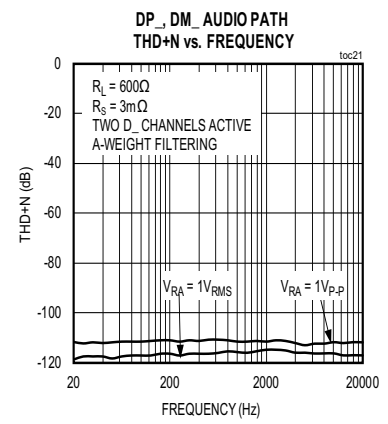
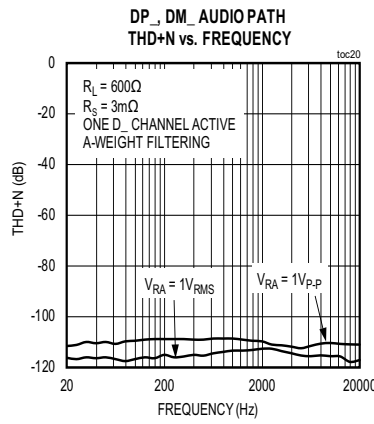
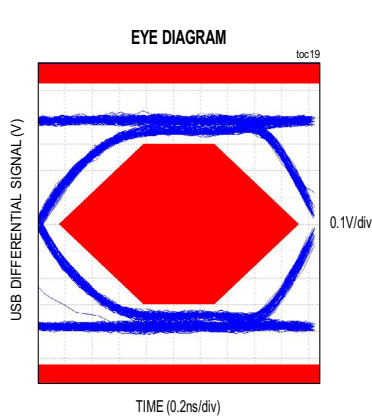

Typical Operating Characteristics (continued)

($V_{CC} = 3.7V$, $T_A = +25^\circ C$ unless otherwise noted.)

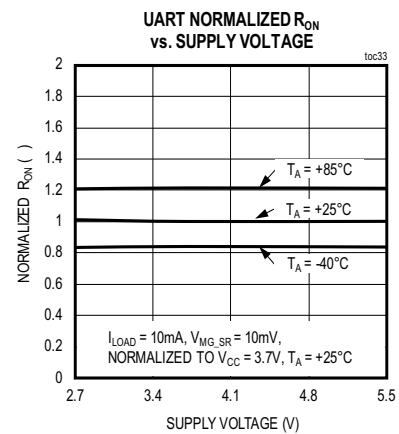
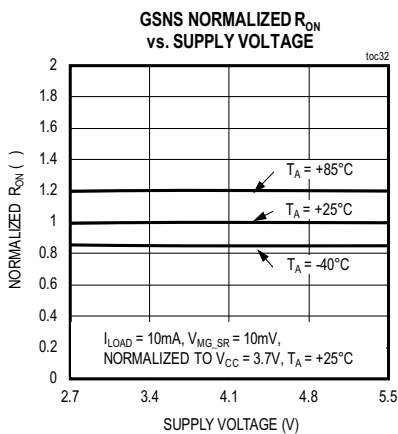
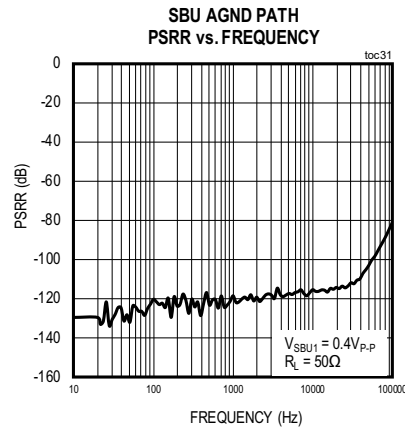
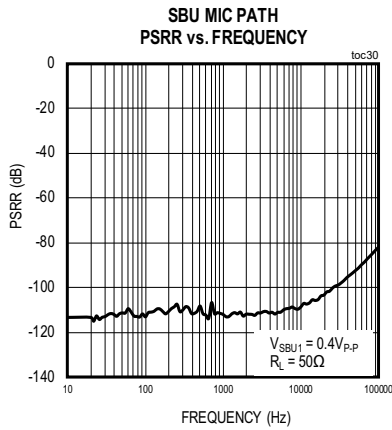
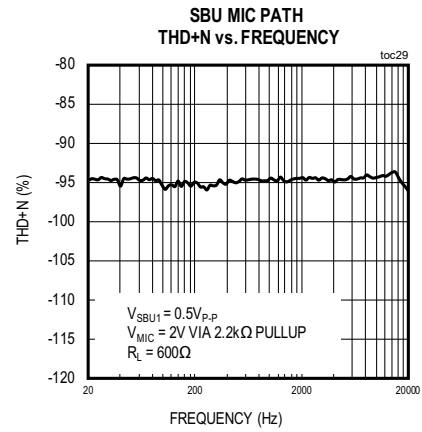
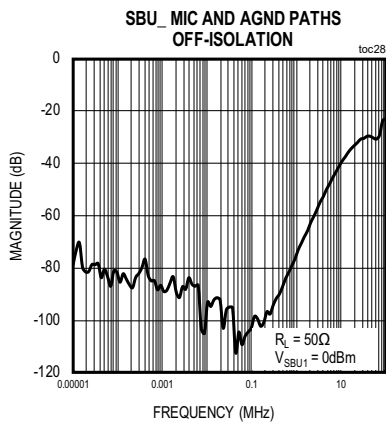

Typical Operating Characteristics (continued)

($V_{CC} = 3.7V$, $T_A = +25^\circ C$ unless otherwise noted.)

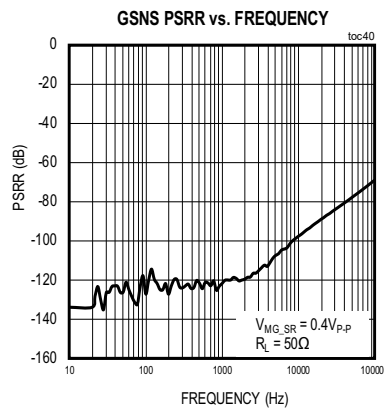
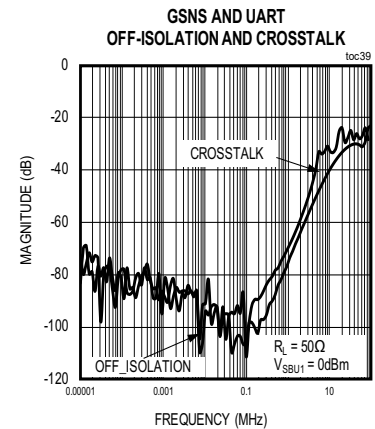
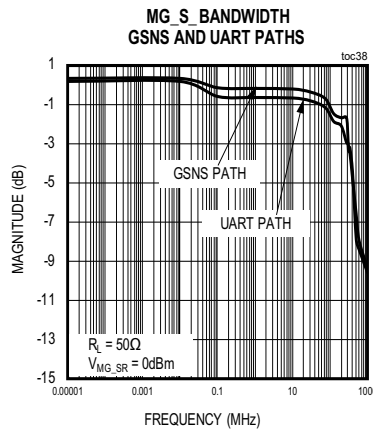
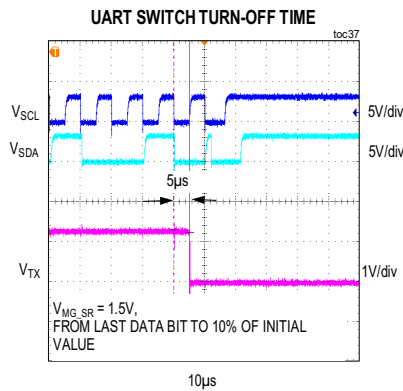
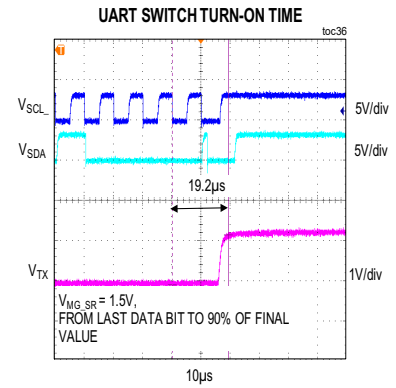
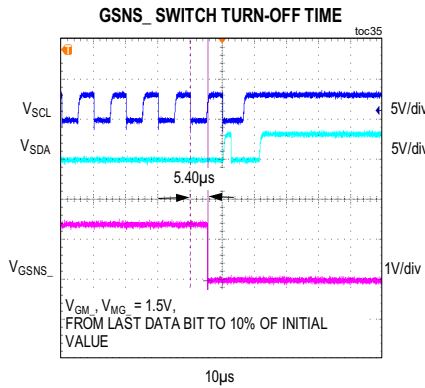
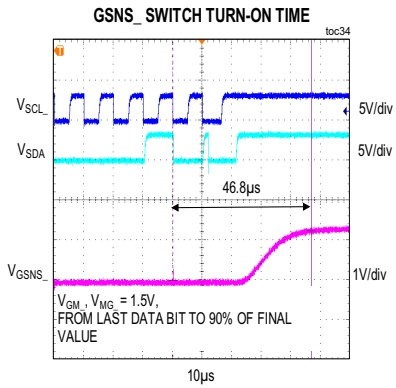

Bump Configurations

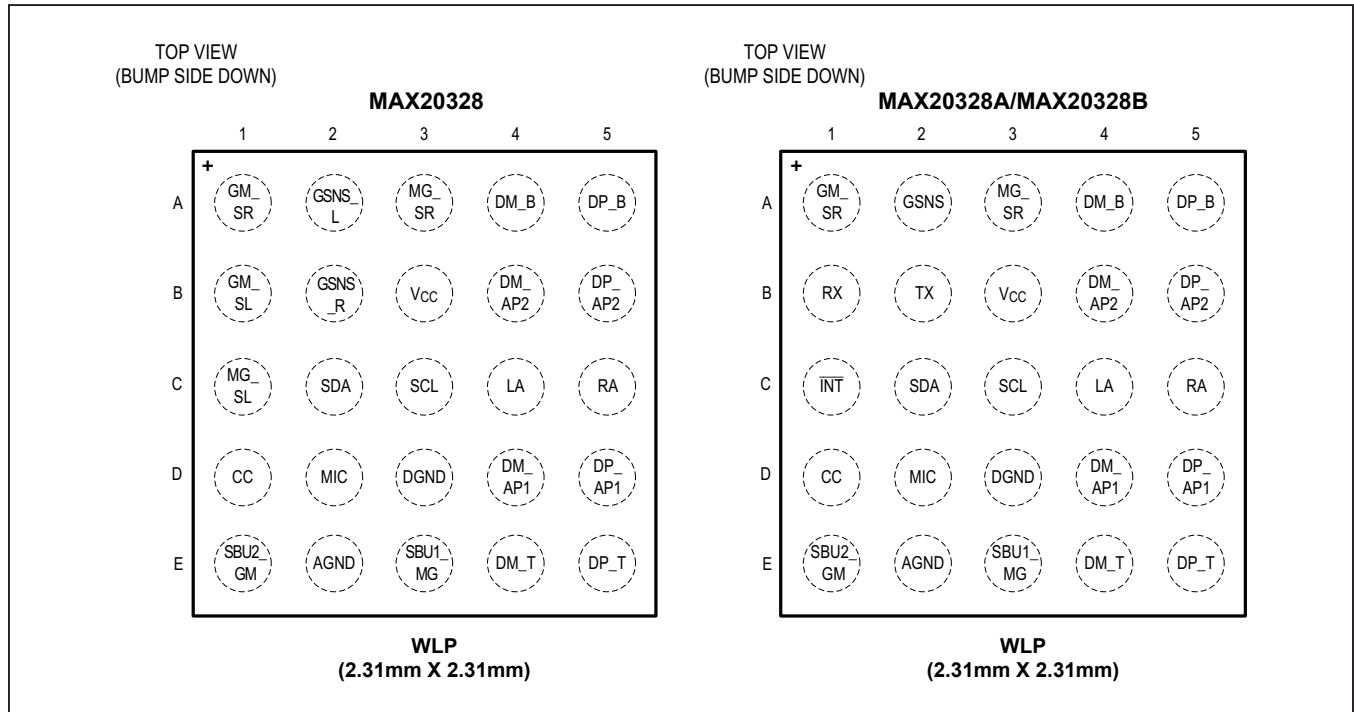

Bump Description

BUMP		NAME	FUNCTION
MAX20328	MAX20328A/ MAX20328B		
A1	A1	GM_SR	Analog Ground/MIC Sense Input for Right Audio Channel
A2	—	GSNS_L	Ground Sense Output for Left Audio Channel
—	A2	GSNS	Ground Sense Output
A3	A3	MG_SR	MIC/Analog Ground Sense Input for Right Audio Channel
A4	A4	DM_B	DM Bottom Side Data Line of the External USB Type-C Port
A5	A5	DP_B	DP Bottom Side Data Line of the External USB Type-C Port
B1	—	GM_SL	Analog Ground/MIC Sense Input for Left Audio Channel
—	B1	RX	UART RX Line
B2	—	GSNS_R	Ground Sense Output for Right Audio Channel
—	B2	TX	UART TX Line
B3	B3	Vcc	Power Supply. Bypass to ground with 1µF effective capacitance.
B4	B4	DM_AP2	DM Data Line to AP2
B5	B5	DP_AP2	DP Data Line to AP2

Bump Description (continued)

BUMP		NAME	FUNCTION
MAX20328	MAX20328A/ MAX20328B		
C1	—	MG_SL	MIC/Analog Ground Sense Input for Left Audio Channel
—	C1	$\overline{\text{INT}}$	Open Drain Output for Interrupt Signaling. Active low.
C2	C2	SDA	I ² C Data Line
C3	C3	SCL	I ² C Clock Line
C4	C4	LA	Left Audio Channel Output
C5	C5	RA	Right Audio Channel Output
D1	D1	CC	CC Line from the External USB Type-C Port
D2	D2	MIC	MIC Output
D3	D3	DGND	Digital Ground. Connect DGND and AGND together for correct operation.
D4	D4	DM_AP1	DM Data Line to AP1
D5	D5	DP_AP1	DP Data Line to AP1
E1	E1	SBU2_GM	Analog Ground/MIC, SBU2 Line
E2	E2	AGND	Analog Ground Substrate Connection. Connect DGND and AGND together for correct operation.
E3	E3	SBU1_MG	MIC/Analog Ground, SBU1 Line
E4	E4	DM_T	DM Top Side Data Line of the External USB Type-C Port
E5	E5	DP_T	DP Top Side Data Line of the External USB Type-C Port

Block Diagram

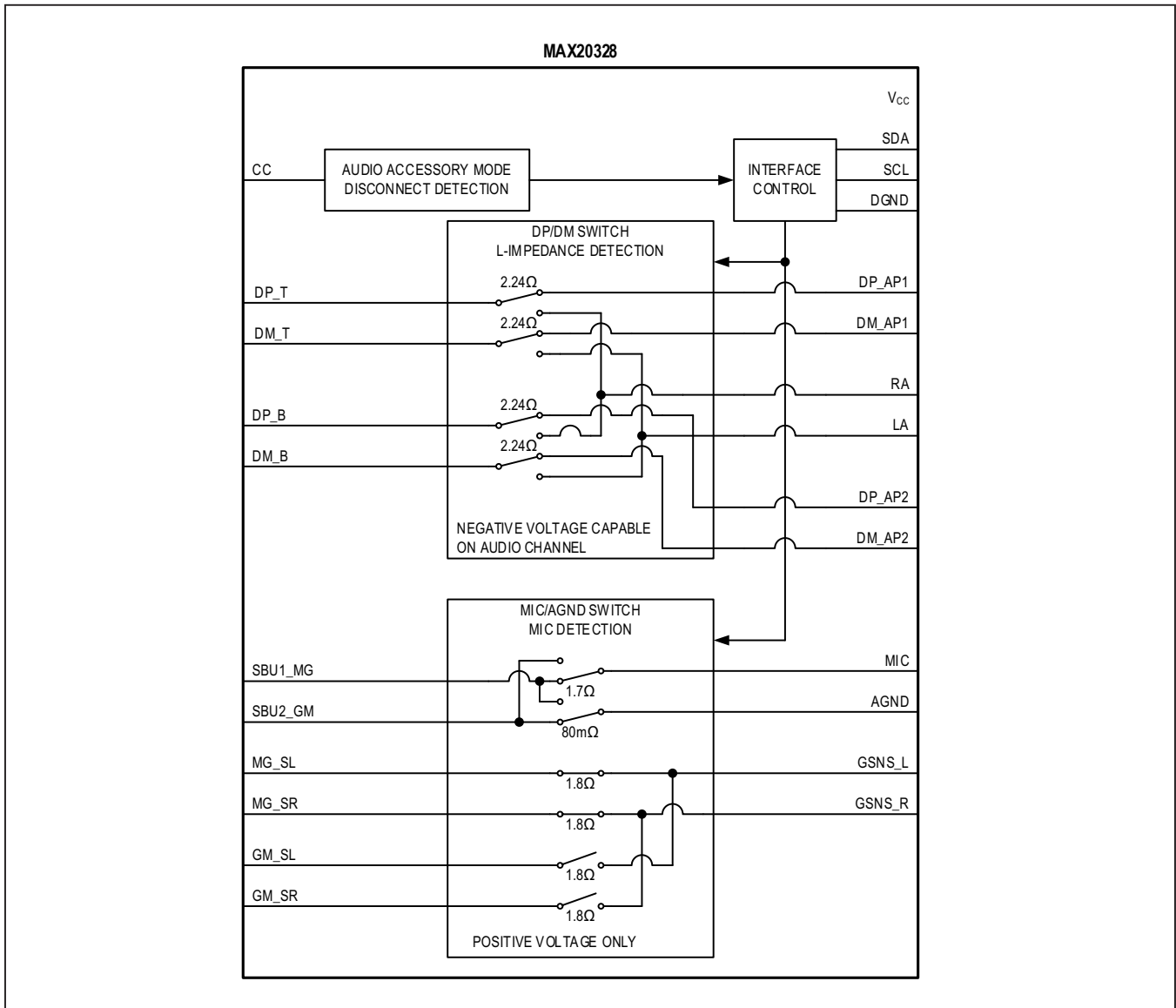

Block Diagram (continued)

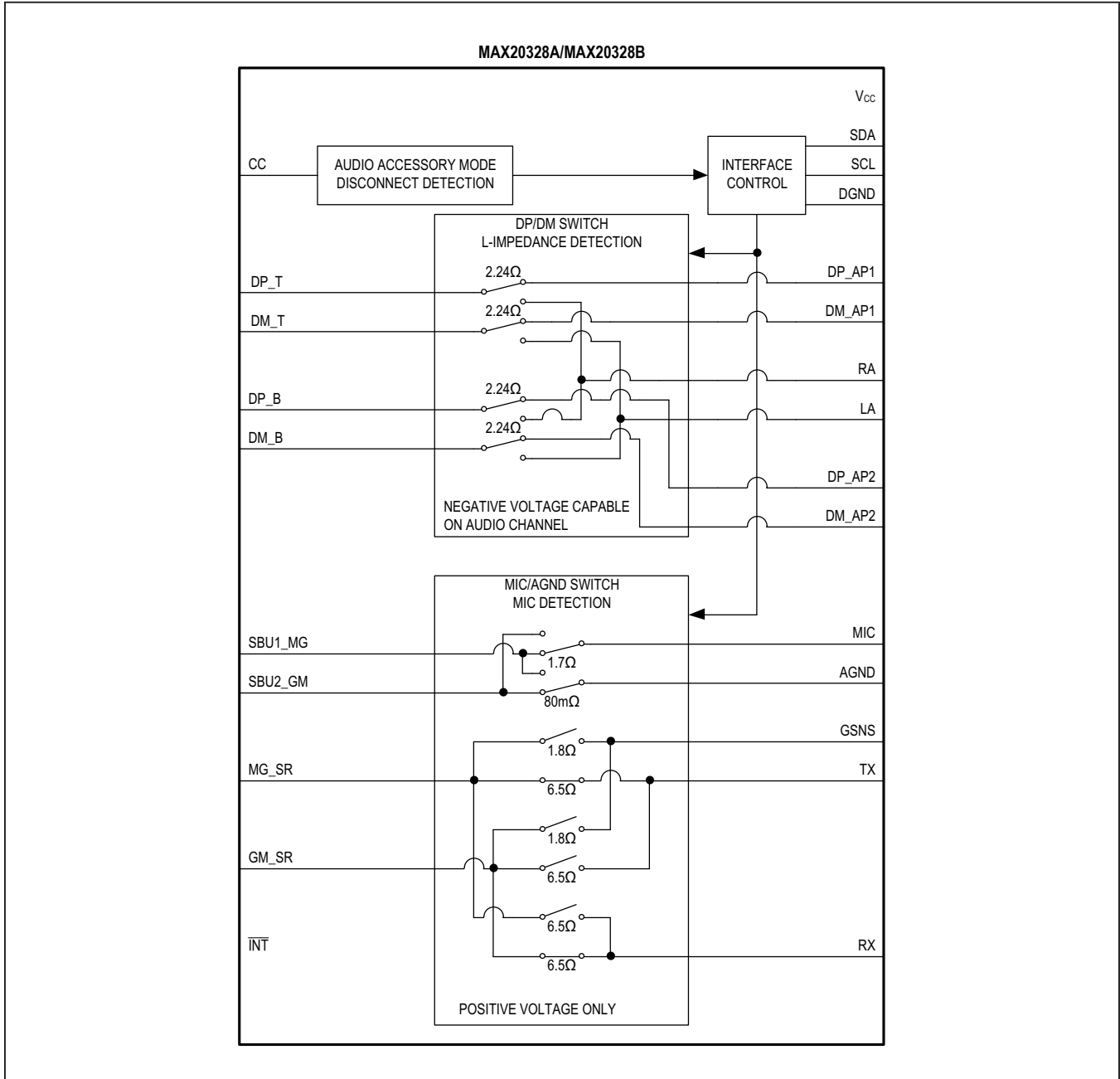

Detailed Description

The MAX20328/MAX20328A/MAX20328B are USB Type-C audio interface and protection ICs for use in portable devices. As USB power delivery makes a high-voltage charging solution readily available on Type-C connectors, the data and SBU lines are at risk of shorting to a high bus voltage, causing permanent damage to the portable device.

The MAX20328/MAX20328A/MAX20328B route incoming signals through the USB Type-C data path or audio path based on information received from a Type-C controller IC or the application processor (AP) controller.

The devices offer automatic microphone orientation and impedance detection for audio devices, pop-up noise suppression, and surge protection on pins connected directly to the USB Type-C port.

Operation

All switches are open until the MAX20328/MAX20328A/MAX20328B are enabled. To enable the devices, write the EN bit (0x06[4]) high. Once enabled, the switches default to the behaviors selected by the MODE[2:0] bits (0x06[2:0]) in automatic mode. See [Table 1](#) and [Table 2](#) for the switch configurations of each MODE[2:0] setting.

Table 1. MAX20328 Switch Configurations

MODE[2:0]	SWITCH CONNECTION									
	DP_T	DM_T	DP_B	DM_B	SBU1_MG	SBU2_GM	MG_SL	MG_SR	GM_SL	GM_SR
OFF [000]	OPEN	OPEN	OPEN	OPEN	OPEN	OPEN	OPEN	OPEN	OPEN	OPEN
ON A [001]	DP_AP1	DM_AP1	DP_AP2	DM_AP2	MIC	AGND	OPEN	OPEN	GSNS_L	GSNS_R
ON B [010]	DP_AP1	DM_AP1	DP_AP2	DM_AP2	AGND	MIC	GSNS_L	GSNS_R	OPEN	OPEN
Set by 0x0D and 0x0E [011]	—	—	—	—	—	—	—	—	—	—
UART [100]	DP_AP1	DM_AP1	DP_AP2	DM_AP2	OPEN	OPEN	OPEN	GSNS_R	GSNS_L	OPEN
USB [101]	DP_AP1	DM_AP1	DP_AP2	DM_AP2	OPEN	OPEN	OPEN	OPEN	OPEN	OPEN
Audio Accessory (Dual Ground Sense) [110]*	RA	LA	RA	LA	MIC *(1)	AGND *(1)	OPEN *(1)	OPEN *(1)	GSNS_L *(1)	GSNS_R *(1)
					AGND *(2)	MIC *(2)	GSNS_L *(2)	GSNS_R *(2)	OPEN *(2)	OPEN *(2)
Audio Accessory (Single Ground Sense) [111]*	RA	LA	RA	LA	MIC *(1)	AGND *(1)	OPEN *(1)	OPEN *(1)	GSNS_L *(1)	OPEN *(1)
					AGND *(2)	MIC *(2)	GSNS_L *(2)	OPEN *(2)	OPEN *(2)	OPEN *(2)

* Controlled by the state machine. Refer to the state diagram of [Figure 1](#).

*(1) When MG_CHK_DIS = 1 OR ADC_CTL ≠ 11, configuration valid when CC_POS = 0

*(2) When MG_CHK_DIS = 1 OR ADC_CTL ≠ 11, configuration valid when CC_POS = 1

Table 2. MAX20328A/MAX20328B Switch Configurations

MODE[2:0]	SWITCH CONNECTION									
	DP_T	DM_T	DP_B	DM_B	SBU1_MG	SBU2_GM	MG_SL	MG_SR	GM_SL	GM_SR
OFF [000]	OPEN	OPEN	OPEN	OPEN	OPEN	OPEN	—	OPEN	—	OPEN
ON A [001]	DP_AP1	DM_AP1	OPEN	OPEN	MIC	AGND	—	TX	—	RX
Default Mode [010/011]	—	—	—	—	—	—	—	—	—	—
UART [100]	DP_AP1	DM_AP1	OPEN	OPEN	OPEN	OPEN	—	TX*(1)	—	RX*(1)
								RX*(2)		TX*(2)
USB [101]	OPEN	OPEN	DP_AP2	DM_AP2	OPEN	OPEN	—	TX*(1)	—	RX*(1)
								RX*(2)		TX*(2)
Audio Accessory (Single ground sense) SBU1_MG = MIC SBU1_MG = AGND [110/111]*	RA	LA	RA	LA	MIC*(3)	AGND*(3)	—	OPEN*(3)	—	GSNS*(3)
					AGND*(4)	MIC*(4)		GSNS*(4)		OPEN*(4)

* Controlled by the state machine. Refer to the state diagram of [Figure 1](#).

*(1) CC_POS = 0

*(2) CC_POS = 1

*(3) When MG_CHK_DIS = 1 OR ADC_CTL ≠ 11, configuration valid when CC_POS = 0

*(4) When MG_CHK_DIS = 1 OR ADC_CTL ≠ 11, configuration valid when CC_POS = 1

Enable

The MAX20328/MAX20328A/MAX20328B are enabled by default (EN = 1). To disable a device, write EN = 0 (0x06[4] = 0). In the disable state, all switches are open and the devices enter a low-current mode to minimize the

supply current. When a device is disabled, the ADC_VAL register (0x01) and bits 0x02[7:6] and 0x02[3:0] are reset to 0. These bits provide information regarding the audio accessory impedance and microphone orientation. When EN is set to 1, the device runs through the state machine diagrammed in [Figure 1](#).

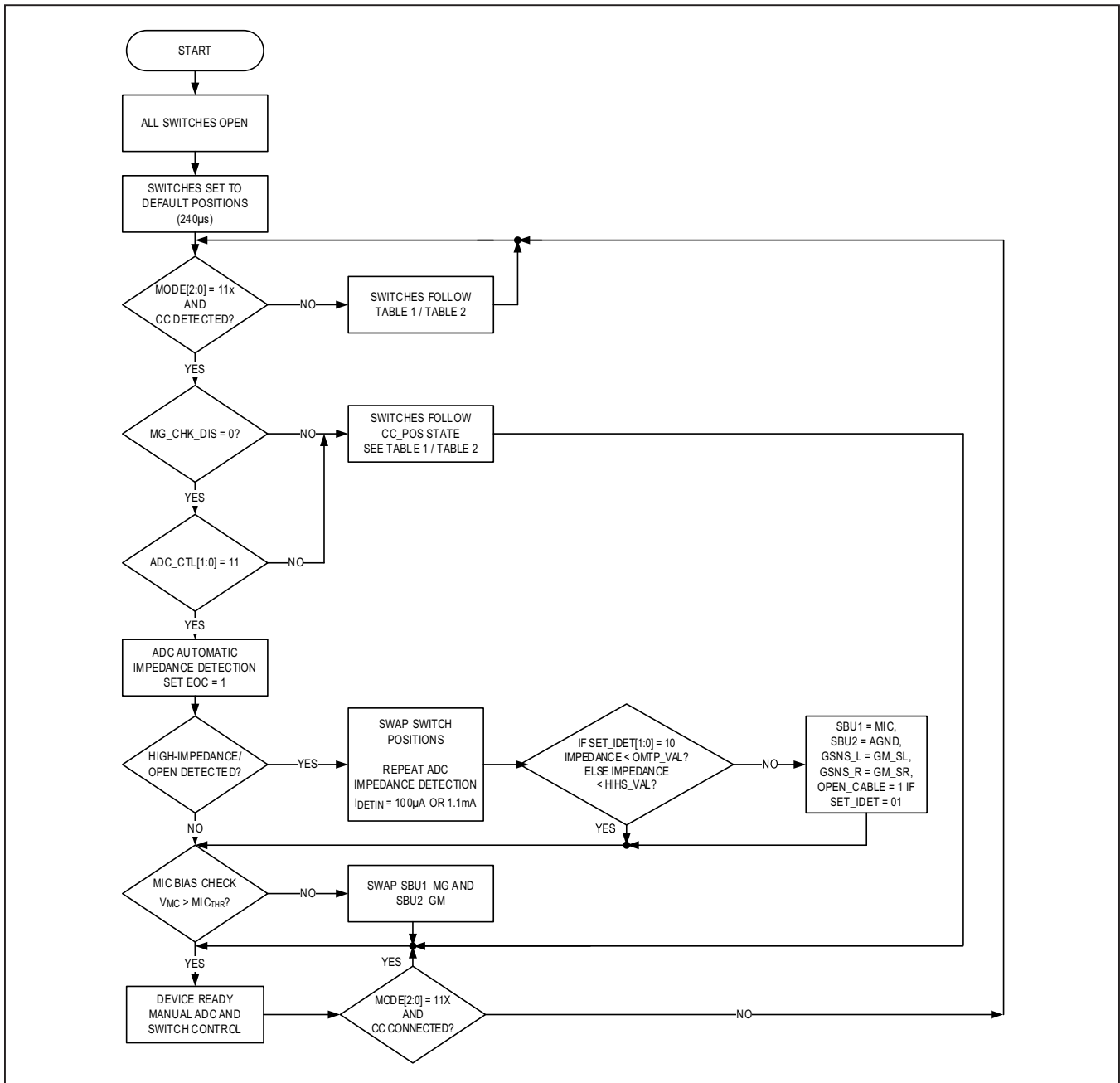

Figure 1. Startup State Machine (FSM)

Pop-Up Noise Suppression

If a 3.5mm jack is removed from a USB Type-C audio adapter when the adapter is connected to a portable device, pop-up noise may be heard due to the MIC line bias. When the CC pin goes high to signal an audio accessory removal, the MIC/AGND and AGND/MIC switches disconnect from the MIC bias and discharge to ground within 50µs.

Impedance Detection

The MAX20328/MAX20328A/MAX20328B can perform an impedance detection to measure the impedance of a connected audio accessory or detect an open cable. This function uses a precision, 8-bit ADC to measure the voltage dropped across the left audio channel while the IDET current source is active. An impedance measurement triggers automatically when EN is set to 1 if ADC_CTL[1:0] = 11 and follows the state machine in [Figure 1](#). Changing MODE[2:0] to 1xx while the device is enabled also trig-

gers an automatic measurement. If ADC_CTL[1:0] = 01 or 10, impedance measurements are manually triggered by writing FORCE_ADC_START high.

When OPEN_DETECT = 1 (0x09[5]), the impedance detection starts with IDET = 100µA. Otherwise, the 1.1mA and 5.5mA current sources are used for low impedance detection. [Figure 2](#) details the impedance detection process.

Current Sources

Three current source values are available for impedance detection. For high impedance audio accessories and open cable detection, a 100µA source is used. When the accessory impedance is low, i.e. ADC_VAL < HIHS_VAL after EOC goes high, IDET switches to 1.1mA. For very low impedance accessories, the 1.1mA source increases to 5.5mA. The value of the current source used in the latest impedance measurement is available in SET_IDET[1:0] (0x09[3:2]).

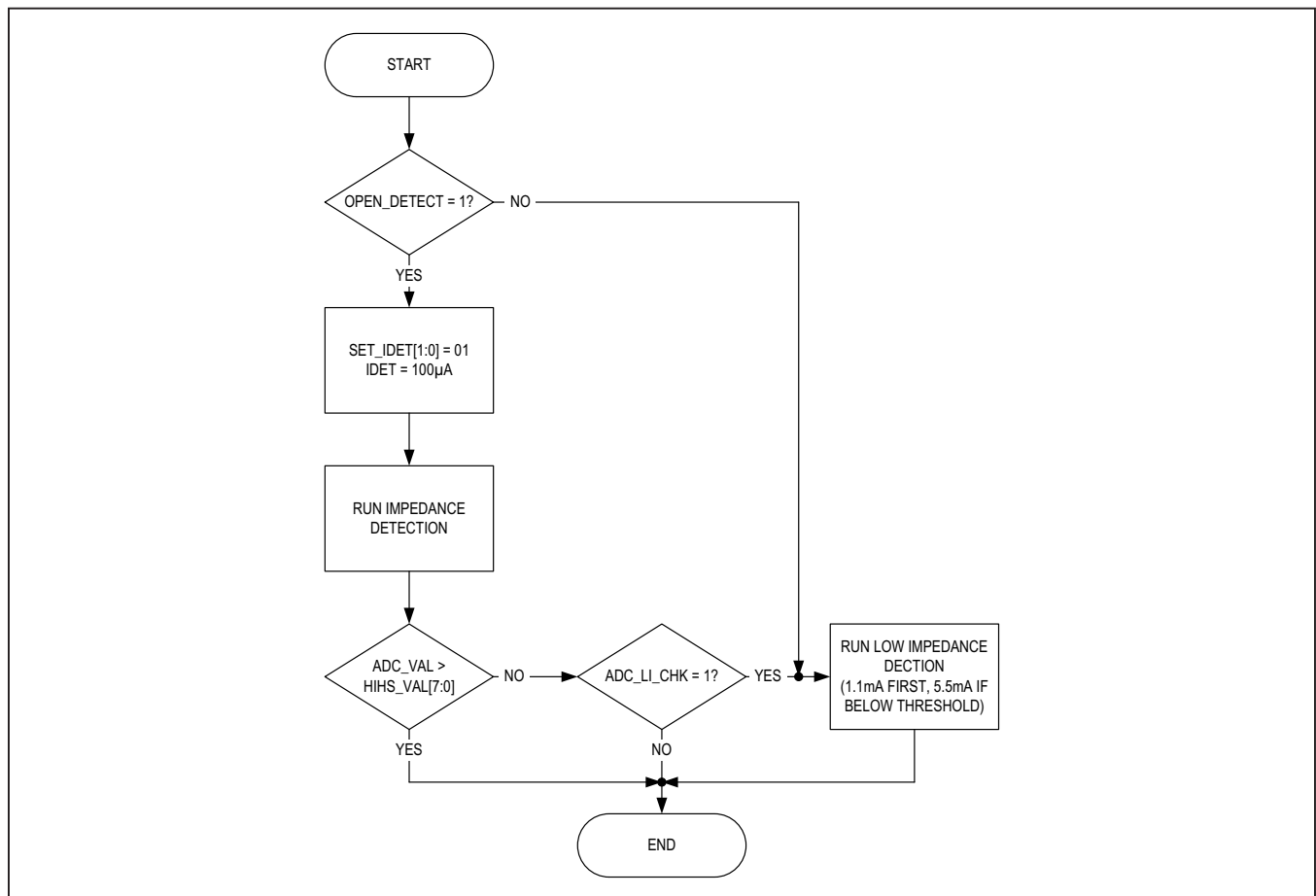

Figure 2. Impedance Detection Process

ADC Result

When the EOC bit goes high, the ADC result is available in ADC_VAL (register 0x01). The following conversion extracts the channel impedance from ADC_VAL and SET_IDET[1:0]

$$R = (\text{ADC_VAL}[7:0] \times 4.746\text{mV}) / \text{SET_IDET}[1:0]$$

To account for potential offsets in the ADC and current source values, [Table 3](#) provides the minimum and maximum values the ADC may provide for common headset impedance values.

Open Cable Check

The MAX20328/MAX20328A/MAX20328B can perform an open cable check during the impedance measurement. If the 100µA current source detects a high impedance where ADC_VAL > HIHS_VAL, the OPEN_CABLE bit (0x02[3]) goes high to signal the open cable.

MIC/GND Detection

Because a USB Type-C audio accessory can be inserted in two orientations, it is necessary to identify the MIC and GND lines. After an impedance detection, the state machine determines if the MIC/AGND switches are in the correct orientations. If ADC_VAL is greater than the thresholds set in OMTP_VAL or HIHS_VAL, the switch positions are swapped and the impedance measurement is repeated.

In cases where the 3.5mm to USB Type-C adapter has a non-standard internal connection of one SBU to ground, there is the potential risk for the MIC line to be shorted to ground. To prevent this situation, the MAX20328/MAX20328A/MAX20328B can check for the presence of a bias on the MIC line at the end of an automatic impedance detection. When MIC_CHK_DIS = 0 (0x07[1]), the devices check for a bias greater than MIC_THR on the MIC line. If no bias is detected, the states of the MIC/AGND switches are swapped immediately after the DEVICE_READY bit goes high. To prevent the bias check from incorrectly reassigning the switches, a bias voltage must be applied to MIC before running an impedance detection.

I²C Interface

The MAX20328/MAX20328A/MAX20328B use the two-wire I2C interface to communicate with a host application processor. The configuration settings and status information provided through this interface are detailed in the register descriptions ([Tables 5–19](#)). Both devices use the seven-bit slave address 0b0010101 (0x2A for writes, 0x2B for reads).

Applications Information

Applying Signals to an Open Switch

Due to the structure of the DP_/DM_ inputs, the switches will not close when a large, high frequency signal is applied to the open terminal. To ensure the desired path closes properly, avoid applying fast signals >1V to the DP_/DM_ pins before closing the switch.

Table 3. ADC to Impedance Range Conversion Guide

ACCESSORY IMPEDANCE (Ω)	RESISTOR RANGE (Ω)		ADC CODE (HEX)		SET_IDET[1:0]	
	Min	Max	Low	High	Low	High
16	0	22.4	00	1A	1	1
32	25.0	40.6	1D	2F	1	1
64	44.9	87.2	34	65	1	1
150	94.9	189.8	16	2C	1	0
300	211.4	431.5	31	64	1	0
600	474.6	957.8	6E	DE	1	0
2000	1,001.4	12,150	15	FF	0	x

I²C Serial Interface

The I²C serial interface is used to configure the device. [Figure 3](#) shows the I²C timing diagram.

Serial Addressing

When in I²C mode, the devices operate as slave devices that send and receive data through an I²C-compatible 2-wire interface. The interface uses a serial data line (SDA) and a serial-clock line (SCL) to achieve bidirectional communication between master(s) and slave(s). A master (typically a microcontroller) initiates all data transfers to and from the MAX20328/MAX20328A/MAX20328B and generates the SCL clock that synchronizes the data transfer. The SDA line operates as both an input and an open drain output. A pullup resistor is required on SDA. The SCL line operates only as an input. A pullup resistor is required on SCL if there are multiple masters on

the 2-wire interface, or if the master in a single-master system has an open drain SCL output. Each transmission consists of a START condition sent by a master, followed by the MAX20328/MAX20328A/MAX20328B 7-bit slave address plus R/W bit, a register address byte, one or more data bytes, and finally a STOP condition.

Start and Stop Conditions

Both SCL and SDA remain high when the interface is not busy. A master signals the beginning of a transmission with a START (S) condition by transitioning SDA from high to low while SCL is high ([Figure 4](#)). When the master has finished communicating with the slave, it issues a STOP (P) condition by transitioning SDA from low to high while SCL is high. The bus is then free for another transmission.

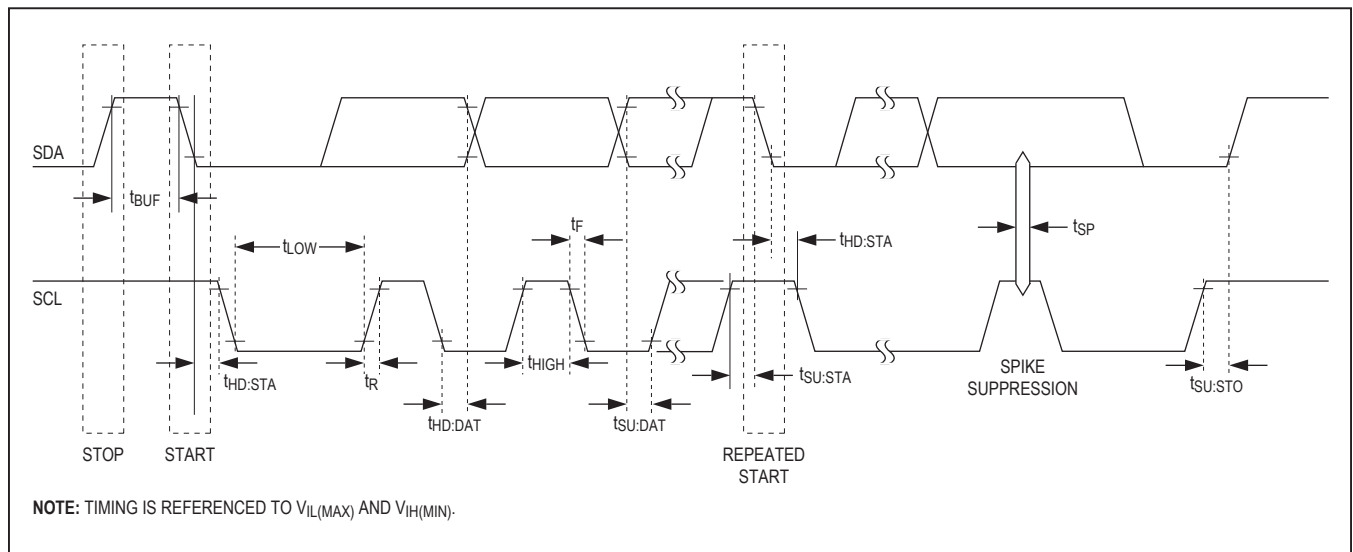

Figure 3. I²C Timing Diagram.

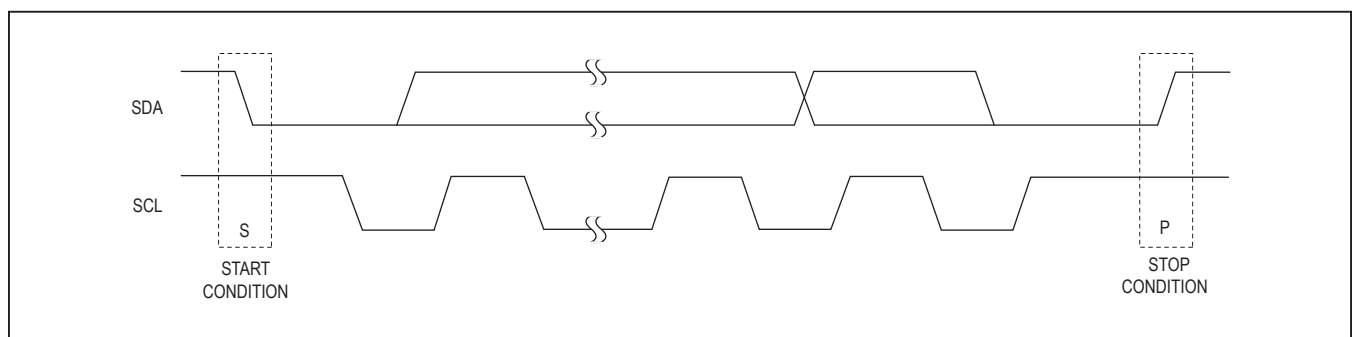

Figure 4. Start and Stop Conditions

Bit Transfer

One data bit is transferred during each clock pulse (Figure 5). The data on SDA must remain stable while SCL is high.

Acknowledge

The acknowledge bit is a clocked 9th bit (Figure 6), which the recipient uses to handshake receipt of each byte of data. Thus, each byte transferred effectively requires 9 bits. The master generates the 9th clock pulse, and the recipient pulls down SDA during the acknowledge clock pulse. The SDA line is stable low during the high period of the clock pulse. When the master is transmitting to the devices, it generates the acknowledge bit because the device is the recipient. When the device is transmitting to the master, the master generates the acknowledge bit because the master is the recipient. If the device does not pull SDA low, a not acknowledge is indicated.

Slave Address

The devices have a 7-bit slave address. The bit following a 7-bit slave address is the R/W bit, which is low for a write command and high for a read command. The slave address for the device is 0b00101011 for read commands and 0b00101010 for write commands. This is summarized in Table 4.

Table 4. I²C Slave Addresses

ADDRESS FORMAT	VALUE	
	HEX	BINARY
7-BIT SLAVE ADDRESS	0x15	001 0101
WRITE ADDRESS	0x2A	0010 1010
READ ADDRESS	0x2B	0010 1011

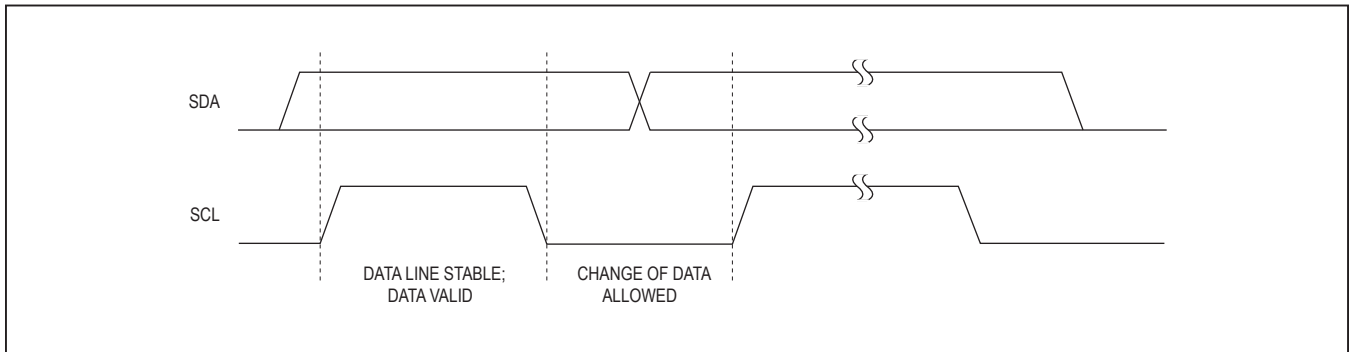

Figure 5. Bit Transfer

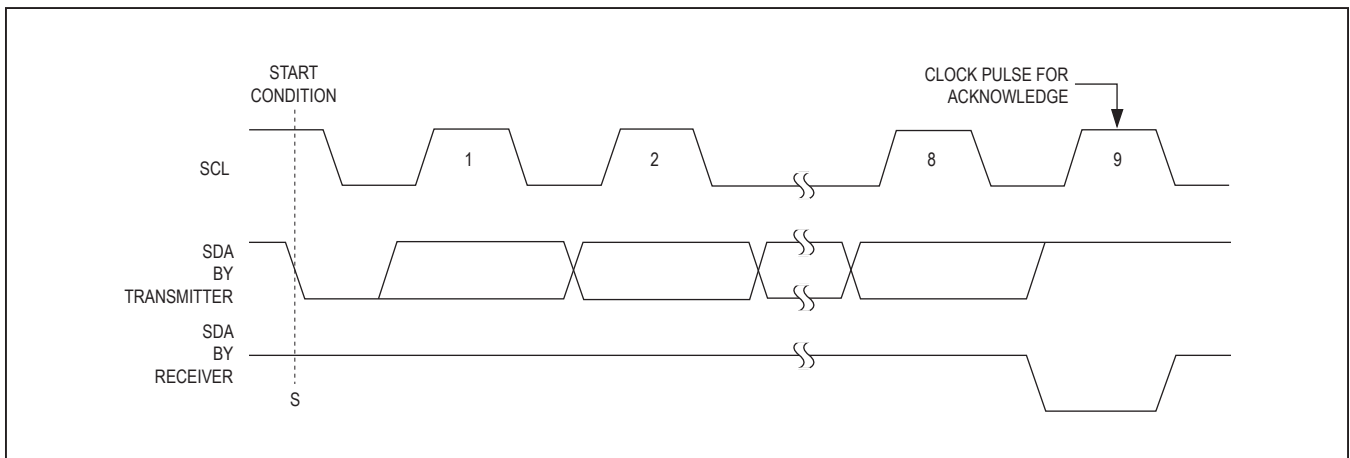

Figure 6. Acknowledge

Bus Reset

The MAX20328/MAX20328A/MAX20328B resets the bus with the I²C start condition for reads. When the R/W bit is set to 1, the MAX20328/MAX20328A/MAX20328B transmits data to the master, thus the master is reading from the device.

Format for Writing

A write to the devices comprises the transmission of the slave address with the R/W bit set to zero, followed by at least 1 byte of information. The first byte of information is the register address or command byte. The register address determines which register of the device is to be written by the next byte, if received. If a STOP (P) condition is detected after the register address is received, then the device takes no further action beyond storing the register address. Any bytes received after the register address are data bytes. The first data byte goes into the

register selected by the register address and subsequent data bytes go into subsequent registers (Figure 7). If multiple data bytes are transmitted before a STOP condition, these bytes are stored in subsequent registers because the register addresses auto-increments (Figure 8).

Format for Reading

The MAX20328/MAX20328A/MAX20328B is read using the internally stored register address as an address pointer, the same way the stored register address is used as an address pointer for a write. The pointer auto-increments after each data byte is read using the same rules as for a write. Thus, a read is initiated by first configuring the register address by performing a write (Figure 9). The master can now read consecutive bytes from the device, with the first data byte being read from the register addressed pointed by the previously written register address (Figure 10). Once the master sounds a NACK, the MAX20328/MAX20328A/MAX20328B stop sending valid data.

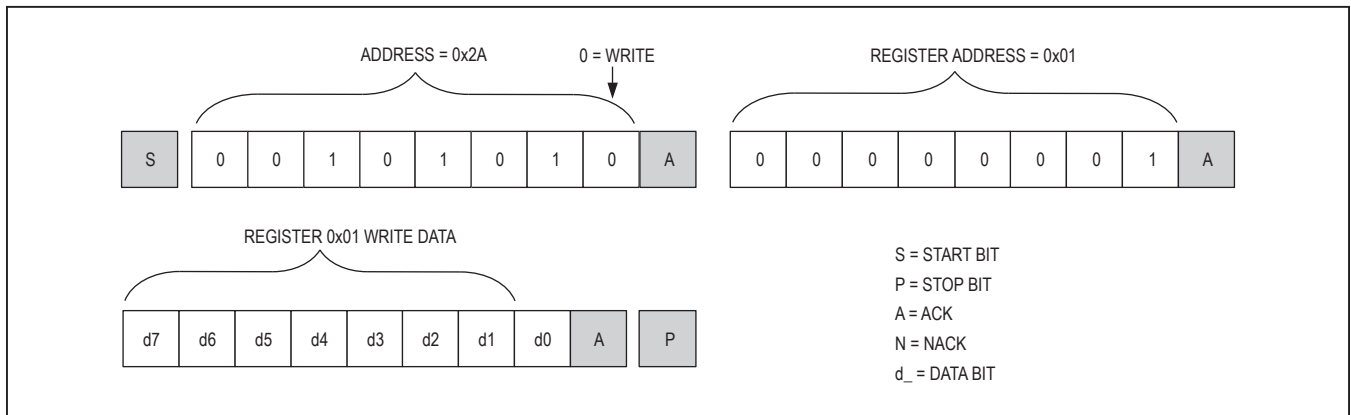

Figure 7. Format for I²C Write



Figure 8. Format for Writing to Multiple Registers

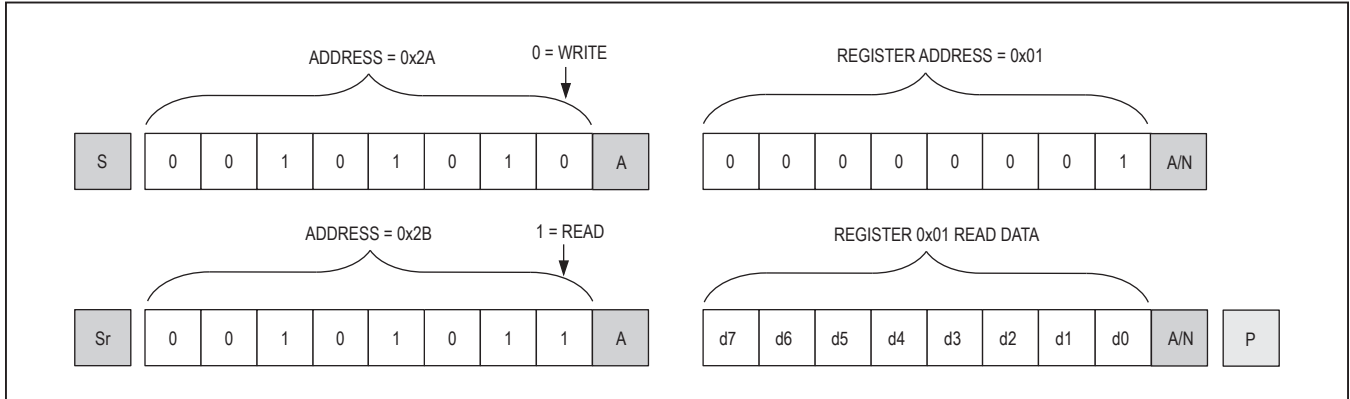

Figure 9. Format for Reads (Repeated Start)

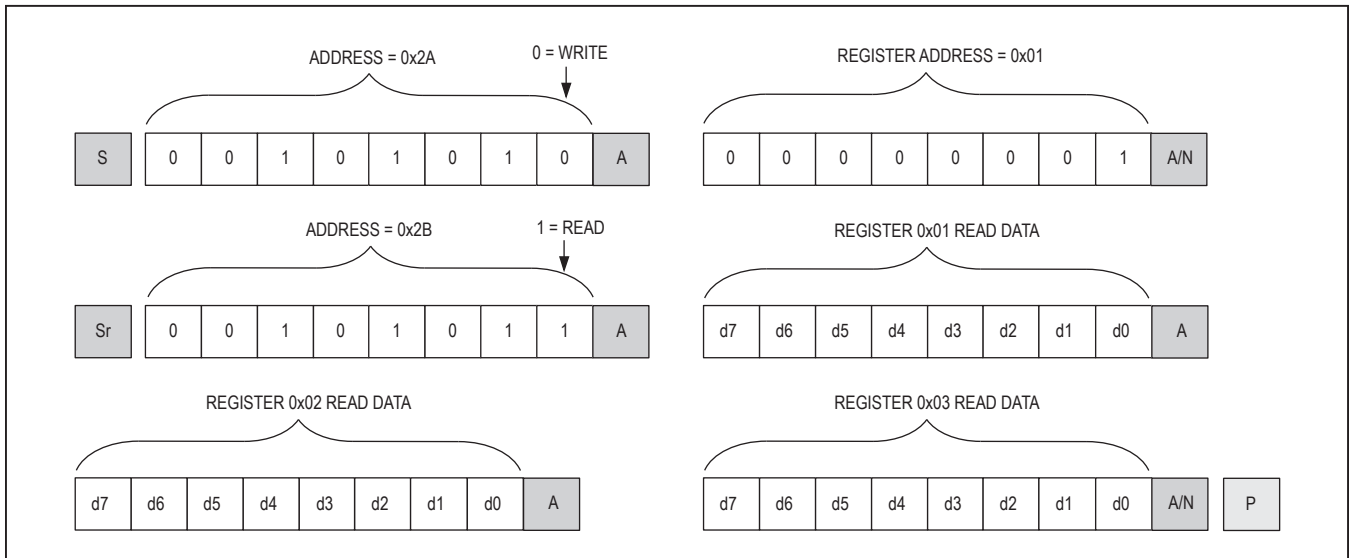

Figure 10. Format for Reading Multiple Registers

I2C Register Map

ADDRESS	NAME	R/W	B7	B6	B5	B4	B3	B2	B1	B0
0x00	DEVICE_ID	R	CHIP_ID[3:0]			CHIP_REV[3:0]				
0x01	ADC_VAL	R	ADC_VAL[7:0]							
0x02	STATUS1	R	IDET_LVL[1:0]	OVP_DPMT	OVP_SBU1	OPEN_CABLE	SBU_CFG	DEVICE_RDY	EOC	
0x03	STATUS2	R	THT_CMP	FUO	OVP_DPMB	OVP_SBU2	EOB	RFU[2:0]		
0x04	INTERRUPT	R/C	EOBi	DPMT_OVi	DPMB_OVi	SBU1_OVi	SBU2_OVi	OPEN_CABi	DEVICE_RDYi	EOCi
0x05	MASK	R/W	EOBm	DPMT_OVm	DPMB_OVm	SBU1_OVm	SBU2_OVm	OPEN_CABm	DEVICE_RDYm	EOCm
0x06	CONTROL1	R/W	CC_CLR	CC_DEB	CC_POS	EN	MANUAL_OVP_RESTORE	MODE[2:0]		
0x07	CONTROL2	R/W	MAN_DPMT	MAN_DPMB	MAN_SBU	MAN_MGS	MAN_TXRX	RFU	MIC_CHK_DIS	FORCE_TXRX
0x08	CONTROL3	R/W	FORCE_DPMT[1:0]	FORCE_DPMB[1:0]	FORCE_DPMB[1:0]	FORCE_SBU_MG[1:0]	FORCE_MGS[1:0]			
0x09	ADC_CONTROL1	R/W	IDET_FLAT	MG_CHK_DIS	OPEN_DET	ADC_LI_CHK	SET_IDET[1:0]	ADC_CTL[1:0]		
0x0A	ADC_CONTROL2	R/W	SET_OVTH[1:0]	SET_OVTH2[1:0]	SET_OVTH2[1:0]	ADC_AVG#[1:0]	OVP_LATCH_OFF			
0x0B	HIHS_VAL	R/W	HIHS_VAL[7:0]							
0x0C	OMTP_VAL	R/W	OMTP_VAL[7:0]							
0x0D	SW_DEFLT1	R/W	DFT_DPMT[1:0]	DFT_DPMB[1:0]	DFT_DPMB[1:0]	RFU	DFT_SBU_MG[2:0]			
0x0E	SW_DEFLT2	R/W	DFT_MG_SL	DFT_MG_SR	DFT_MG_SL	DFT_GM_SR	RFU[1:0]	DFT_TXRX[1:0]		

* Cells shaded in light gray denote bits that are cleared on a device reset.

Table 5. DEVICE_ID Register (0x00)

ADDRESS	0x00							
MODE	Read Only							
BIT	7	6	5	4	3	2	1	0
NAME	CHIP_ID[3:0]				CHIP_REV[3:0]			
RESET MAX20328	0	0	0	0	0	0	0	1
RESET MAX20328A/ MAX20328B	1	0	0	0	0	0	0	1
CHIP_ID[3:0]	Chip ID Shows information about the version of MAX20328/MAX20328A/MAX20328B							
CHIP_REV[3:0]	Chip Revision Shows information about the revision of MAX20328/MAX20328A/MAX20328B							

Table 6. ADC_VAL Register (0x01)

ADDRESS	0x01							
MODE	Read Only							
BIT	7	6	5	4	3	2	1	0
NAME	ADC_VAL[7:0]							
RESET MAX20328	0	0	0	0	0	0	0	0
RESET MAX20328A / MAX20328B	0	0	0	0	0	0	0	0
ADC_VAL[7:0]	ADC Value Read only register containing the latest ADC conversion. LSB = 4.71mV							

Table 7. STATUS1 Register (0x02)

ADDRESS	0x02							
MODE	Read Only							
BIT	7	6	5	4	3	2	1	0
NAME	IDET_LVL[1:0]		OVP_DPMT	OVP_SBU1	OPEN_CAB	SBU_CFG	DEVICE_RDY	EOC
RESET MAX20328	0	0	0	0	0	0	0	0
RESET MAX20328A/ MAX20328B	0	0	0	0	0	0	0	0
IDET_LVL[1:0]	Detection Current Level Contains the last IDET level used for ADC Impedance Detection 00 = No Jack Insertion Default 01 = 100µA 10 = 1.1mA 11 = 5.5mA							
OVP_DPMT	DP, DM Top Side Over Voltage Protection Status Reports the status of the OVP on DP_T/DM_T 0 = No Fault 1 = OVP Fault Detected							
OVP_SBU1	SBU1 Over Voltage Protection Status Reports the status of the OVP on SBU1_MG, MG_SR, MG_SL (MAX20328 only) 0 = No Fault 1 = OVP Fault Detected							
OPEN_CABLE	Open Cable Detected Indicates if a cable is an open connection 0 = Cable is not open 1 = High impedance is detected for both CTIA and OMTP configurations when SET_IDET[1:0] = 01.							
SBU_CFG	MIC/GND Switch Orientation The MIC/GND positions reported after a Jack Orientation detection. This bit remains low if MG_CHK_DIS (0x09[6]) = 1. 0 = SBU1 connected to MIC, SBU2 connected to AGND 1 = SBU1 connected to AGND, SBU2 connected to MIC							
DEVICE_RDY	Device Ready Jack Type detection is complete and the device is ready. This bit is set after the impedance detection if MG_CHK_DIS = 1. 0 = MIC/GND switch position is NOT finalized. 1 = MIC/GND switch position is set and device is ready.							
EOC	End of ADC Conversion Reports the status of the ADC. 0 = ADC conversion is not started or in progress. 1 = ADC conversion is complete. The result is available in ADC_VAL (register 0x01)							

Table 8. STATUS2 Register (0x03)

ADDRESS	0x03							
MODE	Read Only							
BIT	7	6	5	4	3	2	1	0
NAME	THT_ CMP	FUO	OVP_ DPMB	OVP_ SBU2	EOB	RFU[2:0]		
RESET MAX20328	0	0	0	0	0	0	0	0
RESET MAX20328A/ MAX20328B	0	0	0	0	0	0	0	0
THT_CMP	Output of the thermal comparator. 0 = No thermal error 1 = Thermal shutdown error							
FUO	Factory Use Only							
OVP_DPMB	DP, DM Bottom Side Over Voltage Protection Status Reports the status of the OVP on DP_B/DM_B 0 = No Fault 1 = OVP Fault Detected							
OVP_SBU2	SBU2 Over Voltage Protection Status Reports the status of the OVP on SBU2_GM, GM_SR, GM_SL (MAX20328 only) 0 = No Fault 1 = OVP Fault Detected							
EOB	End of Boot Process Signals the end of the boot process 0 = Boot in Progress. Do not attempt any I ² C transactions 1 = Boot Complete. Device operates normally after the POR of an ENABLE event (0x06[4] low to high transition).							
RFU[2:0]	Reserved for Future Use							

Table 9. INTERRUPT Register (0x04)

ADDRESS	0x04							
MODE	Read Only, Clear on Read							
BIT	7	6	5	4	3	2	1	0
NAME	EOBi	DPMT_OVi	DPMB_OVi	SBU1_OVi	SBU2_OVi	OPEN_CABLEi	DEVICE_RDYi	EOCi
RESET MAX20328	0	0	0	0	0	0	0	0
RESET MAX20328A/ MAX20328B	0	0	0	0	0	0	0	0
EOBi	End of Boot Interrupt 0 = No Interrupt 1 = Interrupt Occurred							
DPMT_OVi	Top Side Data Line OVP Fault Interrupt This interrupt is not cleared after reading if the OVP condition is still present while reading. 0 = No Interrupt 1 = Interrupt Occurred							
DPMB_OVi	Bottom Side Data Line OVP Fault Interrupt This interrupt is not cleared after reading if the OVP condition is still present while reading. 0 = No Interrupt 1 = Interrupt Occurred							
SBU1_OVi	SBU1 Line OVP Fault Interrupt This interrupt is not cleared after reading if the OVP condition is still present while reading. 0 = No Interrupt 1 = Interrupt Occurred							
SBU2_OVi	SBU2 Line OVP Fault Interrupt This interrupt is not cleared after reading if the OVP condition is still present while reading. 0 = No Interrupt 1 = Interrupt Occurred							
OPEN_CABLEi	Open Cable Detect Interrupt 0 = No Interrupt 1 = Interrupt Occurred							
DEVICE_RDYi	Device Ready Interrupt 0 = No Interrupt 1 = Interrupt Occurred							
EOCi	End of Conversion Interrupt 0 = No Interrupt 1 = Interrupt Occurred							

Table 10. MASK Register (0x05)

ADDRESS	0x05							
MODE	Read/Write							
BIT	7	6	5	4	3	2	1	0
NAME	EOBm	DPMT_ OVm	DPMB_ OVm	SBU1_ OVm	SBU2_ OVm	OPEN_ CABLEm	DEVICE_ RDYm	EOCm
RESET MAX20328	0	0	0	0	0	0	0	0
RESET MAX20328A/ MAX20328B	0	0	0	0	0	0	0	0
EOBm	End of Boot Interrupt Mask 0 = Interrupt Masked 1 = Interrupt not Masked							
DPMT_OVm	Top Side Data Line OVP Fault Interrupt Mask 0 = Interrupt Masked 1 = Interrupt not Masked							
DPMB_OVm	Bottom Side Data Line OVP Fault Interrupt Mask 0 = Interrupt Masked 1 = Interrupt not Masked							
SBU1_OVm	SBU1 Line OVP Fault Interrupt Mask 0 = Interrupt Masked 1 = Interrupt not Masked							
SBU2_OVm	SBU2 Line OVP Fault Interrupt Mask 0 = Interrupt Masked 1 = Interrupt not Masked							
OPEN_CABLEm	Open Cable Detect Interrupt Mask 0 = Interrupt Masked 1 = Interrupt not Masked							
DEVICE_RDYm	Device Ready Interrupt Mask 0 = Interrupt Masked 1 = Interrupt not Masked							
EOCm	End of Conversion Interrupt Mask 0 = Interrupt Masked 1 = Interrupt not Masked							

Table 11. CONTROL1 Register (0x06)

ADDRESS	0x06							
MODE	Read/Write							
BIT	7	6	5	4	3	2	1	0
NAME	CC_CLR	CC_DEB	CC_POS	EN	MANUAL_OVP_ RESTORE	MODE[2:0]		
RESET MAX20328	0	0	0	1	0	0	1	1
RESET MAX20328A/ MAX20328B	0	0	0	1	0	0	1	1
CC_CLR	<p>Clear on Accessory Removal When this bit is high, the bits listed below are cleared when EN = 0 or a positive edge is detected on CC (accessory removal). When CC_CLR is low, the listed bits are not cleared on an accessory removal. 0 = Retain 0x01[7:0] and 0x02[7:6], 0x02[3:0] when EN = 0 or CC transitions from 0 to 1. 1 = Clear 0x01[7:0] and 0x02[7:6], 0x02[3:0] when EN = 0 or CC transitions from 0 to 1.</p>							
CC_DEB	<p>CC Debounce Time Controls the debounce time for detecting a falling edge on CC in accessory mode. 0 = No Debounce. A digital delay of 120 - 240µs is present for both edges. 1 = 10ms Debounce on CC falling. A digital delay of 240 - 360µs is present for CC rising.</p>							
CC_POS	<p>CC Position Input Determines if the CC pin of the device connects to CC1 or CC2 of the connector. 0 = CC1 to CC1 (straight) 1 = CC1 to CC2 (swapped)</p>							
EN	<p>Switch Enable Enables the switches. 0 = Switches Disabled 1 = Switches Enabled</p>							
MANUAL_ OVP_ RESTORE	<p>Manual OVP Restore Controls when switches will return to their previous state after an OVP event. 0 = Switches return to their previous state 10ms after the OVP event. 1 = Switches return to their previous state when OVP_LATCH_OFF (0x0A[1]) = 1.</p>							
MODE[2:0]	<p>Switch Operational Mode Select Configures the switch connection mode. MAX20328: 000 = Default OFF 001 = Default ON, position A (see Table 1) 010 = Default ON, position B (see Table 1) 011 = Default programmable with registers 0x0D and 0x0E 100 = UART 101 = USB 110 = Audio Accessory (single) 111 = Audio Accessory (dual) MAX20328A/MAX20328B: 000 = Default OFF (see Table 2) 001 = Default ON (see Table 2) 010/011 = Default programmable with registers 0x0D and 0x0E 100 = UART mode. Top side USB switches connected. 101 = USB mode. Bottom side USB switches connected. 110/111 = Audio Accessory (single)</p>							

Table 12. CONTROL2 Register (0x07)

ADDRESS	0x07							
MODE	Read/Write							
BIT	7	6	5	4	3	2	1	0
NAME	MAN_DPMT	MAN_DPMB	MAN_SBU	MAN_MGS	MAN_TXRX	RFU	MIC_CHK_DIS	FORCE_TXRX
RESET MAX20328	0	0	0	RFU	0	0	0	RFU
RESET MAX20328A/ MAX20328B	0	0	0	0	0	0	0	0
MAN_DPMT	Manual DP/DM Top Side Switch Setting Enables manual control of the DP_T/DM_T switches 0 = DP_T/DM_T follow MODE[2:0] (0x06[2:0]) 1 = DP_T/DM_T follow FORCE_DPMT[1:0] (0x08[7:6])							
MAN_DPMB	Manual DP/DM Bottom Side Switch Setting Enables manual control of the DP_B/DM_B switches 0 = DP_B/DM_B follow MODE[2:0] (0x06[2:0]) 1 = DP_B/DM_B follow FORCE_DPMB[1:0] (0x08[5:4])							
MAN_SBU	Manual SBU_ to MIC/AGND Switch Setting 0 = MIC/AGND switches follow MODE[2:0] (0x06[2:0]) 1 = MIC/AGND switches follow FORCE_SBU_MG[1:0] (0x08[3:2])							
MAN_MGS	Manual MG/GM Sense Switch Setting (MAX20328A/MAX20328B Only) 0 = MG_SL/MG_SR follow MODE[2:0] (0x06[2:0]) 1 = MG_SL/MG_SR follow FORCE_MGS[1:0] (0x08[1:0])							
MAN_TXRX	Manual TX/RX Switch Setting 0 = TX/RX switches follow MODE[2:0] (0x06[2:0]) 1 = TX/RX switches follow FORCE_TXRX (0x07[0])							
RFU	Reserved for Future Use							
MIC_CHK_DIS	Microphone Bias Check Disable Disables the MIC line bias check performed after an impedance detection. 0 = Check for MIC bias 1 = Skip MIC bias check							
FORCE_TXRX	Force TX/RX Control (MAX20328A/MAX20328B Only) Effective only when MAN_TXRX = 1. 0 = TX/RX switches closed according to the value of CC_POS (GSNS switch opens automatically) 1 = TX/RX switches are disconnected from MG_SR/GM_SR (GSNS switch open)							

Table 13. CONTROL3 Register (0x08)

ADDRESS	0x08							
MODE	Read/Write							
BIT	7	6	5	4	3	2	1	0
NAME	FORCE_DPMT[1:0]		FORCE_DPMB[1:0]		FORCE_SBU_MG[1:0]		FORCE_MGS[1:0]	
RESET MAX20328	0	0	0	0	0	0	0	0
RESET MAX20328A/ MAX20328B	0	0	0	0	0	0	0	0
FORCE_DPMT [1:0]	Manual DP/DM Top Side Control Effective only when MAN_DPMT = 1. 00 = Switches open 01 = Switches closed in data connection 10 = Switches closed in audio connection 11 = Switches open							
FORCE_DPMB [1:0]	Manual DP/DM Bottom Side Control Effective only when MAN_DPMB = 1. 00 = Switches open 01 = Switches closed in data connection 10 = Switches closed in audio connection 11 = Switches open							
FORCE_ SBU_MG[1:0]	Manual MIC/AGND Control Effective only when MAN_SBU = 1. 00 = Switches open 01 = Switches closed as SBU1 to MIC and SBU2 to AGND 10 = Switches closed as SBU1 to AGND and SBU2 to MIC 11 = Switches open							
FORCE_MGS [1:0]	Manual MG/GM Control Effective only when MAN_MGS = 1. 00 = Switches open 01 = Switches closed as MG_S_ to GSNS_ 10 = Switches closed as GM_S_ to GSNS_ 11 = Switches open							

Table 14. ADC CONTROL1 Register (0x09)

ADDRESS	0x09							
MODE	Read/Write							
BIT	7	6	5	4	3	2	1	0
NAME	IDET_FLAT	MG_CHK_DIS	OPEN_DETECT	ADC_LI_CHK	SET_IDET[1:0]		ADC_CTL[1:0]	
RESET MAX20328	1	0	1	1	0	0	1	1
RESET MAX20328A/ MAX20328B	1	0	1	1	0	0	1	1
IDET_FLAT	IDET Flat Period Sets the length of time IDET remains flat. 0 = 25ms 1 = 100ms							
MG_CHK_DIS	MIC/GND Position Detection Disable Disables automatic MIC/GND orientation detection when an audio accessory is connected. 0 = Perform automatic MIC/GND position detection 1 = Disable automatic MIC/GND position detection							
OPEN_DETECT	Open Cable Detection Enable Enables the 100µA current source to detect a high impedance or open cable. 0 = Open cable check disabled 1 = Open cable check enabled							
ADC_LI_CHK	Low Impedance Detection Enable Enables the 1.1 and 5.5mA current sources for audio accessory low impedance detection. 0 = Low impedance detection disabled 1 = Low impedance detection enabled							
SET_IDET[1:0]	Manual IDET Setting Set the IDET level to be used in an impedance check triggered by FORCE_ADC_START (0x0A[0]). 00 = 100µA 01 = 100µA 10 = 1.1mA 11 = 5.5mA							
ADC_CTL[1:0]	ADC Conversion Control Configures when the ADC performs an impedance detection. 00 = ADC and impedance detection are always off 01 = Manual impedance detection performed with a single ADC measurement triggered by FORCE_ADC_START. 10 = Manual impedance detection performed with multiple averaged ADC measurements triggered by FORCE_ADC_START. Set the number of ADC samples to average with ADC_AVG#[1:0] (0x0A[3:2]). 11 = Impedance detection follows FSM. See Figure 1 .							

Table 15. ADC CONTROL2 Register (0x0A)

ADDRESS	0x0A							
MODE	Read/Write							
BIT	7	6	5	4	3	2	1	0
NAME	SET_OVTH1[1:0]		SET_OVTH2[1:0]		ADC_AVG#[1:0]		OVP_LATCH_OFF	FORCE_ADC_START
RESET MAX20328	0	1	0	1	0	0	0	0
RESET MAX20328A/ MAX20328B	1	1	1	1	0	0	0	0
SET_OVTH1 [1:0]	Data/Audio Switch Overvoltage Threshold Set the OVP threshold on the DM_ and DP_ switch paths. 00 = 3.37V 01 = 4.0V 10 = 4.7V 11 = 5.0V							
SET_OVTH2 [1:0]	SBU_/GSNS_ Switch Overvoltage Threshold Set the OVP threshold on the SBU_ and GSNS_ switch paths. 00 = 3.37V 01 = 4.0V 10 = 4.7V 11 = 5.0V							
ADC_AVG# [1:0]	ADC Number of Samples Sets the number of ADC samples to average. 00 = 2 samples 01 = 4 samples 10 = 8 samples 11 = 16 samples							
OVP_LATCH_OFF	OVP Latch Reset Restores the previous state of switches after an OVP event. Only active when MANUAL_OVP_RESTORE = 1 (0x06[3]). 0 = No effect 1 = Switches restored to previous state							
FORCE_ADC_START	Force ADC Conversion Manually trigger an ADC impedance measurement when ADC_CTL[1:0] = 01 or 10. 0 = ADC operates normally 1 = Begin ADC conversion. Sets EOC upon completion (0x02[0]).							

Table 16. HIHS_VAL Register (0x0B)

ADDRESS	0x0B							
MODE	Read/Write							
BIT	7	6	5	4	3	2	1	0
NAME	HIHS_VAL[7:0]							
RESET MAX20328	0	0	0	0	1	1	0	0
RESET MAX20328A/ MAX20328B	0	0	0	0	1	1	0	0
HIHS_VAL[7:0]	High Impedance Threshold Sets the high impedance threshold for detection an open cable.							

Table 17. OMTP_VAL Register (0x0C)

ADDRESS	0x0C							
MODE	Read/Write							
BIT	7	6	5	4	3	2	1	0
NAME	OMTP_VAL[7:0]							
RESET MAX20328	0	0	1	1	0	0	0	0
RESET MAX20328A/ MAX20328B	0	0	1	1	0	0	0	0
OMTP_VAL [7:0]	OMTP Headset Detection Threshold Sets the ADC threshold below which an OMTP headset is detected							

Table 18. DEFAULT1 Register (0x0D)

ADDRESS	0x0D							
MODE	Read/Write							
BIT	7	6	5	4	3	2	1	0
NAME	DFT_DPMT[1:0]		DFT_DPMB[1:0]		RFU	DFT_SBU_MG[2:0]		
RESET MAX20328	0	1	0	1	0	0	0	0
RESET MAX20328A	0	1	0	1	0	0	0	0
RESET MAX20328B	0	1	0	0	0	0	0	0
DFT_DPMT [1:0]	Default DP_T/DM_T Switch Setting 00 = Switches open 01 = Switches closed in data connection 10 = Switches closed in audio connection 11 = Switches open							
DFT_DPMB [1:0]	Default DP_B/DM_B Switch Setting 00 = Switches open 01 = Switches closed in data connection 10 = Switches closed in audio connection 11 = Switches open							
RFU	Reserved for Future Use							
DFT_SBU_MG [2:0]	Default SBU_ Switch Setting 000 = Switches open 001 = SBU1 connected to MIC; SBU2 open 010 = SBU1 open; SBU2 connected to AGND 011 = SBU1 connected to MIC; SBU2 connected to AGND 100 = Switches open 101 = SBU1 connected to AGND; SBU2 open 110 = SBU1 open; SBU2 connected to MIC 111 = SBU1 connected to AGND; SBU2 connected to MIC							

Table 19. DEFAULT2 Register (0x0E)

ADDRESS	0x0E							
MODE	Read/Write							
BIT	7	6	5	4	3	2	1	0
NAME	DFT_MG_SL	DFT_MG_SR	DFT_GM_SL	DFT_GM_SR	RFU[1:0]		DFT_TXRX[1:0]	
RESET MAX20328	0	0	0	0	0	0	RFU	
RESET MAX20328A/ MAX20328B	RFU	0	RFU	0	0	0	0	0
DFT_MG_SL	Default MG_SL Switch Setting (MAX20328 only) 0 = Switch open 1 = MG_SL connected to GSNS_L							
DFT_MG_SR	Default MG_SR Switch Setting (Note 9) 0 = Switch open 1 = MG_SR connected to GSNS_R/GSNS							
DFT_GM_SL	Default GM_SL Switch Setting (MAX20328 only) 0 = Switch open 1 = GM_SL connected to GSNS_L							
DFT_GM_SR	Default GM_SR Switch Setting (Note 9) 0 = Switch open 1 = GM_SR connected to GSNS_R/GSNS							
RFU[1:0]	Reserved for Future Use							
DFT_TXRX[1:0]	Default TX/RX Switch Setting (MAX20328A/MAX20328B only) 00/11 = TX and RX disconnected from GM_SR and MG_SR 01 = TX connected to GM_SR, RX connected to MG_SR 10 = TX connected to MG_SR, RX connected to GM_SR							

Note 9: GSNS has higher priority than DFT_TXRX[1:0]. MG_SR/GM_SR will connect to GSNS if DFT_MG_SR[1:0]/DFT_GM_SR[1:0] conflict with DFT_TXRX[1:0]

Typical Application Circuit

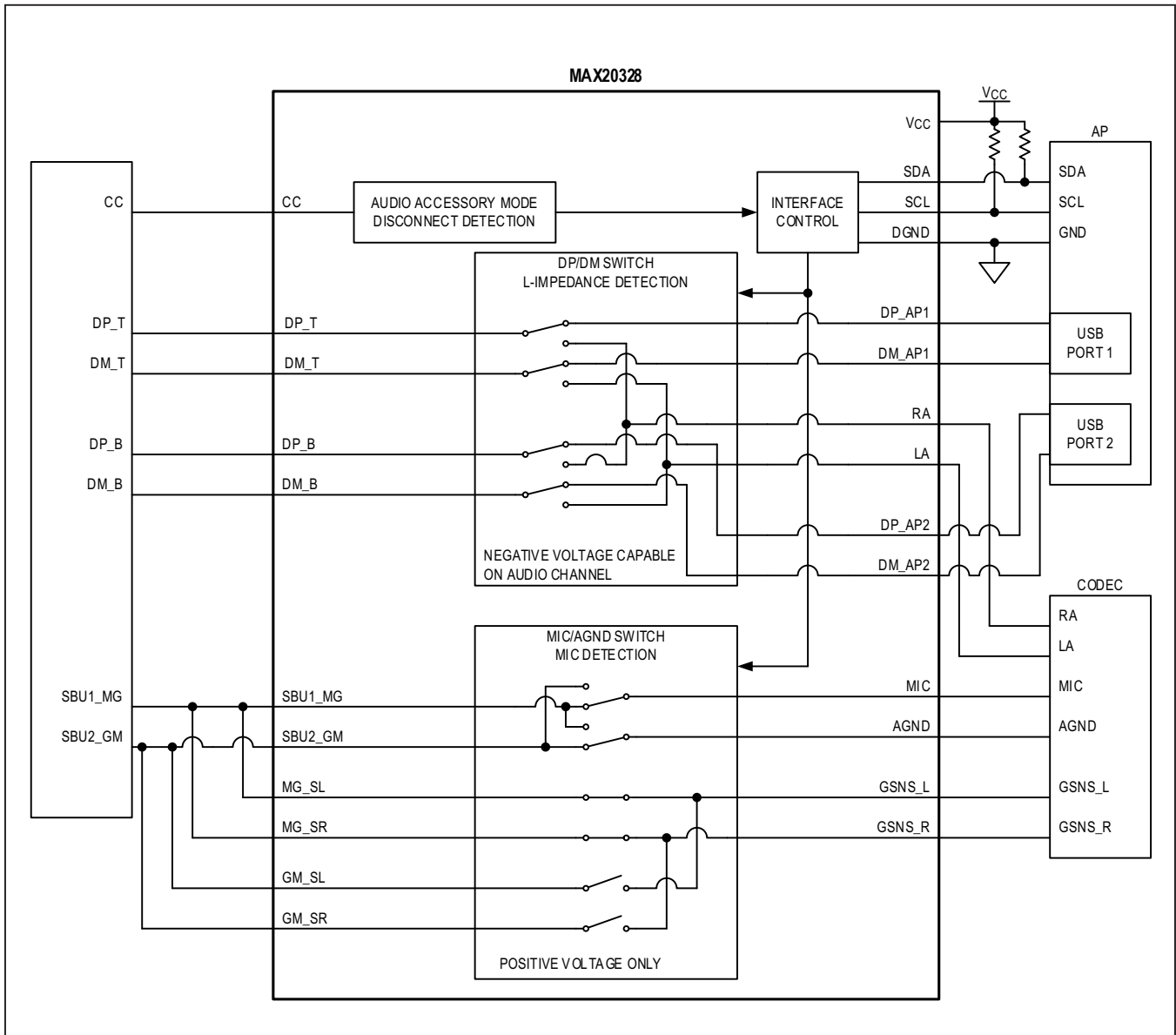

Typical Application Circuit (continued)

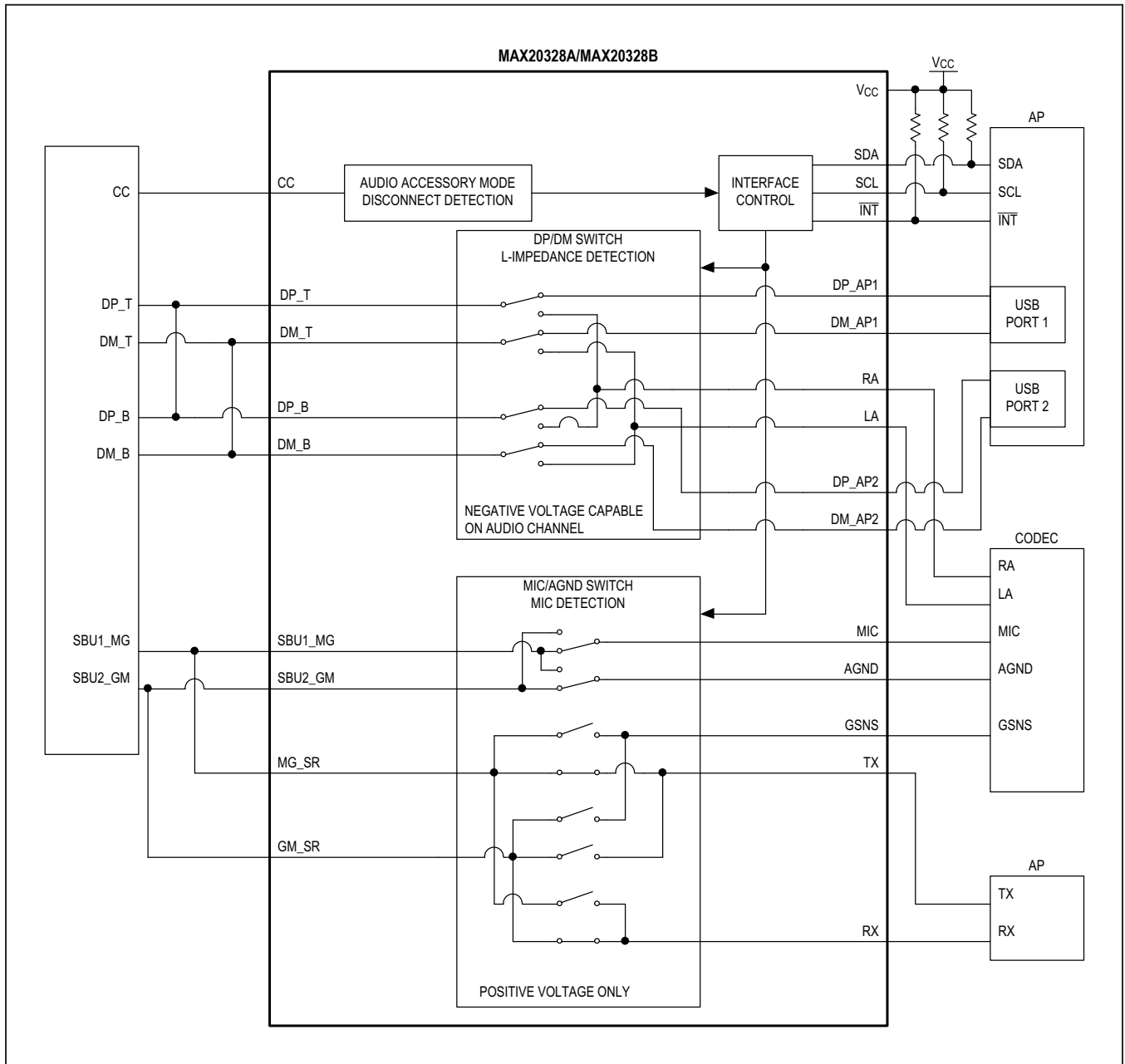

MAX20328/MAX20328A/
MAX20328B

MUX Switch for USB Type-C
Audio Adapter Accessories

Ordering Information

PART	TEMP RANGE	PIN-PACKAGE
MAX20328EWA+	-40°C to +85°C	25 WLP
MAX20328EWA+T	-40°C to +85°C	25 WLP
MAX20328AEWA+	-40°C to +85°C	25 WLP
MAX20328AEWA+T	-40°C to +85°C	25 WLP
MAX20328BEWA+	-40°C to +85°C	25 WLP
MAX20328BEWA+T	-40°C to +85°C	25 WLP

+Denotes a lead(Pb)-free/RoHS-compliant package.

T Denotes tape-and-reel

Chip Information

PROCESS: BiCMOS