

General Description

The MAX20330 evaluation kit (EV kit) is a fully assembled and tested circuit board that demonstrates the MAX20330 programmable OVLO with VBUS short detection device. The EV kit comes with the MAX20330EWA+ installed.

Features

- OVP or ID Detection
- Proven PCB Layout
- Fully Assembled and Tested

EV Kit Contents

- EV Kit Board Containing a MAX20330

Quick Start

Required Equipment

- MAX20330 EV kit
- Power supply
- Multimeter

Procedure

The EV kit is fully assembled and tested. Follow the steps below to verify board operation:

- 1) Connect a 3V power supply to VBUS TP1. Check the voltage on OUT. Verify OUT is also 3V.
- 2) Slowly increase VBUS voltage. Verify OUT voltage follows VBUS. When VBUS reaches ~6.8V, OUT voltage goes down.
- 3) Decrease VBUS voltage and OUT voltage comes back to be same as VBUS voltage.

[Ordering Information](#) appears at end of data sheet.

Detailed Description

The MAX20330 EV kit is a fully assembled and tested circuit board demonstrating the MAX20330 OVP/ID detector in an 8-bump wafer-level package (WLP).

VCC Power Supply

The V_{CC} can be connected from different power supply sources or externally supplied from TP7.

I²C Communication

Use JU2, JU3, JU4, JU5, and JU6 to have I²C pins pulled up to selected supply. User needs to provide I²C master to communicate with the device. The slave address is 0010 111.

Table 1. V_{CC} Jumper Setting

JUMPER	SHUNT POSITION	DESCRIPTION
JU1	1-2*	VCC is connected to VMC
	2-3	VCC is connected to 5VMC

*Default Position

Table 2. I²C Jumper Setting

JUMPER	SHUNT POSITION	DESCRIPTION
JU2	Installed	VIO is connected to VCC
	Not installed*	VIO is not connected to VCC
JU3	Installed	SCL is pulled up to VIO
	Not installed*	SCL is not pulled up to VIO
JU4	Installed	SDA is pulled up to VIO
	Not installed*	SDA is not pulled up to VIO
JU5	Installed	INTB is pulled up to VIO
	Not installed*	INTB is not pulled up to VIO
JU6	Installed	VIO is connected to VMC
	Not installed*	VIO is not connected to VMC

*Default Position

Ordering Information

PART	TYPE
MAX20330EVKIT#	EV Kit

#Denotes RoHS compliant.

MAX20330 EV Kit Bill of Materials

ITEM	REF_DES	DNI/DNP	QTY	MFG PART #	MANUFACTURER	VALUE	DESCRIPTION	COMMENTS
1	C1	-	1	C1210C105K5RAC	KEMET	1UF	CAPACITOR; SMT; 1210; CERAMIC; 1uF; 50V; 10%; X7R; -55degC to + 125degC;	
2	C2	-	1	C0603Y102K5RACAUTO	KEMET	1000PF	CAP; SMT (0603); 1000PF; 10%; 50V; X7R; CERAMIC CHIP	
3	C3	-	1	GCM188R71H104KA12; GCM188R71H104K; CGA3E2X7R1H104K080AA	MURATA;MURATA;TDK	0.1UF	CAPACITOR; SMT (0603); CERAMIC CHIP; 0.1UF; 50V; TOL=10%; TG=-55 DEGC TO +125 DEGC; TC=X7R; AUTO	
4	C4	-	1	C3216X7R1E475K160AC	TDK	4.7UF	CAPACITOR; SMT (1206); CERAMIC CHIP; 4.7UF; 25V; TOL=10%; MODEL=C SERIES; TG=-55 DEGC TO +125 DEGC; TC=X7R	
5	D1	-	1	PTVS20VS1UR	NEXPERIA	20V	DIODE; TVS; SMT (SOD-123W); VRM=20V; IPP=12.3A	
6	J1	-	1	ZX62-B-5PA(33)	HIROSE ELECTRIC CO LTD.	ZX62-B-5PA(33)	CONNECTOR; MALE; SMT; USB MICRO B-TYPE; BOTTOM MOUNT; RIGHT ANGLE; 5PINS; WITH OPTION TO CONNECT SHIELD PINS	
7	J2	-	1	SBH11-PBPC-D20-ST-BK	SULLINS ELECTRONICS CORP.	SBH11-PBPC-D20-ST-BK	CONNECTOR; MALE; THROUGH HOLE; HEADER CONNECTOR; STRAIGHT; 40PINS; EDGE FOOTPRINT	
8	JU1	-	1	PBC03SAAN	SULLINS	PBC03SAAN	CONNECTOR; MALE; THROUGH HOLE; BREAKAWAY; STRAIGHT; 3PINS; -65 DEGC TO +125 DEGC	
9	JU2-JU6	-	5	PBC02SAAN	SULLINS ELECTRONICS CORP.	PBC02SAAN	EVKIT PART-CONNECTOR; MALE; THROUGH HOLE; BREAKAWAY; STRAIGHT; 2PINS; -65 DEGC TO +125 DEGC;	
10	LED1, LED2	-	2	SML-LX1206GW-TR	LUMEX OPTOCOMPONENTS INC	SML-LX1206GW-TR	DIODE; LED; STANDARD; GREEN; SMT (1206); PIV=2.2V; IF=0.02A; -40 DEGC TO +85 DEGC	
11	Q1	-	1	SISA72DN-T1-GE3	VISHAY SILICONIX	SISA72DN-T1-GE3	TRAN; NCH; POWERPAK1212-8; PD-(3.7W); I-(60A); V-(40V)	
12	R1, R2	-	2	ANY	ANY		RESISTOR; 0805; 0 OHM; JUMPER; 0.125W; THICK FILM; FORMFACTOR	
13	R3, R7	-	2	CRCW08051K00FK;ERJ-6ENF1001V; MCR10EZHF1001;RC0805FR-071KL	VISHAY DALE;PANASONIC; ROHM;YAGEO	1K	RESISTOR; 0805; 1K; 1%; 100PPM; 0.125W; THICK FILM	
14	R4-R6	-	3	CRCW08053K92FK; MCR10EZHF3921	VISHAY DALE;ROHM	3.92K	RESISTOR; 0805; 3.92K OHM; 1%; 100PPM; 0.125W; THICK FILM	
15	SU1-SU6	-	6	STC02SYAN	SULLINS ELECTRONICS CORP.	STC02SYAN	TEST POINT; JUMPER; STR; TOTAL LENGTH=0.256IN; BLACK; INSULATION=PBT CONTACT=PHOSPHOR BRONZE; COPPER PLATED TIN OVERALL	
16	TB1, TB2	-	2	282836-2	TE CONNECTIVITY	282836-2	CONNECTOR; FEMALE; THROUGH HOLE; TERMINAL BLOCK; SIDE WIRE ENTRY; STACKING WITH INTERLOCK STRAIGHT; 2PINS ;	
17	TP1, TP5, TP7, TP15, TP16	-	5	5010	KEYSTONE	N/A	TESTPOINT WITH 1.80MM HOLE DIA, RED, MULTIPURPOSE;	
18	TP2, TP4, TP8, TP10, TP14	-	5	5011	KEYSTONE	N/A	TEST POINT; PIN DIA=0.125IN; TOTAL LENGTH=0.445IN; BOARD HOLE=0.063IN; BLACK; PHOSPHOR BRONZE WIRE SILVER PLATE FINISH;	
19	TP3	-	1	5119	KEYSTONE	N/A	TEST POINT; PIN DIA=0.1IN; TOTAL LENGTH=0.3IN; BOARD HOLE=0.04IN; PURPLE; PHOSPHOR BRONZE WIRE SILVER PLATE FINISH;	
20	TP6	-	1	5004	KEYSTONE	N/A	TEST POINT; PIN DIA=0.1IN; TOTAL LENGTH=0.3IN; BOARD HOLE=0.04IN; YELLOW; PHOSPHOR BRONZE WIRE SILVER PLATE FINISH;	
21	TP9	-	1	5000	KEYSTONE	N/A	TEST POINT; PIN DIA=0.1IN; TOTAL LENGTH=0.3IN; BOARD HOLE=0.04IN; RED; PHOSPHOR BRONZE WIRE SILVER PLATE FINISH;	
22	TP11	-	1	5116	KEYSTONE	N/A	TEST POINT; PIN DIA=0.1IN; TOTAL LENGTH=0.3IN; BOARD HOLE=0.04IN; GREEN; PHOSPHOR BRONZE WIRE SILVER PLATE FINISH;	
23	TP12	-	1	5117	KEYSTONE	N/A	TEST POINT; PIN DIA=0.1IN; TOTAL LENGTH=0.3IN; BOARD HOLE=0.04IN; BLUE; PHOSPHOR BRONZE WIRE SILVER PLATE FINISH;	
24	TP13	-	1	5003	KEYSTONE	N/A	TEST POINT; PIN DIA=0.1IN; TOTAL LENGTH=0.3IN; BOARD HOLE=0.04IN; ORANGE; PHOSPHOR BRONZE WIRE SILVER PLATE FINISH;	
25	U1	-	1	MAX20330EWA+	MAXIM	MAX20330EWA+	EVKIT PART - IC; DET; PROGRAMMABLE OVP CONTROLLER WITH VBUS SHORT DETECTION; MAX20330; PACKAGE OUTLINE: 21-100229; PACKAGE CODE: W81B1+1; WLP8	
26	PCB	-	1	MAX20330	MAXIM	PCB	PCB:MAX20330	
27	Q2	DNP	0	SISA72DN-T1-GE3	VISHAY SILICONIX	SISA72DN-T1-GE3	TRAN; NCH; POWERPAK1212-8; PD-(3.7W); I-(60A); V-(40V)	DNI
TOTAL			49					

MAX20330 EV Kit Schematic

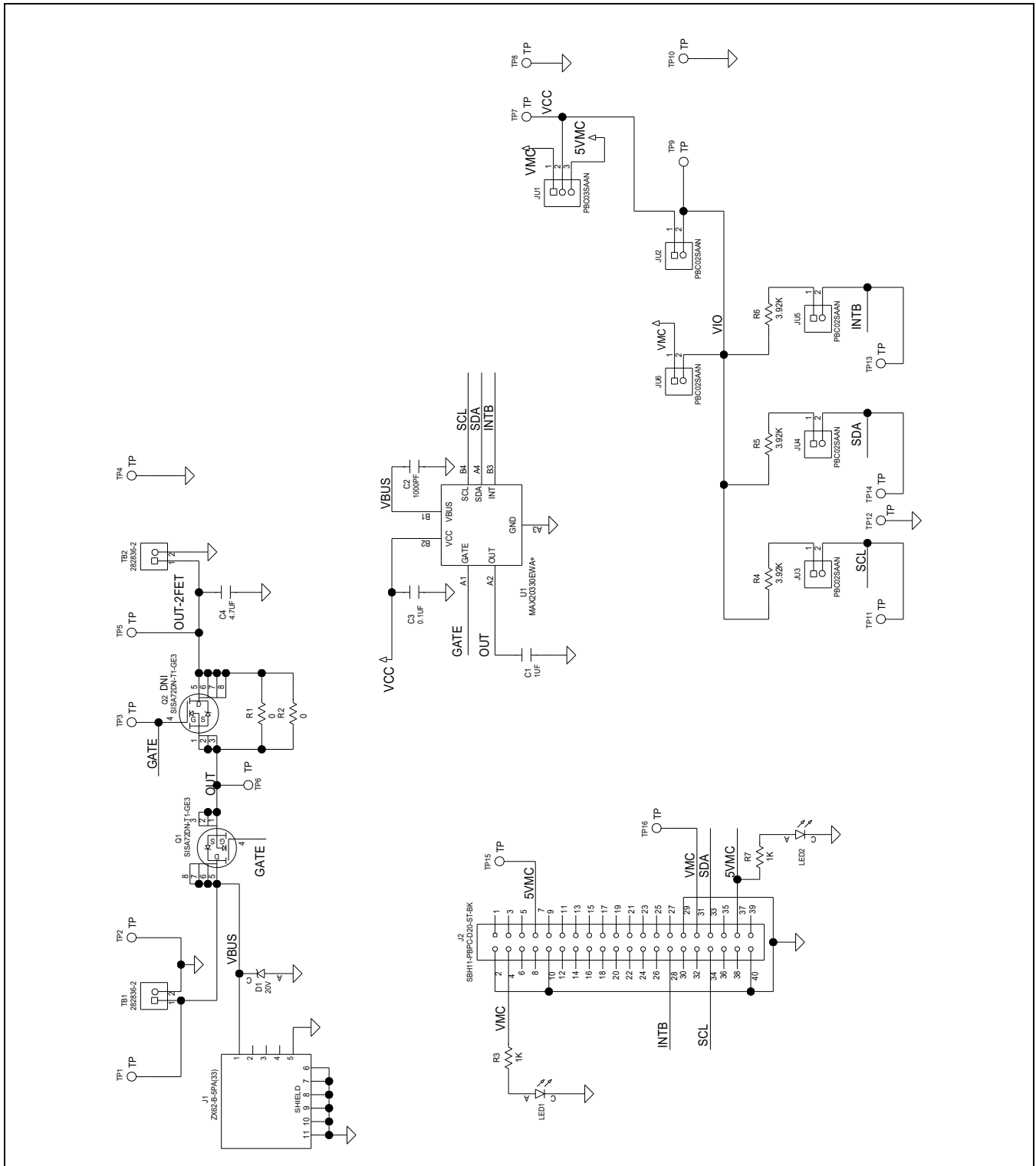

MAX20330 EV PCB Layout Diagrams

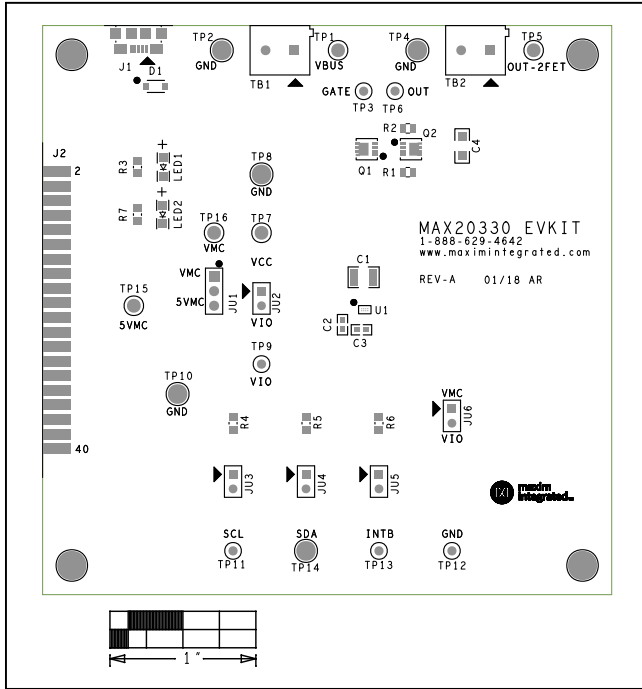

MAX20330 EV Kit—Top Silkscreen

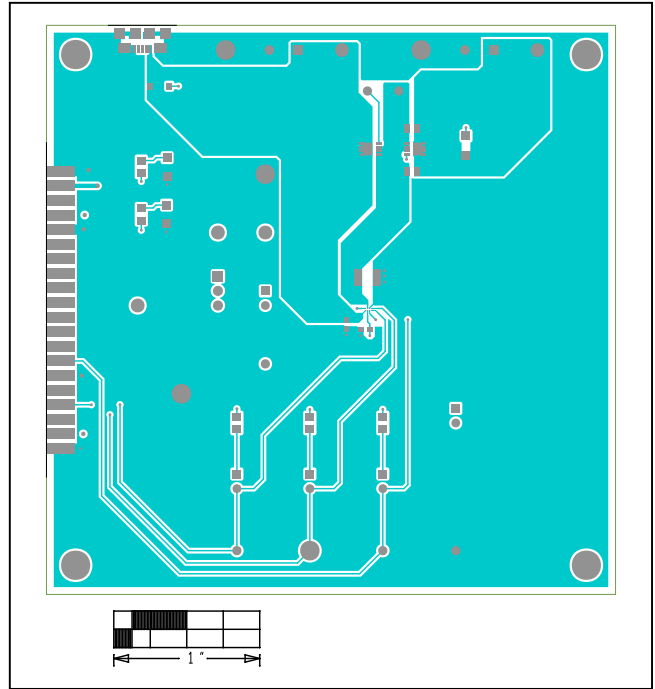

MAX20330 EV Kit—Top

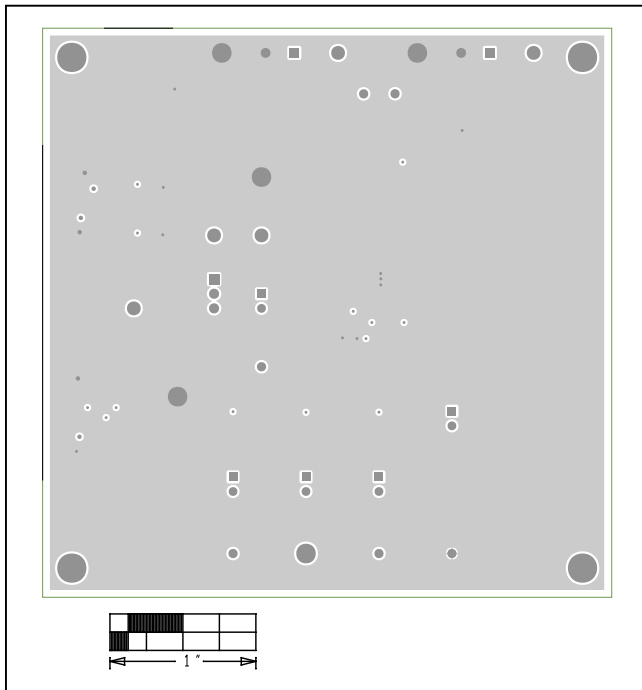

MAX20330 EV Kit—Internal 2

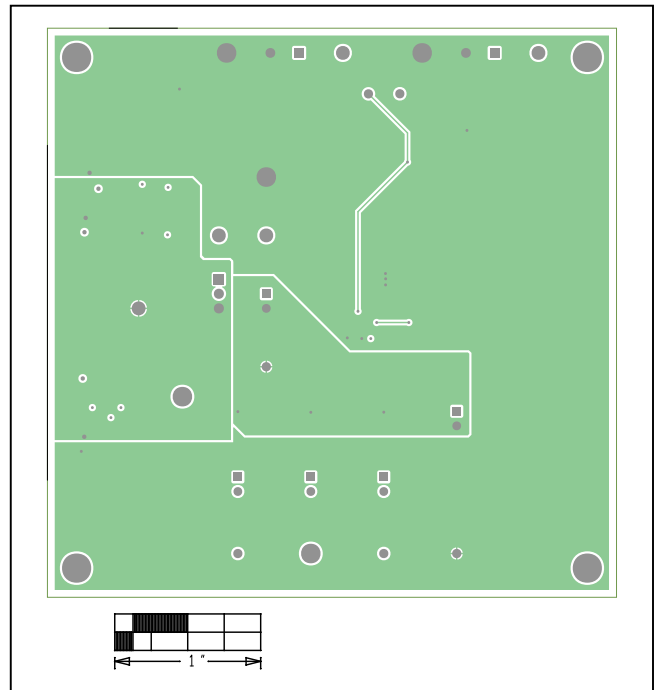

MAX20330 EV Kit—Internal 3

MAX20330 EV PCB Layout Diagrams (continued)

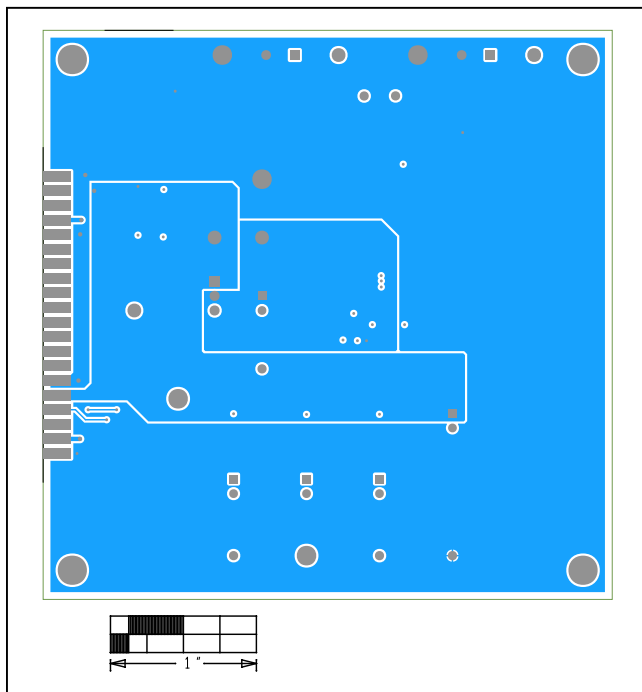

MAX20330 EV Kit—Bottom

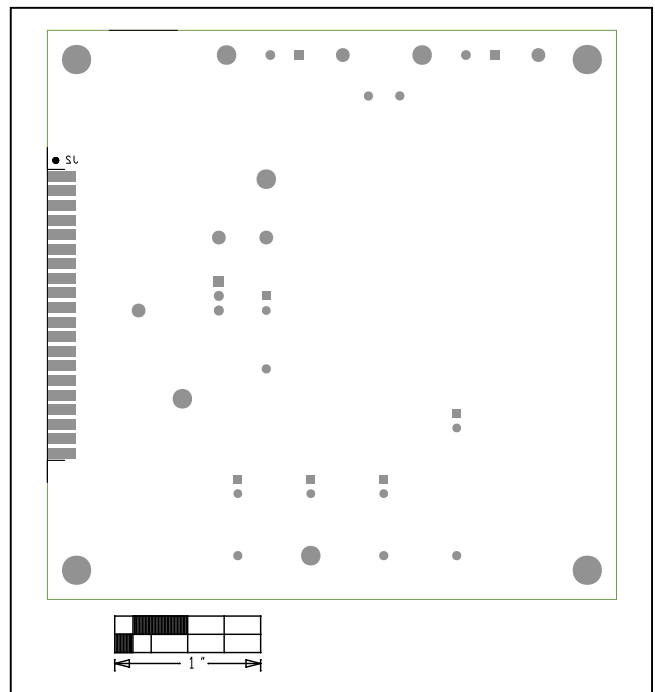

MAX20330 EV Kit—Bottom Silkscreen