

## MAX20333

## Adjustable Current-Limit Switch with Low-Power Mode

### General Description

The MAX20333/A/B/C/D/E/F/G/H/I/J/K/L/M/N programmable current-limit switches feature internal current limiting to prevent damage to host devices due to faulty load conditions. These current limit switches feature a low 23m $\Omega$  (typ) on-resistance and operate from a +3.5V to +22V input voltage range (MAX20333/A/B/C/D/E/F/G/H/I/J/K), or +3.3V to +22V input voltage range (MAX20333L/M/N).

The MAX20333 family has three working modes: normal mode (NM), high current mode (HCM), and low power mode (LPM). In NM, the device offers a programmable current-limit protection from 0.2A to 4.75A. The current-limit threshold can be programmed by connecting a suitable resistor to the SET1 bump. When the current reaches the programmed threshold, the part prevents the current to further increase. The device can react in three different ways while in current limit: autoretry, latching, and continuous. The voltage on the SET1 bump is proportional to the current flowing out of the OUT bump at any time and can be read by an ADC.

In high current mode (HCM), the current-limit threshold is multiplied by two, with an internal upper limit set at 5.5A. The voltage on SET1 is proportional to the current flowing into IN, but multiplied by a factor 0.5. In low power mode (LPM), the current consumption of the part is dramatically reduced, and the on-resistance is 420m $\Omega$  (typ), while still offering an overcurrent protection. The switch is open when the current flowing through the switch exceeds 0.4A (typ).

The devices are available in a 15-bump (2.1mm x 1.52mm) WLP package and operate over the -40°C to +85°C extended temperature range.

### Applications

- USB Port Protection Switch
- Battery Disconnect Switch
- General Power Supply Switch

### Benefits and Features

- Flexible Operation
  - Wide Range of Programmable Current Limit (0.2A to 4.75A)
  - Wide Operating Range: 3.5V to 22V (MAX20333/A/B/C/D/E/F/G/H/I/J/K), 3.3V to 22V (MAX20333L/M/N)
  - Three Different Current-Limit Modes: NM, HCM, LPM
  - Three Different Current-Limit Behaviors: Autoretry, Latching, Continuous
  - Power Good Input
  - Current Monitoring
- Safe Operation
  - Precision Current Limit
  - Output Short Protection
  - Thermal Protection
  - Flag Output
- UL 2367 Recognized—File No. E211395
  - MAX20333/A/F/G Only
  - 4.9A/100W Maximum
- Power Saving
  - Low Power Mode (LPM) with Output Short Protection

[Ordering Information](#) appears at end of data sheet.

Simplified Block Diagram

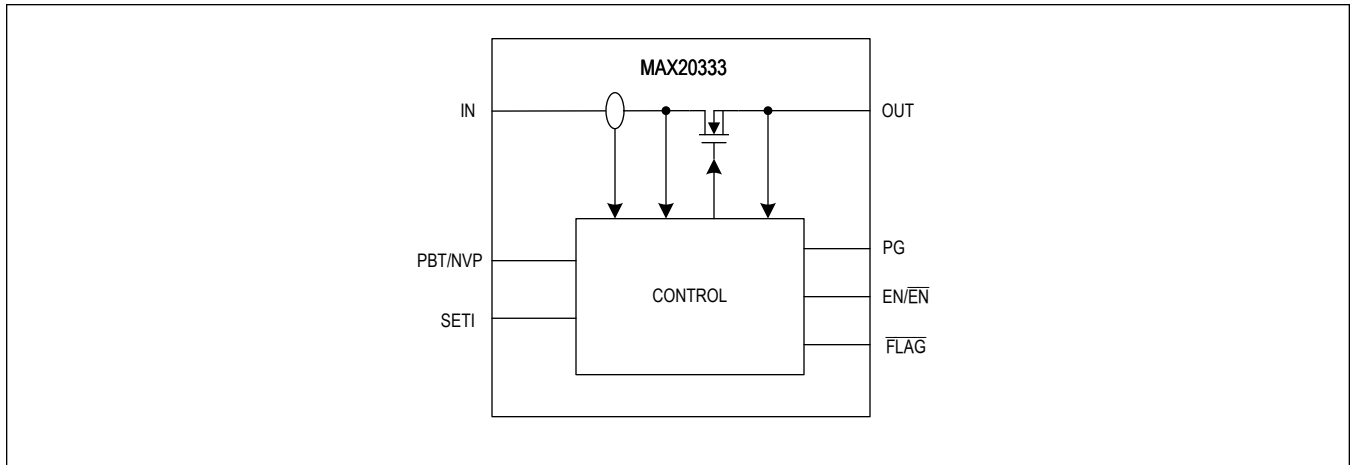

## Absolute Maximum Ratings

(All voltages referenced to GND.)		Current into any bump (except IN, OUT)	20mA
IN	-0.3V to +24V	Current into IN, OUT	6A
IN to OUT	-0.3V to +24V	Continuous Power Dissipation ( $T_A = +70^\circ\text{C}$ )	
OUT	-0.3V to +24V	WLP (derate 16.22mW/°C above +70°C)	1297mW
NVP	max(-0.3V, $V_{IN} - 14\text{V}$ ) to ( $V_{IN} + 0.3\text{V}$ )	Operating Temperature Range	-40°C to +85°C
PBT	-0.3 to ( $V_{IN} + 0.3\text{V}$ )	Junction Temperature	+150°C
FLAG, EN, $\overline{\text{EN}}$ , PG	-0.3V to +6V	Storage Temperature Range	-65°C to +150°C
SET1 (Note 1)	-0.3V to +1.6V	Soldering Temperature (reflow)	+260°C

Stresses beyond those listed under "Absolute Maximum Ratings" may cause permanent damage to the device. These are stress ratings only, and functional operation of the device at these or any other conditions beyond those indicated in the operational sections of the specifications is not implied. Exposure to absolute maximum rating conditions for extended periods may affect device reliability.

## Package Information

### 15 WLP

Package Code	N151A2+1
Outline Number	<a href="#">21-100295</a>
Land Pattern Number	Refer to <a href="#">Application Note 1891</a>
<b>THERMAL RESISTANCE, FOUR-LAYER BOARD</b>	
Junction to Ambient ( $\theta_{JA}$ )	61.65° C/W

For the latest package outline information and land patterns (footprints), go to [www.maximintegrated.com/packages](http://www.maximintegrated.com/packages). Note that a "+", "#", or "-" in the package code indicates RoHS status only. Package drawings may show a different suffix character, but the drawing pertains to the package regardless of RoHS status.

Package thermal resistances were obtained using the method described in JEDEC specification JESD51-7, using a four-layer board. For detailed information on package thermal considerations, refer to [www.maximintegrated.com/thermal-tutorial](http://www.maximintegrated.com/thermal-tutorial).

**Note 1:** SET1 is internally clamped. Forcing more than 5mA current into the bump can damage the device.

## Electrical Characteristics

( $V_{IN} = 3.5\text{V to }22\text{V}$  (MAX20333/A/B/C/D/E/F/G/H/I/J/K),  $V_{IN} = 3.3\text{V to }22\text{V}$  (MAX20333L/M/N),  $T_A = -40^\circ\text{C to }+85^\circ\text{C}$ , unless otherwise noted. Typical values are at  $V_{IN} = 9\text{V}$ ,  $T_A = +25^\circ\text{C}$ ,  $C_{IN} = C_{OUT} = 1\mu\text{F}$ ) (Note 2)

PARAMETER	SYMBOL	CONDITIONS	MIN	TYP	MAX	UNITS
<b>SUPPLY OPERATION</b>						
Operating Voltage	$V_{IN}$	MAX20333/A/B/C/D/E/F/G/H/I/J/K	3.5		22	V
		MAX20333L/M/N	3.3		22	
Quiescent Current Normal Mode, High Current Mode	$I_Q$	EN = high or $\overline{\text{EN}}$ = low, $I_{OUT} = 0\text{A}$ , $V_{IN} = 9\text{V}$		0.9	1.2	mA
Quiescent Current Low Power Mode		EN = low or $\overline{\text{EN}}$ = high, PG = high, $I_{OUT} = 0\text{A}$ , $V_{IN} = 9\text{V}$		13	25	$\mu\text{A}$
Quiescent Current Low Power Mode in Fault		Low Power mode, $V_{IN} = 9\text{V}$ , $V_{OUT} = 0\text{V}$		4	7	$\mu\text{A}$
Latchoff Current	$I_{LATCH}$	EN = high or $\overline{\text{EN}}$ = low, $I_{OUT} = 0\text{A}$ , $V_{IN} = 9\text{V}$ , after an overcurrent fault (MAX20333/A/F/G/L)		4	7	$\mu\text{A}$

## Electrical Characteristics (continued)

( $V_{IN} = 3.5V$  to  $22V$  (MAX20333/A/B/C/D/E/F/G/H/I/J/K),  $V_{IN} = 3.3V$  to  $22V$  (MAX20333L/M/N),  $T_A = -40^\circ C$  to  $+85^\circ C$ , unless otherwise noted. Typical values are at  $V_{IN} = 9V$ ,  $T_A = +25^\circ C$ ,  $C_{IN} = C_{OUT} = 1\mu F$ ) (Note 2)

PARAMETER	SYMBOL	CONDITIONS	MIN	TYP	MAX	UNITS
Shutdown Forward Current	$I_{SHDN}$	EN = low, $\overline{EN}$ = high, $V_{PG} = 0V$ , $V_{IN} = 9V$ , $V_{OUT} = 0V$		2.0	3.5	$\mu A$
Internal POR		MAX20333/A/B/C/D/E/F/G/H/I/J/K	Rise		3.4	V
			Fall	2.7		
		MAX20333L/M/N	Rise		3.2	
			Fall	2.5		
<b>INTERNAL FET</b>						
Switch-On Resistance, Normal Mode, High Current Mode	$R_{ON}$	$V_{IN} = 5V$ , $I_{OUT} = 200mA$ (lower than $I_{LIM}$ ), $T_A = 25^\circ C$		23	30	$m\Omega$
		$T_A = 85^\circ C$			36	
Switch-On Resistance, Low Power Mode	$R_{ONLPM}$	Low Power mode, $I_{OUT} = 20mA$ , $V_{IN} = 9V$ , $T_A = 25^\circ C$	0.30	0.42	0.54	$\Omega$
Forward Current Limit	$I_{LIM}$	$R_{SET1} = 421\Omega$	4607	4750	4892	mA
		$R_{SET1} = 2k\Omega$	970	1000	1030	
		$R_{SET1} = 4k\Omega$	480	500	520	
		$R_{SET1} = 10k\Omega$	186	200	214	
		Internally-set current limit in High Current Mode	5280	5500	5720	
Forward Current Limit in Low Power Mode		Low Power mode	200		700	mA
Current Fold-Back		3A, $R_{SET1} = 667\Omega$	-12	-5		%
		5A, $R_{SET1} = 400\Omega$	-15	-1.6		
Current-Limit Overshoot		$V_{IN} = 9V$ , $C_{LOAD} = 0\mu F$ , $I_{LOAD}$ ramping with $I_{SLOPE} = 1A/ms$ slew rate.		13		%
Current-Limit Reaction Time	$t_{LIM}$	$V_{IN} = 9V$ , $C_{LOAD} = 0\mu F$ , $I_{LOAD}$ ramping with slope $1A/ms$ . Current outside 5% of regulation value.		110		$\mu s$
FLAG Assertion Drop Voltage Threshold	$V_{FA}$	Increase ( $V_{IN} - V_{OUT}$ ) drop until $\overline{FLAG}$ asserts, $I_{OUT}$ limiting, $V_{IN} = 9V$ . Not valid in Low Power mode.	350	425	500	mV
OUT Shutdown Detection Threshold	$V_{SD\_THR}$	Low Power mode, increase ( $V_{IN} - V_{OUT}$ ) drop until $\overline{FLAG}$ asserts	140	165	190	mV
<b>SET1</b>						
Current Mirror Output Ratio	$C_{IRATIO}$	$I_{OUT}/I_{SET1}$	Normal Mode	1333		A/A
			High Current Mode	2666		
$C_{RSET1} \times C_{ILIM}/C_{IRATIO}$	$V_{RI}$		1.47	1.50	1.53	V
Internal SET1 Clamp		5mA into SET1		1.8	2.0	V
SET1 Leakage Current		$V_{SET1} = 1.6V$	-1		+1	$\mu A$
SET1 Offset Current		$V_{IN} = 22V$ , $I_{OUT} = 0A$ , $V_{SET1} = 0V$	0	17	34	$\mu A$

**Electrical Characteristics (continued)**

( $V_{IN} = 3.5V$  to  $22V$  (MAX20333/A/B/C/D/E/F/G/H/I/J/K),  $V_{IN} = 3.3V$  to  $22V$  (MAX20333L/M/N),  $T_A = -40^\circ C$  to  $+85^\circ C$ , unless otherwise noted. Typical values are at  $V_{IN} = 9V$ ,  $T_A = +25^\circ C$ ,  $C_{IN} = C_{OUT} = 1\mu F$ ) (Note 2)

PARAMETER	SYMBOL	CONDITIONS	MIN	TYP	MAX	UNITS
<b>EN, <math>\overline{EN}</math>, PG LOGIC INPUTS</b>						
EN, $\overline{EN}$ Input Logic High			1.4			V
EN, $\overline{EN}$ Input Logic Low					0.4	V
EN, $\overline{EN}$ , PG Leakage Current		0V - 5.5V	-1		+1	$\mu A$
PG Input Threshold High		EN = low, $\overline{EN}$ = high			1.4	V
		EN = high, $\overline{EN}$ = low	1.455	1.500	1.545	
PG Input Threshold Low		EN = low, $\overline{EN}$ = high	0.4			V
		EN = high, $\overline{EN}$ = low	1.358	1.400	1.442	
<b>FLAG OUTPUT</b>						
$\overline{FLAG}$ Output Logic Low Voltage		$I_{SINK} = 1mA$			0.15	V
$\overline{FLAG}$ Output Leakage Current		$\overline{FLAG}$ deasserted	-1		+1	$\mu A$
<b>NVP OUTPUT (MAX20333A/C/E/G/I/K)</b>						
NVP Clamp Voltage	$V_{NVP\_CLAMP}$	$V_{IN} - V_{NVP}$ when $V_{IN} = 22V$	13	15	17	V
NVP Pulldown Current		$V_{IN} = V_{NVP} = 22V$	150	270	400	$\mu A$
<b>PBT (MAX20333/B/D/F/H/J/L/M/N)</b>						
PBT Pullup Current		$V_{PBT} < 2V$	4.5	5.0	5.5	$\mu A$
PBT Input Threshold		Rising	1.40	1.47	1.54	V
<b>DYNAMIC</b>						
Turn-On Time	$t_{SS}$	Time from ENABLE signal to $V_{OUT} = 90\%$ of $V_{IN} = 9V$ , $R_L = 1k\Omega$ , $C_L = 0nF$		0.8		ms
Turn-Off Time	$t_{OFF}$	Time from DISABLE signal to $V_{OUT} = 10\%$ of $V_{IN} = 9V$ , $R_L = 1k\Omega$ , $C_L = 0nF$		20		$\mu s$
Short-Circuit Limit Reaction Time	$t_{SC}$	$V_{IN} = 9V$ , short circuit applied in normal current, high current, and low power mode		1		$\mu s$
Blanking Time Accuracy		MAX20333/B/D/F/H/J/L/M/N (PBT version)	-10		+10	%
Minimum Programmable Blanking Time		MAX20333/B/D/F/H/J/L/M/N (PBT version), $C_{PBT} = 0pF$		350		$\mu s$
Maximum Programmable Blanking Time		MAX20333/B/D/F/H/J/L/M/N (PBT version), PBT = GND	450	500	550	ms
Blanking Time	$t_{BLANK}$	MAX20333A/C/E/G/I/K (NVP version)	9.3	10.3	11.3	ms
Autoretry/Blanking Ratio		MAX20333B/H/M		30		
Autoretry Time	$t_{RETRY}$	MAX20333C/I	278	309	340	ms

Electrical Characteristics (continued)

( $V_{IN} = 3.5V$  to  $22V$  (MAX20333/A/B/C/D/E/F/G/H/I/J/K),  $V_{IN} = 3.3V$  to  $22V$  (MAX20333L/M/N),  $T_A = -40^{\circ}C$  to  $+85^{\circ}C$ , unless otherwise noted. Typical values are at  $V_{IN} = 9V$ ,  $T_A = +25^{\circ}C$ ,  $C_{IN} = C_{OUT} = 1\mu F$ ) (Note 2)

PARAMETER	SYMBOL	CONDITIONS	MIN	TYP	MAX	UNITS
Low Power Mode Transition Time		Transition normal mode/high current mode to low power mode		100		$\mu s$
		Transition low power mode to normal mode/ high current mode		600		
<b>THERMAL PROTECTION</b>						
Thermal Shutdown	$T_{SHDN}$	High current mode, normal mode		150		$^{\circ}C$
Thermal Hysteresis	$T_{HYST}$	High current mode, normal mode		15		$^{\circ}C$

**Note 2:** All devices are 100% production tested at  $T_A = +25^{\circ}C$ . Specifications over the operating temperature range are guaranteed by design.

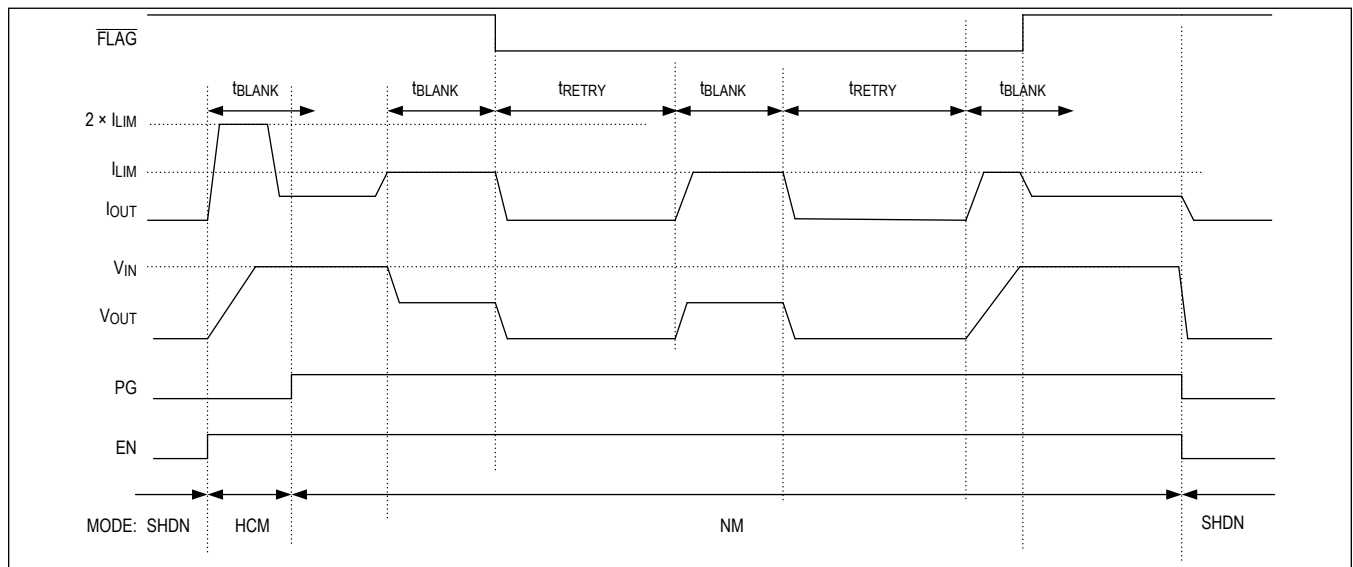

Figure 1. Autoretry



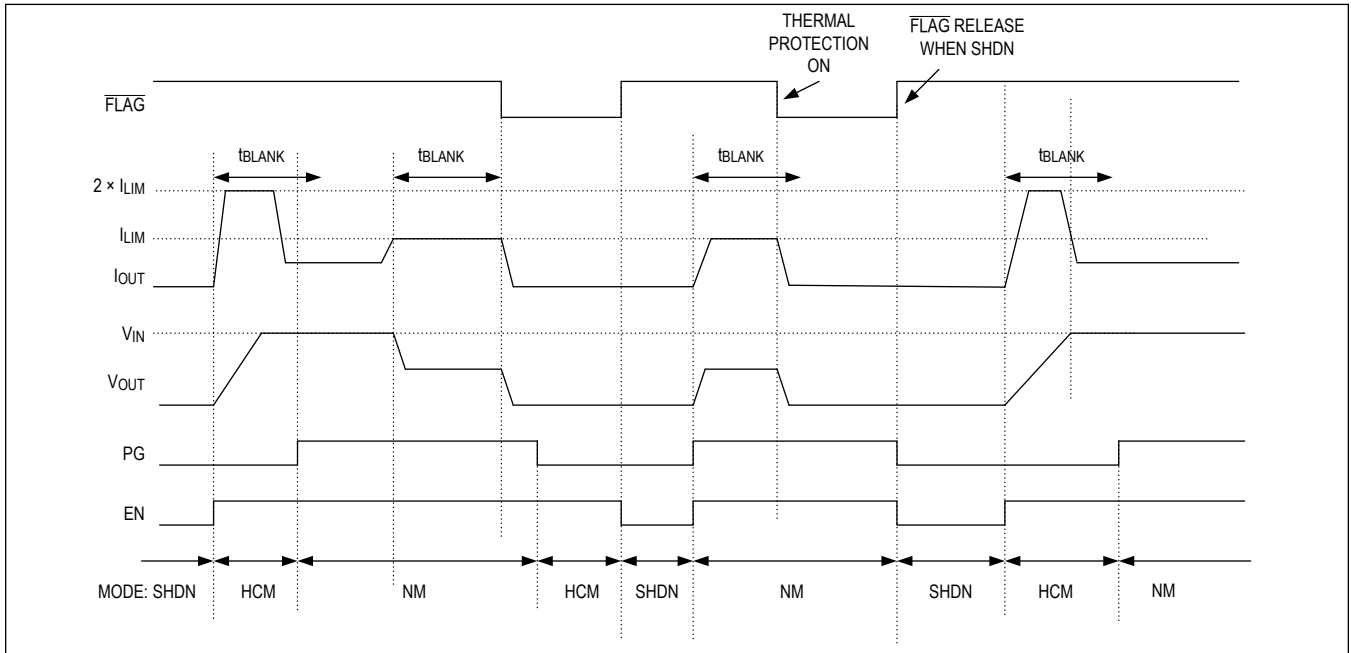

Figure 4. Latchoff

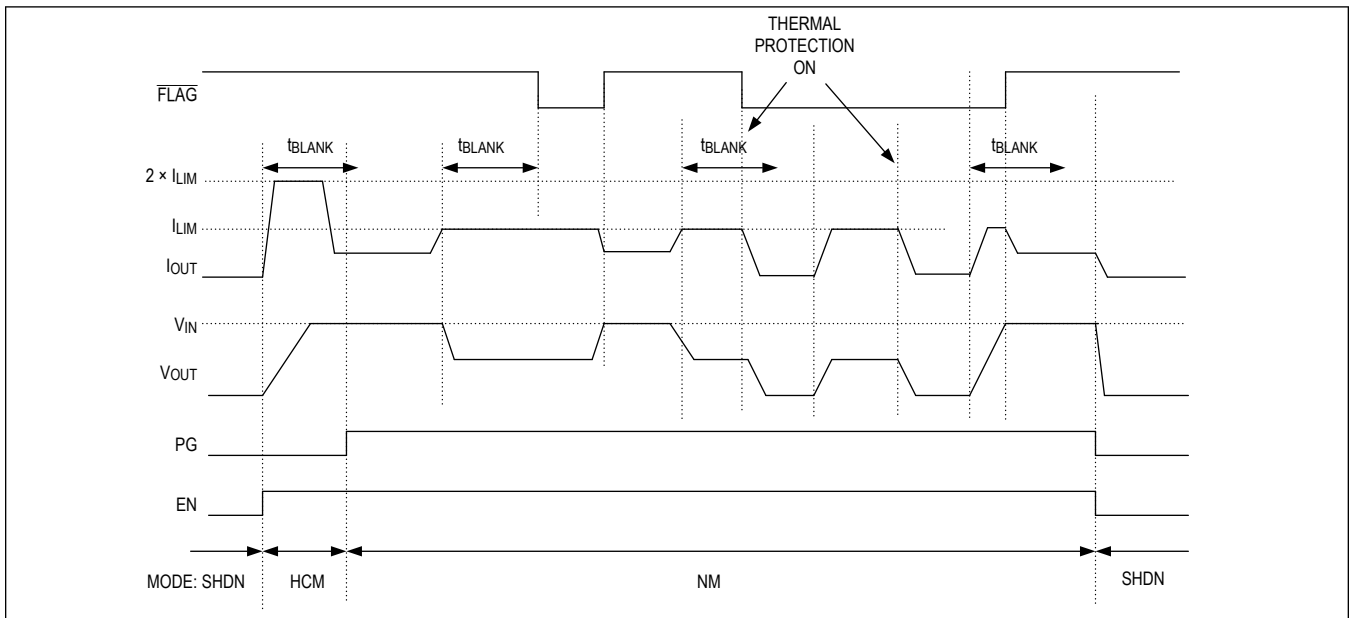

Figure 5. Continuous



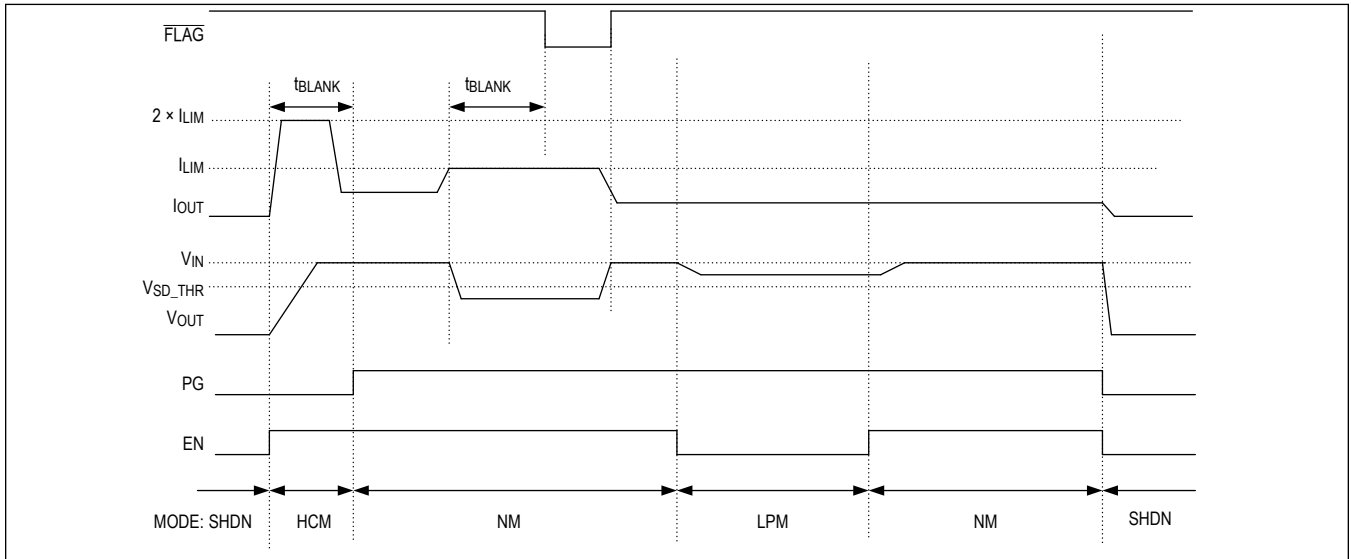
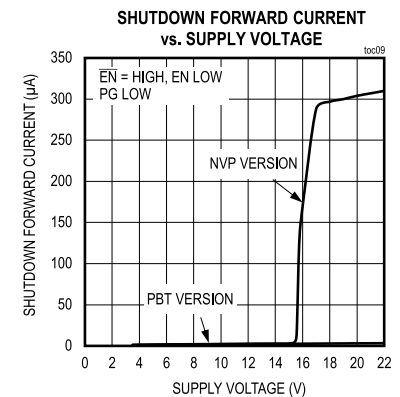
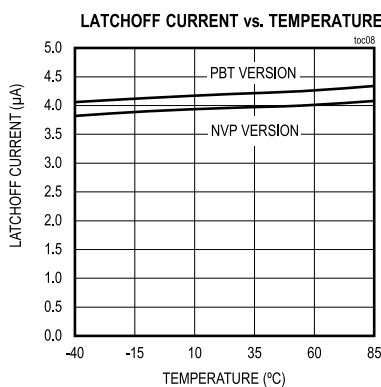
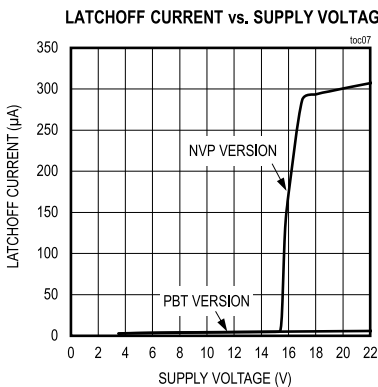
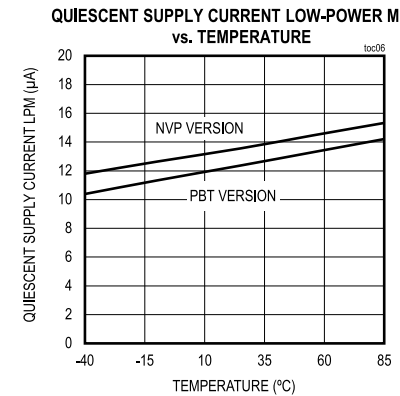
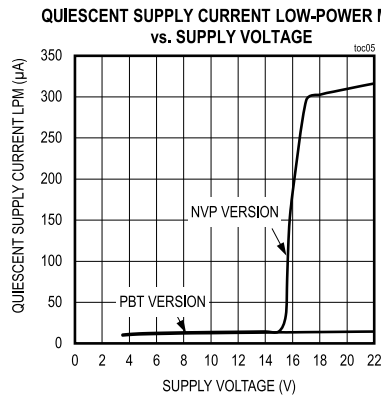
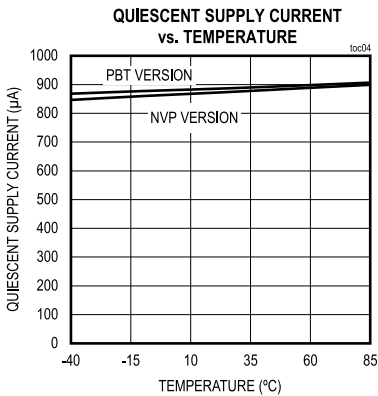
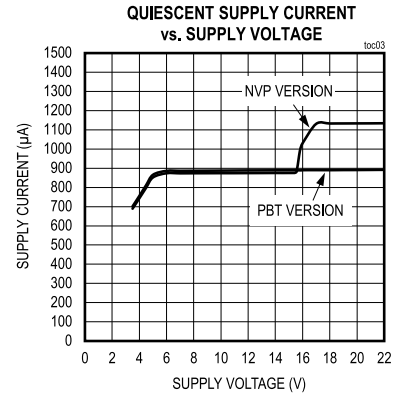
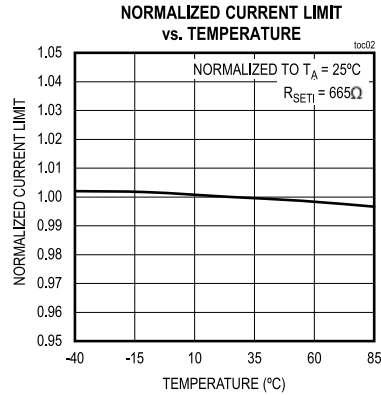
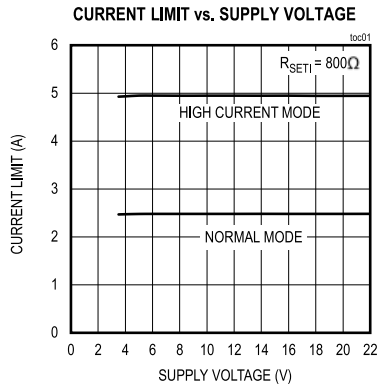

Figure 6. Continuous and Low Power Mode

Typical Operating Characteristics

( $V_{IN} = 9V$ ,  $C_{IN} = C_{OUT} = 1\mu F$ ,  $T_A = +25^\circ C$ , unless otherwise noted.)



Typical Operating Characteristics (continued)

( $V_{IN} = 9V$ ,  $C_{IN} = C_{OUT} = 1\mu F$ ,  $T_A = +25^\circ C$ , unless otherwise noted.)

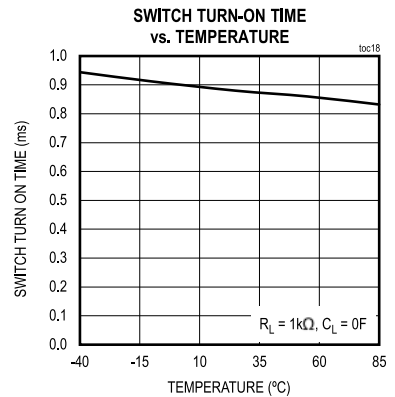
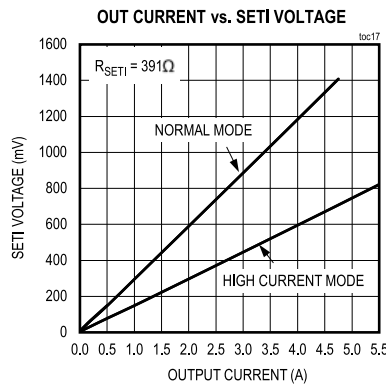
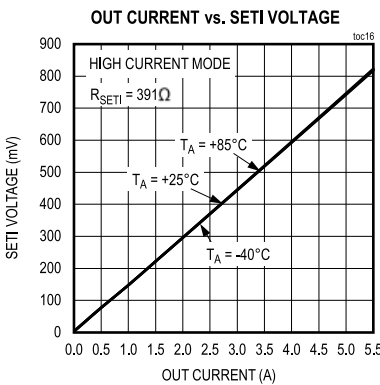
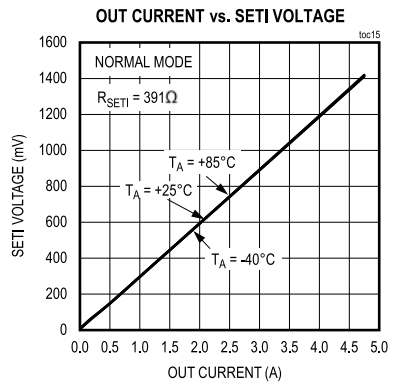
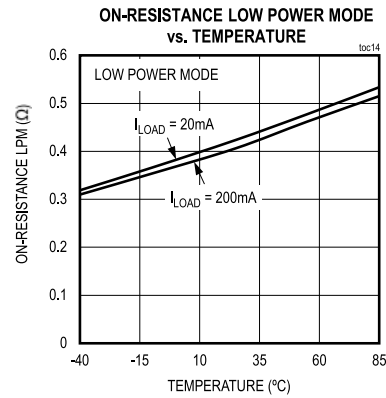
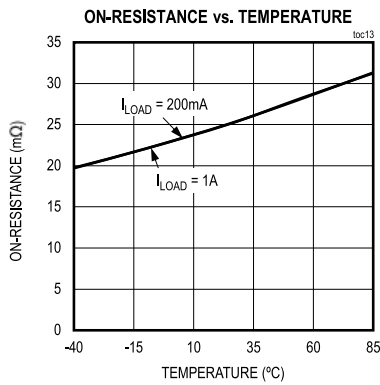
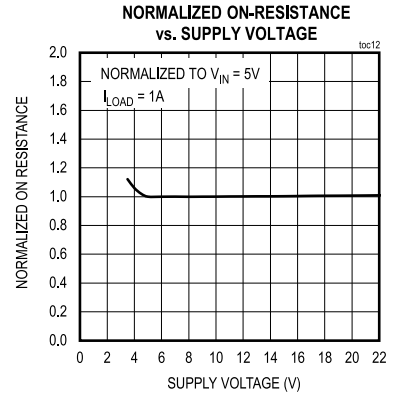
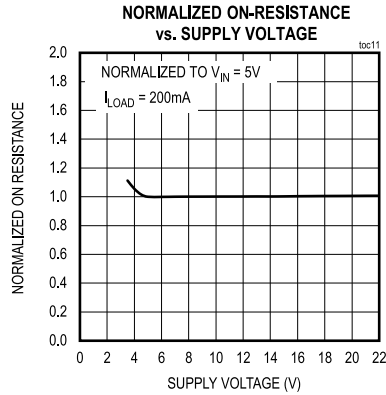
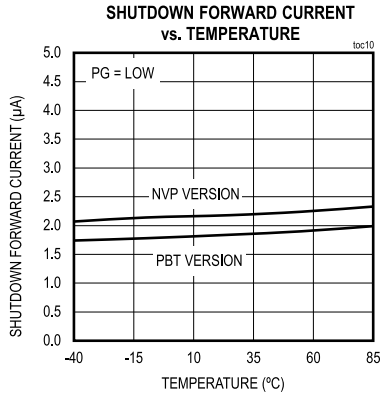

Typical Operating Characteristics (continued)

( $V_{IN} = 9V$ ,  $C_{IN} = C_{OUT} = 1\mu F$ ,  $T_A = +25^\circ C$ , unless otherwise noted.)

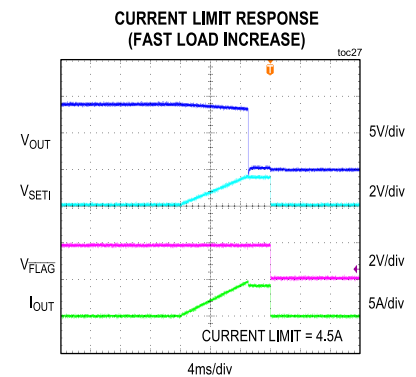
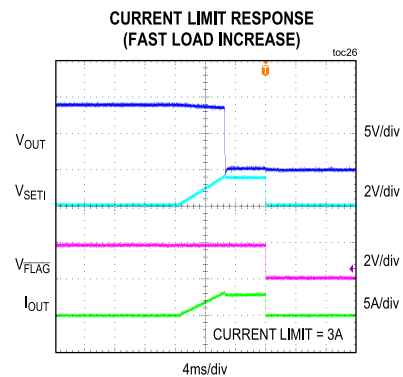
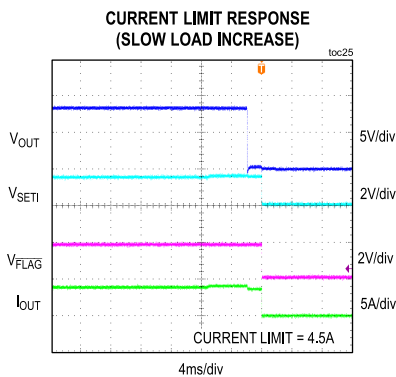
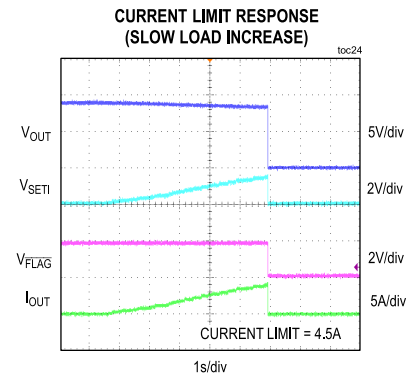
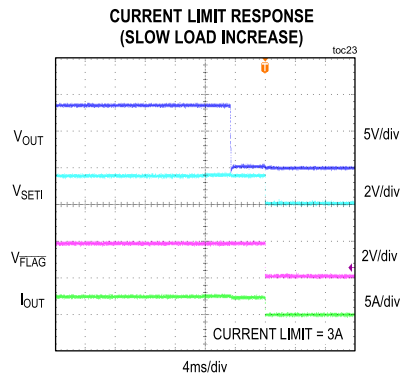
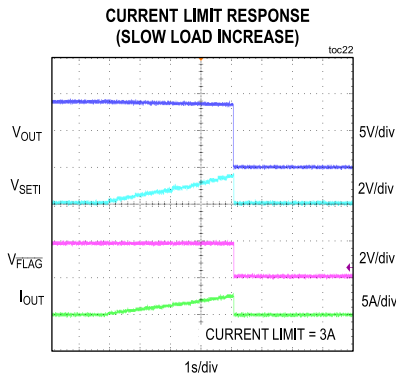
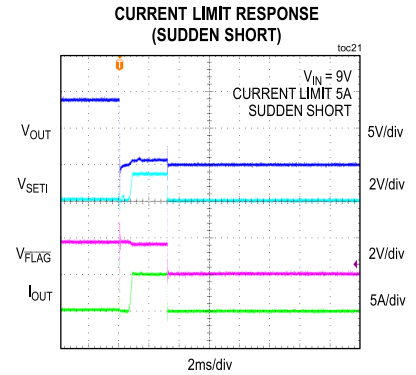
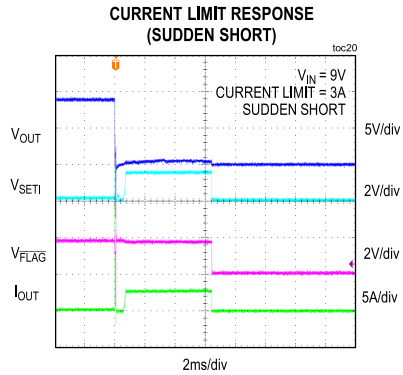
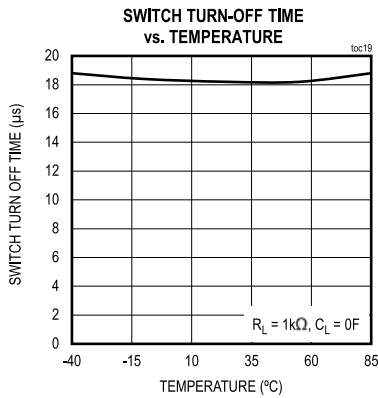

Bump Configurations

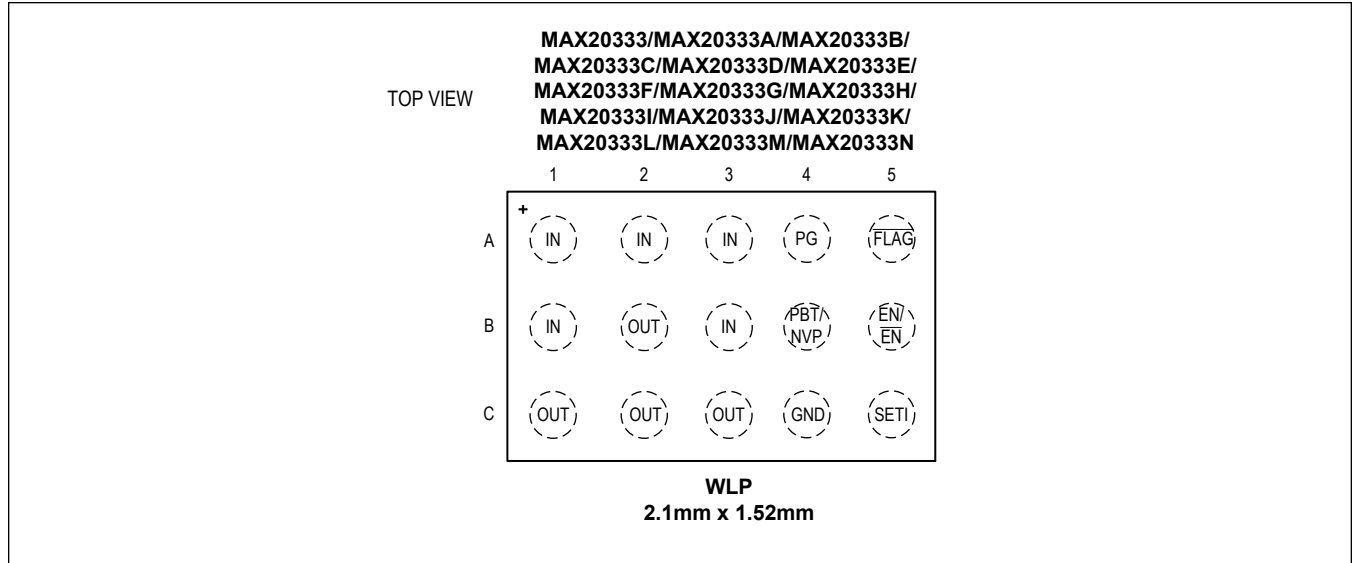

Bump Description

		PIN			NAME	FUNCTION
MAX20333/ B/D	MAX20333A/ C/E	MAX20333F/ H/J	MAX20333G/ I/K	MAX20333L/ M/N		
A1, A2, A3, B1, B3	A1, A2, A3, B1, B3	A1, A2, A3, B1, B3	A1, A2, A3, B1, B3	A1, A2, A3, B1, B3	IN	Power Input. Connect IN together and bypass IN to GND with a 1µF ceramic capacitor as close to the device as possible.
A4	A4	A4	A4	A4	PG	Power Good Input. Use PG and EN/EN to select the current limit modes. See Table 1.
A5	A5	A5	A5	A5	FLAG	Open Drain Flag Output. FLAG is driven low when the overload fault duration exceeds the blanking time (normal or high current mode), thermal shutdown is active, or SETI is connected to ground. In low power mode, the blanking time is ignored and FLAG is immediately asserted. Additionally there is no thermal shutdown in low power mode.
B2, C1, C2, C3	B2, C1, C2, C3	B2, C1, C2, C3	B2, C1, C2, C3	B2, C1, C2, C3	OUT	Switch Output. Connect OUT together and bypass OUT to GND with a 1µF ceramic capacitor as close as possible to the device.
B4	-	B4	-	B4	PBT	Programmable Blanking Time. Connect a capacitor C <sub>PBT</sub> to set the overcurrent blanking time.

## Bump Description (continued)

PIN					NAME	FUNCTION
MAX20333/ B/D	MAX20333A/ C/E	MAX20333F/ H/J	MAX20333G/ I/K	MAX20333L/ M/N		
-	B4	-	B4	-	NVP	External p-FET Gate Drive for Negative Input Protection
B5	B5	-	-	-	EN	Active High Enable Input
-	-	B5	B5	B5	$\overline{\text{EN}}$	Active Low Enable Input
C4	C4	C4	C4	C4	GND	Ground
C5	C5	C5	C5	C5	SETI	Overload Current Limit Adjust and Current Monitor. $V_{\text{SETI}}$ is proportional to $I_{\text{OUT}}$ . Connect a resistor $R_{\text{SETI}}$ from SETI to GND to program the overcurrent limit. If $R_{\text{SETI}} < 350\Omega$ , the switch turns off and FLAG is asserted. If SETI is unconnected the current limit is at 0mA. To ensure stability, the total capacitance on SETI should not exceed 20pF.

## Detailed Description

The MAX20333 family provides adjustable precision unidirectional current limit and low power mode. The device has three current limit modes, high current mode (HCM), normal current mode (NM), and low power mode (LPM); three current limit behaviors, autoretry, latching, and continuous; and, two enables, active high (EN), or active low ( $\overline{\text{EN}}$ ).

### Current-Limit Mode

The MAX20333 family has three different current limit modes: high current mode, normal current mode, and low power mode. Use EN/ $\overline{\text{EN}}$  and PG to select the current limit mode ([Table 1](#)).

### High Current Mode (HCM)

In HCM, the current limit is internally set at twice the normal limit. In case the high current limit  $2 \times I_{\text{LIM}}$  exceeds 5.5A, the current limit is automatically set at 5.5A.

Selection between high current mode and normal current mode is made by the PG bump. The PG bump can be used as a power-good input by connecting it to OUT through a voltage divider. Note the PG bump has no clamp, so the user needs to make sure its voltage never exceeds 5.5V.

### Normal Current Mode (NM)

In NM, the current limit threshold is defined by a resistor from SET1 to GND that sets the current-limit threshold for the switch (see the Setting the Current-Limit Threshold section). If the output current is limited at the current threshold value for a time equal to, or longer than,  $t_{\text{BLANK}}$  with  $V_{\text{IN}} - V_{\text{OUT}}$  higher than the  $\overline{\text{FLAG}}$  assertion drop-voltage threshold ( $V_{\text{FA}}$ ), the  $\overline{\text{FLAG}}$  asserts, and the device enters autoretry-/latching-/continuous-current mode.

**Table 1. Functional Truth Table**

MAX20333/A/B/C/D/E		
EN	PG	MODE
Low	Low	Shutdown (SHDN)
High	Low	High current (HCM)
High	High	Normal current (NM)
Low	High	Low Power (LPM)
MAX20333F/G/H/I/J/K/L/M/N		
$\overline{\text{EN}}$	PG	MODE
High	Low	Shutdown (SHDN)
Low	Low	High current (HCM)
Low	High	Normal current (NM)
High	High	Low Power (LPM)

### Low Power Mode (LPM)

In LPM, the quiescent current consumption is dramatically reduced by switching off most of the chip functions: current-sense, accurate current limit, thermal protection, and autoretry. The on-resistance becomes  $0.42\Omega$  (typ). Whenever  $V_{\text{IN}} - V_{\text{OUT}} > V_{\text{SD\_THR}}$ , the switch is opened and stays open as long as the LPM is maintained. All devices act as latching when in LPM.  $\overline{\text{EN}}/\overline{\text{EN}}$  or supply cycling is required to enable the switch again. The device latches off if power-up in LPM or go from SHDN to LPM. To avoid spurious faults when transitioning from low power mode to normal mode, the  $R_{\text{SET1}}$  resistor should be selected such that  $R_{\text{SET1}} < 660/I_{\text{LOAD\_LPM}}$  and low power mode should always be active for a minimum of 200 $\mu\text{s}$ .

### Current Limit Fold-Back

The devices feature a natural current limit fold-back behavior once the current limit level is reached. The current limit fold-back value is typically 5% of the current limits set through the SETI resistor.

### Current-Limit Behavior

There are three different behaviors when overcurrent is detected in normal current mode or high current mode: autoretry, latching, and continuous.

### Autoretry Mode

When the current threshold is reached, the  $t_{\text{BLANK}}$  timer begins counting. The  $\overline{\text{FLAG}}$  asserts if the overcurrent condition is present for  $t_{\text{BLANK}}$ . The timer resets if the overcurrent condition disappears before  $t_{\text{BLANK}}$  has elapsed. A retry time delay,  $t_{\text{RETRY}} = 30 \times t_{\text{BLANK}}$ , is started immediately after  $t_{\text{BLANK}}$  has elapsed and during  $t_{\text{RETRY}}$  time, the FET is off. At the end of  $t_{\text{RETRY}}$ , the FET is turned on again. If the fault still exists, the cycle is repeated, and the  $\overline{\text{FLAG}}$  stays low. If the fault is removed, the FET stays on.

The autoretry feature reduces the system power in case of overcurrent or short-circuit conditions. During  $t_{\text{BLANK}}$  time, when the switch is on, the supply current is held at the current limit. During  $t_{\text{RETRY}}$  time, when the switch is off, there is no current through the switch. Thus, the output current is much less than the programmed current limit. Calculate the average output current using the following equation.

$$I_{\text{LOAD}} = I_{\text{LIM}} \left[ \frac{t_{\text{BLANK}}}{t_{\text{BLANK}} + t_{\text{RETRY}}} \right]$$

With a 12ms (typ)  $t_{\text{BLANK}}$  and 360ms (typ)  $t_{\text{RETRY}}$ , the duty cycle is 3.2%, resulting in a 96.8% power saving.

### Latching Mode

When the current threshold is reached, the  $t_{\text{BLANK}}$  timer begins counting. The  $\overline{\text{FLAG}}$  asserts if the overcurrent condition is present for  $t_{\text{BLANK}}$ . The timer resets when the overcurrent condition disappears before  $t_{\text{BLANK}}$  has elapsed. The switch turns off and stays off (latching) if the overcurrent condition continues beyond the blanking time. To reset the switch, either enter shutdown mode or cycle the input voltage. During latching, the current consumption is reduced close to the shutdown level.

### Continuous Mode

When the current threshold is reached, the device limits the output current to the programmed current limit. The  $\overline{\text{FLAG}}$  asserts if the overcurrent condition is present for  $t_{\text{BLANK}}$  and deasserts when the overload condition is removed. In continuous mode, the FET is open only in case of overheating.

### PBT

The MAX20333/B/D/F/H/J/L/M/N have a PBT bump. A trimmed 5 $\mu\text{A}$  current ( $I_{\text{PBT}}$ ) is sourced from the PBT bump. A capacitance  $C_{\text{PBT}}$  is expected to be mounted between PBT and GND. PBT is shorted to ground when the device is not in current limit. Once current limit is detected ( $V_{\text{IN}} - V_{\text{OUT}} > V_{\text{FA}}$ ),  $V_{\text{PBT}}$  starts rising with slope  $I_{\text{PBT}}/C_{\text{PBT}}$ .

A fixed 300 $\mu\text{s}$  delay is added. The external  $t_{\text{BLANK}}$  is limited to 500ms by a watch dog counter. Use the following formula to calculate the blanking time:

$$t_{\text{BLANK}} = \frac{C_{\text{PBT}} \times 1.5}{I_{\text{PBT}}} + 300(\mu\text{s}) = \frac{C_{\text{PBT}} \times 1.5}{5\mu\text{A}} + 300(\mu\text{s})$$

With  $t_{\text{BLANK}} = 100\text{ms}$ ,  $C_{\text{PBT}} = 330\text{nF}$

In autoretry,  $t_{\text{RETRY}} = t_{\text{BLANK}} \times 30$

If the blanking time is shorter than the rise time, the device cannot be powered up and flag is asserted.

The rise time and turn-on time: when EN goes from low to high (or  $\overline{\text{EN}}$  goes from high to low), a 600 $\mu\text{s}$  delay elapses before the switch is turned-on, then OUT rises with an average slope of 30V/ms slope with no load connected.



**NVP**

The MAX20333A/C/E/G/I/K have an NVP bump. The NVP has a voltage clamp for the gate of the p-FET. The NVP bump is always pulled down with 270 $\mu$ A (typ), so the external p-FET is always in the on state even in shutdown mode. The voltage clamp limits the gate-to-source voltage to 15V (typ) when the input is positive. If input goes negative, the p-FET turns off and provides negative voltage protection. When  $V_{IN} > V_{NVP\_CLAMP}$  the pulldown current adds to the chip quiescent current.

**FLAG Output**

The  $\overline{FLAG}$  bump is an open-drain output. In shutdown mode,  $\overline{FLAG}$  is always deasserted.

$\overline{FLAG}$  is asserted in following fault condition:

CONDITION	NORMAL MODE	HIGH CURRENT MODE	LOW POWER MODE
OVERCURRENT	LOW	LOW	–
THERMAL SHUTDOWN	LOW	LOW	–
$V_{IN} - V_{OUT} > V_{SD\_THR}$	–	–	LOW
SET1 IS CONNECTED TO GND	LOW	LOW	LOW

**Thermal Shutdown Protection**

The MAX20333 family features thermal shutdown protection to protect the device from overheating. The device turns off when the junction temperature exceeds +150°C (typ). The device exits thermal shutdown and resumes normal operation after the junction temperature cools by 15°C (typ). During thermal shutdown, the switch is open. There is no thermal protection in low power mode. The latchoff version latches off after a thermal shutdown event.

## Applications Information

### Setting The Current-Limit Threshold and Current Monitoring

Connect a resistor between SET1 and ground to program the current limit threshold value for the devices. [Table 2](#) shows current limit thresholds for different resistor values at SET1. Use the following formula to calculate the current limit:

$$I_{LIM}(A) = \frac{V_{RI}(V)}{R_{SET1}(\Omega)} \times C_{IRATIO} = \frac{1.5V}{R_{SET1}(\Omega)} \times C_{IRATIO} = \frac{2000V(\text{normal mode})}{R_{SET1}(\Omega)}$$

Do not use a  $R_{SET1}$  value smaller than 350Ω.

Where,  $C_{IRATIO} = 1333$  in NM and  $C_{IRATIO} = 2666$  in HCM

The voltage ( $V_{SET1}$ ) read on the SET1 bump can be interpreted as the output current as below:

$$I_{OUT}(A) = \frac{V_{SET1}(V) \times C_{IRATIO}}{R_{SET1}(\Omega)} = I_{SET1}(A) \times C_{IRATIO}$$

**Table 2. Current-Limit Threshold vs. Resistor Values**

$R_{SET1}(\Omega)$	CURRENT LIMIT (A) NORMAL MODE	CURRENT LIMIT (A) HIGH CURRENT MODE
10000	0.2	0.4
4000	0.5	1
2000	1	2
1333	1.5	3
1000	2	4
800	2.5	5
666	3	5.5
571	3.5	5.5
500	4	5.5
444	4.5	5.5
421	4.75	5.5

### IN Bypass Capacitor

Connect a minimum 1μF capacitor from IN to GND to limit the input voltage drop during momentary output short-circuit conditions. If the power supply cannot support the required short-circuit current, a larger capacitor should be used to maintain the input voltage above 3.5V.

### OUT Bypass Capacitor

For stable operation over the full temperature range and over the full programmable current-limit range, use a 1μF ceramic capacitor from OUT to ground.

Excessive output capacitance can cause a false overcurrent condition due to decreased dV/dt across the capacitor. Use the following formula to calculate the maximum capacitive load ( $C_{MAX}$ ) on OUT:

$$C_{MAX}(\mu F) = \frac{I_{LIM}(mA) \times t_{BLANK(MIN)}(ms)}{V_{IN}(V)}$$

For example, for  $V_{IN} = 10V$ ,  $t_{BLANK(MIN)} = 11.4ms$ , and for  $I_{LIM} = 1000mA$ ,  $C_{MAX} = 1140\mu F$ .

### Layout and Thermal Dissipation

To optimize the switch response time to output short-circuit conditions, it is very important to keep all traces as short as possible to reduce the effect of undesirable parasitic inductance. Place input and output capacitors as close as possible

to the device (should be no more than 5mm). IN and OUT must be connected with wide short traces to the power bus. During normal operation, the power dissipation is small and the package temperature change is minimal. If the output is continuously shorted to ground, the power dissipation for the MAX20333 continuous current limit version can cause the device to reach the thermal shutdown threshold.

Typical Application Circuits

MAX20333

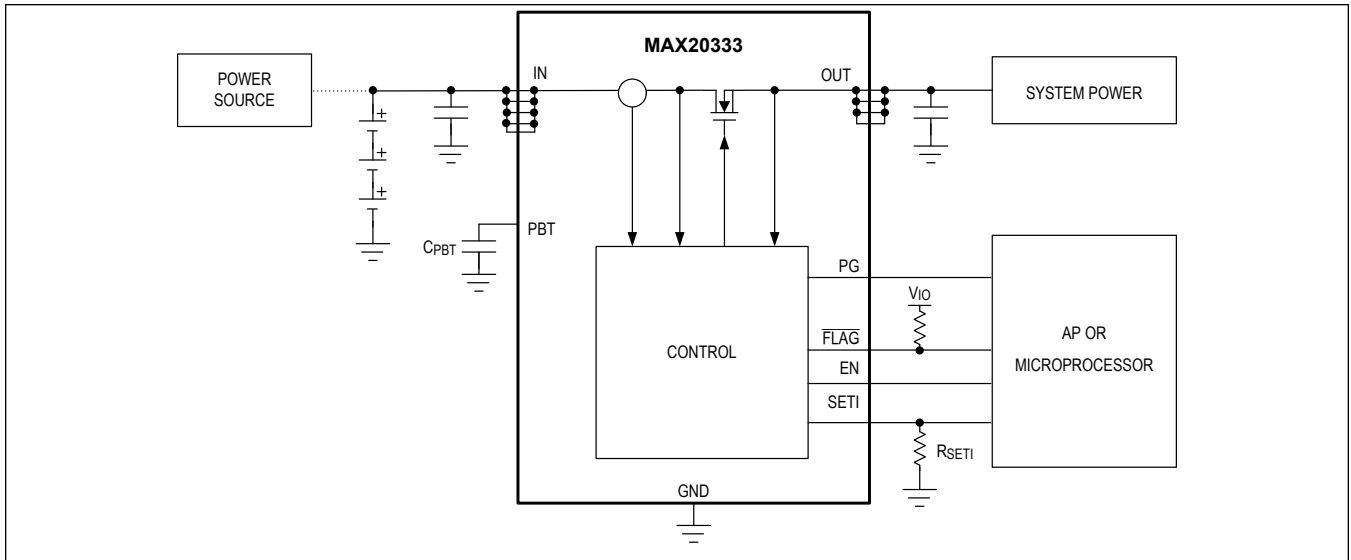

MAX20333A

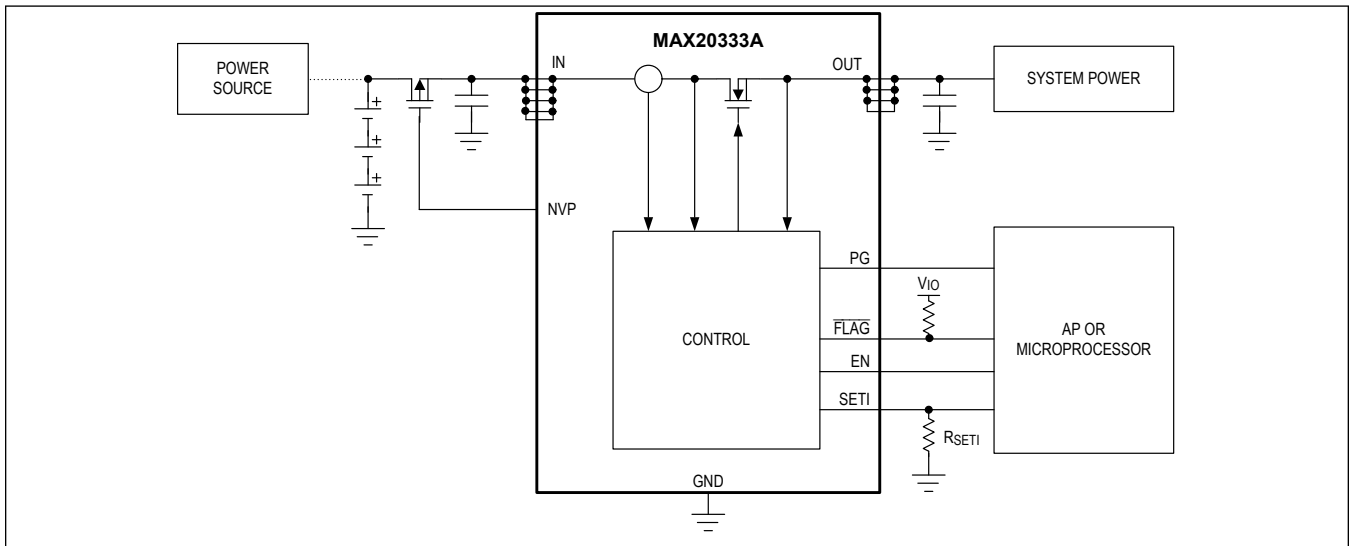

## Ordering Information

PART	EN/ $\overline{\text{EN}}$	CURRENT LIMIT TYPE	PBT/NVP	INPUT VOLTAGE	TEMP RANGE	PIN-PACKAGE
MAX20333ENL+T	EN	LATCHOFF	PBT	3.5V TO 22V	-40°C TO +85°C	15 WLP
MAX20333AENL+T*	EN	LATCHOFF	NVP	3.5V TO 22V	-40°C TO +85°C	15 WLP
MAX20333BENL+T*	EN	AUTORETRY	PBT	3.5V TO 22V	-40°C TO +85°C	15 WLP
MAX20333CENL+T	EN	AUTORETRY	NVP	3.5V TO 22V	-40°C TO +85°C	15 WLP
MAX20333DENL+T	EN	CONTINUOUS	PBT	3.5V TO 22V	-40°C TO +85°C	15 WLP
MAX20333EENL+T*	EN	CONTINUOUS	NVP	3.5V TO 22V	-40°C TO +85°C	15 WLP
MAX20333FENL+T	$\overline{\text{EN}}$	LATCHOFF	PBT	3.5V TO 22V	-40°C TO +85°C	15 WLP
MAX20333GENL+T	$\overline{\text{EN}}$	LATCHOFF	NVP	3.5V TO 22V	-40°C TO +85°C	15 WLP
MAX20333HENL+T*	$\overline{\text{EN}}$	AUTORETRY	PBT	3.5V TO 22V	-40°C TO +85°C	15 WLP
MAX20333IENL+T*	$\overline{\text{EN}}$	AUTORETRY	NVP	3.5V TO 22V	-40°C TO +85°C	15 WLP
MAX20333JENL+T*	$\overline{\text{EN}}$	CONTINUOUS	PBT	3.5V TO 22V	-40°C TO +85°C	15 WLP
MAX20333KENL+T*	$\overline{\text{EN}}$	CONTINUOUS	NVP	3.5V TO 22V	-40°C TO +85°C	15 WLP
MAX20333LENL+T*	$\overline{\text{EN}}$	LATCHOFF	PBT	3.3V TO 22V	-40°C TO +85°C	15 WLP
MAX20333MENL+T	$\overline{\text{EN}}$	AUTORETRY	PBT	3.3V TO 22V	-40°C TO +85°C	15 WLP
MAX20333NENL+T*	$\overline{\text{EN}}$	CONTINUOUS	PBT	3.3V TO 22V	-40°C TO +85°C	15 WLP

+ Denotes lead(Pb)-free/RoHS-compliant package.

T = Tape and reel.

\*Future product—contact factory for availability.