

Click [here](#) to ask about the production status of specific part numbers.

## MAX20353

# PMIC with Ultra-Low I<sub>q</sub> Regulators, Charger, Fuel Gauge, and Haptic Driver for Small Li+ Systems

### General Description

The MAX20353 is a highly integrated and programmable power management solution designed for ultra-low-power wearable applications. It is optimized for size and efficiency to enhance the value of the end product by extending battery life and shrinking the overall solution size. A flexible set of power-optimized voltage regulators, including multiple bucks, boost, buck-boost, and linear regulators, provides a high level of integration and the ability to create a fully optimized power architecture. The quiescent current of each regulator is specifically suited for 1 $\mu$ A (typ) to extend battery life in always-on applications.

The MAX20353 includes a complete battery management solution with battery seal, charger, power path, and fuel gauge. Both thermal management and input protection are built into the charger.

The device also includes a factory programmable button controller with multiple inputs that are customizable to fit specific product UX requirements.

Three integrated LED current sinks are included for indicator or backlighting functions, and an ERM/LRA driver with automatic resonance tracking is capable of providing sophisticated haptic feedback to the user.

The device is configurable through an I<sup>2</sup>C interface that allows for programming various functions and reading device status, including the ability to read temperature and supply voltages with the integrated ADC.

This device is available in a 56-bump, 0.5mm pitch 3.71mm x 4.21mm, wafer-level package (WLP) and operates over the -40°C to +85°C extended temperature range.

### Applications

- Wearable Devices
- IoT

**Ordering Information** appears at end of data sheet.

### Benefits and Features

- Extend Battery Use Time Between Battery Charging
  - 2 x Micro-I<sub>Q</sub> Buck Regulators (<1 $\mu$ A I<sub>Q</sub> (typ) Each)
    - 350mA Output
    - Buck1: 0.7V to 2.275V in 25mV Steps
    - Buck2: 0.7V to 3.85V in 50mV Steps
  - Micro-I<sub>Q</sub> LV LDO/Load Switch (1 $\mu$ A I<sub>Q</sub> (typ))
    - 1.16V to 2.0V Input Voltage
    - 50mA Output
    - 0.5V to 1.95V Output, 25mV Steps
  - Micro-I<sub>Q</sub> LDO/Load Switch (1 $\mu$ A I<sub>Q</sub> (typ))
    - 1.71V to 5.5V Input Voltage
    - 100mA Output
    - 0.9V to 4V, 100mV Steps
  - Micro-I<sub>Q</sub> Buck-Boost Regulator (1.3 $\mu$ A I<sub>Q</sub> (typ))
    - 250mW Output
    - 2.5V to 5V in 100mV Steps
- Easy-to-Implement Li+ Battery Charging
  - Wide Fast Charge Current Range: 5mA to 500mA
  - Smart Power Selector
    - 28V/-5.5V Tolerant Input
    - Programmable JEITA Current/Voltage Profiles
- Minimize Solution Footprint Through High Integration
  - Safe Output LDO
    - 15mA When CHGIN Present
    - 5V or 3.3V
  - Haptic Driver
    - ERM/LRA Driver with Quick Start And Stored Pattern RAM
    - Automatic Resonance Tracking (LRA only)
    - Closed Loop Automatic Braking (LRA only)
- Support Wide Variety of Display Options
  - Micro-I<sub>Q</sub> Boost Regulator (2.4 $\mu$ A I<sub>Q</sub> (typ))
    - 300mW Output
    - 5V to 20V in 250mV Step
  - 3 Channel Current Sinks
    - 20V Tolerant
    - Programmable from 0.6 to 30mA
- Optimize System Control
  - Power-On/Reset Controller
  - Programmable Push-Button Controller
  - Programmable Supply Sequencing
  - Factory Shelf Mode
  - On-Chip Voltage Monitor Multiplexer and Analog-to-Digital Converter (ADC)

**TABLE OF CONTENTS**

|   |    |
|---|----|
| General Description . . . . .                             | 1  |
| Applications . . . . .                                    | 1  |
| Benefits and Features . . . . .                           | 1  |
| Absolute Maximum Ratings . . . . .                        | 12 |
| Package Information . . . . .                             | 12 |
| Electrical Characteristics . . . . .                      | 13 |
| Typical Operating Characteristics . . . . .               | 34 |
| Bump Configuration . . . . .                              | 40 |
| Bump Description . . . . .                                | 41 |
| Typical Application Diagram . . . . .                     | 43 |
| Detailed Description . . . . .                            | 44 |
| Power Regulation . . . . .                                | 44 |
| Dynamic Voltage Scaling (DVS) . . . . .                   | 44 |
| Power Switch and Reset Control . . . . .                  | 44 |
| Power Sequencing . . . . .                                | 53 |
| Current Sink . . . . .                                    | 54 |
| System Load Switch . . . . .                              | 54 |
| Smart Power Selector . . . . .                            | 54 |
| Input Limiter . . . . .                                   | 54 |
| SAR ADC/Monitor MUX . . . . .                             | 55 |
| JEITA Monitoring with Charger Control . . . . .           | 55 |
| Haptic Driver . . . . .                                   | 55 |
| ERM . . . . .   | 57 |
| LRA . . . . .   | 57 |
| LRA Braking . . . . .                                     | 57 |
| Driver Amplitude . . . . .                                | 57 |
| Automatic Level Compensation . . . . .                    | 57 |
| Haptic UVLO . . . . .                                     | 57 |
| Vibration Timeout . . . . .                               | 58 |
| Overcurrent/Thermal Protection . . . . .                  | 58 |
| Haptic Driver Lock . . . . .                              | 58 |
| Interface Modes . . . . .                                 | 58 |
| Pure-PWM (PPWM) . . . . .                                 | 58 |
| Real-Time I <sup>2</sup> C (RTI <sup>2</sup> C) . . . . . | 58 |
| External Triggered Stored Pattern (ETRG) . . . . .        | 58 |
| RAM Stored Haptic Pattern (RAMHP) . . . . .               | 59 |
| Fuel Gauge . . . . .                                      | 61 |
| ModelGauge Theory of Operation . . . . .                  | 61 |

**TABLE OF CONTENTS (CONTINUED)**

|  |    |
|--|----|
| Fuel-Gauge Performance .....                               | 61 |
| Battery Voltage and State of Charge .....                  | 62 |
| Temperature Compensation .....                             | 62 |
| Impact of Empty-Voltage Selection .....                    | 62 |
| Battery Insertion .....                                    | 62 |
| Battery Insertion Debounce .....                           | 62 |
| Battery Swap Detection .....                               | 62 |
| Quick-Start .....  | 62 |
| Power-On Reset (POR) .....                                 | 62 |
| Hibernate Mode .....                                       | 63 |
| Alert Interrupt .....                                      | 63 |
| Sleep Mode .....   | 63 |
| I <sup>2</sup> C Interface .....                           | 63 |
| Applications Information .....                             | 63 |
| I <sup>2</sup> C Interface .....                           | 63 |
| Start, Stop, And Repeated Start Conditions .....           | 63 |
| Slave Address .....  | 64 |
| Bit Transfer .....   | 64 |
| Single-Byte Write .....                                    | 64 |
| Burst Write .....  | 64 |
| Single Byte Read .....                                     | 65 |
| Burst Read .....   | 66 |
| Acknowledge Bits .....                                     | 66 |
| Application Processor Interface .....                      | 67 |
| AP Write .....   | 67 |
| AP Read .....  | 67 |
| AP Launch .....  | 67 |
| Write-Protected Commands and Fields .....                  | 67 |
| Direct Access I <sup>2</sup> C Register Map .....          | 68 |
| Direct Access I <sup>2</sup> C Register Descriptions ..... | 70 |
| Interrupt Registers .....                                  | 70 |
| Status Registers .....                                     | 71 |
| Interrupt Mask Registers .....                             | 75 |
| AP Interface Registers .....                               | 78 |
| Buck1 DVS Registers .....                                  | 80 |
| LDO Direct Register .....                                  | 81 |
| MPC Direct Registers .....                                 | 81 |
| Haptic Braking Registers .....                             | 83 |

**TABLE OF CONTENTS (CONTINUED)**

|   |     |
|---|-----|
| Haptic RAM Registers .....                    | 84  |
| LED Direct Registers .....                    | 85  |
| Haptic Direct Registers .....                 | 87  |
| AP Command Register Descriptions .....        | 90  |
| GPIO Config Commands .....                    | 90  |
| Input Current Limit Commands .....            | 95  |
| Thermal Shutdown Configuration Commands ..... | 96  |
| Charger Configuration Commands .....          | 97  |
| Boost Configuration Commands .....            | 106 |
| Buck Configuration Commands .....             | 108 |
| LDO Configuration Commands .....              | 114 |
| Charge Pump Configuration Commands .....      | 118 |
| SFOUT Configuration Commands .....            | 119 |
| MON Mux Configuration Commands .....          | 121 |
| Buck-Boost Configuration Commands .....       | 123 |
| Haptic Configuration Commands .....           | 125 |
| Power and Reset Commands .....                | 138 |
| Register Summary .....                        | 141 |
| VCELL Register (0x02) .....                   | 141 |
| SOC Register (0x04) .....                     | 141 |
| MODE Register (0x06) .....                    | 141 |
| VERSION Register (0x08) .....                 | 141 |
| Fuel Gauge I <sup>2</sup> C Registers .....   | 141 |
| HIBRT Register (0x0A) .....                   | 142 |
| CONFIG Register (0x0C) .....                  | 142 |
| VALRT Register (0x14) .....                   | 143 |
| CRATE Register (0x16) .....                   | 143 |
| VRESET/ID Register (0x18) .....               | 143 |
| STATUS Register (0x1A) .....                  | 144 |
| Reset Indicator: .....                        | 144 |
| Alert Descriptors: .....                      | 144 |
| Enable or Disable VRESET Alert: .....         | 144 |
| TABLE Registers (0x40 to 0x7F) .....          | 144 |
| CMD Register (0xFE) .....                     | 144 |
| Ordering Information .....                    | 153 |
| Chip Information .....                        | 153 |
| Revision History .....                        | 154 |

**LIST OF FIGURES**

|   |     |
|---|-----|
| Figure 1a. PwrRstCfg = 0000 or 0001 . . . . .                                   | 45  |
| Figure 1b. PwrRstCfg = 0010 or 0011 . . . . .                                   | 46  |
| Figure 1c. PwrRstCfg = 0100 or 0101 . . . . .                                   | 47  |
| Figure 1d. PwrRstCfg = 0110 . . . . .   | 48  |
| Figure 1e. PwrRstCfg = 0111 . . . . .   | 49  |
| Figure 1f. PwrRstCfg = 1000 . . . . .   | 50  |
| Figure 2. The full MAX20353 Boot Sequence . . . . .                             | 52  |
| Figure 3. Reset Sequence Programming . . . . .                                  | 53  |
| Figure 4a. Sample JEITA Pre Charge Profile . . . . .                            | 55  |
| Figure 4b. Sample JEITA Fast Charge Profile . . . . .                           | 55  |
| Figure 4c. Sample JEITA Maintain Charge Profile . . . . .                       | 56  |
| Figure 5. Charger State Diagram . . . . .                                       | 56  |
| Figure 6. Read and Write Processes for RAM . . . . .                            | 59  |
| Figure 7a. Sample Pattern Stored in RAM . . . . .                               | 61  |
| Figure 7b. Haptic Driver Output of Stored Pattern . . . . .                     | 61  |
| Figure 8. I <sup>2</sup> C START, STOP and REPEATED START Conditions . . . . .  | 63  |
| Figure 9. Write Byte Sequence . . . . .   | 64  |
| Figure 10. Burst Write Sequence . . . . .                                       | 65  |
| Figure 11. Read Byte Sequence . . . . .   | 65  |
| Figure 12. Burst Read Sequence . . . . .  | 66  |
| Figure 13. Acknowledge . . . . .  | 66  |
| Figure 14. Executing a Write Opcode and Reading the MAX20353 Response . . . . . | 67  |
| Figure 15. Executing a Read Opcode and Reading the MAX20353 Response . . . . .  | 67  |
| Figure 16. MODE Register Format . . . . .                                       | 142 |
| Figure 17. HIBRT Register Format . . . . .                                      | 142 |
| Figure 18. CONFIG Register Format . . . . .                                     | 142 |
| Figure 19. VALRT Register Format . . . . .                                      | 143 |
| Figure 20. VRESET/ID Register Format . . . . .                                  | 143 |
| Figure 21. STATUS Register Format . . . . .                                     | 144 |

**LIST OF TABLES**

|   |    |
|---|----|
| Table 1. Buck1 DVS MPC Values .....                       | 44 |
| Table 2. PwrRstCfg Settings .....                         | 51 |
| Table 3. SAR ADC Full-Scale Voltages and Conversions..... | 55 |
| Table 4. RAMHP Pattern Storage Format .....               | 60 |
| Table 5. HardwareID Register (0x00).....                  | 70 |
| Table 6. FirmwareID Register (0x01).....                  | 70 |
| Table 7. Int0 Register (0x03) .....                       | 70 |
| Table 8. Int1 Register (0x04) .....                       | 70 |
| Table 9. Int2 Register (0x05) .....                       | 71 |
| Table 10. Status0 Register (0x06) .....                   | 71 |
| Table 11. Status1 Register (0x07) .....                   | 72 |
| Table 12. Status2 Register (0x08) .....                   | 73 |
| Table 13. Status3 Register (0x09) .....                   | 73 |
| Table 14. SystemError Register (0x0B) .....               | 74 |
| Table 15. IntMask0 Register (0x0C).....                   | 75 |
| Table 16. IntMask1 Register (0x0D).....                   | 76 |
| Table 17. IntMask2 Register (0x0E).....                   | 77 |
| Table 18. APDataOut0 Register (0x0F).....                 | 78 |
| Table 19. APDataOut1 Register (0x10) .....                | 78 |
| Table 20. APDataOut2 Register (0x11) .....                | 78 |
| Table 21. APDataOut3 Register (0x12) .....                | 78 |
| Table 22. APDataOut4 Register (0x13) .....                | 78 |
| Table 23. APDataOut5 Register (0x14) .....                | 79 |
| Table 24. APDataOut6 Register (0x15) .....                | 79 |
| Table 25. APCmdOut Register (0x17) .....                  | 79 |
| Table 26. APResponse Register (0x18).....                 | 79 |
| Table 27. APDataIn0 Register (0x19).....                  | 79 |
| Table 28. APDataIn1 Register (0x1A) .....                 | 79 |
| Table 29. APDataIn2 Register (0x1B) .....                 | 80 |
| Table 30. APDataIn3 Register (0x1C) .....                 | 80 |
| Table 31. APDataIn4 Register (0x1D) .....                 | 80 |
| Table 32. APDataIn5 Register (0x1E) .....                 | 80 |
| Table 33. Buck1I2CDVS Register (0x1F).....                | 80 |
| Table 34. LDODirect Register (0x20).....                  | 81 |
| Table 35. MPCDirectWrite Register (0x21) .....            | 81 |

**LIST OF TABLES (CONTINUED)**

|  |    |
|--|----|
| Table 36. MPCDirectRead Register (0x22) . . . . .      | 82 |
| Table 37. DVSVIt1 Register (0x23) . . . . .            | 82 |
| Table 38. DVSVIt2 Register (0x24) . . . . .            | 82 |
| Table 39. DVSVIt3 Register (0x25) . . . . .            | 83 |
| Table 40. AutoBrkCfg0 Register (0x26) . . . . .        | 83 |
| Table 41. AutoBrkCfg1 Register (0x27) . . . . .        | 84 |
| Table 42. HptRAMAddr Register (0x28) . . . . .         | 84 |
| Table 43. HptRAMDataH Register (0x29) . . . . .        | 84 |
| Table 44. HptRAMDataM Register (0x2A) . . . . .        | 84 |
| Table 45. HptRAMDataL Register (0x2B) . . . . .        | 84 |
| Table 46. LEDStepDirect Register (0x2C) . . . . .      | 85 |
| Table 47. LED0Direct Register (0x2D) . . . . .         | 85 |
| Table 48. LED1Direct Register (0x2E) . . . . .         | 86 |
| Table 49. LED2Direct Register (0x2F) . . . . .         | 86 |
| Table 50. HptDirect0 Register (0x30) . . . . .         | 87 |
| Table 51. HptDirect1 Register (0x31) . . . . .         | 88 |
| Table 52. HptRTI2CAmp Register (0x32) . . . . .        | 89 |
| Table 53. HptPatRAMAddr Register (0x33) . . . . .      | 89 |
| Table 54. 0x01 – GPIO_Config_Write . . . . .           | 90 |
| Table 55. GPIO_Config_Write Response . . . . .         | 91 |
| Table 56. 0x02 – GPIO_Config_Read . . . . .            | 91 |
| Table 57. GPIO_Config_Read Response . . . . .          | 91 |
| Table 58. 0x03 – GPIO_Control_Write . . . . .          | 91 |
| Table 59. GPIO_Control_Write Response . . . . .        | 92 |
| Table 60. 0x04 – GPIO_Control_Read . . . . .           | 92 |
| Table 61. GPIO_Control_Read Response . . . . .         | 92 |
| Table 62. 0x06 – MPC_Config_Write . . . . .            | 92 |
| Table 63. MPC_Config_Write Response . . . . .          | 94 |
| Table 64. 0x07 – MPC_Config_Read . . . . .             | 94 |
| Table 65. MPC_Config_Read Response . . . . .           | 94 |
| Table 66. 0x10 – InputCurrent_Config_Write . . . . .   | 95 |
| Table 67. InputCurrent_Config_Write Response . . . . . | 95 |
| Table 68. 0x11 – InputCurrent_Config_Read . . . . .    | 95 |
| Table 69. InputCurrent_Config_Read Response . . . . .  | 96 |
| Table 70. 0x12 – ThermalShutdown_Config_Read . . . . . | 96 |

**LIST OF TABLES (CONTINUED)**

|  |     |
|--|-----|
| Table 71. ThermalShutdown_Config_Read Response . . . . .       | 96  |
| Table 72. 0x14 – Charger_Config_Write . . . . .                | 97  |
| Table 73. Charger_Config_Write Response . . . . .              | 99  |
| Table 74. 0x15 – Charger_Config_Read . . . . .                 | 99  |
| Table 75. Charger_Config_Read Response . . . . .               | 99  |
| Table 76. 0x16 – ChargerThermalLimits_Config_Write . . . . .   | 100 |
| Table 77. ChargerThermalLimits_Config_Write Response . . . . . | 100 |
| Table 78. 0x17 – ChargerThermalLimits_Config_Read . . . . .    | 100 |
| Table 79. ChargerThermalLimits_Config_Read Response . . . . .  | 101 |
| Table 80. 0x18 – ChargerThermalReg_Config_Write . . . . .      | 101 |
| Table 81. ChargerThermalReg_Config_Write Response . . . . .    | 104 |
| Table 82. 0x19 – ChargerThermalReg_Config_Read . . . . .       | 104 |
| Table 83. ChargerThermalReg_Config_Read Response . . . . .     | 104 |
| Table 84. 0x1A – Charger_ControlWrite . . . . .                | 104 |
| Table 85. Charger_ControlWrite Response . . . . .              | 104 |
| Table 86. 0x1B – Charger_ControlRead . . . . .                 | 105 |
| Table 87. Charger_Control_Read Response . . . . .              | 105 |
| Table 88. 0x1C – Charger_JEITAHyst_ControlWrite . . . . .      | 105 |
| Table 89. Charger_JEITAHyst_ControlWrite Response . . . . .    | 105 |
| Table 90. Charger_JEITAHyst_ControlRead . . . . .              | 105 |
| Table 91. Charger_JEITAHyst_ControlRead Response . . . . .     | 105 |
| Table 92. 0x30 – Bst_Config_Write . . . . .                    | 106 |
| Table 93. Bst_Config_Write Response . . . . .                  | 107 |
| Table 94. 0x31 – Bst_Config_Read . . . . .                     | 107 |
| Table 95. Bst_Config_Read Response . . . . .                   | 107 |
| Table 96. 0x35 – Buck1_Config_Write . . . . .                  | 108 |
| Table 97. Buck1_Config_Write Response . . . . .                | 109 |
| Table 98. 0x36 – Buck1_Config_Read . . . . .                   | 109 |
| Table 99. Buck1_Config_Read Response . . . . .                 | 110 |
| Table 100. 0x37 – Buck1_DVSConfig_Write . . . . .              | 110 |
| Table 101. Buck1_DVSConfig_Write Response . . . . .            | 111 |
| Table 102. 0x3A – Buck2_Config_Write . . . . .                 | 111 |
| Table 103. Buck2_Config_Write Response . . . . .               | 112 |
| Table 104. 0x3B – Buck2_Config_Read . . . . .                  | 112 |
| Table 105. Buck2_Config_Read Response . . . . .                | 113 |



**LIST OF TABLES (CONTINUED)**

|   |     |
|---|-----|
| Table 106. 0x3C – Buck2_DVSCfg_Write . . . . .        | 113 |
| Table 107. Buck2_DVSCfg_Write Response . . . . .      | 114 |
| Table 108. 0x40 – LDO1_Config_Write . . . . .         | 114 |
| Table 109. LDO1_Config_Write Response . . . . .       | 115 |
| Table 110. 0x41 – LDO1_Config_Read . . . . .          | 115 |
| Table 111. LDO1_Config_Read Response . . . . .        | 115 |
| Table 112. 0x42 – LDO2_Config_Write . . . . .         | 116 |
| Table 113. LDO2_Config_Write Response . . . . .       | 117 |
| Table 114. 0x43 – LDO2_Config_Read . . . . .          | 117 |
| Table 115. LDO2_Config_Read Response . . . . .        | 117 |
| Table 116. 0x46 – ChargePump_Config_Write . . . . .   | 118 |
| Table 117. ChargePump_Config_Write Response . . . . . | 118 |
| Table 118. 0x47 – ChargePump_Config_Read . . . . .    | 118 |
| Table 119. ChargePump_Config_Read Response . . . . .  | 119 |
| Table 120. 0x48 – SFOUT_Config_Write . . . . .        | 119 |
| Table 121. SFOUT_Config_Write Response . . . . .      | 120 |
| Table 122. 0x49 – SFOUT_Config_Read . . . . .         | 120 |
| Table 123. SFOUT_Config_Read Response . . . . .       | 120 |
| Table 124. 0x50 – MONMux_Config_Write . . . . .       | 121 |
| Table 125. MONMux_Config_Write Response . . . . .     | 121 |
| Table 126. 0x51 – MONMux_Config_Read . . . . .        | 121 |
| Table 127. MONMux_Config_Read Response . . . . .      | 122 |
| Table 128. 0x53 – ADC_Measure_Launch . . . . .        | 122 |
| Table 129. ADC_Measure_Launch Response . . . . .      | 122 |
| Table 130. 0x70 – BBst_Config_Write . . . . .         | 123 |
| Table 131. BBst_Config_Write Response . . . . .       | 124 |
| Table 132. 0x71 – BBst_Config_Read . . . . .          | 124 |
| Table 133. BBst_Config_Read Response . . . . .        | 124 |
| Table 134. 0xA0 – Hpt_Config_Write0 . . . . .         | 125 |
| Table 135. Hpt_Config_Write0 Response . . . . .       | 126 |
| Table 136. 0xA1 – Hpt_Config_Read0 . . . . .          | 126 |
| Table 137. Hpt_Config_Read0 Response . . . . .        | 127 |
| Table 138. 0xA2 – Hpt_Config_Write1 . . . . .         | 127 |
| Table 139. Hpt_Config_Write1 Response . . . . .       | 128 |
| Table 140. 0xA3 – Hpt_Config_Read1 . . . . .          | 128 |

**LIST OF TABLES (CONTINUED)**

|  |     |
|--|-----|
| Table 141. Hpt_Config_Read1 Response               | 128 |
| Table 142. 0xA4— Hpt_Config_Write2                 | 129 |
| Table 143. Hpt_Config_Write2 Response              | 130 |
| Table 144. 0xA5 – Hpt_Config_Read2                 | 130 |
| Table 145. Hpt_Config_Read2 Response               | 130 |
| Table 146. 0xA6 – Hpt_SYS_Threshold_Config_Write   | 130 |
| Table 147. Hpt_SYS_threshold_Config_Write Response | 130 |
| Table 148. 0xA7—Hpt_SYS_threshold_Config_Read      | 131 |
| Table 149. Hpt_SYS_threshold_Config_Read Response  | 131 |
| Table 150. 0xA8 – Hpt_Lock_Config_Write            | 131 |
| Table 151. Hpt_Lock_Config_Write Response          | 131 |
| Table 152. 0xA9 – Hpt_Lock_Config_Read             | 131 |
| Table 153. Hpt_Lock_Config_Read Response           | 131 |
| Table 154. 0xAA – Hpt_EMF_Threshold_Config_Write   | 132 |
| Table 155. Hpt_EMF_Threshold_Config_Write Response | 132 |
| Table 156. 0xAB – Hpt_EMF_Threshold_Config_Read    | 132 |
| Table 157. HPT_EMF_Threshold_Config_Read Response  | 132 |
| Table 158. 0xAC—HPT_Autotune                       | 132 |
| Table 159. HPT_Autotune Response                   | 133 |
| Table 160. 0xAD— HPT_SetMode                       | 133 |
| Table 161. HPT_SetMode Response                    | 133 |
| Table 162. 0xAE— HPT_SetInitialGuess               | 133 |
| Table 163. HPT_SetInitialGuess Response            | 133 |
| Table 164. 0xAF— HPT_SetInitialDelay               | 134 |
| Table 165. HPT_SetInitialDelay Response            | 134 |
| Table 166. 0xB0—HPT_SetWindow                      | 134 |
| Table 167. HPT_SetWindow Response                  | 134 |
| Table 168. 0xB1 – HPT_SetBackEMFCycle              | 134 |
| Table 169. HPT_SetBackEMFCycle Response            | 134 |
| Table 170. 0xB2—HPT_SetFullScale                   | 135 |
| Table 171. HPT_SetFullScale Response               | 135 |

**LIST OF TABLES (CONTINUED)**

|  |     |
|--|-----|
| Table 172. 0xB3—Hpt_SetHptPattern . . . . .                          | 135 |
| Table 173. Hpt_SetHptPattern Response . . . . .                      | 135 |
| Table 174. 0xB4—Hpt_SetGain . . . . .                                | 135 |
| Table 175. Hpt_SetGain Response . . . . .                            | 135 |
| Table 176. 0xB5—HPT_SetLock . . . . .                                | 136 |
| Table 177. Hpt_SetLock Response . . . . .                            | 136 |
| Table 178. 0xB6—Hpt_ReadResonanceFrequency . . . . .                 | 136 |
| Table 179. Hpt_ReadResonanceFrequency Response . . . . .             | 136 |
| Table 180. 0xB7—Hpt_SetTimeout . . . . .                             | 136 |
| Table 181. Hpt_SetTimeout Response . . . . .                         | 136 |
| Table 182. 0xB8—Hpt_GetTimeout . . . . .                             | 137 |
| Table 183. Hpt_GetTimeout Response . . . . .                         | 137 |
| Table 184. 0xB9—Hpt_SetBlankingWindow . . . . .                      | 137 |
| Table 185. Hpt_SetBlankingWindow Response . . . . .                  | 137 |
| Table 186. 0xBA—Hpt_SetZCC . . . . .                                 | 137 |
| Table 187. Hpt_SetZCC Response . . . . .                             | 137 |
| Table 188. 0x80—PowerOff_Command . . . . .                           | 138 |
| Table 189. PowerOff_Command Response . . . . .                       | 138 |
| Table 190. 0x81 – SoftReset_Command . . . . .                        | 138 |
| Table 191. SoftReset_Command Response . . . . .                      | 138 |
| Table 192. 0x82—Hard-Reset_Command . . . . .                         | 139 |
| Table 193. Hard-Reset_Command Response . . . . .                     | 139 |
| Table 194. 0x83—StayOn_Command . . . . .                             | 139 |
| Table 195. 0x83—StayOn_Command Response . . . . .                    | 140 |
| Table 196. 0x84—PowerOff_Command_Delay . . . . .                     | 140 |
| Table 197. PowerOff_Command_Delay Response . . . . .                 | 140 |
| Table 198. Register Summary . . . . .                                | 141 |
| Table 199. Haptic Driver Recommended Default Values . . . . .        | 145 |
| Table 200. Haptic Driver Recommended Default Values . . . . .        | 146 |
| Table 201. Register Bit Default Values . . . . .                     | 147 |
| Table 202. Register Bit Default Values . . . . .                     | 149 |
| Table 203. I <sup>2</sup> C Direct Register Default Values . . . . . | 149 |
| Table 204. Read Opcode Default Values . . . . .                      | 150 |

**Absolute Maximum Ratings**

BAT, SYS, MON, PFN1, PFN2, THM, INT, RST, SDA, SCL, CELL, ALRT, CTG, QSTRT, L2IN, BBOU .....-0.3V to +6V  
 VDIG, L1IN .....-0.3V to +2.2V  
 CHGIN .....-6V to +30V  
 CAP, SFOUT .....-0.3V to min(|CHGIN| + 0.3, +6)V  
 TPU .....-0.3V to VDIG + 0.3V  
 SET.....-0.3V to BAT + 0.3V  
 MPC0, MPC1, MPC2, MPC3, MPC4, DRP, DRN, BK1LX, BK2LX, BK1OUT, BK2OUT, CPP, BSTLVX, BBLVX.....-0.3V to SYS + 0.3V  
 L1OUT .....-0.3V to L1IN + 0.3V  
 L2OUT .....-0.3V to L2IN + 0.3V  
 CPP ..... CPN – 0.3V to CPN + 6V  
 CPOUT ..... CPP – 0.3V to min(CPP + 6, +12)V  
 BSTHVLX, BSTOUT, LED0, LED1, LED2.....-0.3V to +22V

BSTHVLX to BSTOUT .....-22V to +0.1V  
 BBHVLX .....-0.3V to min (BBOU + 0.3, +6)V  
 AGND, DGND, BK1GND, BK2GND, BSTGND, HDGND, BBGND to GSUB .....-0.3V to +0.3V  
 Continuous Current into BAT, SYS, CHGIN..... -1000mA to +1000mA  
 Continuous Current into DRP, DRN ..... -600mA to +600mA  
 Continuous Current into Any Other Terminal...-100mA to +100mA  
 Continuous Power Dissipation (multilayer board at +70°C): 7 x 8 Array 56-Ball, 3.71mm x 4.21mm, 0.5mm pitch WLP (derate 29.98mW/°C)....2399mW  
 Operating Temperature Range ..... -40°C to +85°C  
 Junction Temperature ..... +150°C  
 Storage Temperature Range ..... -65°C to +150°C  
 Lead Temperature (soldering, 10s) ..... +300°C  
 Soldering Temperature (reflow) ..... +260°C

*Stresses beyond those listed under "Absolute Maximum Ratings" may cause permanent damage to the device. These are stress ratings only, and functional operation of the device at these or any other conditions beyond those indicated in the operational sections of the specifications is not implied. Exposure to absolute maximum rating conditions for extended periods may affect device reliability.*

**Package Information**

|   |  |
|---|--|
| <b>PACKAGE TYPE: 56 WLP</b>                 |  |
| Package Code                                | W563A4+1                                       |
| Outline Number                              | <a href="#">21-100104</a>                      |
| Land Pattern Number                         | Refer to <a href="#">Application Note 1891</a> |
| <b>THERMAL RESISTANCE, FOUR-LAYER BOARD</b> |  |
| Junction to Ambient ( $\theta_{JA}$ )       | 33.35°C/W                                      |

For the latest package outline information and land patterns (footprints), go to [www.maximintegrated.com/packages](http://www.maximintegrated.com/packages). Note that a "+", "#", or "-" in the package code indicates RoHS status only. Package drawings may show a different suffix character, but the drawing pertains to the package regardless of RoHS status.

Package thermal resistances were obtained using the method described in JEDEC specification JESD51-7, using a four-layer board. For detailed information on package thermal considerations, refer to [www.maximintegrated.com/thermal-tutorial](http://www.maximintegrated.com/thermal-tutorial).

## Electrical Characteristics

( $V_{BAT} = +3.7V$ ,  $T_A = -20^{\circ}C$  to  $+70^{\circ}C$ , unless otherwise noted. Typical values are at  $T_A = +25^{\circ}C$ .  $C_{SFOUT} = 1\mu F$ ,  $C_{VDIG} = 1\mu F$ ,  $C_{CAP} = 1\mu F$ ,  $C_{SYS\_EFF} = 10\mu F$ ,  $C_{BK1OUT\_EFF} = 10\mu F$ ,  $C_{BK2OUT\_EFF} = 10\mu F$ ,  $C_{L1IN} = 1\mu F$ ,  $C_{L2IN} = 1\mu F$ ,  $C_{L1OUT} = 1\mu F$ ,  $C_{L2OUT} = 1\mu F$ ,  $C_{CPP} = 27nF$ ,  $C_{BSTOUT\_EFF} = 10\mu F$ ,  $C_{BBOUT\_EFF} = 10\mu F$ ,  $L_{BK1} = 2.2\mu H$ ,  $L_{BK2} = 2.2\mu H$ ,  $L_{BSTOUT} = 4.7\mu H$ ,  $L_{BBOUT} = 4.7\mu H$ ). (Note 1)

| PARAMETER                                 | SYMBOL                | CONDITIONS  | MIN  | TYP  | MAX  | UNITS   |
|---|-----------------------|---|------|------|------|---------|
| <b>GLOBAL SUPPLY CURRENT</b>              |                       |   |      |      |      |         |
| Charger Input Current                     | $I_{CHGIN}$           | $V_{CHGIN} = +5V$ , On state, charger disabled, Buck1 enabled, no LDO enabled |      | 1.1  |      | mA      |
| BAT Input Current                         | $I_{BAT}$             | $V_{CHGIN} = 0V$ , Off state, LDO2 disabled                                   |      | 0.4  |      | $\mu A$ |
|   |                       | $V_{CHGIN} = 0V$ , Off state, LDO2 enabled, L2IN connected to BAT             |      | 1.6  |      |         |
|   |                       | $V_{CHGIN} = 0V$ , On state, all blocks disabled, Fuel Gauge off              |      | 2.4  |      |         |
|   |                       | $V_{CHGIN} = 0V$ , On state, Buck1 enabled, Fuel Gauge off                    |      | 3.4  |      |         |
|   |                       | $V_{CHGIN} = 0V$ , On state, Buck1 and Buck2 enabled, Fuel Gauge off          |      | 3.9  |      |         |
| <b>INTERNAL SUPPLIES, BIAS, AND UVLOS</b> |                       |   |      |      |      |         |
| $V_{CCINTUVLO}$ Rising Threshold          | $V_{VCCINT\_UVLO\_R}$ | (Note 2)  | 2.25 | 2.45 | 2.75 | V       |
| $V_{CCINTUVLO}$ Falling Threshold         | $V_{VCCINT\_UVLO\_F}$ | (Note 2)  | 2.2  | 2.4  | 2.7  | V       |
| $V_{CCINTUVLO}$ Threshold Hysteresis      | $V_{VCCINT\_UVLO\_H}$ | (Note 2)  |      | 50   |      | mV      |
| Internal CAP Regulator                    | $V_{CAP}$             | $V_{CHGIN} = +4.3V$ to $+28V$   | 3.75 | 4.1  | 4.55 | V       |
| CAPOK Rising Threshold                    | $V_{CAP\_OK\_R}$      | $V_{CHGIN} = V_{CAP}$   | 3.15 | 3.4  | 3.6  | V       |
| CAPOK Falling Threshold                   | $V_{CAP\_OK\_F}$      | $V_{CHGIN} = V_{CAP}$   | 2.6  | 2.8  | 3    | V       |
| CAPOK Threshold Hysteresis                | $V_{CAP\_OK\_H}$      |   |      | 600  |      | mV      |
| $V_{BDET}$ Rising Threshold               | $V_{CHGIN\_DET\_R}$   |   | 4    | 4.15 | 4.3  | V       |
| $V_{BDET}$ Falling Threshold              | $V_{CHGIN\_DET\_F}$   |   | 3.2  | 3.3  | 3.4  | V       |
| $V_{BDET}$ Threshold Hysteresis           | $V_{CHGIN\_DET\_H}$   |   |      | 850  |      | mV      |
| CHGIN Detection Debounce Time             | $t_{CHGIN\_DET\_R}$   | CHGIN insertion   |      | 28   |      | ms      |
|   | $t_{CHGIN\_DET\_F}$   | CHGIN detachment  |      | 20   |      |         |
| $V_{SYSUVLO}$ Rising Threshold            | $V_{SYS\_UVLO\_R}$    |   | 2.65 | 2.75 | 2.85 | V       |
| $V_{SYSUVLO}$ Falling Threshold           | $V_{SYS\_UVLO\_F}$    |   | 2.6  | 2.7  | 2.8  | V       |
| $V_{SYSUVLO}$ Threshold Hysteresis        | $V_{SYS\_UVLO\_H}$    |   |      | 50   |      | mV      |

**Electrical Characteristics (continued)**

(V<sub>BAT</sub> = +3.7V, T<sub>A</sub> = -20°C to +70°C, unless otherwise noted. Typical values are at T<sub>A</sub> = +25°C. C<sub>SFOUT</sub> = 1μF, C<sub>VDIG</sub> = 1μF, C<sub>CAP</sub> = 1μF, C<sub>SYS\_EFF</sub> = 10μF, C<sub>BK1OUT\_EFF</sub> = 10μF, C<sub>BK2OUT\_EFF</sub> = 10μF, C<sub>L1IN</sub> = 1μF, C<sub>L2IN</sub> = 1μF, C<sub>L1OUT</sub> = 1μF, C<sub>L2OUT</sub> = 1μF, C<sub>CPP</sub> = 27nF, C<sub>BSTOUT\_EFF</sub> = 10μF, C<sub>BBOU\_T\_EFF</sub> = 10μF, L<sub>BK1</sub> = 2.2μH, L<sub>BK2</sub> = 2.2μH, L<sub>BSTOUT</sub> = 4.7μH, L<sub>BBOU\_T</sub> = 4.7μH). (Note 1)

| PARAMETER                                 | SYMBOL                      | CONDITIONS  | MIN  | TYP                     | MAX  | UNITS |
|---|-----------------------------|---|------|-------------------------|------|-------|
| BATOC Rising Threshold                    | I <sub>BAT_OC_R</sub>       | From 200mA to 1.6A in 200mA steps,<br>Device specific (See Table 201)         | -40  |                         | +40  | %     |
| BATOC Threshold Hysteresis                | I <sub>BAT_OC_H</sub>       |   |      | 6                       |      | %     |
| BATOC Rising Debounce Time                | t <sub>BAT_OC_D</sub>       |   | 9    | 10                      | 11   | ms    |
| Internal V <sub>DIG</sub> Regulator       | V <sub>VDIG</sub>           |   | 1.68 | 1.8                     | 2.0  | V     |
| V <sub>DIGUVLO</sub> Rising Threshold     | V <sub>VDIG_UVLO_R</sub>    |   | 1.61 |                         | 1.71 | V     |
| V <sub>DIGUVLO</sub> Falling Threshold    | V <sub>VDIG_UVLO_F</sub>    |   | 1.51 |                         | 1.61 | V     |
| V <sub>DIGUVLO</sub> Threshold Hysteresis | V <sub>VDIG_UVLO_H</sub>    |   |      | 100                     |      | mV    |
| <b>SFOUT</b>                              |                             |   |      |                         |      |       |
| SFOUT LDO Voltage                         | V <sub>SFOUT</sub>          | SFOUTVSet = 0 (+5V),<br>V <sub>CHGIN</sub> = +6V, I <sub>SFOUT</sub> = 0mA    | 4.85 | 5                       | 5.15 | V     |
|   |                             | SFOUTVSet = 0 (+5V),<br>V <sub>CHGIN</sub> = +5V, I <sub>SFOUT</sub> = 15mA   |      | 4.9                     |      |       |
|   |                             | SFOUTVSet = 1 (+3.3V),<br>V <sub>CHGIN</sub> = +5V, I <sub>SFOUT</sub> = 0mA  | 3.15 | 3.3                     | 3.45 |       |
|   |                             | SFOUTVSet = 1 (+3.3V),<br>V <sub>CHGIN</sub> = +5V, I <sub>SFOUT</sub> = 15mA |      | 3.29                    |      |       |
| SFOUT OVP Voltage                         | V <sub>SFOUT_OVP</sub>      | SFOUT LDO is turned off above<br>V <sub>CHGIN_OV_R</sub> threshold            |      | V <sub>CHGIN_OV_R</sub> |      | V     |
| SFOUT Thermal Limit                       | T <sub>SFOUT_LIM</sub>      |   |      | 150                     |      | °C    |
| <b>SAR ADC AND MON</b>                    |                             |   |      |                         |      |       |
| ADC Quiescent Current                     | I <sub>ADC_Q</sub>          | Conversion running  |      | 30                      |      | μA    |
| ADC SYS Divider Resistance                | R <sub>ADC_SYS_DIV</sub>    | SYS conversion running  |      | 2.2                     |      | MΩ    |
| ADC MON Divider Resistance                | R <sub>ADC_MON_DIV</sub>    | MON conversion running  |      | 2.2                     |      | MΩ    |
| ADC CHGIN Divider Resistance              | R <sub>ADC_CHGIN_DIV</sub>  | CHGIN conversion running  |      | 1.1                     |      | MΩ    |
| ADC CPOUT Divider Resistance              | R <sub>ADC_CPOUT_DIV</sub>  | CPOUT conversion running  |      | 0.82                    |      | MΩ    |
| ADC BSTOUT Divider Resistance             | R <sub>ADC_BSTOUT_DIV</sub> | BSTOUT conversion running   |      | 0.89                    |      | MΩ    |
| ADC SYS Least Significant Bit             | V <sub>ADC_SYS_LSB</sub>    |   |      | 21.57                   |      | mV    |

## Electrical Characteristics (continued)

( $V_{BAT} = +3.7V$ ,  $T_A = -20^{\circ}C$  to  $+70^{\circ}C$ , unless otherwise noted. Typical values are at  $T_A = +25^{\circ}C$ .  $C_{SFOUT} = 1\mu F$ ,  $C_{VDIG} = 1\mu F$ ,  $C_{CAP} = 1\mu F$ ,  $C_{SYS\_EFF} = 10\mu F$ ,  $C_{BK1OUT\_EFF} = 10\mu F$ ,  $C_{BK2OUT\_EFF} = 10\mu F$ ,  $C_{L1IN} = 1\mu F$ ,  $C_{L2IN} = 1\mu F$ ,  $C_{L1OUT} = 1\mu F$ ,  $C_{L2OUT} = 1\mu F$ ,  $C_{CPP} = 27nF$ ,  $C_{BSTOUT\_EFF} = 10\mu F$ ,  $C_{BBOUT\_EFF} = 10\mu F$ ,  $L_{BK1} = 2.2\mu H$ ,  $L_{BK2} = 2.2\mu H$ ,  $L_{BSTOUT} = 4.7\mu H$ ,  $L_{BBOUT} = 4.7\mu H$ ). (Note 1)

| PARAMETER                                       | SYMBOL                 | CONDITIONS   | MIN              | TYP   | MAX    | UNITS       |
|---|------------------------|--|------------------|-------|--------|-------------|
| ADC MON Least Significant Bit                   | $V_{ADC\_MON\_LSB}$    |  |                  | 21.57 |        | mV          |
| ADC THM Least Significant Bit                   | $V_{ADC\_THM\_LSB}$    |  |                  | 0.39  |        | % $V_{DIG}$ |
| ADC CHGIN Least Significant Bit                 | $V_{ADC\_CHGIN\_LSB}$  |  |                  | 32.35 |        | mV          |
| ADC CPOUT Least Significant Bit                 | $V_{ADC\_CPOUT\_LSB}$  |  |                  | 32.35 |        | mV          |
| ADC BSTOUT Least Significant Bit                | $V_{ADC\_BSTOUT\_LSB}$ |  |                  | 82.35 |        | mV          |
| ADC SYS Absolute Sensing Worst-Case Accuracy    | $V_{ADC\_SYS\_ACC}$    | $V_{SYS} = +2.6V$  | -55              |       | +55    | mV          |
|   |                        | $V_{SYS} = +5.5V$  | -96              |       | +96    |             |
| ADC MON Absolute Sensing Worst-Case Accuracy    | $V_{ADC\_MON\_ACC}$    | $V_{MON} = +1.0V$  | -35              |       | +35    | mV          |
|   |                        | $V_{MON} = +5.5V$  | -96              |       | +96    |             |
| ADC THM Percentage Sensing Worst-Case Accuracy  | $V_{ADC\_THM\_ACC}$    | $V_{THM} = (5 \text{ to } 95)\%V_{DIG}$  | -1.539           |       | +1.539 | % $V_{DIG}$ |
| ADC CHGIN Absolute Sensing Worst-Case Accuracy  | $V_{ADC\_CHGIN\_ACC}$  | $V_{CHGIN} = +3.0V$  | -70              |       | +70    | mV          |
|   |                        | $V_{CHGIN} = +8.0V$  | -139             |       | +139   |             |
| ADC CPOUT Absolute Sensing Worst-Case Accuracy  | $V_{ADC\_CPOUT\_ACC}$  | $V_{CPOUT} = +5.0V$  | -97              |       | +97    | mV          |
|   |                        | $V_{CPOUT} = +6.6V$  | -119             |       | +119   |             |
| ADC BSTOUT Absolute Sensing Worst-Case Accuracy | $V_{ADC\_BSTOUT\_ACC}$ | $V_{BSTOUT} = +3.0V$   | -122             |       | +122   | mV          |
|   |                        | $V_{BSTOUT} = +21.0V$  | -359             |       | +359   |             |
| ADC Conversion Time                             | $t_{ADC\_CONV}$        | 1.1ms (typ) additional delay prior to each 1 <sup>st</sup> conversion.           |                  | 83    |        | $\mu s$     |
| THM Input Leakage                               | $I_{LK\_THM}$          |  | -1               |       | +1     | $\mu A$     |
| TPU Switch Resistance                           | $R_{TPU\_SW}$          | 1mA max load on TPU  |                  | 4     |        | $\Omega$    |
| MON Multiplexer Output Ratio                    | $V_{MON\_DIV\_RT}$     | No load on MON pin. Inputs: BAT, SYS, BK1OUT, BK2OUT, L1OUT, L2OUT, SFOUT, BBOUT | MonRatioCfg = 00 |       | 100    | %           |
|   |                        |  | MonRatioCfg = 01 |       | 50     |             |
|   |                        |  | MonRatioCfg = 10 |       | 33.33  |             |
|   |                        |  | MonRatioCfg = 11 |       | 25     |             |

Electrical Characteristics (continued)

(V<sub>BAT</sub> = +3.7V, T<sub>A</sub> = -20°C to +70°C, unless otherwise noted. Typical values are at T<sub>A</sub> = +25°C. C<sub>SFOUT</sub> = 1µF, C<sub>VDIG</sub> = 1µF, C<sub>CAP</sub> = 1µF, C<sub>SYS\_EFF</sub> = 10µF, C<sub>BK1OUT\_EFF</sub> = 10µF, C<sub>BK2OUT\_EFF</sub> = 10µF, C<sub>L1IN</sub> = 1µF, C<sub>L2IN</sub> = 1µF, C<sub>L1OUT</sub> = 1µF, C<sub>L2OUT</sub> = 1µF, C<sub>CPP</sub> = 27nF, C<sub>BSTOUT\_EFF</sub> = 10µF, C<sub>BBOU\_T\_EFF</sub> = 10µF, L<sub>BK1</sub> = 2.2µH, L<sub>BK2</sub> = 2.2µH, L<sub>BSTOUT</sub> = 4.7µH, L<sub>BBOU\_T</sub> = 4.7µH). (Note 1)

| PARAMETER   | SYMBOL                        | CONDITIONS   | MIN              | TYP      | MAX | UNITS |
|---|-------------------------------|--|------------------|----------|-----|-------|
| MON Multiplexer Output Impedance                          | R <sub>MON_DIV</sub>          | 100µA load on MON pin. Inputs: BAT, SYS, BK2OUT, BK1OUT, L2OUT, L1OUT, SFOUT, BBOU_T | MonRatioCfg = 00 |          | 5.5 | kΩ    |
|   |                               | No load on MON pin. Inputs: BAT, SYS, BK2OUT, BK1OUT, L2OUT, L1OUT, SFOUT, BBOU_T    | MonRatioCfg = 01 |          | 31  |       |
|   |                               |  | MonRatioCfg = 10 |          | 28  |       |
|   |                               |  | MonRatioCfg = 11 |          | 24  |       |
| MON Multiplexer Off State Pulldown Resistance             | R <sub>MON_OFF_PD</sub>       | MON disabled, pulldown resistance enabled  |                  | 59       | kΩ  |       |
| <b>OVP AND INPUT CURRENT LIMITER</b>                      |                               |  |                  |          |     |       |
| Allowed CHGIN Input Voltage Range                         | V <sub>CHGIN_RNG</sub>        |  | -5.5             |          | +28 | V     |
| CHGIN Overvoltage Rising Threshold                        | V <sub>CHGIN_OV_R</sub>       | SFOU_T LDO is turned off above this threshold  | 7.2              | 7.5      | 7.8 | V     |
| CHGIN Overvoltage Threshold Hysteresis                    | V <sub>CHGIN_OV_H</sub>       |  |                  | 200      |     | mV    |
| CHGIN Valid Trip Point                                    | V <sub>CHGN-SYS_TP</sub>      | V <sub>CHGIN</sub> - V <sub>SYS</sub>  | 30               | 145      | 290 | mV    |
| CHGIN Valid Trip Point Hysteresis                         | V <sub>CHGIN-SYS_TP-HYS</sub> |  |                  | 275      |     | mV    |
| Input Overcurrent Max Limit (t < t <sub>LIM_BLANK</sub> ) | I <sub>LIM_MAX</sub>          | I <sub>LimMax</sub> = 0/1, device specific (see Table 201)                           |                  | 450/1000 |     | mA    |
| Input Current Limit (t > t <sub>LIM_BLANK</sub> )         | I <sub>LIM</sub>              | I <sub>LimCnt</sub> = 000  |                  | 50       |     | mA    |
|   |                               | I <sub>LimCnt</sub> = 001  |                  | 90       |     |       |
|   |                               | I <sub>LimCnt</sub> = 010  |                  | 150      |     |       |
|   |                               | I <sub>LimCnt</sub> = 011  |                  | 200      |     |       |
|   |                               | I <sub>LimCnt</sub> = 100  |                  | 300      |     |       |
|   |                               | I <sub>LimCnt</sub> = 101  |                  | 400      |     |       |
|   |                               | I <sub>LimCnt</sub> = 110  |                  | 450      |     |       |
|   |                               | I <sub>LimCnt</sub> = 111  |                  | 1000     |     |       |



**Electrical Characteristics (continued)**

(V<sub>BAT</sub> = +3.7V, T<sub>A</sub> = -20°C to +70°C, unless otherwise noted. Typical values are at T<sub>A</sub> = +25°C. C<sub>SFOUT</sub> = 1µF, C<sub>VDIG</sub> = 1µF, C<sub>CAP</sub> = 1µF, C<sub>SYN\_EFF</sub> = 10µF, C<sub>BK1OUT\_EFF</sub> = 10µF, C<sub>BK2OUT\_EFF</sub> = 10µF, C<sub>L1IN</sub> = 1µF, C<sub>L2IN</sub> = 1µF, C<sub>L1OUT</sub> = 1µF, C<sub>L2OUT</sub> = 1µF, C<sub>CPP</sub> = 27nF, C<sub>BSTOUT\_EFF</sub> = 10µF, C<sub>BBOU\_T\_EFF</sub> = 10µF, L<sub>BK1</sub> = 2.2µH, L<sub>BK2</sub> = 2.2µH, L<sub>BSTOUT</sub> = 4.7µH, L<sub>BBOU\_T</sub> = 4.7µH). (Note 1)

| PARAMETER                                  | SYMBOL                     | CONDITIONS   | MIN                         | TYP                         | MAX                         | UNITS |
|--|----------------------------|--|-----------------------------|-----------------------------|-----------------------------|-------|
| Input Current Limit Blanking Time          | t <sub>LIM_BLANK</sub>     | ILimBlank = 00   |                             | 0.003                       |                             | ms    |
|  |                            | ILimBlank = 01   |                             | 0.5                         |                             |       |
|  |                            | ILimBlank = 10   |                             | 1                           |                             |       |
|  |                            | ILimBlank = 11   |                             | 10                          |                             |       |
| SYS Regulation Voltage                     | V <sub>SYN_REG</sub>       |  | V <sub>BAT_REG</sub> + 0.14 | V <sub>BAT_REG</sub> + 0.2  | V <sub>BAT_REG</sub> + 0.26 | V     |
| SYS Regulation Voltage Dropout             | V <sub>CHGIN-SYS</sub>     |  |                             | 40                          |                             | mV    |
| CHGIN to SYS On-Resistance                 | R <sub>CHGIN-SYS</sub>     |  |                             | 0.37                        | 0.66                        | Ω     |
| Input Current Soft-Start Time              | I <sub>LIM_SFT</sub>       |  |                             | 1                           |                             | ms    |
| Thermal Shutdown Temperature               | T <sub>CHGIN_SHDN</sub>    | See T <sub>CHGIN_SHDN</sub> in table 201 for device specific threshold                     |                             | 50                          |                             | °C    |
|  |                            |  |                             | 60                          |                             |       |
|  |                            |  |                             | 70                          |                             |       |
|  |                            |  |                             | 80                          |                             |       |
|  |                            |  |                             | 90                          |                             |       |
|  |                            |  |                             | 100                         |                             |       |
|  |                            |  |                             | 110                         |                             |       |
|  |                            |  |                             | 120                         |                             |       |
| Thermal Shutdown Timeout                   | T <sub>CHGIN_SHDN_TO</sub> | TShdnTmo = 01  |                             | 0.5                         |                             | s     |
|  |                            | TShdnTmo = 10  |                             | 1                           |                             |       |
|  |                            | TShdnTmo = 11  |                             | 5                           |                             |       |
| <b>BATTERY CHARGER</b>                     |                            |  |                             |                             |                             |       |
| BAT to SYS On Resistance                   | R <sub>BAT-SYS</sub>       | V <sub>BAT</sub> = 4.2V, I <sub>BAT</sub> = 300mA  |                             | 80                          | 140                         | mΩ    |
| Thermal Regulation Temperature             | T <sub>CHG_LIM</sub>       |  |                             | T <sub>CHGIN_SHDN</sub> - 3 |                             | °C    |
| BAT-to-SYS Switch On Threshold             | V <sub>BAT-SYS_ON</sub>    | SYS falling  | 10                          | 22                          | 35                          | mV    |
| BAT-to-SYS Switch Off Threshold            | V <sub>BAT-SYS_OFF</sub>   | SYS rising   | -3                          | -1.5                        | 0                           | mV    |
| SYS-BAT Charge Current Reduction Threshold | V <sub>SYN-BAT_LIM</sub>   | Measured as V <sub>SYN</sub> - V <sub>BAT</sub> , SysMinVlt = 000, V <sub>BAT</sub> > 3.6V |                             | 100                         |                             | mV    |

Electrical Characteristics (continued)

(V<sub>BAT</sub> = +3.7V, T<sub>A</sub> = -20°C to +70°C, unless otherwise noted. Typical values are at T<sub>A</sub> = +25°C. C<sub>SFOUT</sub> = 1μF, C<sub>VDIG</sub> = 1μF, C<sub>CAP</sub> = 1μF, C<sub>SYS\_EFF</sub> = 10μF, C<sub>BK1OUT\_EFF</sub> = 10μF, C<sub>BK2OUT\_EFF</sub> = 10μF, C<sub>L1IN</sub> = 1μF, C<sub>L2IN</sub> = 1μF, C<sub>L1OUT</sub> = 1μF, C<sub>L2OUT</sub> = 1μF, C<sub>CPP</sub> = 27nF, C<sub>BSTOUT\_EFF</sub> = 10μF, C<sub>BBOU\_T\_EFF</sub> = 10μF, L<sub>BK1</sub> = 2.2μH, L<sub>BK2</sub> = 2.2μH, L<sub>BSTOUT</sub> = 4.7μH, L<sub>BBOU\_T</sub> = 4.7μH). (Note 1)

| PARAMETER                       | SYMBOL                    | CONDITIONS               | MIN             | TYP  | MAX | UNITS              |
|---------------------------------|---------------------------|--------------------------|-----------------|------|-----|--------------------|
| Minimum SYS Voltage             | V <sub>SYS_LIM</sub>      | V <sub>BAT</sub> < 3.4V  | SysMinVlt = 000 |      | 3.6 | V                  |
|                                 |                           |                          | SysMinVlt = 001 |      | 3.7 |                    |
|                                 |                           |                          | SysMinVlt = 010 |      | 3.8 |                    |
|                                 |                           |                          | SysMinVlt = 011 |      | 3.9 |                    |
|                                 |                           |                          | SysMinVlt = 100 |      | 4.0 |                    |
|                                 |                           |                          | SysMinVlt = 101 |      | 4.1 |                    |
|                                 |                           |                          | SysMinVlt = 110 |      | 4.2 |                    |
|                                 |                           |                          | SysMinVlt = 111 |      | 4.3 |                    |
| Charger Current Soft-Start Time | t <sub>CHG_SOFT</sub>     |                          |                 | 1    |     | ms                 |
| Precharge Current               | I <sub>PCHG</sub>         | IPChg = 00               |                 | 5    |     | %I <sub>FCHG</sub> |
|                                 |                           | IPChg = 01               | 9               | 10   | 11  |                    |
|                                 |                           | IPChg = 10               |                 | 20   |     |                    |
|                                 |                           | IPChg = 11               |                 | 30   |     |                    |
| Precharge Threshold             | V <sub>BAT_PCHG</sub>     | VPChg = 000              |                 | 2.1  |     | V                  |
|                                 |                           | VPChg = 001              |                 | 2.25 |     |                    |
|                                 |                           | VPChg = 010              |                 | 2.4  |     |                    |
|                                 |                           | VPChg = 011              |                 | 2.55 |     |                    |
|                                 |                           | VPChg = 100              |                 | 2.7  |     |                    |
|                                 |                           | VPChg = 101              |                 | 2.85 |     |                    |
|                                 |                           | VPChg = 110              |                 | 3    |     |                    |
|                                 |                           | VPChg = 111              |                 | 3.15 |     |                    |
| Precharge Threshold Hysteresis  | V <sub>BAT_PCHG_HYS</sub> |                          |                 | 90   |     | mV                 |
| SET Current Gain Factor         | K <sub>SET</sub>          |                          |                 | 2000 |     | A/A                |
| SET Regulation Voltage          | V <sub>SET</sub>          |                          |                 | 1    |     | V                  |
| BAT Charge Current Set Range    | I <sub>FCHG</sub>         | R <sub>SET</sub> = 400kΩ |                 | 5    |     | mA                 |
|                                 |                           | R <sub>SET</sub> = 40kΩ  | 45              | 50   | 55  |                    |
|                                 |                           | R <sub>SET</sub> = 4kΩ   |                 | 500  |     |                    |

**Electrical Characteristics (continued)**

( $V_{BAT} = +3.7V$ ,  $T_A = -20^{\circ}C$  to  $+70^{\circ}C$ , unless otherwise noted. Typical values are at  $T_A = +25^{\circ}C$ .  $C_{SFOUT} = 1\mu F$ ,  $C_{VDIG} = 1\mu F$ ,  $C_{CAP} = 1\mu F$ ,  $C_{SYS\_EFF} = 10\mu F$ ,  $C_{BK1OUT\_EFF} = 10\mu F$ ,  $C_{BK2OUT\_EFF} = 10\mu F$ ,  $C_{L1IN} = 1\mu F$ ,  $C_{L2IN} = 1\mu F$ ,  $C_{L1OUT} = 1\mu F$ ,  $C_{L2OUT} = 1\mu F$ ,  $C_{CPP} = 27nF$ ,  $C_{BSTOUT\_EFF} = 10\mu F$ ,  $C_{BBOU\_EFF} = 10\mu F$ ,  $L_{BK1} = 2.2\mu H$ ,  $L_{BK2} = 2.2\mu H$ ,  $L_{BSTOUT} = 4.7\mu H$ ,  $L_{BBOU} = 4.7\mu H$ ). (Note 1)

| PARAMETER   | SYMBOL           | CONDITIONS                         | MIN   | TYP  | MAX   | UNITS        |
|---|------------------|------------------------------------|-------|------|-------|--------------|
| Battery Regulation Voltage                                  | $V_{BAT\_REG}$   | BatReg = 0000                      |       | 4.05 |       | V            |
|   |                  | BatReg = 0001                      |       | 4.10 |       |              |
|   |                  | BatReg = 0010                      |       | 4.15 |       |              |
|   |                  | BatReg = 0011, $T_A = 25^{\circ}C$ | 4.179 | 4.20 | 4.221 |              |
|   |                  | BatReg = 0011                      | 4.158 | 4.20 | 4.242 |              |
|   |                  | BatReg = 0100                      |       | 4.25 |       |              |
|   |                  | BatReg = 0101                      |       | 4.30 |       |              |
|   |                  | BatReg = 0110                      |       | 4.35 |       |              |
|   |                  | BatReg = 0111                      |       | 4.40 |       |              |
|   |                  | BatReg = 1000                      |       | 4.45 |       |              |
|   |                  | BatReg = 1001                      |       | 4.50 |       |              |
|   |                  | BatReg = 1010                      |       | 4.55 |       |              |
| BatReg = 1011   |                  | 4.60                               |       |      |       |              |
| Battery Recharge Threshold                                  | $V_{BAT\_RECHG}$ | BatReChg = 00                      |       | 70   |       | mV           |
|   |                  | BatReChg = 01                      |       | 120  |       |              |
|   |                  | BatReChg = 10                      |       | 170  |       |              |
|   |                  | BatReChg = 11                      |       | 220  |       |              |
| Maximum Precharge Time                                      | $t_{PCHG}$       | PChgTmr = 00                       |       | 30   |       | min          |
|   |                  | PChgTmr = 01                       |       | 60   |       |              |
|   |                  | PChgTmr = 10                       |       | 120  |       |              |
|   |                  | PChgTmr = 11                       |       | 240  |       |              |
| Maximum Fast Charge Time                                    | $t_{FCHG}$       | FChgTmr = 00                       |       | 75   |       | min          |
|   |                  | FChgTmr = 01                       |       | 150  |       |              |
|   |                  | FChgTmr = 10                       |       | 300  |       |              |
|   |                  | FChgTmr = 11                       |       | 600  |       |              |
| Charge Done Qualification                                   | $I_{CHG\_DONE}$  | ChgDone = 00                       |       | 5    |       | % $I_{FCHG}$ |
|   |                  | ChgDone = 01                       | 8.5   | 10   | 11.5  |              |
|   |                  | ChgDone = 10                       |       | 20   |       |              |
|   |                  | ChgDone = 11                       |       | 30   |       |              |
| Timer Accuracy  | $t_{CHG\_ACC}$   |                                    | -10   |      | 10    | %            |
| Timer Extend Threshold (1/2 Fast Charge Current Comparator) | $t_{CHG\_EXT}$   | See Figure 5                       |       | 50   |       | % $I_{FCHG}$ |

**Electrical Characteristics (continued)**

( $V_{BAT} = +3.7V$ ,  $T_A = -20^{\circ}C$  to  $+70^{\circ}C$ , unless otherwise noted. Typical values are at  $T_A = +25^{\circ}C$ .  $C_{SFOUT} = 1\mu F$ ,  $C_{VDIG} = 1\mu F$ ,  $C_{CAP} = 1\mu F$ ,  $C_{SYS\_EFF} = 10\mu F$ ,  $C_{BK1OUT\_EFF} = 10\mu F$ ,  $C_{BK2OUT\_EFF} = 10\mu F$ ,  $C_{L1IN} = 1\mu F$ ,  $C_{L2IN} = 1\mu F$ ,  $C_{L1OUT} = 1\mu F$ ,  $C_{L2OUT} = 1\mu F$ ,  $C_{CPP} = 27nF$ ,  $C_{BSTOUT\_EFF} = 10\mu F$ ,  $C_{BBOUT\_EFF} = 10\mu F$ ,  $L_{BK1} = 2.2\mu H$ ,  $L_{BK2} = 2.2\mu H$ ,  $L_{BSTOUT} = 4.7\mu H$ ,  $L_{BBOUT} = 4.7\mu H$ ). (Note 1)

| PARAMETER  | SYMBOL               | CONDITIONS                              | MIN | TYP                      | MAX | UNITS        |
|--|----------------------|---|-----|--------------------------|-----|--------------|
| Timer Suspend Threshold (1/5 Fast Charge Current Comparator)         | $t_{CHG\_SUS}$       | See Figure 5                            |     | 20                       |     | % $I_{FCHG}$ |
| THM Percentage Sensing Worst Case Accuracy                           | $V_{ADC\_THM\_ACC}$  | $V_{THM} = (5 \text{ to } 95)\%V_{DIG}$ |     | see ADC section          |     |              |
| Cool/Cold Threshold Hysteresis                                       |                      | Falling, $LSB = 0.39\%V_{DIG}$          |     | 0 to 31                  |     | LSB          |
| Warm/Hot Threshold Hysteresis  |                      | Rising, $LSB = 0.39\%V_{DIG}$           |     | 0 to 31                  |     | LSB          |
| Battery Regulation Voltage Reduction Due to Battery Pack Temperature | $V_{BAT\_REG\_RED}$  | Cold/Cool/Room/Warm/<br>HotBatReg = 00  |     | BatReg<br>– 150mV        |     | V            |
|  |                      | Cold/Cool/Room/Warm/<br>HotBatReg = 01  |     | BatReg<br>– 100mV        |     |              |
|  |                      | Cold/Cool/Room/Warm/<br>HotBatReg = 10  |     | BatReg<br>– 50mV         |     |              |
|  |                      | Cold/Cool/Room/Warm/<br>HotBatReg = 11  |     | BatReg                   |     |              |
| Fast Charge Current Reduction Due to Battery Pack Temperature        | $I_{FCHG\_FACT}$     | Cold/Cool/Room/Warm/<br>HotFChg = 000   |     | $I_{FCHG} \times$<br>0.2 |     | mA           |
|  |                      | Cold/Cool/Room/Warm/<br>HotFChg = 001   |     | $I_{FCHG} \times$<br>0.3 |     |              |
|  |                      | Cold/Cool/Room/Warm/<br>HotFChg = 010   |     | $I_{FCHG} \times$<br>0.4 |     |              |
|  |                      | Cold/Cool/Room/Warm/<br>HotFChg = 011   |     | $I_{FCHG} \times$<br>0.5 |     |              |
|  |                      | Cold/Cool/Room/Warm/<br>HotFChg = 100   |     | $I_{FCHG} \times$<br>0.6 |     |              |
|  |                      | Cold/Cool/Room/Warm/<br>HotFChg = 101   |     | $I_{FCHG} \times$<br>0.7 |     |              |
|  |                      | Cold/Cool/Room/Warm/<br>HotFChg = 110   |     | $I_{FCHG} \times$<br>0.8 |     |              |
|  |                      | Cold/Cool/Room/Warm/<br>HotFChg = 111   |     | $I_{FCHG}$               |     |              |
| BAT UVLO Threshold   | $V_{BAT\_UVLO}$      |   | 1.9 | 2.05                     | 2.2 | V            |
| BAT UVLO Threshold Hysteresis  | $V_{BAT\_UVLO\_HYS}$ |   |     | 50                       |     | mV           |

**Electrical Characteristics (continued)**

( $V_{BAT} = +3.7V$ ,  $T_A = -20^{\circ}C$  to  $+70^{\circ}C$ , unless otherwise noted. Typical values are at  $T_A = +25^{\circ}C$ .  $C_{SFOUT} = 1\mu F$ ,  $C_{VDIG} = 1\mu F$ ,  $C_{CAP} = 1\mu F$ ,  $C_{SYS\_EFF} = 10\mu F$ ,  $C_{BK1OUT\_EFF} = 10\mu F$ ,  $C_{BK2OUT\_EFF} = 10\mu F$ ,  $C_{L1IN} = 1\mu F$ ,  $C_{L2IN} = 1\mu F$ ,  $C_{L1OUT} = 1\mu F$ ,  $C_{L2OUT} = 1\mu F$ ,  $C_{CPP} = 27nF$ ,  $C_{BSTOUT\_EFF} = 10\mu F$ ,  $C_{BBOU\_EFF} = 10\mu F$ ,  $L_{BK1} = 2.2\mu H$ ,  $L_{BK2} = 2.2\mu H$ ,  $L_{BSTOUT} = 4.7\mu H$ ,  $L_{BBOU} = 4.7\mu H$ ). (Note 1)

| PARAMETER   | SYMBOL               | CONDITIONS   | MIN  | TYP  | MAX   | UNITS      |
|---|----------------------|--|------|------|-------|------------|
| <b>BUCK1</b>  |                      |  |      |      |       |            |
| Input Voltage Range                                   | $V_{BK1IN}$          | Input voltage = $V_{SYS}$  | 2.7  |      | 5.5   | V          |
| Output Voltage Range                                  | $V_{BK1OUT}$         | 25mV step resolution   | 0.7  |      | 2.275 | V          |
| Output Voltage UVLO                                   | $V_{UVLO\_BK1}$      | Rising edge, typical hysteresis = 70mV   |      |      | 0.62  | V          |
| Quiescent Supply Current                              | $I_{Q\_BK1}$         | $I_{BK1OUT} = 0$ , $V_{SYS} = +3.7V$ ,<br>Buck1VSet = 0b010100 (+1.2V)   |      | 0.8  | 1.3   | $\mu A$    |
| Dropout Quiescent Supply Current                      | $I_{Q\_DO\_BK1}$     | $I_{BK1OUT} = 0$ , $V_{SYS} - V_{BK1OUT} \leq +0.1V$   |      | 250  |       | $\mu A$    |
| Shutdown Supply Current with Active Discharge Enabled | $I_{SD\_BK1}$        | Buck 1 disabled, Buck1ActDsc = 1   |      | 60   |       | $\mu A$    |
| Output Average Voltage Accuracy                       | ACC_BK1              | $I_{BK1OUT} = 10mA$  | -2.6 |      | +2.6  | %          |
| Peak-to-Peak Ripple                                   | $V_{RPP\_BK1}$       | Buck1ISet = 0100 (100mA),<br>$C_{BK1OUT\_EFF} = 2.2\mu F$ ,<br>$I_{BK1OUT} = 1mA$  |      | 10   |       | mV         |
| Peak Current Set Range                                | $I_{PSET\_BK1}$      | 25mA step resolution. The accuracy of codes below 50mA is limited by $t_{ON\_MIN\_BK1}$                                    | 0    |      | 375   | mA         |
| Load Regulation Error                                 | $V_{LOAD\_REG\_BK1}$ | Buck1ISet = 0110 (150mA),<br>Buck1IAdptEn = 1, $I_{BK1OUT} = 300mA$  |      | -3   |       | %          |
| Line Regulation Error                                 | $V_{LINE\_REG\_BK1}$ | $V_{BK1OUT} = +1.2V$ , $V_{SYS}$ from +2.7V to +5.5V   |      | 2    |       | mV         |
| Maximum Operative Output Current                      | $I_{BK1\_MAX\_1111}$ | $V_{SYS} = +3.7V$ , Buck1VSet = 010100 (+1.2V), Buck1ISet = 1111 (375mA),<br>Buck1IAdptEn = 1, load regulation error = -5% | 350  |      |       | mA         |
| BK1OUT Pulldown Current                               | $I_{PD\_BK1\_E}$     | Buck 1 Enabled   |      | 100  | 200   | nA         |
| BK1OUT Pulldown Resistance with Buck Disabled         | $I_{PD\_BK1\_D}$     | Buck 1 Disabled, $V_{SYS} = +3.6V$ ,<br>Buck1VSet = 000000 (+0.7V)   |      | 7    |       | M $\Omega$ |
| PMOS On-Resistance                                    | $R_{P\_ON\_BK1}$     | Buck1FETScale = 0  |      | 0.35 | 0.49  | $\Omega$   |
|   | $R_{P\_ON\_BK1\_FS}$ | Buck1FETScale = 1  |      | 0.7  | 0.98  |            |
| NMOS On-Resistance                                    | $R_{N\_ON\_BK1}$     | Buck1FETScale = 0  |      | 0.25 | 0.4   | $\Omega$   |
|   | $R_{N\_ON\_BK1\_FS}$ | Buck1FETScale = 1  |      | 0.5  | 0.7   |            |
| Freewheeling On-Resistance                            | $R_{ON\_BK1\_FRWHL}$ | $V_{SYS} = +3.7V$ ,<br>Buck1VSet = 010100 (+1.2V)  |      | 7    | 12    | $\Omega$   |

**Electrical Characteristics (continued)**

(V<sub>BAT</sub> = +3.7V, T<sub>A</sub> = -20°C to +70°C, unless otherwise noted. Typical values are at T<sub>A</sub> = +25°C. C<sub>SFOUT</sub> = 1μF, C<sub>VDIG</sub> = 1μF, C<sub>CAP</sub> = 1μF, C<sub>SYS\_EFF</sub> = 10μF, C<sub>BK1OUT\_EFF</sub> = 10μF, C<sub>BK2OUT\_EFF</sub> = 10μF, C<sub>L1IN</sub> = 1μF, C<sub>L2IN</sub> = 1μF, C<sub>L1OUT</sub> = 1μF, C<sub>L2OUT</sub> = 1μF, C<sub>CPP</sub> = 27nF, C<sub>BSTOUT\_EFF</sub> = 10μF, C<sub>BBOU\_T\_EFF</sub> = 10μF, L<sub>BK1</sub> = 2.2μH, L<sub>BK2</sub> = 2.2μH, L<sub>BSTOUT</sub> = 4.7μH, L<sub>BBOU\_T</sub> = 4.7μH). (Note 1)

| PARAMETER   | SYMBOL                  | CONDITIONS   | MIN  | TYP  | MAX  | UNITS |
|---|-------------------------|--|------|------|------|-------|
| Minimum t <sub>ON</sub>                               | t <sub>ON_MIN_BK1</sub> |  |      | 60   | 95   | ns    |
| Maximum Duty Cycle                                    | D_MAX_BK1               | Buck1IAdptEn = 1   |      | 95   |      | %     |
| Switching Frequency                                   | FREQ_BK1                | Load regulation error = -5%  |      | 3    |      | MHz   |
| Average Current During Short-Circuit to GND           | I <sub>SHRT_BK1</sub>   | Buck1ISet = 0110 (150mA), Buck1IAdptEn = 1, V <sub>BK1OUT</sub> = 0V   |      | 100  |      | mA    |
| BK1LX Leakage Current                                 | I <sub>LK_BK1LX</sub>   | Buck 1 disabled  |      |      | 1    | μA    |
| Active Discharge Current                              | I <sub>ACTD_BK1</sub>   | V <sub>BK1OUT</sub> = +1.2V  | 8    | 19   | 35   | mA    |
| Passive Discharge Resistance                          | R <sub>PSV_BK1</sub>    |  |      | 10   |      | kΩ    |
| Full Turn-On Time                                     | t <sub>ON_BK1</sub>     | Time from enable to full current capability  |      | 58   |      | ms    |
| Efficiency  | EFFIC_BK1               | Buck1VSet = 010100 (+1.2V), I <sub>BK1OUT</sub> = 10mA, Buck1ISet = 0111 (175mA), Inductor: Murata DFE201610E-2R2M |      | 88.5 |      | %     |
| BK1LX Rising/Falling Slew Rate                        | SLW_BK1                 | Buck1LowEMI = 0  |      | 2    |      | V/ns  |
|   | SLW_BK1_L               | Buck1LowEMI = 1  |      | 0.5  |      |       |
| Thermal Shutdown Threshold                            | T <sub>SHDN_BK1</sub>   |  |      | 140  |      | °C    |
| <b>BUCK2</b>  |                         |  |      |      |      |       |
| Input Voltage Range                                   | V <sub>BK2IN</sub>      | Input voltage = V <sub>SYS</sub>   | 2.7  |      | 5.5  | V     |
| Output Voltage Range                                  | V <sub>BK2OUT</sub>     | 50mV step resolution   | 0.7  |      | 3.85 | V     |
| Output Voltage UVLO                                   | V <sub>UVLO_BK2</sub>   | Rising edge, typical hysteresis = 70mV   |      |      | 0.62 | V     |
| Quiescent Supply Current                              | I <sub>Q_BK2</sub>      | I <sub>BK2OUT</sub> = 0mA, V <sub>SYS</sub> = +3.7V, Buck2VSet = 001010 (+1.2V)                                    |      | 0.9  | 1.4  | μA    |
| Dropout Quiescent Supply Current                      | I <sub>Q_DO_BK2</sub>   | I <sub>BK2OUT</sub> = 0mA, V <sub>SYS</sub> - V <sub>BK2OUT</sub> ≤ +0.1V  |      | 250  |      | μA    |
| Shutdown Supply Current with Active Discharge Enabled | I <sub>SD_BK2</sub>     | Buck 2 disabled, Buck2ActDsc = 1   |      | 60   |      | μA    |
| Output Average Voltage Accuracy                       | ACC_BK2                 | I <sub>BK2OUT</sub> = 10mA, Buck2VSet ≤ 110100 (+3.3V)   | -2.6 |      | +2.6 | %     |
| Peak-to-Peak Ripple                                   | V <sub>RPP_BK2</sub>    | Buck2ISet = 0100 (100mA), C <sub>BK2OUT_EFF</sub> = 2.2μF, I <sub>BK2OUT</sub> = 1mA                               |      | 10   |      | mV    |
| Peak Current Set Range                                | I <sub>PSET_BK2</sub>   | 25mA step resolution. The accuracy of codes below 50mA is limited by t <sub>ON_MIN_BK2</sub>                       | 0    |      | 375  | mA    |

## Electrical Characteristics (continued)

(V<sub>BAT</sub> = +3.7V, T<sub>A</sub> = -20°C to +70°C, unless otherwise noted. Typical values are at T<sub>A</sub> = +25°C. C<sub>SFOUT</sub> = 1μF, C<sub>VDIG</sub> = 1μF, C<sub>CAP</sub> = 1μF, C<sub>SYST</sub> = 10μF, C<sub>BK1OUT</sub> = 10μF, C<sub>BK2OUT</sub> = 10μF, C<sub>L1IN</sub> = 1μF, C<sub>L2IN</sub> = 1μF, C<sub>L1OUT</sub> = 1μF, C<sub>L2OUT</sub> = 1μF, C<sub>CPP</sub> = 27nF, C<sub>BSTOUT</sub> = 10μF, C<sub>BBOU</sub> = 10μF, L<sub>BK1</sub> = 2.2μH, L<sub>BK2</sub> = 2.2μH, L<sub>BSTOUT</sub> = 4.7μH, L<sub>BBOU</sub> = 4.7μH). (Note 1)

| PARAMETER   | SYMBOL                    | CONDITIONS  | MIN | TYP  | MAX  | UNITS |
|---|---------------------------|---|-----|------|------|-------|
| Load Regulation Error                               | V <sub>LOAD_REG_BK2</sub> | Buck2ISet = 0110 (150mA),<br>Buck2IAdptEn = 1, I <sub>BK2OUT</sub> = 300mA  |     | -3   |      | %     |
| Line Regulation Error                               | V <sub>LINE_REG_BK2</sub> | V <sub>BK2OUT</sub> = +1.2V, V <sub>SYS</sub> from +2.7V<br>to +5.5V  |     | 2    |      | mV    |
| Maximum Operative<br>Output Current                 | I <sub>BK2_MAX_1111</sub> | V <sub>SYS</sub> = +3.7V, Buck2VSet = 001010<br>(+1.2V) Buck2ISet = 1111 (375mA),<br>Buck2IAdptEn = 1, load regulation<br>error = -5% | 350 |      |      | mA    |
| BK2OUT Pulldown<br>Current                          | I <sub>PD_BK2_E</sub>     | Buck 2 enabled  |     | 200  | 400  | nA    |
| BK2OUT Pulldown<br>Resistance with Buck<br>Disabled | I <sub>PD_BK2_D</sub>     | Buck 2 disabled, V <sub>SYS</sub> = +3.6V,<br>Buck2VSet = 000000 (+0.7V)  |     | 3.5  |      | MΩ    |
| PMOS On-Resistance                                  | R <sub>P_ON_BK2</sub>     | Buck2FETScale = 0   |     | 0.35 | 0.49 | Ω     |
|   | R <sub>P_ON_BK2_FS</sub>  | Buck2FETScale = 1   |     | 0.7  | 0.98 |       |
| NMOS On-Resistance                                  | R <sub>N_ON_BK2</sub>     | Buck2FETScale = 0   |     | 0.25 | 0.4  | Ω     |
|   | R <sub>N_ON_BK2_FS</sub>  | Buck2FETScale = 1   |     | 0.5  | 0.7  |       |
| Freewheeling<br>On-Resistance                       | R <sub>ON_BK2_FRWHL</sub> | V <sub>SYS</sub> = +3.7V,<br>Buck2VSet = 001010 (+1.2V)   |     | 7    | 12   | Ω     |
| Minimum t <sub>ON</sub>                             | t <sub>ON_MIN_BK2</sub>   |   |     | 60   | 95   | ns    |
| Maximum Duty Cycle                                  | D_MAX_BK2                 | Buck2IAdptEn = 1  |     | 95   |      | %     |
| Switching Frequency                                 | FREQ_BK2                  | Load regulation error = -5%   |     | 3    |      | MHz   |
| Average Current During<br>Short-Circuit to GND      | I <sub>SHRT_BK2</sub>     | Buck2ISet = 0110 (150mA),<br>Buck2IAdptEn = 1, V <sub>BK2OUT</sub> = 0V   |     | 100  |      | mA    |
| BK2LX Leakage Current                               | I <sub>LK_BK2LX</sub>     | Buck 2 disabled   |     |      | 1    | μA    |
| Active Discharge Current                            | I <sub>ACTD_BK2</sub>     | V <sub>BK2OUT</sub> = +1.2V   | 8   | 19   | 35   | mA    |
| Passive Discharge<br>Resistance                     | R <sub>PSV_BK2</sub>      |   |     | 10   |      | kΩ    |
| Full Turn-On Time                                   | t <sub>ON_BUCK2</sub>     | Time from enable to full current capability   |     | 58   |      | ms    |
| Efficiency  | EFFIC_BK2                 | Buck2VSet = 001010 (+1.2V), I <sub>BK2OUT</sub><br>= 10mA, Buck2ISet = 0111 (175mA),<br>Inductor: Murata DFE201610E-2R2M              |     | 88.5 |      | %     |
| BK2LX Rising/Falling<br>Slew Rate                   | SLW_BK2                   | Buck2LowEMI = 0   |     | 2    |      | V/ns  |
|   | SLW_BK2_L                 | Buck2LowEMI = 1   |     | 0.5  |      |       |
| Thermal Shutdown<br>Threshold                       | T <sub>SHDN_BK2</sub>     |   |     | 140  |      | °C    |

## Electrical Characteristics (continued)

( $V_{BAT} = +3.7V$ ,  $T_A = -20^{\circ}C$  to  $+70^{\circ}C$ , unless otherwise noted. Typical values are at  $T_A = +25^{\circ}C$ .  $C_{SFOUT} = 1\mu F$ ,  $C_{VDIG} = 1\mu F$ ,  $C_{CAP} = 1\mu F$ ,  $C_{SYS\_EFF} = 10\mu F$ ,  $C_{BK1OUT\_EFF} = 10\mu F$ ,  $C_{BK2OUT\_EFF} = 10\mu F$ ,  $C_{L1IN} = 1\mu F$ ,  $C_{L2IN} = 1\mu F$ ,  $C_{L1OUT} = 1\mu F$ ,  $C_{L2OUT} = 1\mu F$ ,  $C_{CPP} = 27nF$ ,  $C_{BSTOUT\_EFF} = 10\mu F$ ,  $C_{BBOUT\_EFF} = 10\mu F$ ,  $L_{BK1} = 2.2\mu H$ ,  $L_{BK2} = 2.2\mu H$ ,  $L_{BSTOUT} = 4.7\mu H$ ,  $L_{BBOUT} = 4.7\mu H$ ). (Note 1)

| PARAMETER                             | SYMBOL               | CONDITIONS  | MIN  | TYP  | MAX  | UNITS     |
|---------------------------------------|----------------------|---|------|------|------|-----------|
| <b>HVBOOST</b>                        |                      |   |      |      |      |           |
| Input Voltage Range                   | $V_{BSTIN}$          | Input voltage = $V_{SYS}$   | 2.7  |      | 5.5  | V         |
| Output Voltage Range                  | $V_{BSTOUT}$         | 250mV step resolution   | 5    |      | 20   | V         |
| Output Voltage UVLO                   | $V_{BSTOUT\_UVLO}$   | $V_{BSTOUT} - V_{SYS}$  | -2.7 | -2.2 | -1.6 | V         |
| Quiescent Supply Current              | $I_{Q\_BST}$         | $I_{BSTOUT} = 0mA$ , $V_{SYS} = +3.7V$ ,<br>$BstVSet = 000000 (+5V)$ , $T_A = 25^{\circ}C$  |      | 2.4  | 9    | $\mu A$   |
|                                       |                      | $I_{BSTOUT} = 0mA$ , $V_{SYS} = +3.7V$ ,<br>$BstVSet = 000000 (+5V)$  |      |      | 106  |           |
| Output Average Voltage Accuracy       | $ACC\_BST$           | $I_{BSTOUT} = 1mA$  | -2   |      | +2   | %         |
| Peak-to-Peak Ripple                   | $V_{RPP\_BST}$       | $BstISet = 1010 (350mA)$ ,<br>$BstVSet = 011100 (+12V)$ ,<br>$C_{BSTOUT\_EFF} = 10\mu F$ , $L = 4.7\mu H$ ,<br>$I_{BSTOUT} = 1mA$ |      | 5    |      | mV        |
| Peak Current Set Range                | $I_{PSET\_BST}$      | 25mA step resolution  | 100  |      | 475  | mA        |
| DC Load Regulation Error              | $V_{LOAD\_REG\_BST}$ | $BstVSet = 011100 (+12V)$ , $I_{BSTOUT} = 25mA$ ,<br>$BstISet = 1000 (300mA)$ ,<br>$BstIAdptEn = 1$                               |      | 0.3  |      | %         |
| DC Line Regulation Error              | $V_{LINE\_REG\_BST}$ | $BstVSet = 000110 (+6.5V)$ , $V_{SYS}$ from<br>$+2.7V$ to $+5.5V$   |      | 4    |      | mV        |
| Maximum Operative Output Power        | $P_{MAX\_BST}$       | $BstISet = 1000 (300mA)$ ,<br>$BstIAdptEn = 1$  | 300  | 700  |      | mW        |
| BSTOUT Pulldown Resistance            | $R_{BSTOUT}$         | -3% Load Reg Error  |      | 10   |      | $M\Omega$ |
| True Shutdown PMOS On-Resistance      | $R_{ON\_TS}$         | $I_{BSTOUT} = 100mA$  |      | 0.15 | 0.22 | $\Omega$  |
| Boost Freewheeling NMOS On-Resistance | $R_{N\_ONFRW\_N}$    | $I_{BSTOUT} = 100mA$  |      | 0.45 | 0.7  | $\Omega$  |
| Boost NMOS On-Resistance              | $R_{ONBST\_N}$       | $BstFETScale = 0$ , $I_{BSTOUT} = 100mA$  |      | 0.55 | 0.9  | $\Omega$  |
|                                       | $R_{ONBST\_NFS}$     | $BstFETScale = 1$ , $I_{BSTOUT} = 100mA$  |      | 1.1  | 1.8  |           |
| Schottky Diode Forward Voltage        | $V_{BE\_SCHOTTKY}$   | $I_{BSTOUT} = 100mA$ , $V_{BSTHV LX} - V_{BSTOUT}$  | 0.2  | 0.4  | 0.6  | V         |
| Freewheeling On-Resistance            | $R_{ONBST\_FRWHL}$   | $I_{BSTOUT} = 100mA$  |      | 50   | 80   | $\Omega$  |
| Minimum $t_{ON}$                      | $t_{ON\_BST\_MIN}$   |   |      | 65   |      | ns        |



**Electrical Characteristics (continued)**

( $V_{BAT} = +3.7V$ ,  $T_A = -20^{\circ}C$  to  $+70^{\circ}C$ , unless otherwise noted. Typical values are at  $T_A = +25^{\circ}C$ .  $C_{SFOUT} = 1\mu F$ ,  $C_{VDIG} = 1\mu F$ ,  $C_{CAP} = 1\mu F$ ,  $C_{SYS\_EFF} = 10\mu F$ ,  $C_{BK1OUT\_EFF} = 10\mu F$ ,  $C_{BK2OUT\_EFF} = 10\mu F$ ,  $C_{L1IN} = 1\mu F$ ,  $C_{L2IN} = 1\mu F$ ,  $C_{L1OUT} = 1\mu F$ ,  $C_{L2OUT} = 1\mu F$ ,  $C_{CPP} = 27nF$ ,  $C_{BSTOUT\_EFF} = 10\mu F$ ,  $C_{BBOUT\_EFF} = 10\mu F$ ,  $L_{BK1} = 2.2\mu H$ ,  $L_{BK2} = 2.2\mu H$ ,  $L_{BSTOUT} = 4.7\mu H$ ,  $L_{BBOUT} = 4.7\mu H$ ). (Note 1)

| PARAMETER   | SYMBOL                 | CONDITIONS  | MIN | TYP  | MAX | UNITS       |
|---|------------------------|---|-----|------|-----|-------------|
| Max Switching Frequency   | FREQ_BST_MX            | $V_{BSTOUT}$ regulation error = -150mV.<br>BstISet = 100mA, BstAdptEn = 0.                                  | 1.7 | 3.5  | 5.5 | MHz         |
| Max Peak Current Setting Extra Budget with BstAdptEn = 1        | $\Delta I_{P\_MAX}$    | BstAdptEn = 1, $V_{BSTOUT}$ regulation error = -200mV   | 150 | 250  | 450 | mA          |
| Short-Circuit Current Limit Difference vs. Peak Current Setting | $\Delta I_{BST\_SHRT}$ | BstAdptEn = 0   | 130 | 200  | 250 | mA          |
| BSTHVLX Leakage Current   | $I_{LK\_BSTHVLX}$      | Boost disabled  |     |      | 1   | $\mu A$     |
| BSTLVLX Leakage Current   | $I_{LK\_BSTLVLX}$      | Boost disabled  |     |      | 1   | $\mu A$     |
| Passive Discharge Resistance                                    | $R_{BSTPSV}$           |   |     | 10   |     | k $\Omega$  |
| Linear BSTOUT Precharge Current                                 | $I_{L\_BSTOUT\_PRCH}$  | $V_{BSTOUT}$ from 0 to $V_{SYS} - 0.4V$   | 5   | 12.5 | 20  | mA          |
| Switching Precharge Inductor Current                            | $I_{SW\_BSTOUT\_PRCH}$ | $V_{BSTOUT}$ from $V_{SYS} - 0.4V$ to final regulation voltage  |     | 13   |     | mA          |
| Full Turn-On Time   | $t_{ON\_BST}$          | Time from enable to full current capability   |     | 100  |     | ms          |
| Efficiency  | EFFIC_12               | BstVSet = 011100 (+12V), $I_{BSTOUT} = 20mA$ , BstISet = 1000 (300mA), Inductor: Murata DFE201610E-4R7M     |     | 85   |     | %           |
|   | EFFIC_15               | BstVSet = 101000 (+15V), $I_{BSTOUT} = 2mA$ , BstISet = 1000 (300mA), Inductor: Murata DFE201610E-4R7M      |     | 83   |     |             |
|   | EFFIC_5                | BstVSet = 000000 (+5V), $I_{BSTOUT} = 10\mu A$ , BstISet = 0010 (150mA), Inductor: Murata DFE201610E-4R7M   |     | 76   |     |             |
|   | EFFIC_6P5              | BstVSet = 000110 (+6.5V), $I_{BSTOUT} = 10\mu A$ , BstISet = 0010 (150mA), Inductor: Murata DFE201610E-4R7M |     | 73   |     |             |
| BHVLX Rising/Falling Slew Rate                                  | SLW_BST_HVLX           |   |     | 2    |     | V/ns        |
| Thermal Shutdown Threshold                                      | $T_{SHDN\_BST}$        |   |     | 125  |     | $^{\circ}C$ |

**Electrical Characteristics (continued)**

( $V_{BAT} = +3.7V$ ,  $T_A = -20^{\circ}C$  to  $+70^{\circ}C$ , unless otherwise noted. Typical values are at  $T_A = +25^{\circ}C$ .  $C_{SFOUT} = 1\mu F$ ,  $C_{VDIG} = 1\mu F$ ,  $C_{CAP} = 1\mu F$ ,  $C_{SYS\_EFF} = 10\mu F$ ,  $C_{BK1OUT\_EFF} = 10\mu F$ ,  $C_{BK2OUT\_EFF} = 10\mu F$ ,  $C_{L1IN} = 1\mu F$ ,  $C_{L2IN} = 1\mu F$ ,  $C_{L1OUT} = 1\mu F$ ,  $C_{L2OUT} = 1\mu F$ ,  $C_{CPP} = 27nF$ ,  $C_{BSTOUT\_EFF} = 10\mu F$ ,  $C_{BBOU\_EFF} = 10\mu F$ ,  $L_{BK1} = 2.2\mu H$ ,  $L_{BK2} = 2.2\mu H$ ,  $L_{BSTOUT} = 4.7\mu H$ ,  $L_{BBOU} = 4.7\mu H$ ). (Note 1)

| PARAMETER                             | SYMBOL               | CONDITIONS   | MIN | TYP  | MAX  | UNITS      |
|---------------------------------------|----------------------|--|-----|------|------|------------|
| <b>BUCK-BOOST</b>                     |                      |  |     |      |      |            |
| Input Voltage Range                   | $V_{BBIN}$           | Input voltage = $V_{SYS}$  | 2.7 |      | 5.5  | V          |
| Quiescent Supply Current              | $I_{Q\_BB}$          | $I_{BBOU} = 0\mu A$ , $V_{BBOU} = +4V$   |     | 1.3  | 2.1  | $\mu A$    |
| Maximum Output Operative Power        | $P_{MAX\_BBOU}$      | $V_{SYS} > +3V$  | 250 |      |      | mW         |
| Output Voltage Set Range              | $V_{BBOU}$           | 100mV step   | 2.5 |      | 5    | V          |
| Average Output Voltage Accuracy       | $ACC\_BBOU$          | $I_{BBOU} = 1mA$ , $C_{BBOU\_EFF} \geq 10\mu F$  | -3  |      | 3    | %          |
| Line Regulation Error                 | $V_{LINE\_REG\_BB}$  | $V_{SYS} = +2.7V$ to $+5.5V$ , $I_{BBOU} = 10\mu A$ , $BBstVSet = 001111$ (+4V), $BBstISet = 0010$ (100mA) | -1  | +0.3 | +1   | %/V        |
| Load Regulation Error                 | $V_{LOAD\_REG\_BB}$  | $BBstVSet = 001111$ (+4V), $I_{BBOU} = 10\mu A$ to 50mA, $BBstISet = 0010$ (100mA)                         |     | 100  |      | mV/A       |
|                                       |                      | $BBstVSet = 001111$ (+4V), $I_{BBOU} = 10\mu A$ to 100mA, $BBstISet = 0010$ (100mA)                        |     | 310  |      |            |
| Line Transient                        | $V_{LINE\_TRAN\_BB}$ | $BBstVSet = 001111$ (+4V), $BBstISet = 0010$ (100mA), $V_{SYS}$ from +2.7V to +5V, 0.2 $\mu s$ rise time   |     | 15   |      | mV         |
| Load Transient                        | $V_{LOAD\_TRAN\_BB}$ | $I_{BBOU} = 0mA$ to 10mA, 200ns rise time, $BBstVSet = 001111$ (+4V), $BBstISet = 0010$ (100mA)            |     | 9    |      | mV         |
|                                       |                      | $I_{BBOU} = 0mA$ to 100mA, 200ns rise time, $V_{BBOU} = 001111$ (+4V), $BBstISet = 0010$ (100mA)           |     | 31   |      |            |
| Oscillator Frequency                  | $f_{OSC\_BB}$        |  | 1.8 | 2    | 2.2  | MHz        |
| Output FETs $R_{ON}$                  | $R_{ON\_PBK\_BB}$    | High-side PMOS Buck FET  |     | 0.15 | 0.22 | $\Omega$   |
|                                       | $R_{ON\_NBK\_BB}$    | Low-side NMOS Buck FET   |     | 0.22 | 0.36 |            |
|                                       | $R_{ON\_PBST\_BB}$   | High-side PMOS Boost FET ( $V_{BBOU} = +4V$ )  |     | 0.21 | 0.31 |            |
|                                       | $R_{ON\_NBST\_BB}$   | Low-side NMOS Boost FET  |     | 0.24 | 0.4  |            |
|                                       | $R_{ON\_FRWH\_BB}$   | EMI improve FET between $BBHVLX/$ $BBLVLX$   |     | 8    | 11   |            |
| Passive Discharge Pulldown Resistance | $R_{PDL\_BB}$        | $BBstPasDsc = 1$   |     | 10   |      | k $\Omega$ |
| Active Discharge Current              | $I_{ACTDL\_BB}$      | $BBstActDsc = 1$ , $V_{BBOU} = +1.5V$  | 6   | 19   | 38   | mA         |

## Electrical Characteristics (continued)

( $V_{BAT} = +3.7V$ ,  $T_A = -20^{\circ}C$  to  $+70^{\circ}C$ , unless otherwise noted. Typical values are at  $T_A = +25^{\circ}C$ .  $C_{SFOUT} = 1\mu F$ ,  $C_{VDIG} = 1\mu F$ ,  $C_{CAP} = 1\mu F$ ,  $C_{SYS\_EFF} = 10\mu F$ ,  $C_{BK1OUT\_EFF} = 10\mu F$ ,  $C_{BK2OUT\_EFF} = 10\mu F$ ,  $C_{L1IN} = 1\mu F$ ,  $C_{L2IN} = 1\mu F$ ,  $C_{L1OUT} = 1\mu F$ ,  $C_{L2OUT} = 1\mu F$ ,  $C_{CPP} = 27nF$ ,  $C_{BSTOUT\_EFF} = 10\mu F$ ,  $C_{BBOU\_EFF} = 10\mu F$ ,  $L_{BK1} = 2.2\mu H$ ,  $L_{BK2} = 2.2\mu H$ ,  $L_{BSTOUT} = 4.7\mu H$ ,  $L_{BBOU} = 4.7\mu H$ ). (Note 1)

| PARAMETER   | SYMBOL               | CONDITIONS   | MIN  | TYP      | MAX   | UNITS       |
|---|----------------------|--|------|----------|-------|-------------|
| Turn-On Time  | $t_{ON\_BB}$         | Time from enable to full current capability  |      | 100      |       | ms          |
| UVLO On BBOU  | $V_{BBOU\_UVLO}$     |  | 1.65 | 1.75     | 1.9   | V           |
| Precharge Current   | $I_{PC\_BB}$         | Precharge current. $V_{SYS} = +2.7V$ , $V_{BBOU} = +1.65V$   | 6    | 14       | 24    | mA          |
| Pulse Mode Input Current Limit  | $I_{PLS\_IN}$        | $BBstVSet = 001111 (+4V)$ , $V_{SYS} < V_{BBOU} - 0.5V$ , $f_{SW} = f_{OSC\_BBST}/10$ , $BBstSet = 0010 (100mA)$ |      | 6.6      |       | mA          |
| Pulse Mode Switching Period Ratio   | $T\_RATIO$           | $f_{OSC\_BB}/f_{SW}$ 128 steps   | 10   |          | 138   |             |
| Average Current During Short-Circuit to GND   | $I_{SHRT\_BB}$       | $V_{BBOU} = 0V$  | 0.4  | 0.75     | 1.1   | A           |
| Thermal Shutdown Threshold  | $T_{SHDN\_BB}$       | $T_J$ rising   |      | 150      |       | $^{\circ}C$ |
| Thermal Shutdown Hysteresis   | $T_{SHDN\_HYST\_BB}$ |  |      | 10       |       | $^{\circ}C$ |
| <b>LDO1 (Typical values are at <math>V_{L1IN} = +1.2V</math>, <math>V_{L1OUT} = +1V</math>)</b> |                      |  |      |          |       |             |
| Input Voltage Range   | $V_{L1IN}$           | LDO mode   | 1    |          | 2     | V           |
|   |                      | Switch mode  | 0.7  |          | 2     |             |
| Quiescent Supply Current  | $I_{Q\_L1}$          | $I_{L1OUT} = 0\mu A$   |      | 1        | 2.1   | $\mu A$     |
|   |                      | $I_{L1OUT} = 0\mu A$ , Switch mode   |      | 0.35     | 0.7   |             |
|   |                      | LDO enabled, $I_{L1OUT} = 0\mu A$ , $LDO1\_MPC2CNT = 1$ , MPC2 high  |      | 0.7      | 1.35  |             |
| Output Leakage  | $I_{LK\_L1OUT}$      | $V_{L1OUT} = GND$ , LDO 1 disabled   |      | 0.015    | 2.5   | $\mu A$     |
| Quiescent Supply Current in Dropout   | $I_{Q\_L1\_DRP}$     | $I_{L1OUT} = 0\mu A$ , $V_{L1IN} = +1.2V$ , $LDO1VSet = 0x1D (+1.225V)$  |      | 2.4      | 4.2   | $\mu A$     |
| Maximum Output Current  | $I_{L1OUT\_MAX}$     |  | 50   |          |       | mA          |
| Output Voltage  | $V_{L1OUT}$          | 25mV step resolution   | 0.5  |          | 1.95  | V           |
| Output Accuracy   | $ACC\_LDO1$          | $(V_{L1OUT} + 0.2V) \leq V_{L1IN} \leq +2V$ , $I_{L1OUT} = 1mA$  | -3.4 |          | +3.9  | %           |
| Dropout Voltage   | $V_{DRP\_L1}$        | $V_{L1IN} = +1V$ , $LDO1VSet = 0x14 (+1V)$ , $I_{L1OUT} = 50mA$  |      |          | 63    | mV          |
| Line Regulation Error   | $V_{LINE\_REG\_L1}$  | $V_{L1IN} = (V_{L1OUT} + 0.2V)$ to $+2V$   | -0.5 |          | +0.5  | %/V         |
| Load Regulation Error   | $V_{LOAD\_REG\_L1}$  | $+1V \leq V_{L1IN} \leq +2V$ , $I_{L1OUT} = 100\mu A$ to $50mA$  |      | 0.003    | 0.013 | %/mA        |
| Line Transient  | $V_{LINE\_TRAN\_L1}$ | $V_{L1IN} = +1V$ to $+2V$ , 200ns rise time  |      | $\pm 45$ |       | mV          |
|   |                      | $V_{L1IN} = +1V$ to $+2V$ , 1 $\mu s$ rise time  |      | $\pm 25$ |       |             |
| Load Transient  | $V_{LOAD\_TRAN\_L1}$ | $I_{L1OUT} = 0$ to $10mA$ , 200ns rise time  |      | 80       |       | mV          |
|   |                      | $I_{L1OUT} = 0$ to $50mA$ , 200ns rise time  |      | 130      |       |             |

## Electrical Characteristics (continued)

(V<sub>BAT</sub> = +3.7V, T<sub>A</sub> = -20°C to +70°C, unless otherwise noted. Typical values are at T<sub>A</sub> = +25°C. C<sub>SFOUT</sub> = 1μF, C<sub>VDIG</sub> = 1μF, C<sub>CAP</sub> = 1μF, C<sub>SYST</sub> = 10μF, C<sub>BK1OUT</sub> = 10μF, C<sub>BK2OUT</sub> = 10μF, C<sub>L1IN</sub> = 1μF, C<sub>L2IN</sub> = 1μF, C<sub>L1OUT</sub> = 1μF, C<sub>L2OUT</sub> = 1μF, C<sub>CPP</sub> = 27nF, C<sub>BSTOUT</sub> = 10μF, C<sub>BBOU</sub> = 10μF, L<sub>BK1</sub> = 2.2μH, L<sub>BK2</sub> = 2.2μH, L<sub>BSTOUT</sub> = 4.7μH, L<sub>BBOU</sub> = 4.7μH). (Note 1)

| PARAMETER   | SYMBOL                   | CONDITIONS  |   | MIN  | TYP   | MAX  | UNITS             |
|---|--------------------------|---|---|------|-------|------|-------------------|
| Passive Discharge Resistance  | R <sub>PDL_L1</sub>      |   |   | 5    | 10    | 15   | kΩ                |
| Active Discharge Current  | I <sub>ACTDL_L1</sub>    |   |   | 7    | 25    | 55   | mA                |
| Switch Mode On-Resistance   | R <sub>ON_L1</sub>       | Switch mode   | V <sub>L1IN</sub> = +1V, I <sub>L1OUT</sub> = 50mA  |      |       | 1.02 | Ω                 |
|   |                          |   | V <sub>L1IN</sub> = +0.7V, I <sub>L1OUT</sub> = 1mA |      |       | 2.7  |                   |
| Turn-On Time  | t <sub>ON_L1</sub>       | I <sub>L1OUT</sub> = 0mA, time from 10% to 90% of LDO1VSet                        |   |      | 0.38  |      | ms                |
|   |                          | I <sub>L1OUT</sub> = 0mA, time from 10% to 90% of V <sub>L1IN</sub> , Switch mode |   |      | 0.065 |      |                   |
| Short Circuit Current Limit   | I <sub>SHRT_L1</sub>     | V <sub>L1IN</sub> = +1.2V, V <sub>L1OUT</sub> = 0V                                |   | 165  | 310   | 405  | mA                |
|   |                          | V <sub>L1IN</sub> = +1.2V, V <sub>L1OUT</sub> = 0V, Switch mode                   |   | 160  | 305   | 400  |                   |
| Thermal Shutdown Temperature  | T <sub>SHDN_L1</sub>     | T <sub>J</sub> rising   |   |      | 150   |      | °C                |
| Thermal Shutdown Temperature Hysteresis   | T <sub>SHDN_HYS_L1</sub> |   |   |      | 20    |      | °C                |
| Output Noise  |                          | 10Hz to 100kHz, V <sub>L1IN</sub> = +2V   | V <sub>L1OUT</sub> = +1.8V                          |      | 120   |      | μV <sub>RMS</sub> |
|   |                          |   | V <sub>L1OUT</sub> = +1V                            |      | 95    |      |                   |
|   |                          |   | V <sub>L1OUT</sub> = +0.5V                          |      | 70    |      |                   |
| UVLO  | V <sub>L1IN_UVLO_F</sub> | V <sub>L1IN</sub> falling   |   | 0.53 | 0.77  |      | V                 |
|   | V <sub>L1IN_UVLO_R</sub> | V <sub>L1IN</sub> rising  |   |      | 0.78  | 1    |                   |
| <b>LDO2 (Typical values at V<sub>L2IN</sub> = +3.7V, V<sub>L2OUT</sub> = +3V)</b> |                          |   |   |      |       |      |                   |
| Input Voltage Range   | V <sub>L2IN</sub>        | LDO mode  |   | 1.71 |       | 5.5  | V                 |
|   |                          | Switch mode   |   | 1.2  |       | 5.5  |                   |
| Quiescent Supply Current  | I <sub>Q_L2</sub>        | I <sub>L2OUT</sub> = 0μA  |   |      | 1     | 1.7  | μA                |
|   |                          | I <sub>L2OUT</sub> = 0μA, Switch mode.  |   |      | 0.35  | 0.7  |                   |
| Quiescent Supply Current in Dropout   | I <sub>Q_L2_DRP</sub>    | I <sub>L2OUT</sub> = 0μA, V <sub>L2IN</sub> = +2.9V, LDO2VSet = 0x15 (+3V)        |   |      | 2.2   | 3.7  | μA                |
| Maximum Output Current  | I <sub>L2OUT_MAX</sub>   | V <sub>L2IN</sub> > +1.8V   |   | 100  |       |      | mA                |
| Output Voltage  | V <sub>L2OUT</sub>       | 100mV step resolution   |   | 0.9  |       | 4    | V                 |
| Output Accuracy   | ACC_LDO2                 | (V <sub>L2OUT</sub> + 0.5V) ≤ V <sub>L2IN</sub> ≤ +5.5V, I <sub>L2OUT</sub> = 1mA |   | -2.9 |       | +2.9 | %                 |
| Dropout Voltage   | V <sub>DRP_L2</sub>      | V <sub>L2IN</sub> = +3V, LDO2VSet = 0x16 (+3.1V), I <sub>L2OUT</sub> = 100mA      |   |      |       | 100  | mV                |
|   |                          | V <sub>L2IN</sub> = +1.85V, LDO2VSet = 0x0A (+1.9V), I <sub>L2OUT</sub> = 100mA   |   |      |       | 130  | mV                |

## Electrical Characteristics (continued)

(V<sub>BAT</sub> = +3.7V, T<sub>A</sub> = -20°C to +70°C, unless otherwise noted. Typical values are at T<sub>A</sub> = +25°C. C<sub>SFOUT</sub> = 1μF, C<sub>VDIG</sub> = 1μF, C<sub>CAP</sub> = 1μF, C<sub>SYST</sub> = 10μF, C<sub>BK1OUT</sub> = 10μF, C<sub>BK2OUT</sub> = 10μF, C<sub>L1IN</sub> = 1μF, C<sub>L2IN</sub> = 1μF, C<sub>L1OUT</sub> = 1μF, C<sub>L2OUT</sub> = 1μF, C<sub>CPP</sub> = 27nF, C<sub>BSTOUT</sub> = 10μF, C<sub>BBOU</sub> = 10μF, L<sub>BK1</sub> = 2.2μH, L<sub>BK2</sub> = 2.2μH, L<sub>BSTOUT</sub> = 4.7μH, L<sub>BBOU</sub> = 4.7μH). (Note 1)

| PARAMETER                               | SYMBOL                    | CONDITIONS  |  | MIN   | TYP   | MAX   | UNITS             |
|---|---------------------------|---|--|-------|-------|-------|-------------------|
| Line Regulation Error                   | V <sub>LINE_REG_L2</sub>  | V <sub>L2IN</sub> = (V <sub>L2OUT</sub> + 0.5V) to +5.5V                          |  | -0.38 |       | +0.38 | %/V               |
| Load Regulation Error                   | V <sub>LOAD_REG_L2</sub>  | +1.8V ≤ V <sub>L2IN</sub> ≤ +5.5V<br>I <sub>L2OUT</sub> = 100μA to 100mA          |  |       | 0.002 | 0.005 | %/mA              |
| Line Transient                          | V <sub>LINE_TRAN_L2</sub> | V <sub>L2IN</sub> = +4V to +5V, 200ns rise time                                   |  |       | ±35   |       | mV                |
|   |                           | V <sub>L2IN</sub> = +4V to +5V, 1μs rise time                                     |  |       | ±25   |       |                   |
| Load Transient                          | V <sub>LOAD_TRAN_L2</sub> | I <sub>L2OUT</sub> = 0mA to 10mA, 200ns rise time                                 |  |       | 100   |       | mV                |
|   |                           | I <sub>L2OUT</sub> = 0mA to 100mA, 200ns rise time                                |  |       | 200   |       |                   |
| Passive Discharge Resistance            | R <sub>PDL_L2</sub>       |   |  | 5     | 10    | 15    | kΩ                |
| Active Discharge Current                | I <sub>ACTDL_L2</sub>     |   |  | 8     | 22    | 40    | mA                |
| Switch Mode On-Resistance               | R <sub>ON_L2</sub>        | Switch mode   | V <sub>L2IN</sub> = +2.7V,<br>I <sub>L2OUT</sub> = 100mA |       |       | 0.7   | Ω                 |
|   |                           |   | V <sub>L2IN</sub> = +1.8V,<br>I <sub>L2OUT</sub> = 50mA  |       |       | 1     |                   |
|   |                           |   | V <sub>L2IN</sub> = +1.2V,<br>I <sub>L2OUT</sub> = 5mA   |       |       | 2.3   |                   |
| Turn-On Time                            | t <sub>ON_L2</sub>        | I <sub>L2OUT</sub> = 0mA, time from 10% to 90% of LDO2VSet                        |  |       | 1.5   |       | ms                |
|   |                           | I <sub>L2OUT</sub> = 0mA, time from 10% to 90% of V <sub>L2IN</sub> . Switch mode |  |       | 0.26  |       |                   |
| Short Circuit Current Limit             | I <sub>SHRT_L2</sub>      | V <sub>L2IN</sub> = +2.7V, V <sub>L2OUT</sub> = 0V                                |  | 225   | 360   | 555   | mA                |
|   |                           | V <sub>L2IN</sub> = +2.7V, V <sub>L2OUT</sub> = 0V, Switch mode                   |  | 210   | 350   | 540   |                   |
| Thermal Shutdown Temperature            | T <sub>SHDN_L2</sub>      | T <sub>J</sub> rising   |  |       | 150   |       | °C                |
| Thermal Shutdown Temperature Hysteresis | T <sub>SHDN_HYS_L2</sub>  |   |  |       | 20    |       | °C                |
| Output Noise                            |                           | 10Hz to 100kHz, V <sub>L2IN</sub> = +5V   | V <sub>L2OUT</sub> = +3.3V                               |       | 150   |       | μV <sub>RMS</sub> |
|   |                           |   | V <sub>L2OUT</sub> = +2.5V                               |       | 125   |       |                   |
|   |                           |   | V <sub>L2OUT</sub> = +1.2V                               |       | 90    |       |                   |
|   |                           |   | V <sub>L2OUT</sub> = +0.9V                               |       | 80    |       |                   |
| UVLO                                    | V <sub>L2IN_UVLO</sub>    | V <sub>L2IN</sub> falling   |  | 1.05  | 1.35  |       | V                 |
|   |                           | V <sub>L2IN</sub> rising  |  |       | 1.36  | 1.69  |                   |

**Electrical Characteristics (continued)**

(V<sub>BAT</sub> = +3.7V, T<sub>A</sub> = -20°C to +70°C, unless otherwise noted. Typical values are at T<sub>A</sub> = +25°C. C<sub>SFOUT</sub> = 1μF, C<sub>VDIG</sub> = 1μF, C<sub>CAP</sub> = 1μF, C<sub>SYST</sub> = 10μF, C<sub>BK1OUT</sub> = 10μF, C<sub>BK2OUT</sub> = 10μF, C<sub>L1IN</sub> = 1μF, C<sub>L2IN</sub> = 1μF, C<sub>L1OUT</sub> = 1μF, C<sub>L2OUT</sub> = 1μF, C<sub>CPP</sub> = 27nF, C<sub>BSTOUT</sub> = 10μF, C<sub>BBOU</sub> = 10μF, L<sub>BK1</sub> = 2.2μH, L<sub>BK2</sub> = 2.2μH, L<sub>BSTOUT</sub> = 4.7μH, L<sub>BBOU</sub> = 4.7μH). (Note 1)

| PARAMETER                                  | SYMBOL                  | CONDITIONS  | MIN  | TYP                    | MAX  | UNITS              |
|--|-------------------------|---|------|------------------------|------|--------------------|
| <b>CHARGE PUMP</b>                         |                         |   |      |                        |      |                    |
| Input Voltage                              | V <sub>CPIN</sub>       | Input voltage = V <sub>SYST</sub>   | 2.7  |                        | 5.5  | V                  |
| Quiescent Supply Current                   | I <sub>Q_CP_5V</sub>    | I <sub>CPOUT</sub> = 0μA, CPVSet = 1 (+5V)  |      | 2                      | 3.5  | μA                 |
|  | I <sub>Q_CP_6.6V</sub>  | I <sub>CPOUT</sub> = 0μA, CPVSet = 0 (+6.6V)  |      | 2.2                    | 4.3  |                    |
| CPOUT Output Voltage                       | V <sub>CPOUT</sub>      | CPVSet = 0, I <sub>CPOUT</sub> = 10μA,<br>V <sub>SYST</sub> > +3.3V                       |      | 6.6                    |      | V                  |
|  |                         | CPVSet = 1, I <sub>CPOUT</sub> = 10μA   |      | 5                      |      |                    |
| Output Accuracy                            | ACC_CP                  | I <sub>CPOUT</sub> < 120μA, V <sub>SYST</sub> > +3.3V                                     | -3   |                        | +3   | %                  |
| Maximum Operative Output Current           | I <sub>CPOUT_MAX</sub>  | V <sub>SYST</sub> > +3.3V, -5% load regulation error                                      | 250  |                        |      | μA                 |
| Efficiency                                 | EFF_CP                  | CPVSet = 0 (+6.6V), I <sub>OUT</sub> = 10μA,<br>V <sub>SYST</sub> = +3.7V                 |      | 79                     |      | %                  |
| Max Charge Pump Frequency                  | FREQ_CP                 |   | 90   | 100                    | 110  | kHz                |
| Passive Discharge Resistance               | R <sub>PSV_CP</sub>     |   |      | 10                     |      | kΩ                 |
| <b>HAPTIC DRIVER</b>                       |                         |   |      |                        |      |                    |
| Input Voltage                              | V <sub>HD_IN</sub>      | Input voltage = V <sub>SYST</sub>   | 2.6  |                        | 5.5  | V                  |
| Quiescent Current                          | I <sub>HD_Q</sub>       | V <sub>DRP</sub> /V <sub>DRN</sub> = 0 to V <sub>SYST</sub>                               |      | 1300                   |      | μA                 |
| H-Bridge PWM Output Frequency              | f <sub>HD_PWM_OUT</sub> |   | 22.5 | 25                     | 27.5 | kHz                |
| H-Bridge PWM Output Duty Cycle Resolution  | D <sub>HD_PWM_OUT</sub> | 7 bits  |      | V <sub>SYST</sub> /128 |      | %V <sub>SYST</sub> |
| H-Bridge Output Impedance in Off State     | R <sub>HD_OFF</sub>     | HptOffImp = 1   |      | 15                     |      | kΩ                 |
|  |                         | HptOffImp = 0   |      | R <sub>HD_ON_LS</sub>  |      | Ω                  |
| H-Bridge Output Leakage in High-Z State    | I <sub>HD_LK_OUT</sub>  | During back EMF detection,<br>V <sub>DRP</sub> /V <sub>DRN</sub> = 0 to V <sub>SYST</sub> | -1   |                        | +1   | μA                 |
| H-Bridge On-Resistance                     | R <sub>HD_ON_HS</sub>   | High-side PMOS switch on,<br>300mA load   | 0.04 | 0.18                   | 0.5  | Ω                  |
|  | R <sub>HD_ON_LS</sub>   | Low-side NMOS switch on,<br>300mA load  | 0.04 | 0.18                   | 0.5  |                    |
| H-Bridge Overcurrent Protection Threshold  | I <sub>HD_OC_THR</sub>  | Rising current through high-side or low-side  | 600  | 1000                   | 1500 | mA                 |
| H-Bridge Overcurrent Protection Hysteresis | I <sub>HD_OC_HYS</sub>  |   |      | 130                    |      | mA                 |

**Electrical Characteristics (continued)**

( $V_{BAT} = +3.7V$ ,  $T_A = -20^{\circ}C$  to  $+70^{\circ}C$ , unless otherwise noted. Typical values are at  $T_A = +25^{\circ}C$ .  $C_{SFOUT} = 1\mu F$ ,  $C_{VDIG} = 1\mu F$ ,  $C_{CAP} = 1\mu F$ ,  $C_{SYS\_EFF} = 10\mu F$ ,  $C_{BK1OUT\_EFF} = 10\mu F$ ,  $C_{BK2OUT\_EFF} = 10\mu F$ ,  $C_{L1IN} = 1\mu F$ ,  $C_{L2IN} = 1\mu F$ ,  $C_{L1OUT} = 1\mu F$ ,  $C_{L2OUT} = 1\mu F$ ,  $C_{CPP} = 27nF$ ,  $C_{BSTOUT\_EFF} = 10\mu F$ ,  $C_{BBOU\_EFF} = 10\mu F$ ,  $L_{BK1} = 2.2\mu H$ ,  $L_{BK2} = 2.2\mu H$ ,  $L_{BSTOUT} = 4.7\mu H$ ,  $L_{BBOU} = 4.7\mu H$ ). (Note 1)

| PARAMETER  | SYMBOL              | CONDITIONS  | MIN                              | TYP | MAX                              | UNITS       |
|--|---------------------|---|----------------------------------|-----|----------------------------------|-------------|
| H-Bridge Thermal Shutdown Temperature Threshold  | $T_{HD\_SHDN\_THR}$ | Rising temperature  |                                  | 150 |                                  | $^{\circ}C$ |
| H-Bridge Thermal Shutdown Temperature Hysteresis | $T_{HD\_SHDN\_HYS}$ |   |                                  | 25  |                                  | $^{\circ}C$ |
| PWM Input Frequency                              | $f_{HD\_INPWM}$     |   | 10                               |     | 250                              | kHz         |
| LRA Resonance Frequency Tracking Range           | $f_{HD\_LRA}$       | See <i>Haptic Driver</i> section  | max of (200k/IniGss [11:0], 100) |     | min of (800k/IniGss [11:0], 500) | Hz          |
| Startup Latency                                  | $t_{HD\_START}$     | Time from command to vibration response. See <i>Haptic Driver</i> section           |                                  | 10  | 12                               | ms          |
| <b>LED CURRENT SINKS</b>                         |                     |   |                                  |     |                                  |             |
| Maximum Input Voltage                            | $V_{IN\_LED\_MAX}$  |   |                                  |     | 20                               | V           |
| Quiescent Current                                | $I_{Q\_LED}$        | All LEDs on, $V_{SYS} = 3.7V$   |                                  | 245 | 370                              | $\mu A$     |
| Current Sink Setting Range                       | $I_{LED\_RNG}$      | LEDISet = 00 (0.6mA steps)  | 0.6                              |     | 15                               | mA          |
|  |                     | LEDISet = 01 (1mA steps)  | 1                                |     | 25                               |             |
|  |                     | LEDISet = 10 (1.2mA steps)  | 1.2                              |     | 30                               |             |
| LED Current Accuracy                             | ACC_LED             | $I_{LED\_} = 13mA$ , $T_A = +25^{\circ}C$ , $V_{LED\_} = +0.7V$ to $+20V$           | -2                               |     | +2                               | %           |
|  |                     | $I_{LED\_} = 13mA$ , $V_{LED\_} = +0.7V$ to $+20V$                                  | -4                               |     | +4                               |             |
|  |                     | $I_{LED\_} = 0.6mA$ to $30mA$ , $V_{LED\_} = +0.7V$ to $+20V$ , $T_A = 25^{\circ}C$ | -5                               |     | +5                               | %           |
|  |                     | $I_{LED\_} = 0.6mA$ to $30mA$ , $V_{LED\_} = +0.7V$ to $+20V$                       | -6                               |     | +6                               | %           |
| LED Dropout Voltage                              | $V_{LED\_DROP}$     | $I_{LED\_SET} = 5mA$ , $I_{LED\_} = 0.9 \times 5mA$                                 |                                  | 110 | 160                              | mV          |
|  |                     | $I_{LED\_SET} = 25mA$ , $I_{LED\_} = 0.9 \times 25mA$                               |                                  | 145 | 215                              |             |
|  |                     | $I_{LED\_SET} = 30mA$ , $I_{LED\_} = 0.9 \times 30mA$                               |                                  | 175 | 270                              |             |
| Leakage in Shutdown                              | $I_{LK\_LED}$       | $V_{LED\_} = +20V$  |                                  |     | 0.1                              | $\mu A$     |
| Open-LED Detection Threshold                     | $V_{LED\_DET}$      | LED_ enabled, LEDISet = 00, falling edge  | 61                               | 92  | 140                              | mV          |

**Electrical Characteristics (continued)**

(V<sub>BAT</sub> = +3.7V, T<sub>A</sub> = -20°C to +70°C, unless otherwise noted. Typical values are at T<sub>A</sub> = +25°C. C<sub>SFOUT</sub> = 1μF, C<sub>VDIG</sub> = 1μF, C<sub>CAP</sub> = 1μF, C<sub>SYST</sub> = 10μF, C<sub>BK1OUT</sub> = 10μF, C<sub>BK2OUT</sub> = 10μF, C<sub>L1IN</sub> = 1μF, C<sub>L2IN</sub> = 1μF, C<sub>L1OUT</sub> = 1μF, C<sub>L2OUT</sub> = 1μF, C<sub>CPP</sub> = 27nF, C<sub>BSTOUT</sub> = 10μF, C<sub>BBOU</sub> = 10μF, L<sub>BK1</sub> = 2.2μH, L<sub>BK2</sub> = 2.2μH, L<sub>BSTOUT</sub> = 4.7μH, L<sub>BBOU</sub> = 4.7μH). (Note 1)

| PARAMETER   | SYMBOL              | CONDITIONS  | MIN                 | TYP                      | MAX     | UNITS   |
|---|---------------------|---|---------------------|--------------------------|---------|---------|
| <b>FUEL GAUGE</b>                                     |                     |   |                     |                          |         |         |
| Supply Voltage  | V <sub>CELL</sub>   | (Note 3)  | 2.5                 |                          | 4.5     | V       |
| Fuel-Gauge SOC Reset<br>(V <sub>RESET</sub> Register) | V <sub>RST</sub>    | Configuration range, in 40mV steps  | 2.28                |                          | 3.48    | V       |
|   |                     | Trimmed at 3V   | 2.85                | 3.0                      | 3.15    |         |
| Supply Current  | I <sub>DD0</sub>    | Sleep mode  |                     | 0.5                      | 2       | μA      |
|   |                     | Hibernate mode, reset comparator disabled (V <sub>RESET</sub> .Dis = 1)                           |                     | 3                        | 5       |         |
|   |                     | Hibernate mode, reset comparator enabled (V <sub>RESET</sub> .Dis = 0)                            |                     | 4                        | 6       |         |
|   | I <sub>DD1</sub>    | Active mode   |                     | 23                       | 40      |         |
| Time Base Accuracy                                    | t <sub>ERR</sub>    | Active, hibernate modes (Note 4)  | -3.5                |                          | +3.5    | %       |
| AD Sample Period                                      |                     | Active mode   |                     | 250                      |         | ms      |
|   |                     | Hibernate mode  |                     | 45                       |         | s       |
| Voltage Error   | V <sub>ERR</sub>    | V <sub>CELL</sub> = 3.6V, T <sub>A</sub> = +25°C (Note 5)   | -9                  |                          | +6      | mV/cell |
|   |                     | T <sub>A</sub> = -20°C to +70°C   | -23                 |                          | +20     |         |
| Voltage-Measurement Resolution                        |                     |   |                     | 1.25                     |         | mV/cell |
| BAT-to-Cell On-Resistance                             | R <sub>ON_ISO</sub> | V <sub>BAT</sub> = 3.7V   |                     | 15                       | 30      | Ω       |
| Bus Low-Detection Timeout                             | t <sub>SLEEP</sub>  | (Notes 6, 7)  |                     | 2.125                    |         | s       |
| <b>DIGITAL</b>  |                     |   |                     |                          |         |         |
| SDA, SCL, MPC_, PFN_ Input Leakage Current            | I <sub>LK_IO</sub>  | Input pullup/pulldown resistances disabled, input voltage from 0 to +5.5V                         | -1                  |                          | +1      | μA      |
| SDA, SCL, MPC_ Input Logic-High                       | V <sub>IO_IH</sub>  |   | 1.4                 |                          |         | V       |
| SDA, SCL, MPC_ Input Logic-Low                        | V <sub>IO_IL</sub>  |   |                     |                          | 0.5     | V       |
| PFN_ Input Logic-High                                 | V <sub>PFN_IH</sub> | (Note 2)  |                     | 0.7 x V <sub>CCINT</sub> |         | V       |
| PFN_ Input Logic-Low                                  | V <sub>PFN_IL</sub> | (Note 2)  |                     | 0.3 x V <sub>CCINT</sub> |         | V       |
| MPC_, PFN_ Input Pullup Resistance                    | R <sub>IO_UP</sub>  | Pullup resistance to V <sub>CCINT</sub> (Note 2)  |                     | 170                      |         | kΩ      |
| MPC_, PFN_ Input Pulldown Resistance                  | R <sub>IO_PD</sub>  |   |                     | 170                      |         | kΩ      |
| MPC_ Output Logic-High                                | V <sub>IO_OH</sub>  | I <sub>OH</sub> = 1mA, MPC_ configured as push-pull output, pullup voltage is V <sub>BK2OUT</sub> | V <sub>BK2OUT</sub> |                          | T - 0.4 | V       |



**Electrical Characteristics (continued)**

( $V_{BAT} = +3.7V$ ,  $T_A = -20^{\circ}C$  to  $+70^{\circ}C$ , unless otherwise noted. Typical values are at  $T_A = +25^{\circ}C$ .  $C_{SFOUT} = 1\mu F$ ,  $C_{VDIG} = 1\mu F$ ,  $C_{CAP} = 1\mu F$ ,  $C_{SYS\_EFF} = 10\mu F$ ,  $C_{BK1OUT\_EFF} = 10\mu F$ ,  $C_{BK2OUT\_EFF} = 10\mu F$ ,  $C_{L1IN} = 1\mu F$ ,  $C_{L2IN} = 1\mu F$ ,  $C_{L1OUT} = 1\mu F$ ,  $C_{L2OUT} = 1\mu F$ ,  $C_{CPP} = 27nF$ ,  $C_{BSTOUT\_EFF} = 10\mu F$ ,  $C_{BBOUT\_EFF} = 10\mu F$ ,  $L_{BK1} = 2.2\mu H$ ,  $L_{BK2} = 2.2\mu H$ ,  $L_{BSTOUT} = 4.7\mu H$ ,  $L_{BBOUT} = 4.7\mu H$ ). (Note 1)

| PARAMETER   | SYMBOL        | CONDITIONS                  | MIN | TYP | MAX | UNITS   |
|---|---------------|-----------------------------|-----|-----|-----|---------|
| SDA, $\overline{RST}$ , $\overline{INT}$ , MPC_,<br>PFN_ Output Logic-Low | $V_{IO\_OL}$  | $I_{OL} = 4mA$              |     |     | 0.4 | V       |
| SDA, SCL Bus Low-<br>Detection Current                                    | $I_{PD}$      | $V_{SDA} = V_{SCL} = +0.4V$ |     | 0.2 | 0.4 | $\mu A$ |
| SCL Clock Frequency   | $f_{SCL}$     |                             | 0   |     | 400 | kHz     |
| Bus Free Time Between<br>a STOP and START<br>Condition                    | $t_{BUF}$     |                             | 1.3 |     |     | $\mu s$ |
| START Condition<br>(repeated) Hold Time                                   | $t_{HD\_STA}$ |                             | 0.6 |     |     | $\mu s$ |
| Low Period of SCL Clock   | $t_{LOW}$     |                             | 1.3 |     |     | $\mu s$ |
| High Period of SCL Clock  | $t_{HIGH}$    |                             | 0.6 |     |     | $\mu s$ |
| Setup Time for a<br>Repeated START<br>Condition                           | $t_{SU\_STA}$ |                             | 0.6 |     |     | $\mu s$ |
| Data Hold Time  | $t_{HD\_DAT}$ |                             | 0   |     | 0.9 | $\mu s$ |
| Data Setup Time   | $t_{SU\_DAT}$ |                             | 100 |     |     | $\mu s$ |
| Setup Time for a STOP<br>Condition  | $t_{SU\_STO}$ |                             | 0.6 |     |     | $\mu s$ |
| Spike Pulse Widths<br>Suppressed by Input Filter                          | $t_{SP}$      |                             | 50  |     |     | ns      |

**Note 1:** All devices are 100% production tested at  $T_A = +25^{\circ}C$ . Limits over the operating temperature range are guaranteed by design.

**Note 2:**  $V_{CCINT}$  is an internal voltage supply generated from either  $V_{BAT}$  or  $V_{CAP}$ . The source is determined by the following:

IF  $[(V_{CHGIN} > V_{CHGIN\_DET} \text{ AND } V_{CAP} > V_{CAP\_OK}) \text{ OR } V_{CAP} > (V_{BAT} + V_{THSWOVER})]$   
THEN  $V_{CCINT} = V_{CAP}$

ELSE

$V_{CCINT} = V_{BAT}$

Where  $V_{THSWOVER} = [0-300]mV$

**Note 3:** All voltages are referenced to GND.

**Note 4:** Test performed on unmounted/unsoldered parts.

**Note 5:** The voltage is trimmed and verified with 16x averaging.

**Note 6:** Fuel Gauge enters shutdown mode after  $SCL < V_{IL}$  and  $SDA < V_{IL}$  for longer than  $t_{SLEEP}$ .

**Note 7:** Guaranteed by design.

Typical Operating Characteristics

V<sub>BAT</sub> = +3.7V, C<sub>SFOUT</sub> = 1μF, C<sub>VDIG</sub> = 1μF, C<sub>CAP</sub> = 1μF, C<sub>SYST</sub> = 10μF, C<sub>BK1OUT\_EFF</sub> = 15μF, C<sub>BK2OUT\_EFF</sub> = 10μF, C<sub>L1IN</sub> = 22μF, C<sub>L2IN</sub> = 22μF, C<sub>L1OUT\_EFF</sub> = 15μF, C<sub>L2OUT\_EFF</sub> = 10μF, C<sub>CPP</sub> = 27nF, C<sub>BSTOUT\_EFF</sub> = 10μF, C<sub>BBOU\_T\_EFF</sub> = 10μF, L<sub>BK1</sub> = 2.2μH, L<sub>BK2</sub> = 2.2μH, L<sub>BSTOUT</sub> = 4.7μH, L<sub>BBOU\_T</sub> = 4.7μH, T<sub>A</sub> = +25°C, unless otherwise noted.

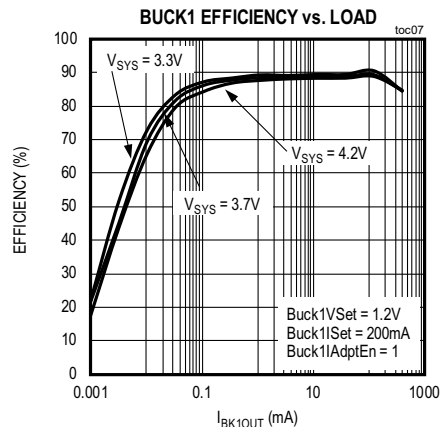
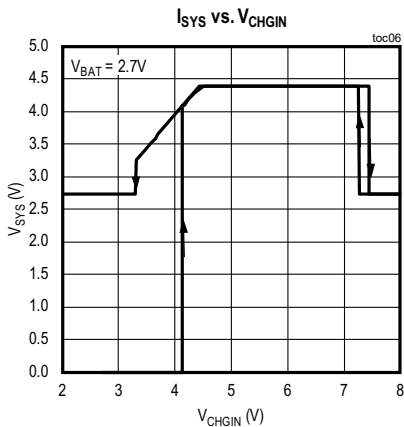
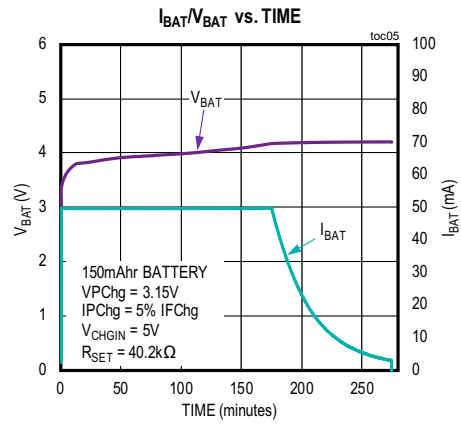
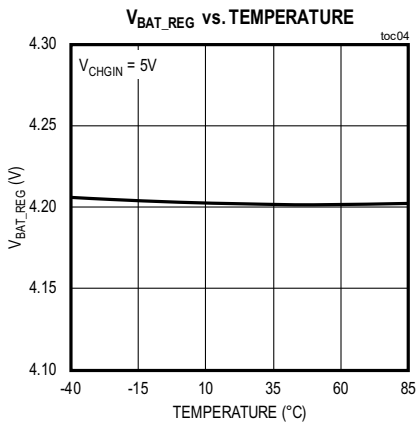
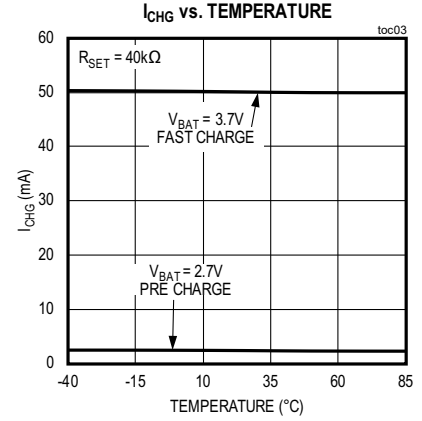
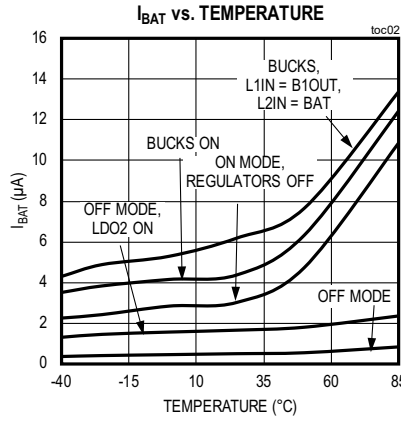
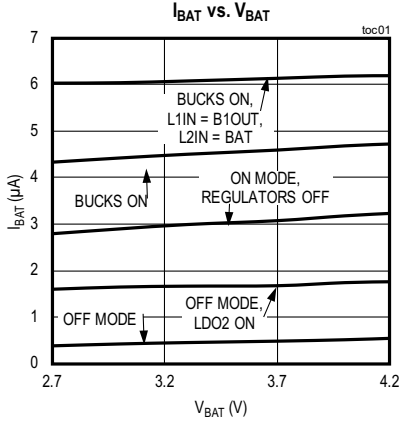

Typical Operating Characteristics (continued)

V<sub>BAT</sub> = +3.7V, C<sub>SFOUT</sub> = 1μF, C<sub>V<sub>DIG</sub></sub> = 1μF, C<sub>CAP</sub> = 1μF, C<sub>SY<sub>S</sub></sub> = 10μF, C<sub>BK1OUT\_EFF</sub> = 15μF, C<sub>BK2OUT\_EFF</sub> = 10μF, C<sub>L1IN</sub> = 22μF, C<sub>L2IN</sub> = 22μF, C<sub>L1OUT\_EFF</sub> = 15μF, C<sub>L2OUT\_EFF</sub> = 10μF, C<sub>CPP</sub> = 27nF, C<sub>BSTOUT\_EFF</sub> = 10μF, C<sub>BBOU<sub>T</sub></sub>\_EFF = 10μF, L<sub>BK1</sub> = 2.2μH, L<sub>BK2</sub> = 2.2μH, L<sub>BSTOUT</sub> = 4.7μH, L<sub>BBOU<sub>T</sub></sub> = 4.7μH, T<sub>A</sub> = +25°C, unless otherwise noted.

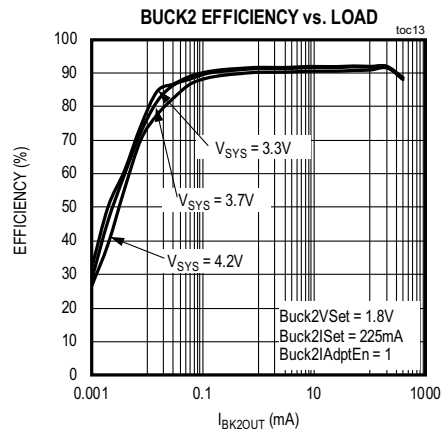
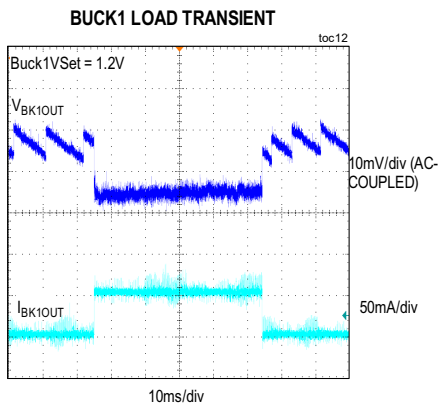
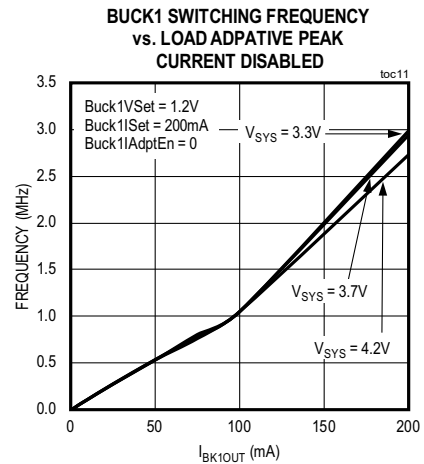
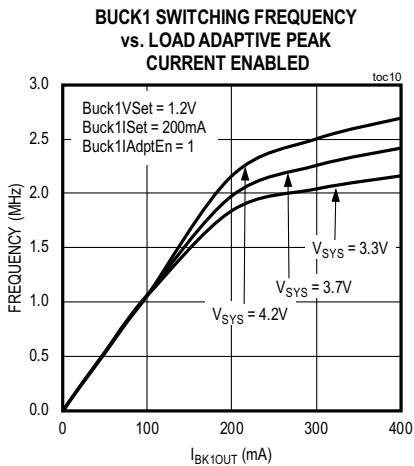
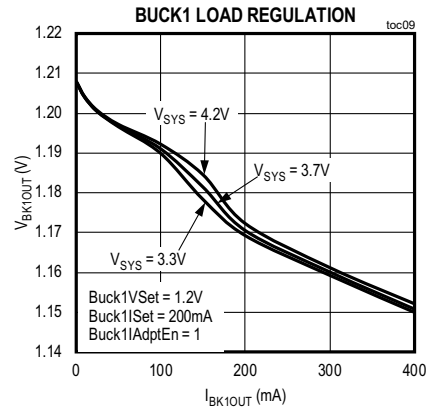
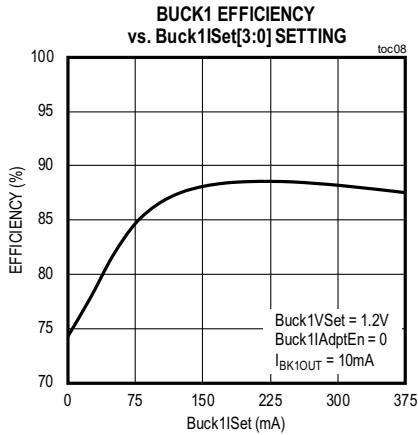

Typical Operating Characteristics (continued)

V<sub>BAT</sub> = +3.7V, C<sub>SFOUT</sub> = 1μF, C<sub>V<sub>DIG</sub></sub> = 1μF, C<sub>CAP</sub> = 1μF, C<sub>SY<sub>S</sub></sub> = 10μF, C<sub>BK1OUT\_EFF</sub> = 15μF, C<sub>BK2OUT\_EFF</sub> = 10μF, C<sub>L1IN</sub> = 22μF, C<sub>L2IN</sub> = 22μF, C<sub>L1OUT\_EFF</sub> = 15μF, C<sub>L2OUT\_EFF</sub> = 10μF, C<sub>CPP</sub> = 27nF, C<sub>BSTOUT\_EFF</sub> = 10μF, C<sub>BBOU<sub>T</sub></sub>\_EFF = 10μF, L<sub>BK1</sub> = 2.2μH, L<sub>BK2</sub> = 2.2μH, L<sub>BSTOUT</sub> = 4.7μH, L<sub>BBOU<sub>T</sub></sub> = 4.7μH, T<sub>A</sub> = +25°C, unless otherwise noted.

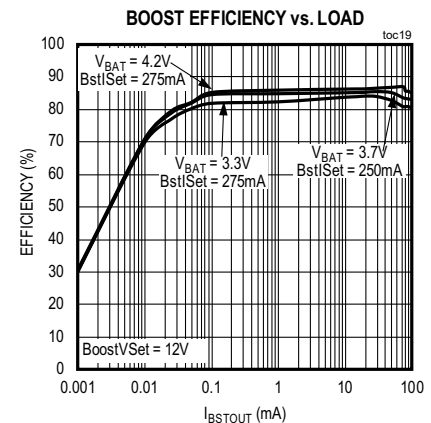
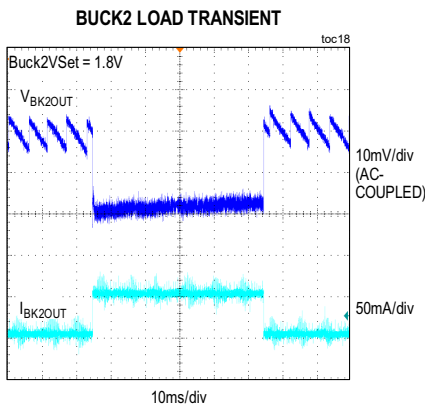
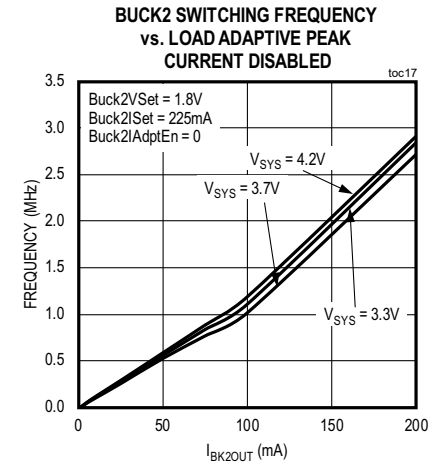
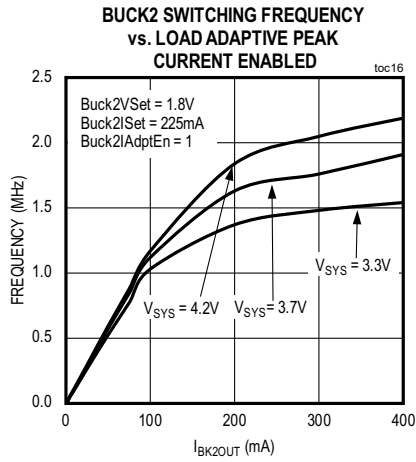
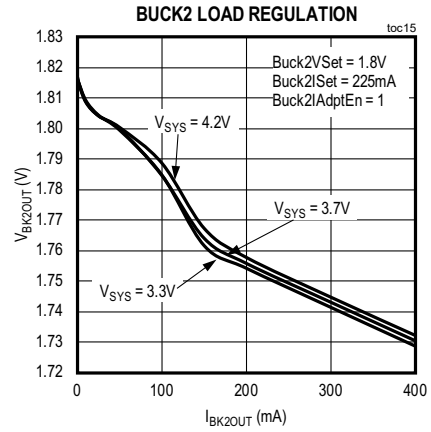
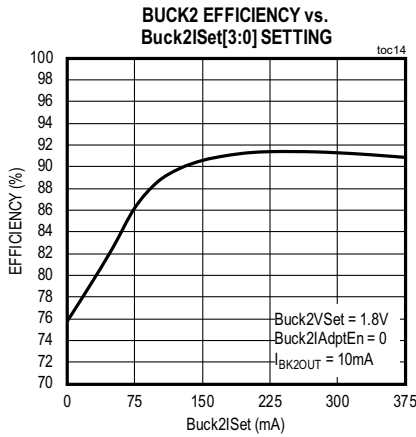

Typical Operating Characteristics (continued)

V<sub>BAT</sub> = +3.7V, C<sub>SFOUT</sub> = 1μF, C<sub>VDIG</sub> = 1μF, C<sub>CAP</sub> = 1μF, C<sub>SYN</sub> = 10μF, C<sub>BK1OUT\_EFF</sub> = 15μF, C<sub>BK2OUT\_EFF</sub> = 10μF, C<sub>L1IN</sub> = 22μF, C<sub>L2IN</sub> = 22μF, C<sub>L1OUT\_EFF</sub> = 15μF, C<sub>L2OUT\_EFF</sub> = 10μF, C<sub>CPP</sub> = 27nF, C<sub>BSTOUT\_EFF</sub> = 10μF, C<sub>BBOU</sub> = 10μF, L<sub>BK1</sub> = 2.2μH, L<sub>BK2</sub> = 2.2μH, L<sub>BSTOUT</sub> = 4.7μH, L<sub>BBOU</sub> = 4.7μH, T<sub>A</sub> = +25°C, unless otherwise noted.

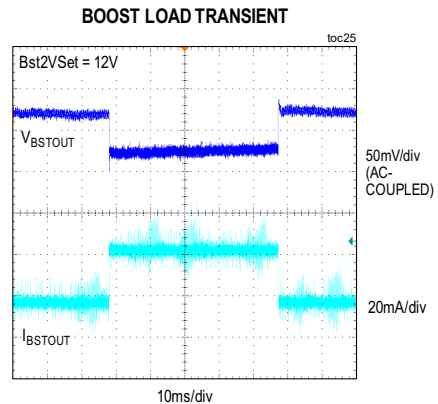
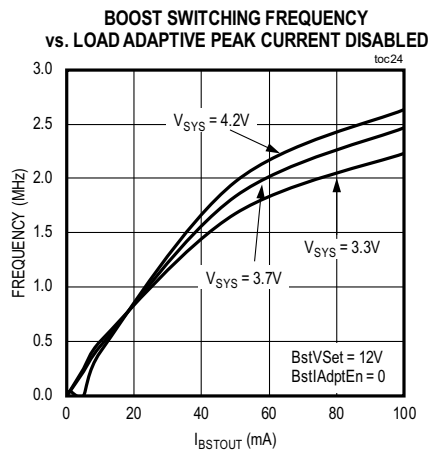
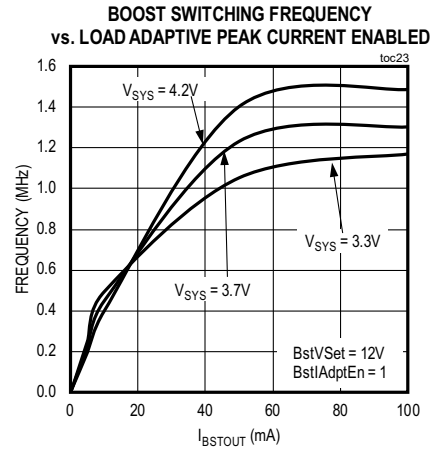
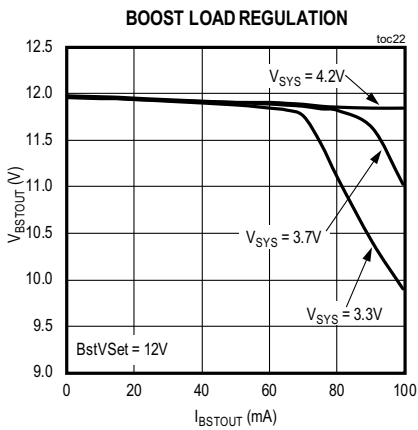
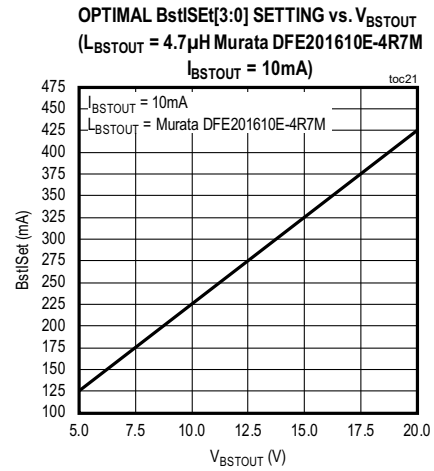
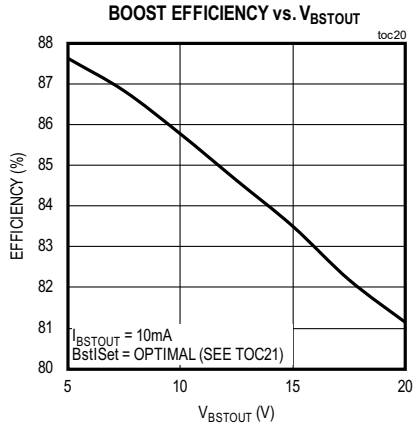

Typical Operating Characteristics (continued)

V<sub>BAT</sub> = +3.7V, C<sub>SFOUT</sub> = 1μF, C<sub>V<sub>DIG</sub></sub> = 1μF, C<sub>CAP</sub> = 1μF, C<sub>SY<sub>S</sub></sub> = 10μF, C<sub>BK1OUT\_EFF</sub> = 15μF, C<sub>BK2OUT\_EFF</sub> = 10μF, C<sub>L1IN</sub> = 22μF, C<sub>L2IN</sub> = 22μF, C<sub>L1OUT\_EFF</sub> = 15μF, C<sub>L2OUT\_EFF</sub> = 10μF, C<sub>CPP</sub> = 27nF, C<sub>BSTOUT\_EFF</sub> = 10μF, C<sub>B<sub>B</sub>OUT\_EFF</sub> = 10μF, L<sub>BK1</sub> = 2.2μH, L<sub>BK2</sub> = 2.2μH, L<sub>BSTOUT</sub> = 4.7μH, L<sub>B<sub>B</sub>OUT</sub> = 4.7μH, T<sub>A</sub> = +25°C, unless otherwise noted.

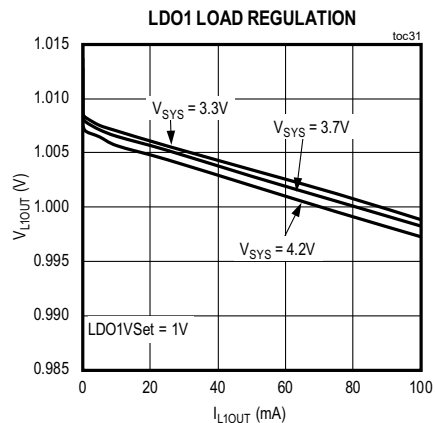
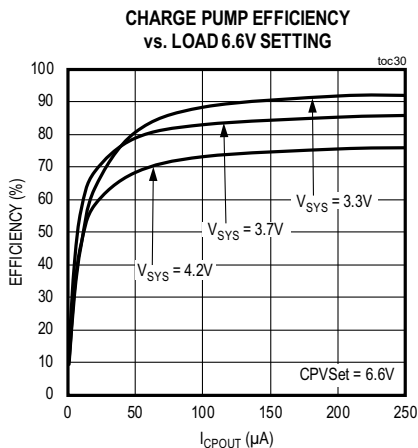
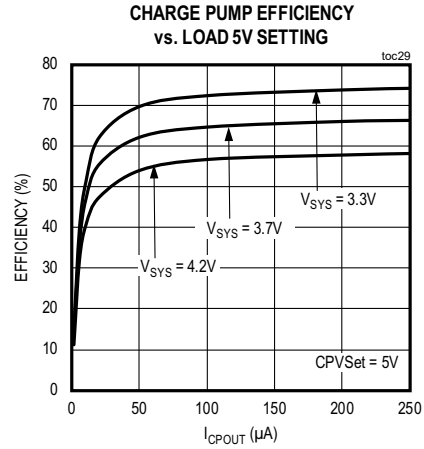
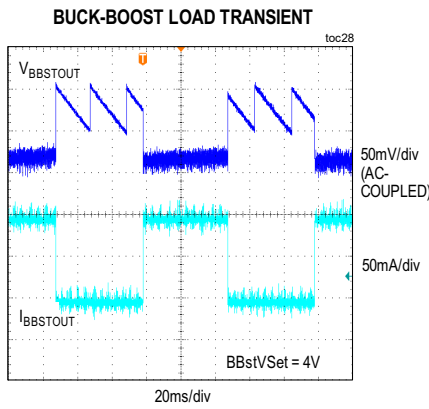
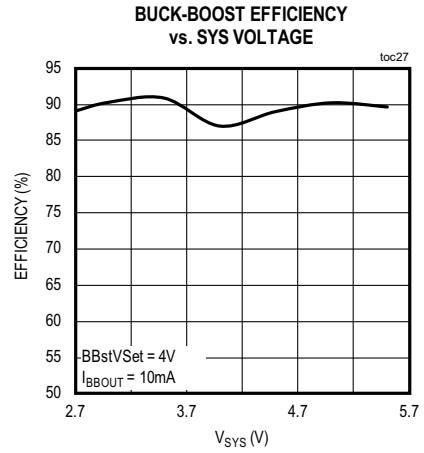
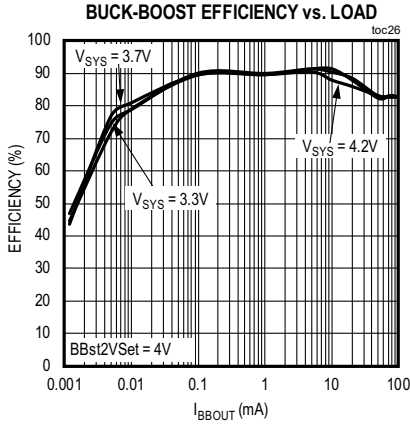

Typical Operating Characteristics (continued)

V<sub>BAT</sub> = +3.7V, C<sub>SFOUT</sub> = 1μF, C<sub>V<sub>DIG</sub></sub> = 1μF, C<sub>CAP</sub> = 1μF, C<sub>SY<sub>S</sub></sub> = 10μF, C<sub>BK1OUT\_EFF</sub> = 15μF, C<sub>BK2OUT\_EFF</sub> = 10μF, C<sub>L1IN</sub> = 22μF, C<sub>L2IN</sub> = 22μF, C<sub>L1OUT\_EFF</sub> = 15μF, C<sub>L2OUT\_EFF</sub> = 10μF, C<sub>CPP</sub> = 27nF, C<sub>BSTOUT\_EFF</sub> = 10μF, C<sub>BBOU<sub>T</sub></sub>\_EFF = 10μF, L<sub>BK1</sub> = 2.2μH, L<sub>BK2</sub> = 2.2μH, L<sub>BSTOUT</sub> = 4.7μH, L<sub>BBOU<sub>T</sub></sub> = 4.7μH, T<sub>A</sub> = +25°C, unless otherwise noted.

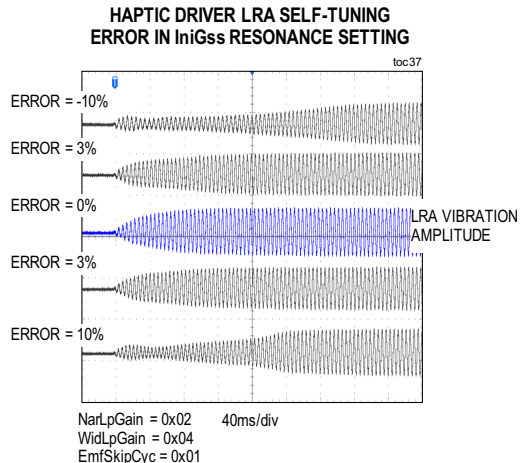
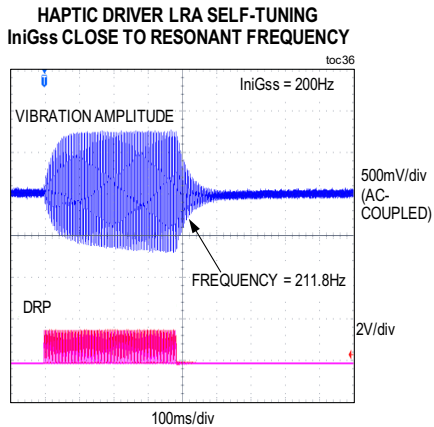
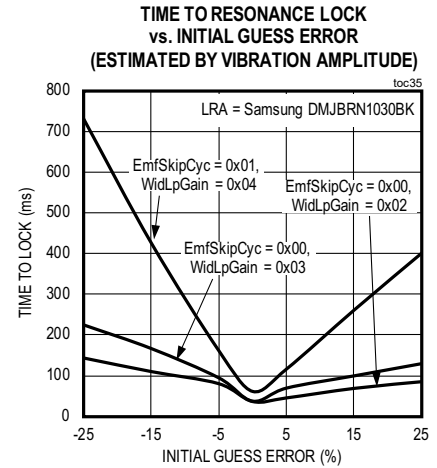
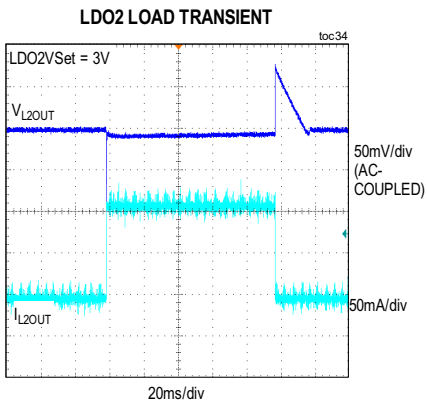
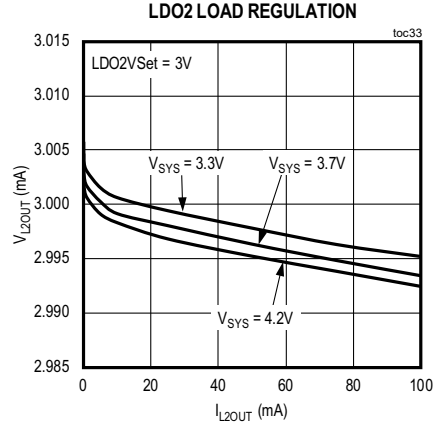
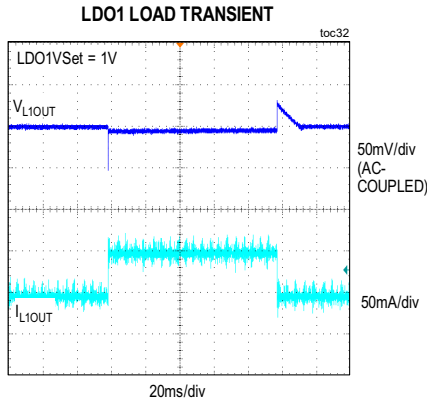

**Bump Configuration**

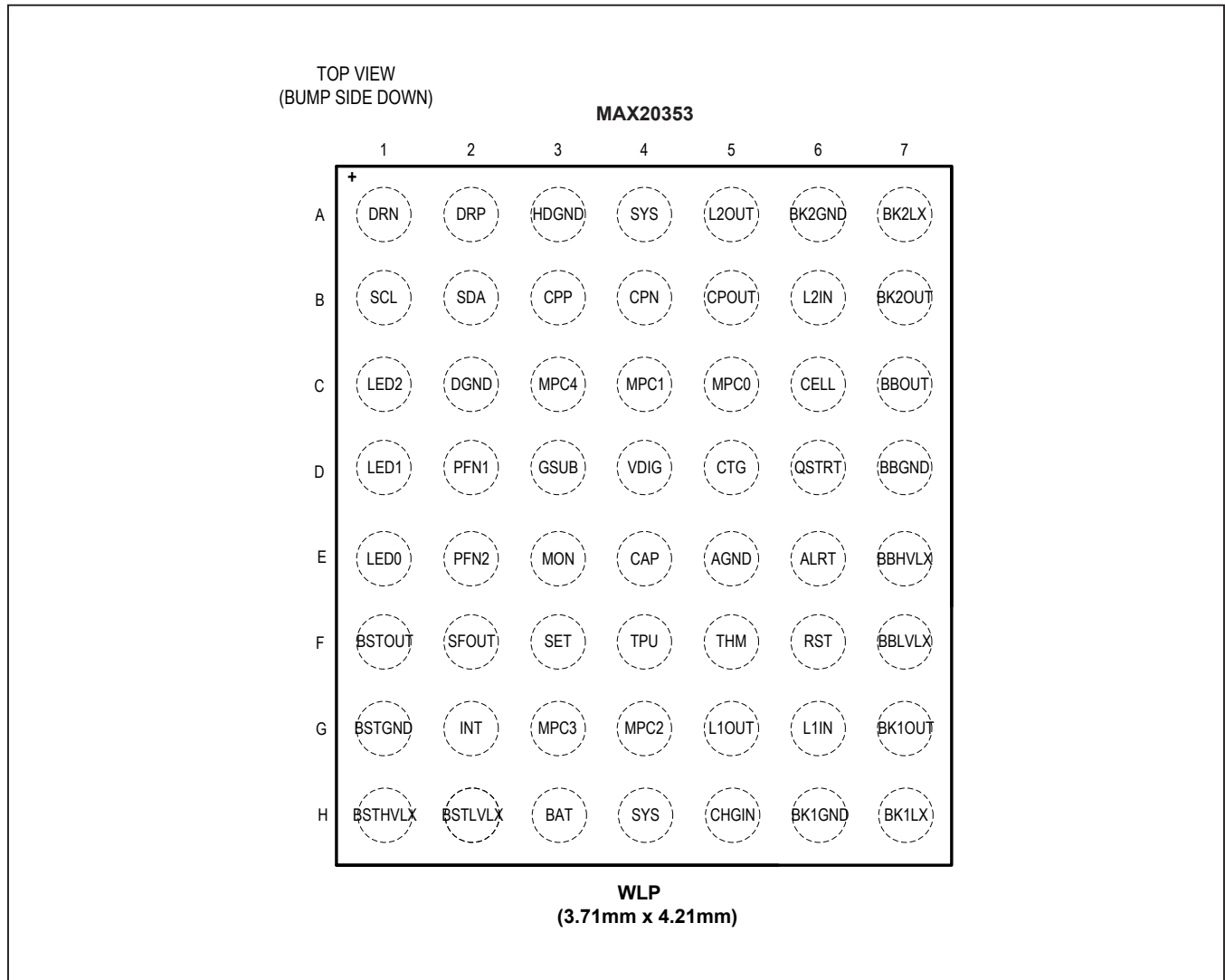



## Bump Description

| BUMP   | NAME   | FUNCTION  |
|--------|--------|---|
| A1     | DRN    | ERM/LRA Haptic Driver Negative Output.  |
| A2     | DRP    | ERM/LRA Haptic Driver Positive Output.  |
| A3     | HDGND  | Haptic Driver Ground.   |
| A4, H4 | SYS    | System Load Connection. Connect to the system load. Both SYS bumps should be connected on PCB through a low-impedance trace. Bypass common node with a minimum 10 $\mu$ F capacitor to GND. |
| A5     | L2OUT  | LDO Output. Bypass with 1 $\mu$ F capacitor to GND.   |
| A6     | BK2GND | Buck 2 Ground.  |
| A7     | BK2LX  | Buck2 Regulator Switch. Connect through 2.2 $\mu$ H inductor to BK2OUT.   |
| B1     | SCL    | I <sup>2</sup> C Serial Clock Input.  |
| B2     | SDA    | I <sup>2</sup> C Serial Data Input/Open-Drain Output.   |
| B3     | CPP    | Charge Pump Capacitor Positive Terminal. Connect 22nF (min), 33nF (max) capacitor to CPN.   |
| B4     | CPN    | Charge Pump Capacitor Negative Terminal. Connect to 22nF (min), 33nF (max) capacitor to CPP.  |
| B5     | CPOUT  | Charge Pump Output. Bypass with 1 $\mu$ F capacitor to GND.   |
| B6     | L2IN   | LDO2 Input. Bypass with 1 $\mu$ F capacitor to GND.   |
| B7     | BK2OUT | Buck2 Regulator Output. Bypass with 10 $\mu$ F capacitor to GND.  |
| C1     | LED2   | Current Sink Output 2.  |
| C2     | DGND   | Digital Ground.   |
| C3     | MPC4   | Multipurpose Control I/O 4.   |
| C4     | MPC1   | Multipurpose Control I/O 1.   |
| C5     | MPC0   | Multipurpose Control I/O 0.   |
| C6     | CELL   | Fuel Gauge Voltage. Bypass with 0.1 $\mu$ F capacitor to GND.   |
| C7     | BBOUT  | Buck-Boost Regulator Output. Bypass with 10 $\mu$ F capacitor to GND.   |
| D1     | LED1   | Current Sink Output 1.  |
| D2     | PFN1   | Configurable Power Mode Control Pin (e.g., $\overline{KIN}$ ).  |
| D3     | GSUB   | Substrate Connection. Connect to Ground.  |
| D4     | VDIG   | Internal Reference Supply. Bypass with 1 $\mu$ F capacitor to GND.  |
| D5     | CTG    | Fuel Gauge. Connect to GND.   |
| D6     | QSTRT  | Fuel Gauge Quick Start Input.   |
| D7     | BBGND  | Buck-Boost Ground.  |
| E1     | LED0   | Current Sink Output 0.  |
| E2     | PFN2   | Configurable Power Mode Control Pin (e.g., $\overline{KOUT}$ ).   |
| E3     | MON    | Monitor Multiplexer Output.   |
| E4     | CAP    | Internal Reference Supply. Bypass with 1 $\mu$ F capacitor to GND.  |
| E5     | AGND   | Analog Ground.  |

## Bump Description (continued)

| BUMP | NAME                     | FUNCTION   |
|------|--------------------------|--|
| E6   | $\overline{\text{ALRT}}$ | Fuel Gauge Alert Output.   |
| E7   | BBHVLX                   | Buck-Boost Regulator Switch HV side. Connect through a 3.3 $\mu$ H or 4.7 $\mu$ H inductor to BBLVLX.  |
| F1   | BSTOUT                   | Boost Regulator Output. Bypass with 10 $\mu$ F capacitor to GND.   |
| F2   | SFOUT                    | Safe Out LDO. Bypass with 1 $\mu$ F capacitor to GND.  |
| F3   | SET                      | External Resistor For Battery Charge Current Level Setting. Do not connect any capacitance on this pin; maximum allowed capacitance ( $C_{\text{SET}} < 5\mu\text{s}/R_{\text{SET}}\mu\text{F}$ ). |
| F4   | TPU                      | Battery Temperature Thermistor Measurement Pullup (Internally Connected To $V_{\text{DIG}}$ During Battery Temperature Thermistor Measurement). Do not exceed 1mA load on TPU.                     |
| F5   | THM                      | Battery Temperature Thermistor Measurement Connection.   |
| F6   | $\overline{\text{RST}}$  | Reset Output. Active-Low, Open-Drain Output.   |
| F7   | BBLVLX                   | Buck-Boost Regulator Switch LV Side. Connect through a 3.3 $\mu$ H or 4.7 $\mu$ H inductor to BBHVLX.  |
| G1   | BSTGND                   | High-Voltage Boost Ground.   |
| G2   | $\overline{\text{INT}}$  | Interrupt Open-Drain Output.   |
| G3   | MPC3                     | Multipurpose Control I/O 3.  |
| G4   | MPC2                     | Multipurpose Control I/O 2.  |
| G5   | L1OUT                    | LDO1 Output. Bypass with 1 $\mu$ F capacitor to GND.   |
| G6   | L1IN                     | LDO1 Input. Bypass with 1 $\mu$ F capacitor to GND.  |
| G7   | BK1OUT                   | Buck1 Regulator Output. Bypass with 10 $\mu$ F capacitor to GND.   |
| H1   | BSTHVLX                  | Boost Regulator Switch. Connect through a 4.7 $\mu$ H inductor to BSTLVLX.   |
| H2   | BSTLVLX                  | Boost Regulator Switch. Connect through a 4.7 $\mu$ H inductor to BSTHVLX.   |
| H3   | BAT                      | Battery Connection. Connect to positive battery terminal. Bypass with a minimum 1 $\mu$ F capacitor to GND.  |
| H5   | CHGIN                    | +28V/-5.5V Protected Charger Input. Bypass with 1 $\mu$ F capacitor to GND.  |
| H6   | BK1GND                   | Buck 1 Ground.   |
| H7   | BK1LX                    | Buck1 Regulator Switch. Connect through a 2.2 $\mu$ H inductor to BK1OUT.  |

**Note:** All capacitance values listed in this document refer to effective capacitance. Be sure to specify capacitors that will meet these requirements under typical operating conditions taking into consideration the effects of voltage and temperature.

Typical Application Diagram

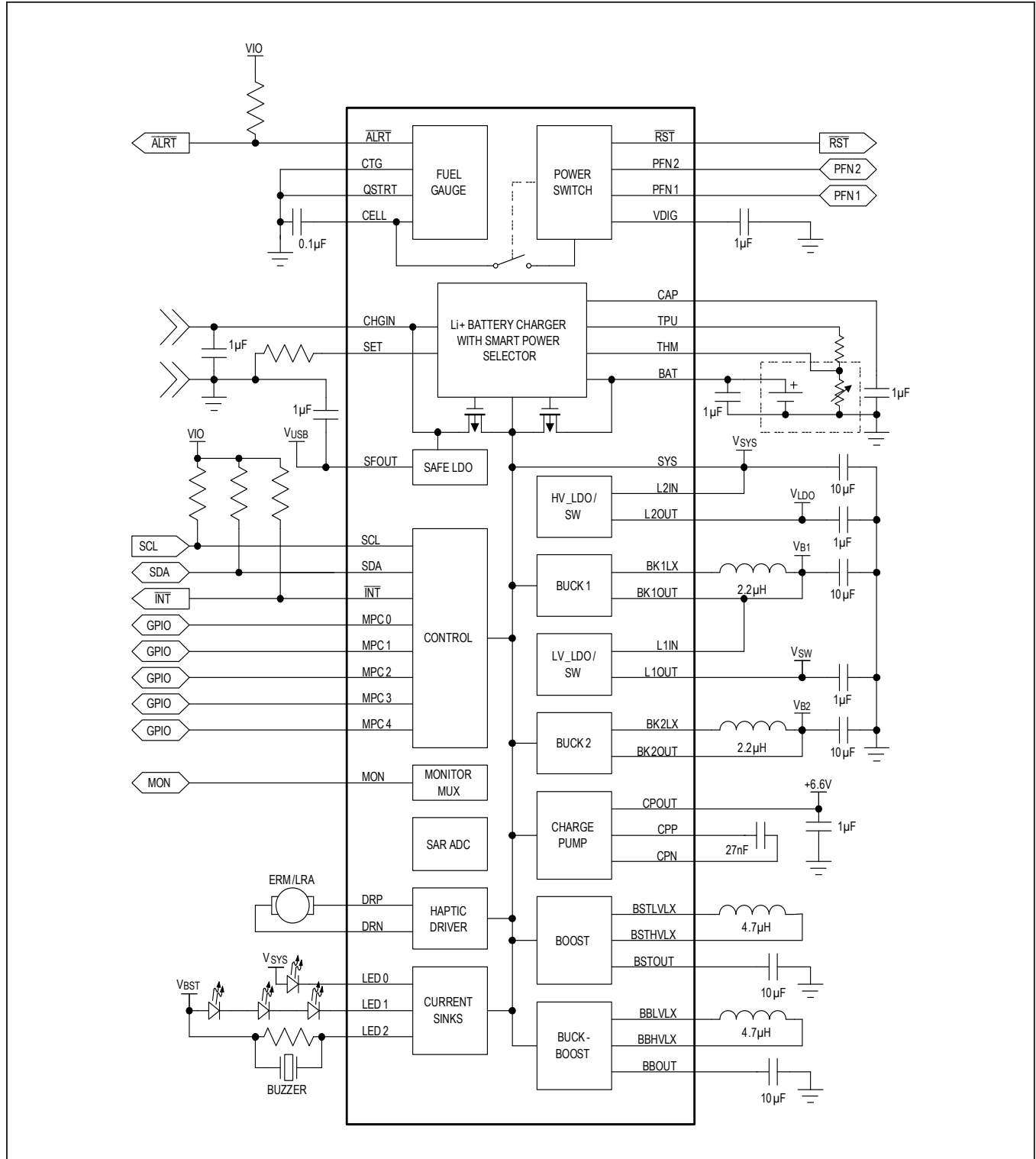

## Detailed Description

### Power Regulation

The MAX20353 features two high-efficiency, low quiescent current buck regulators, a buck-boost regulator, a high-voltage boost regulator, a charge pump, and two low quiescent current, low-dropout (LDO) linear regulators that are configurable as load switches. Additionally, a safe-output LDO is available when there is a valid voltage present at CHGIN. This SFOUT regulator's output is configurable to 3.3V or 5V. Excellent light-load efficiency allows the switching regulators to run continuously without significant energy cost. The buck and boost regulators can operate in a fixed peak current mode for low-current applications, as well as an adaptive peak current mode to improve load regulation, extend the high-efficiency range, and minimize capacitor size when more current is required.

### Dynamic Voltage Scaling (DVS)

The buck and LDO regulators feature the ability to change their output voltages through the AP interface without restarting. This function is called DVS. Additionally, Buck1 features the ability to quickly change its output voltage using a combination of MPC inputs and direct I<sup>2</sup>C registers. When this DVS mode is enabled, MPC0 and MPC1 select the Buck1 output voltage from a set of values defined in registers 0x23–0x25 and by opcode 0x35 (see [Table 1](#)). This bypasses the process of writing Buck1VSet through the AP interface and allows faster control of the Buck1 voltage. The Buck1 DVS function is enabled using the Buck1DVSEn bit (register 0x1F[0]).

### Power Switch and Reset Control

The MAX20353 features a power switch that provides the ability to execute a reset sequence or to turn off the main system power and enter Off mode to extend battery life.

Shutdown and reset events are triggered by an external control through the power function (PFN) control inputs, I<sup>2</sup>C commands, or if other conditions are met. The behavior of the PFN pins is preconfigured to support one of the multiple types of wearable application cases. [Table 2](#) describes the behavior of the PFN1 and PFN2 pins based on the PwrRstCfg[3:0] bits, while [Figure 1a](#) thru [Figure 1d](#)

shows basic flow diagrams associated with each mode. Both PFN pins have a 10ms debounce period to distinguish valid inputs followed by a PwrRstCfg dependent timing to execute the PFN function.

A soft reset sends a 10ms pulse on  $\overline{RST}$  and will either leave register settings unchanged or reset them to their default values depending on the device version (see [Table 201](#) for device settings). A hard reset on any device initiates a complete Power-On Reset sequence.

The device enters Off mode on cold boot (initial battery attach,  $V_{CHGIN} = 0V$ ) in response to a power-off I<sup>2</sup>C command, a valid PFN signal based on the PwrRstCfg[3:0] setting, or in the case of a UVLO condition on SYS. When the device is in Off mode, the BAT-SYS connection is opened and all functions are disabled except for the power function controller and LDO2 (if configured as always-on).

The MAX20353 will exit Off mode and turn the main power back on when there is a qualified PFN1 signal (PwrRstCfg[3:0] = 0000, 0001, 0110, 0111, 1000) or when a valid voltage is applied to CHGIN. In the powered-on state, the SYS node is enabled and other functions can be controlled through the I<sup>2</sup>C registers. When the power-on event occurs, the BAT-to-CELL switch is immediately closed and, 30ms later, the power path to SYS is enabled. This delay allows the fuel gauge to take an open cell measurement before the battery is loaded. Note that there is a relearning period to determine the state of the battery whenever the fuel gauge is disconnected. If the typical use case frequently switches the fuel gauge off and on, the user may consider permanently connecting CELL-to-BAT to avoid the relearning period. [Figure 2](#) illustrates a complete boot sequence coming out of the Off state.

**Table 1. Buck1 DVS MPC Values**

| MPC1 | MPC0 | Buck1 Voltage      |
|------|------|--------------------|
| 0    | 0    | Buck1VSet[5:0]     |
| 0    | 1    | Buck1DVSVSet1[5:0] |
| 1    | 0    | Buck1DVSVSet2[5:0] |
| 1    | 1    | Buck1DVSVSet3[5:0] |

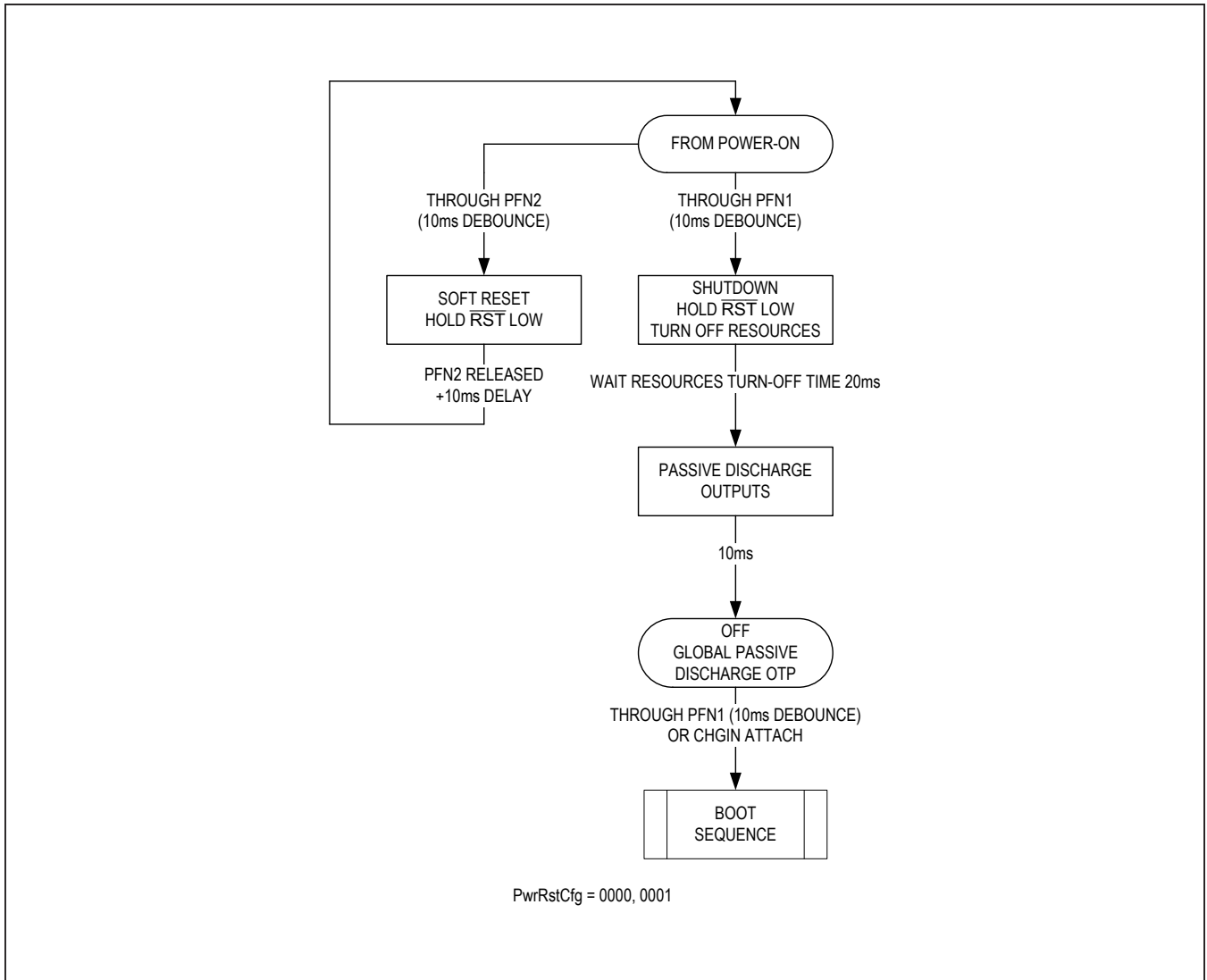

Figure 1a. PwrRstCfg = 0000 or 0001

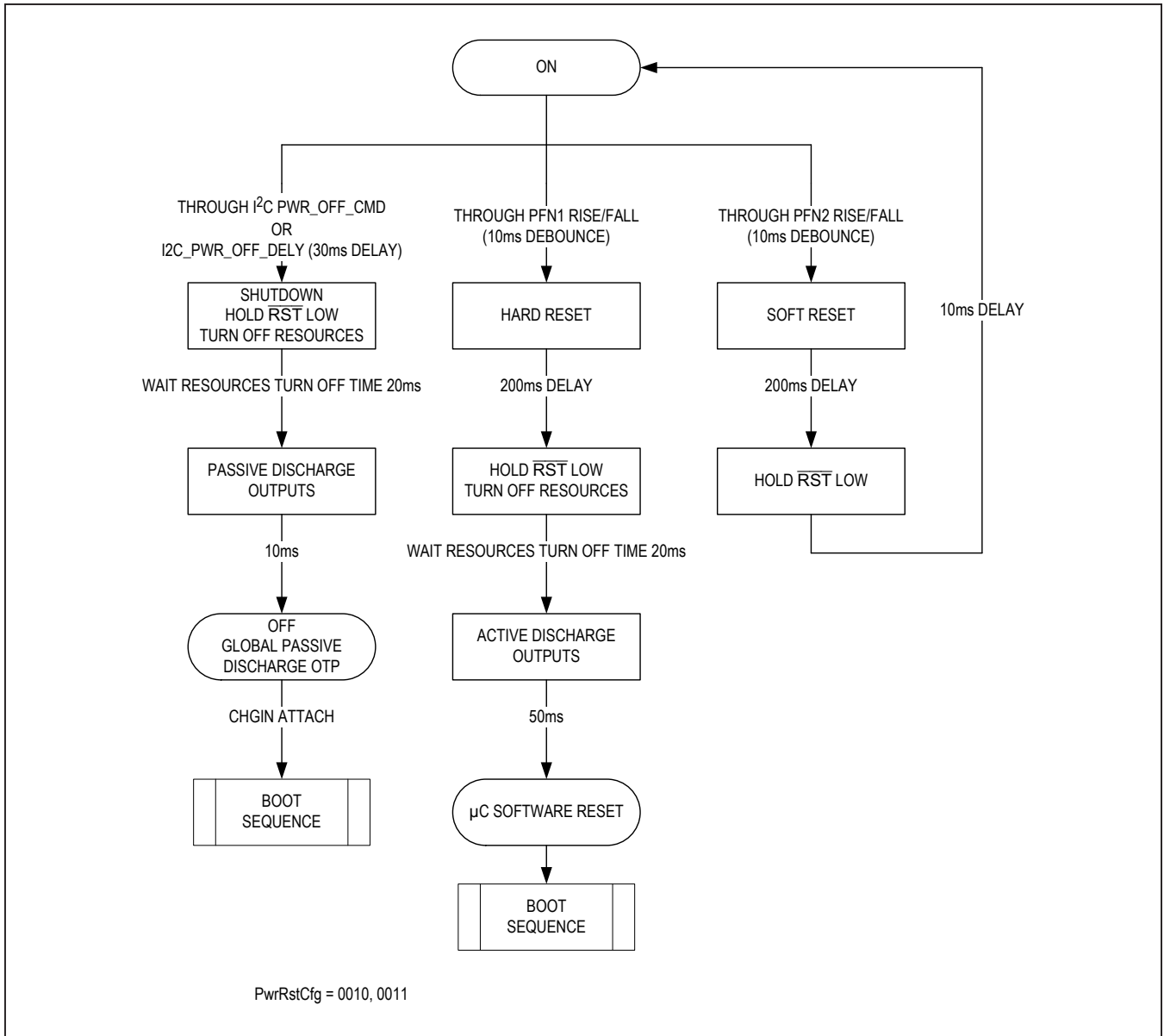

Figure 1b. PwrRstCfg = 0010 or 0011

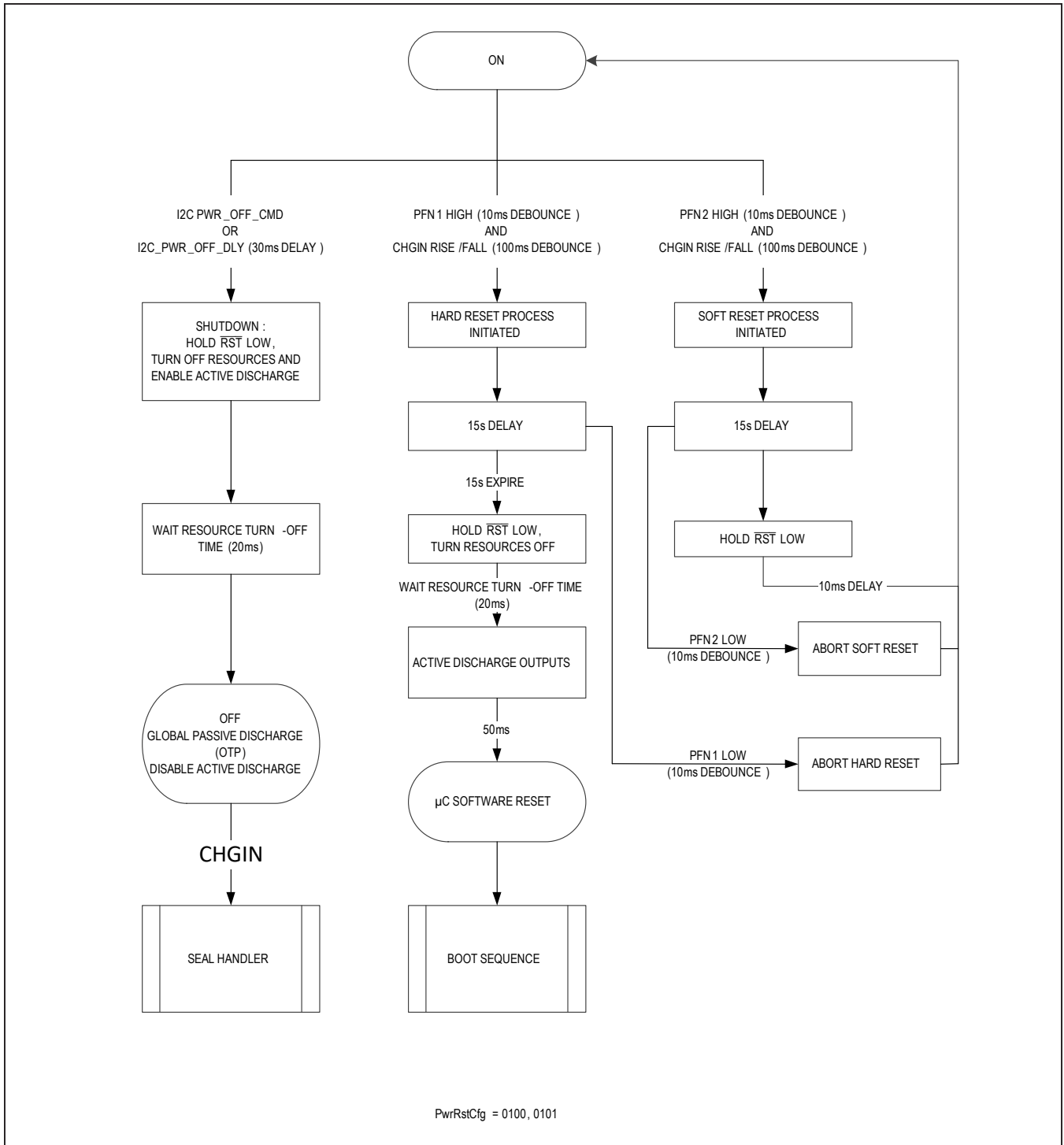

Figure 1c. PwrRstCfg = 0100 or 0101

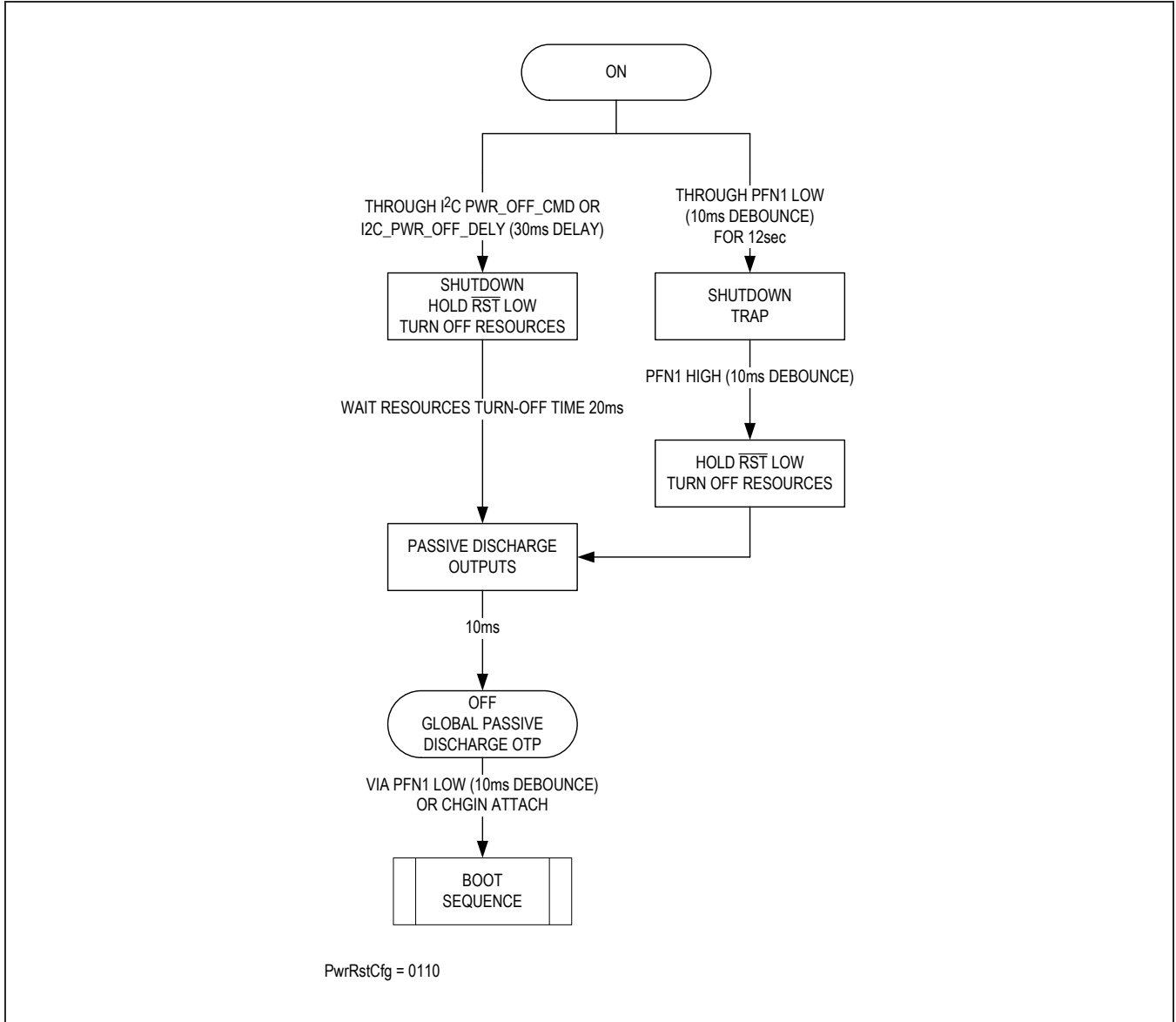

Figure 1d. PwrRstCfg = 0110



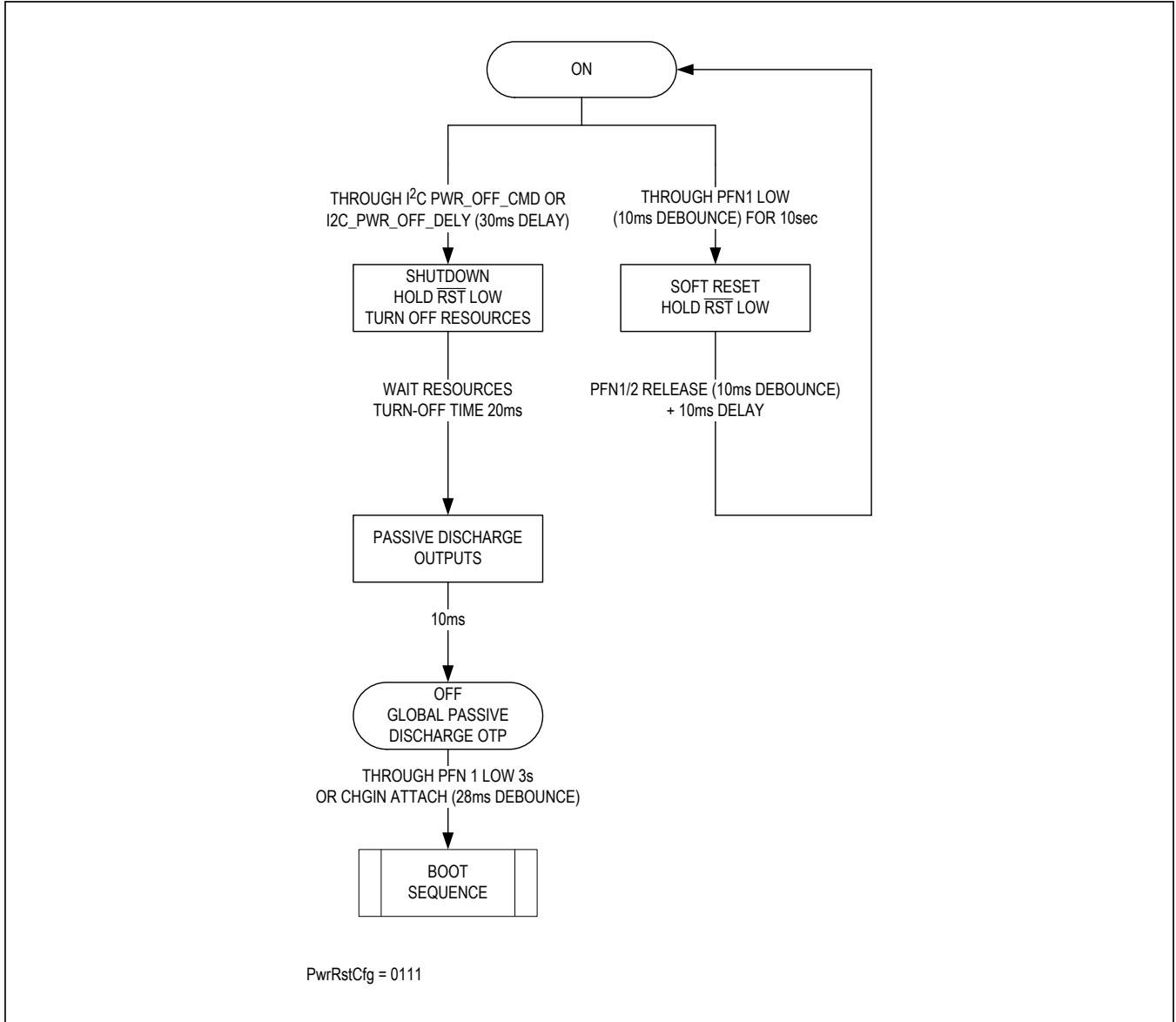

Figure 1e. PwrRstCfg = 0111

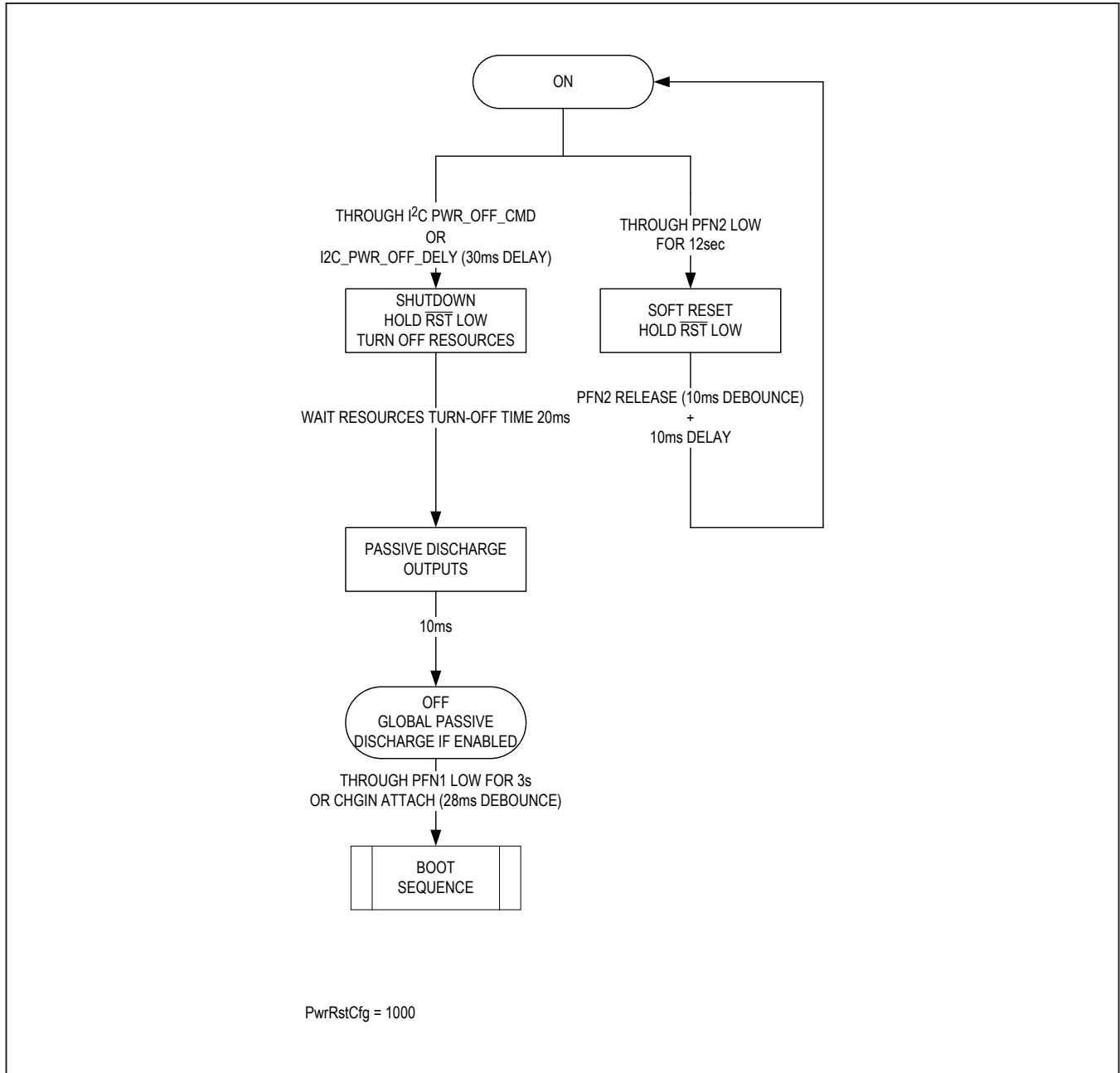

Figure 1f. PwrRstCfg = 1000

Table 2. PwrRstCfg Settings

| PwrRstCfg | PFN1   | PFN1 PU/PD* | PFN2   | PFN2 PU/PD* | Notes   |
|-----------|--|-------------|--|-------------|---|
| 0000      | Enable   | Pulldown    | Soft-Reset<br>Active-Low                                       | Pullup      | On/Off mode with 10ms debounce. Active-high On/Off control on PFN1. Logic-low on PFN2 generates 10ms pulse on $\overline{RST}$ .<br><b>Note:</b> In this mode, if PFN1 is high, PWR_OFF_CMD will cause the part to turn off, then immediately return to the ON state. |
| 0001      | Disable  | Pullup      | Soft-Reset<br>Active-Low                                       | Pullup      | On/Off mode with 10ms debounce. Active-low On/Off control on PFN1. Logic-low on PFN2 generates 10ms pulse on $\overline{RST}$ .<br><b>Note:</b> In this mode, if PFN1 is high, PWR_OFF_CMD will cause the part to turn off, then immediately return to the ON state.  |
| 0010      | Hard-Reset<br>Active-High                                    | Pulldown    | Soft-Reset<br>Active-High                                      | Pulldown    | Always-On mode (i.e., device can only be put in Off state through PWR_OFF_CMD). 10ms hard reset off time. 10ms soft reset pulse time. 200ms delay prior to both reset behaviors.  |
| 0011      | Hard-Reset<br>Active-Low                                     | Pullup      | Soft-Reset<br>Active-Low                                       | Pullup      | Always-On mode (i.e., device can only be put in Off state through PWR_OFF_CMD). 50ms Hard-Reset off time. 10ms Soft-Reset pulse time. 200ms delay prior to both reset behaviors.  |
| 0100      | Hard-Reset<br>Active-High<br>Triggered on<br>CHGIN Insertion | Pulldown    | Soft-Reset<br>Active-High Trig-<br>gered on CHGIN<br>Insertion | Pulldown    | Always-On mode (i.e., device can only be put in Off state through PWR_OFF_CMD). 50ms Hard-Reset off time. 10ms Soft-Reset pulse time. 15s delay prior to both reset behaviors. Either reset may be aborted  |
| 0101      | Hard-Reset<br>Active-Low<br>Triggered by<br>CHGIN Insertion  | Pullup      | Soft-Reset<br>Active-Low Trig-<br>gered on CHGIN<br>Insertion  | Pullup      | Always-On mode (i.e., device can only be put in Off state through PWR_OFF_CMD). 70ms Hard-Reset off time. 10ms Soft-Reset pulse time. 15s delay prior to both reset behaviors. Either reset may be aborted.   |
| 0110      | $\overline{KIN}$   | Pullup      | $\overline{KOUT}$  | None        | Off mode through specific long-press (12s) or PWR_OFF_CMD. On mode through specific short-press (400ms).  |
| 0111      | $\overline{KIN}$   | Pullup      | $\overline{KOUT}$  | None        | Off mode through PWR_OFF_CMD. On mode through specific long-press (3s) or CHGIN insertion soft reset through specific long press (10s).   |
| 1000      | $\overline{KIN}$   | Pullup      | Soft-Reset<br>Active-Low 12s<br>Long Press                     | Pullup      | Custom Two Button. Off mode through PWR_OFF_CMD. On mode through $\overline{KIN}$ long-press (3s) or CHGIN insertion. Soft reset through PFN2 long press (12s).   |
| 1001-1111 | RFU  |             |  |             |   |

\*Note: The presence of internal pullup/pulldown resistors on PFN1 and PFN2 is device specific. Refer to [Table 202](#) to determine if a device has internal resistors or requires external resistors.

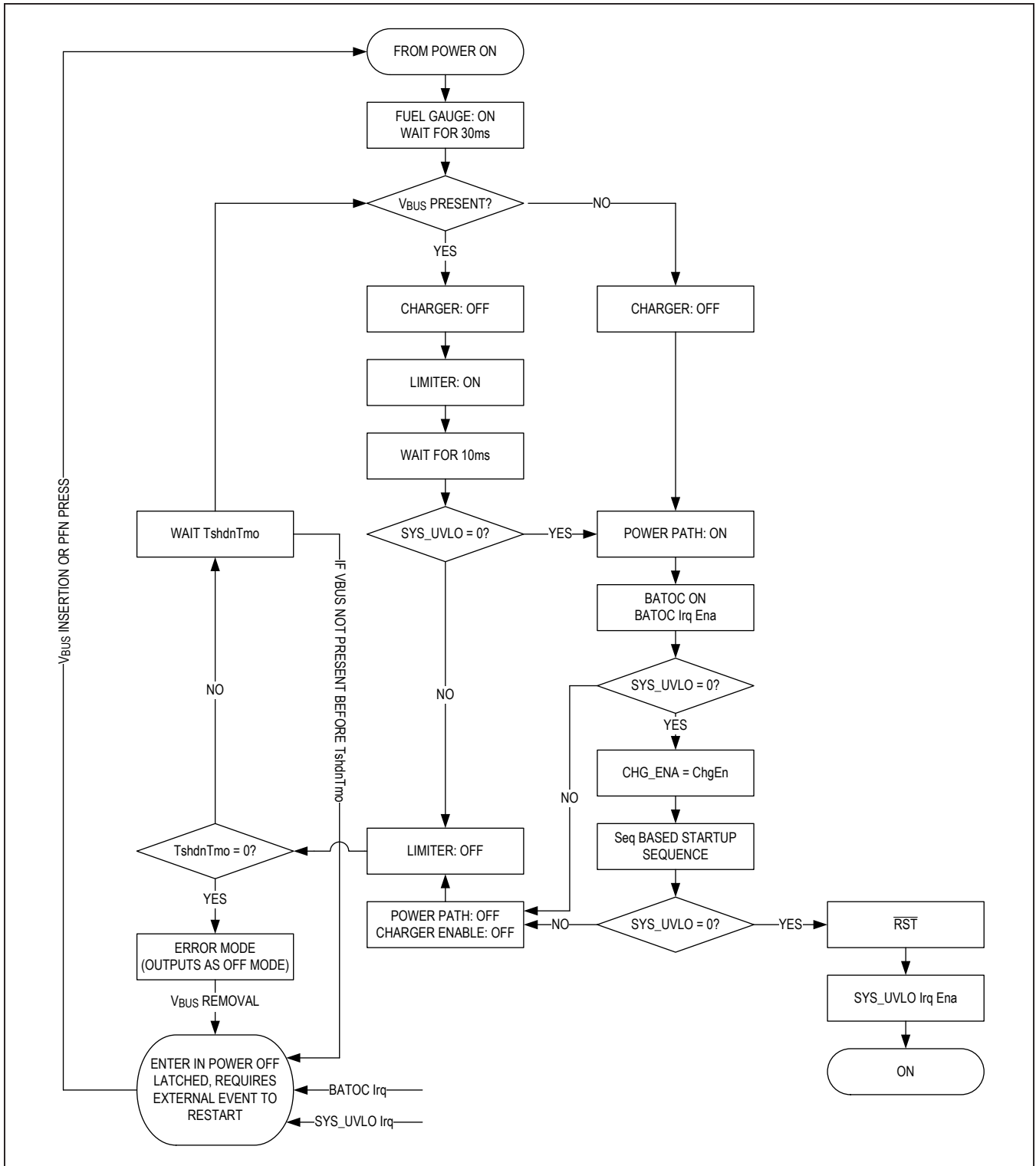

Figure 2. The full MAX20353 Boot Sequence

**Power Sequencing**

The sequencing of the switching regulators, LDOs, and charge pump during power-on is configurable. See each regulator’s sequencing bits for details. Regulators can turn on at one of three points during the power-on process: 75ms after the power-on event, at the time the  $\overline{RST}$  signal is released, or at two points in between. The two points between SYS and  $\overline{RST}$  are fixed proportionally to the duration of the Power-On Reset (POR) process ( $t_{RST}$ ). The timing relationship is presented graphically in Figure 3.

Alternatively, the regulators can remain off by default and turn on with an I<sup>2</sup>C command after  $\overline{RST}$  is released.

LDO2 can be configured to be always-on as long as SYS or BAT is present.

The SYS voltage is monitored during the power-on sequence. If  $V_{SYS}$  falls below  $V_{SYS\_UVLO\_F}$  during the sequencing process with a valid voltage at CHGIN, the process repeats from the point where SYS was enabled to allow more time for the voltage to stabilize. If there is not a valid voltage at CHGIN, the device returns to the OFF state to avoid draining the battery. Power is also turned off if BAT experiences a current greater than  $I_{BAT\_OC\_R}$  for more than  $t_{BAT\_OC\_D}$ .

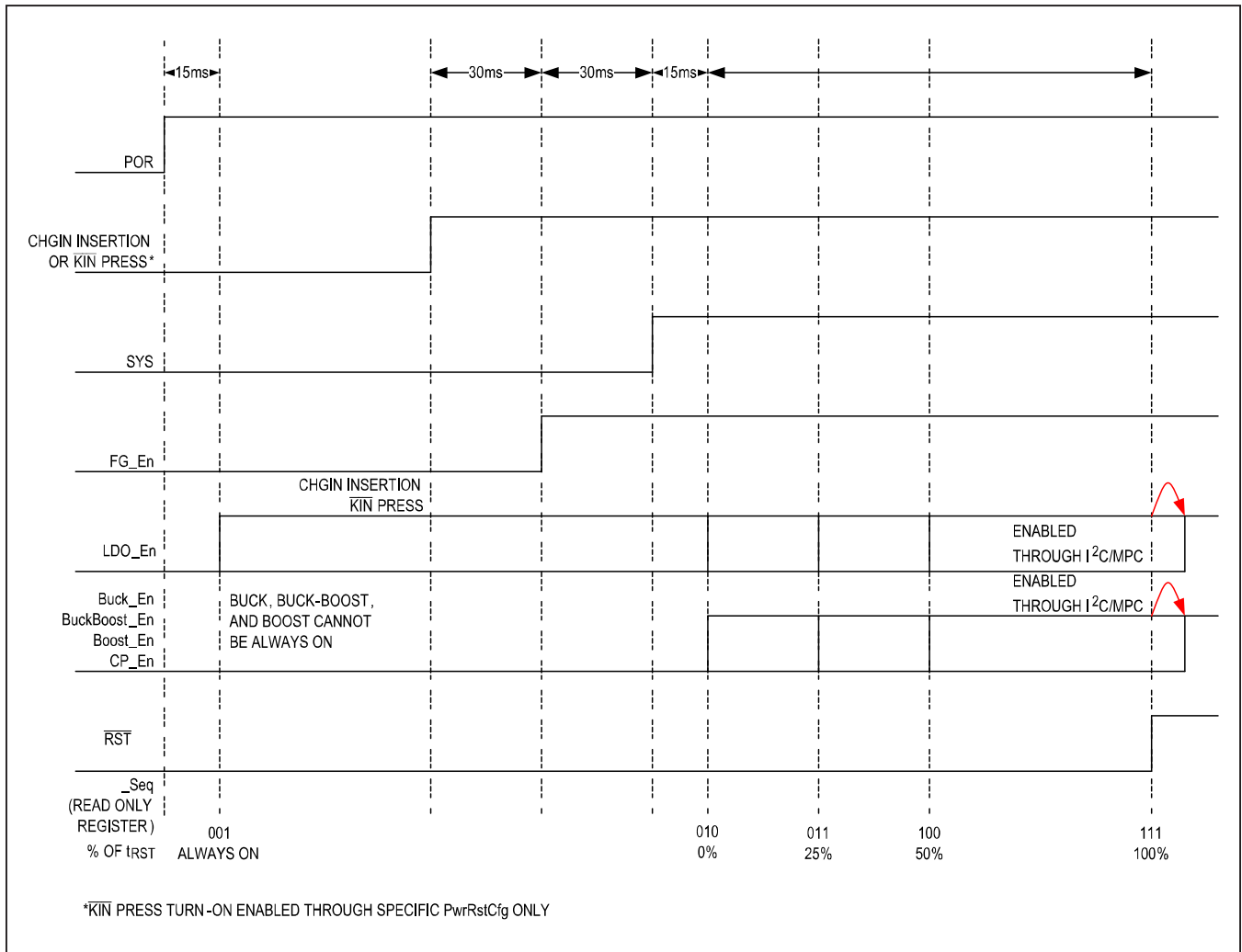

Figure 3. Reset Sequence Programming

### Current Sink

In addition to several voltage regulators, the MAX20353 also includes three low-dropout linear current regulators from LED\_ to GND. The sink current of each current regulator is independently programmable through its respective LED\_ISet[4:0] bits in direct registers LED\_Direct (0x2D–0x2F). The current regulators can be programmed to sink 0.6mA to 30mA with configurable step sizes and are ideal for sinking current from external LEDs. The LEDStep[1:0] bits in direct register LEDStepDirect (0x2C) control the size of the current steps for all current sinks. This step size also sets an effective limit on the sinking current as the number of steps remains constant while the step size varies. Current sinks are enabled through an I<sup>2</sup>C command, by an internal charger status signal, or by an external MPC pin allowing for LED status indicators. Note that the current sinks always draw quiescent current when tied to an MPC\_ control or status signal regardless of the MPC\_ or status state.

### System Load Switch

An internal 80mΩ (typ) MOSFET connects BAT to SYS when no voltage source is available on CHGIN. When an external source is detected at CHGIN, this switch opens and SYS is powered from the input source through the input current limiter. The SYS-to-BAT switch also prevents V<sub>SYS</sub> from falling below V<sub>BAT</sub> when the system load exceeds the input current limit. If V<sub>SYS</sub> drops to V<sub>BAT</sub> due to the current limit, the BAT-SYS switch turns on so the load is supported by the battery. If the system load continuously exceeds the input current limit, the battery is not charged. This is useful for handling loads that are nominally below the input current limit but have high current peaks exceeding the input current limit. During these peaks, battery energy is used, but at all other times the battery charges.

### Smart Power Selector

The smart power selector seamlessly distributes power from the external CHGIN input to the BAT and SYS nodes. With both an external adapter and battery connected, the smart power selector basic functions are:

- When the system load requirements are less than the input current limit, the battery is charged with residual power from the input.
- When the system load requirements exceed the input current limit, the battery supplies supplemental current to the load.
- When the battery is connected and there is no external power input, the system is powered from the battery.

### Input Limiter

The input limiter distributes power from the external adapter to the system load and battery charger. In addition to the input limiter's primary function of passing power to the system load and charger, it performs several additional functions to optimize use of available power.

**Invalid CHGIN Voltage Protection:** If CHGIN is above the overvoltage threshold, the device enters overvoltage lockout (OVL). OVL protects the MAX20353 and downstream circuitry from high-voltage stress up to +28V and down to -5.5V. During positive OVL, the internal circuit remains powered and an interrupt is sent to the host. The negative voltage protection disconnects CHGIN and the device is powered only by BAT. The charger turns off and the system load switch closes, allowing the battery to power SYS. CHGIN is also invalid if it is less than V<sub>BAT</sub>, or less than the USB undervoltage threshold. With an invalid input voltage, the BAT-SYS load switch closes and allows the battery to power SYS.

**CHGIN Input Current Limit:** The CHGIN input current is limited to prevent input overload. The input current limit is controlled by I<sup>2</sup>C. To accommodate systems with a high in-rush current, the limiter includes a programmable blanking time during which the input current limit increases to I<sub>LIM\_MAX</sub>.

**Thermal Limiting:** In case the die temperature exceeds the normal limit (T<sub>CHG\_LIM</sub>), the MAX20353 attempts to limit temperature increase by reducing the input current from CHGIN. In this condition, the system load has priority over the charger current, so the input current is first reduced by lowering the charge current. If the junction temperature continues to rise and reaches the maximum operating limit (T<sub>CHGIN\_SHDN</sub>), no input current is drawn from CHGIN and the battery powers the entire system load.

**Adaptive Battery Charging:** While the system is powered from CHGIN, the charger draws power from SYS to charge the battery. If the total load exceeds the input current limit, an adaptive charger control loop reduces charge current to prevent V<sub>SYS</sub> from collapsing. When the charge current is reduced below 50% due to I<sub>LIM</sub> or T<sub>CHG\_LIM</sub> limits, the timer clock operates at half speed. When the charge current is reduced below 20% due to I<sub>LIM</sub> or T<sub>CHG\_LIM</sub> limits, the timer clock is paused.

**Fast-Charge Current Setting:** The MAX20353 uses an external resistor connected from SET to GND to set the fast-charge current. The precharge and charge-termination currents are programmed as a percentage of this value by opcode 0x14. The fast-charge current resistor can be calculated as:

$$R_{SET} = K_{SET} \times V_{SET} / I_{FChg}$$

where  $K_{SET}$  has a typical value of 2000A/A and  $V_{SET}$  has a typical value of +1V. The range of acceptable resistors for  $R_{SET}$  is 4kΩ to 400kΩ.

A capacitive load on SET can cause instability of the charger if the condition  $(C_{SET} < 5\mu s/R_{SET})$  pF is violated.

**SAR ADC/Monitor MUX**

In order to simplify system monitoring, the MAX20353 includes a voltage monitor multiplexer (MUX). The I<sup>2</sup>C controlled MUX connects the MON pin to the scaled value of one of six voltage regulators, BAT, or SYS. A resistive divider scales the voltage to one of four ratios determined by MONRatioCfg[1:0] (opcode 0x50, Table 124). Because the MUX can only tolerate voltages up to +5.5V,  $V_{CHGIN}$ ,  $V_{CPOUT}$ , and  $V_{BSTOUT}$  are not available to MON.

An internal ADC reads the remaining voltage rails and performs system tasks such as JEITA temperature monitoring and SYS tracking during haptic driver operations. Manual ADC measurements are initiated by writing the desired channel to ADC\_Measure\_Launch (opcode 0x53, Table 128) and reading the response from APDataIn0-3. The ADC can also measure the MON voltage when the MUX is enabled with a 1:1 ratio. The full-scale range of the ADC for different voltage rails is detailed in Table 3.

**JEITA Monitoring with Charger Control**

To enhance safety when charging Li+ batteries, the MAX20353 includes JEITA-compliant temperature monitoring. A resistive divider is formed on THM by attaching a pullup resistor to TPU and connecting the thermistor of a battery-pack (do not exceed 1mA load on TPU). The divider output is read by the internal ADC when JEITA monitoring is enabled and the resulting temperature measurement places the battery into one of five temperature zones: cold, cool, room, warm, and hot. Zone-specific temperature limits and charging behavior are

**Table 3. SAR ADC Full-Scale Voltages and Conversions**

| VOLTAGE RAIL | AVAILABLE RANGE      | CONVERSION (V)           |
|--------------|----------------------|--------------------------|
| SYS          | +2.6V to +5.5V       | (Result[7:0] * 5.5)/255  |
| MON          | 0V to +5.5V          | (Result[7:0] * 5.5)/255  |
| THM          | 0% to 100% $V_{DIG}$ | (Result[7:0] * 100)/255  |
| CHGIN        | +3V to +8V           | (Result[7:0] * 8.25)/255 |
| CPOUT        | +3V to +8V           | (Result[7:0] * 8.25)/255 |
| BSTOUT       | +3V to +21V          | (Result[7:0] * 21.0)/255 |

fully configurable through the ChargerThermalLimits\_Config\_Write (opcode 0x16, Table 76) and ChargerThermalReg\_Config\_Write (opcode 0x18, Table 80) commands detailed in Table 76 and Table 80. Some example profiles are included in Figure 4. It is important to note that, because battery temperature is measured by the internal ADC, JEITA monitoring is unavailable when automatic level compensation is enabled in the haptic driver.

**Haptic Driver**

**Note:** The haptic driver registers must be updated to to the recommended default values shown in Table 199 and Table 200. Failure to overwrite the default values after a POR results in poor haptic driver performance.

The MAX20353 features a versatile, integrated haptic driver. The driver allows for real time control of haptic devices through PWM or I<sup>2</sup>C as well as the ability to run haptic patterns from internal RAM. For added flexibility, the driver is capable of driving both Linear Resonant Actuator (LRA) and Eccentric Rotating Mass (ERM) actuators.

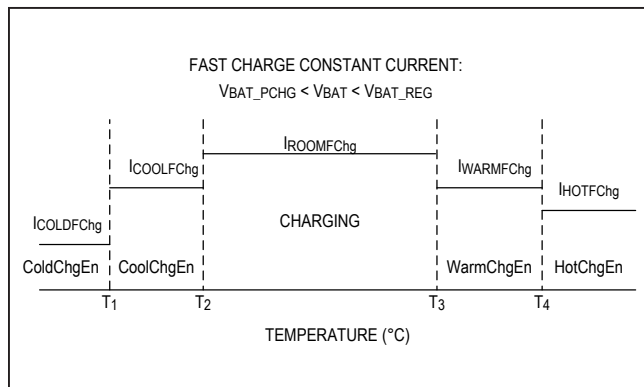

Figure 4a. Sample JEITA Pre Charge Profile

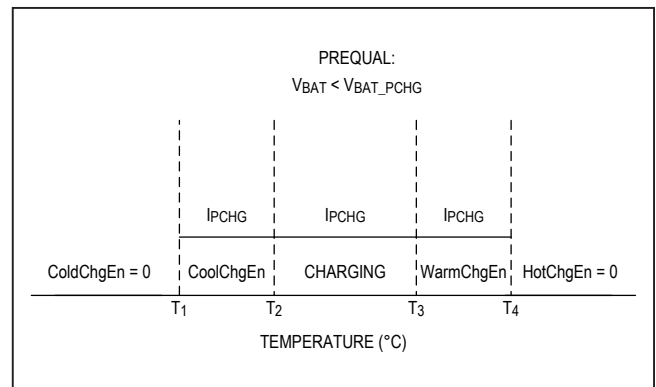

Figure 4b. Sample JEITA Fast Charge Profile

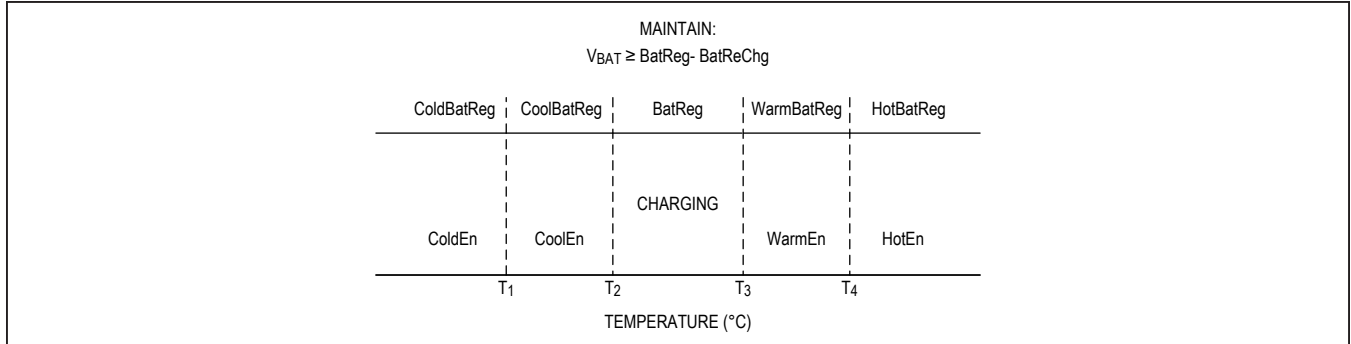

Figure 4c. Sample JEITA Maintain Charge Profile

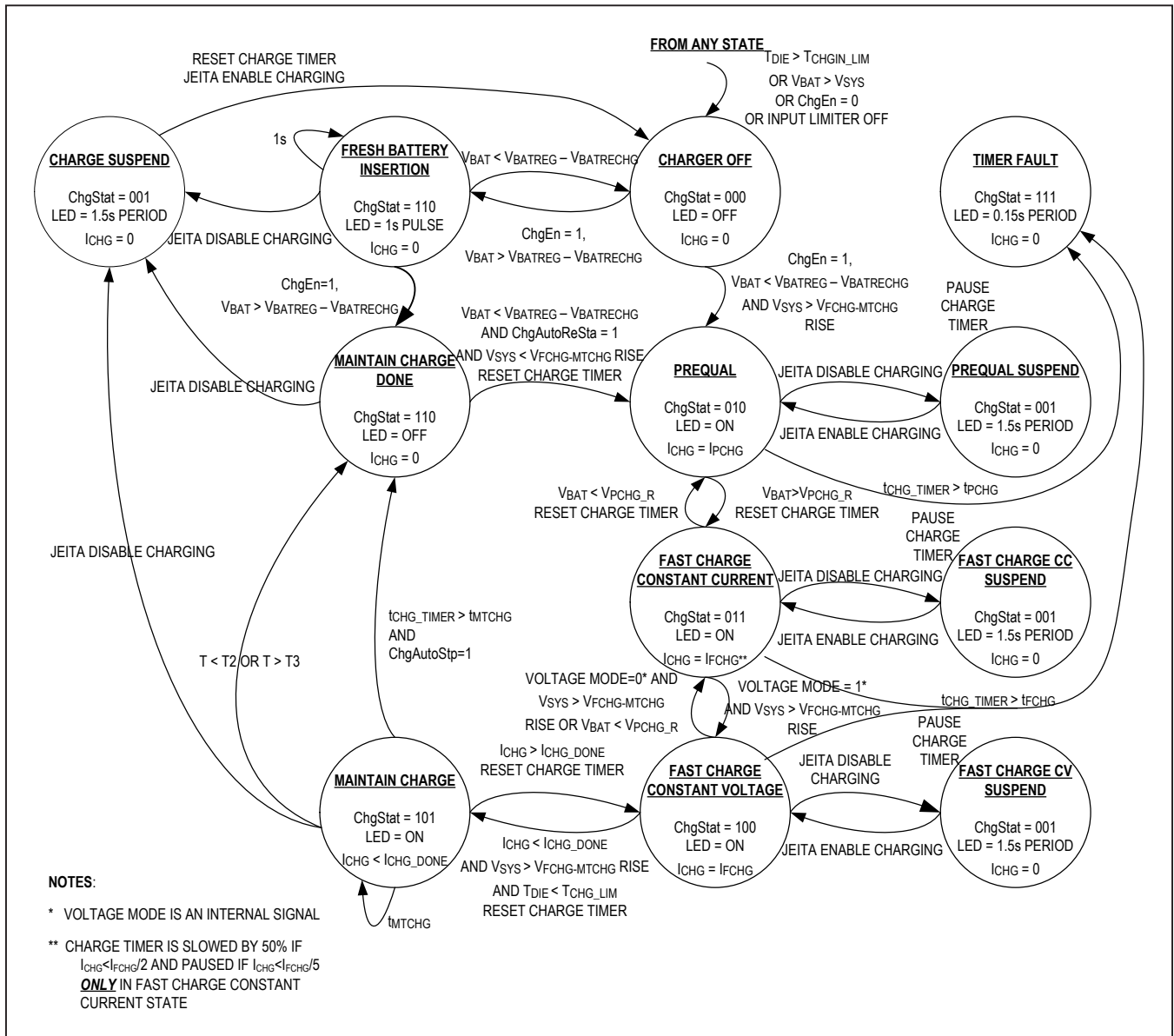

Figure 5. Charger State Diagram



**ERM**

An ERM is the simplest haptic actuator to drive. The driving signal is taken directly as the output of an integrated H-bridge, allowing for bidirectional operation of the actuator. To configure the MAX20353 to drive an ERM, the HptSel bit must be set to 0 using the opcode 0xA0 or 0xAD ([Table 134](#) or [Table 160](#)).

**LRA**

Unlike the on-off control of an ERM, LRAs require a sinusoidal driving signal. The MAX20353 realizes this with a Class-D amplifier that converts the driver input to a sinusoidal output.

An LRA's vibration magnitude is maximized when the driving signal matches the LRA's resonant frequency. To ensure the haptic driver closely tracks this frequency, the MAX20353 includes an auto-resonance tracking feature that measures the back-electromotive force (BEMF) of the LRA and modulates the drive frequency to minimize the phase error between the BEMF and the driving signal. The resonant tracking feature should remain enabled any time an LRA is driven. Resonance tracking is enabled by setting the EmfEn bit to 1 with opcode 0xA0 or 0xAD. The range of resonant frequencies that are tracked is clamped by the driver to be no lower than  $\max(200k/IniGss[11:0], 100)$  Hz and no greater than  $\min(800k/IniGss[11:0], 500)$  Hz. See description of IniGss[11:0] in [Table 134](#) for calculation of frequency. This mitigates the risk of audible noise during a fault event.

To select LRA mode, set the HptSel bit to 1 using opcode 0xA0 or 0xAD.

**LRA Braking**

The haptic driver features enhanced BEMF tracking and automatic braking to efficiently stop or reverse the direction of an LRA. Each time the driving polarity is reversed, the BEMF measurement configurations are overridden by the values in BrkLpGain[1:0] (opcode 0xB0), BrkCyc[4:0] (opcode 0xB1), and BrkWdw[4:0] (opcode 0xB9) for BrkCyc[4:0] number of half cycles. This allows the haptic driver to optimize the redetection of the BEMF after the sudden change in direction.

Additionally, the haptic driver can automatically detect the optimal braking time when running patterns in the RAMHP and ETRG modes. When the RAM pattern reaches a brake sample ( $nLSx[1:0] = 00$  and  $RPTx[3:0] = 0000$ ), or when the ETRG pattern reaches the brake amplitude, the haptic driver measures the LRA's BEMF amplitude. The BEMF amplitude measurements are taken at either two or four sample points along the sine wave depending on AutoBrkPeakMeas setting in register 0x26. If the absolute value of the BEMF is lower than the threshold

AutoBrkMeasTh[1:0] (register 0x27) for more than half of the duration of AutoBrkMeasWdw[3:0] (register 0x27) over a number of consecutive sample points (set by AutoBrkMeasEnd[1:0], register 0x27), then the driver determines that the BEMF is sufficiently small and driving stops. Recommended braking settings are provided in [Table 199](#) and [Table 200](#).

**Driver Amplitude**

The haptic driver features a configurable voltage basis for the amplitude of the driving signal. Setting this basis, referred to as the full-scale voltage ( $V_{FS}$ ), configures the maximum amplitude of the driver output. It is set using HptVfs[7:0] with opcode 0xA2 or 0xB2 ([Table 138](#) or [Table 170](#)) and has a range of 0V to 5.5V ( $LSB = 21.57mV$ ). Since the H-bridge is supplied by  $V_{SYS}$ , the actual full-scale voltage of the driver at any given moment is the minimum of the value stored in HptVfs[7:0] and  $V_{SYS}$ .

Once  $V_{FS}$  has been set, all driver amplitudes are scaled as a percentage of the full-scale voltage. The resolution of the amplitude is always  $V_{SYS}/128$ . Therefore, the effective resolution of the amplitude scales with the  $V_{FS}/V_{SYS}$  ratio. For example, if  $V_{FS} = V_{SYS}/2$ , the effective resolution is 6 bits.

**Automatic Level Compensation**

Because  $V_{SYS}$  can vary over time, the driver must adjust its output duty cycle to maintain a constant reference to the full-scale voltage. An Automatic Level Compensation (ALC) function measures  $V_{SYS}$  and handles this adjustment. ALC can be enabled by setting the AlcMod bit to 1 using opcode 0xA0 or 0xAD and uses the MAX20353's internal ADC to monitor  $V_{SYS}$ . The ALC function then scales the haptic driver's duty cycle as needed to maintain the programmed driver amplitude. If ALC is not enabled,  $V_{SYS}$  is assumed to be  $V_{FS}$ .

**Haptic UVLO**

Additionally,  $V_{SYS}$  is measured after the driver is enabled but prior to starting a vibration. At any moment, if  $V_{SYS}$  goes below the programmed UVLO value, which is set through HptSysUVLO[7:0] with opcode 0xA6 ([Table 146](#)), the vibration event is aborted and the haptic driver is locked. See the [Haptic Driver Lock](#) section for details regarding restarting vibration if a haptic UVLO condition is reached.

The time required to perform the  $V_{SYS}$  measurement, as well as other startup delays, results in an initial latency of the haptic driver. To avoid partial pattern skipping in real-time modes, vibration patterns should be provided at least  $t_{HD\_START}$  after enabling the desired real-time vibration mode (PPWM or RTI<sup>2</sup>C).

### Vibration Timeout

A vibration timeout parameter is programmable through I<sup>2</sup>C. If a vibration lasts longer than the programmed timeout period, the vibration is aborted. The timeout period is stored in HptDrvTmo[5:0] (LSB = 1s), which can be written using opcode 0xB7 (Table 180). Writing code “000000” disables the timeout function. See the [Haptic Driver Lock](#) section for details regarding restarting vibration if a timeout is reached.

### Overcurrent/Thermal Protection

The haptic driver also includes overcurrent and thermal shutdown protection. While the haptic driver is active, the MAX20353 monitors the current from DRP and DRN. If overcurrent protection is enabled (HptOCProtDis = 0) and the DRP or DRN current exceeds I<sub>HD\_OC\_THR</sub>, the haptic driver issues a fault, aborts vibration, and enters the locked state.

Thermal protection allows the MAX20353 to immediately shut down the haptic driver should the die temperature exceed T<sub>HD\_OC\_THR</sub>. This feature is enabled by setting HptThmProtDis = 0.

See the [Haptic Driver Lock](#) section for details regarding restarting vibration if an overcurrent or overtemperature condition is reached.

### Haptic Driver Lock

If the MAX20353 detects a fault in the haptic driver, vibrations in progress are aborted and the haptic driver is locked by the HptLock bit. The user must manually clear the HptLock bit using opcode 0xA8 (Table 150) in order to run a new vibration attempt. A fault occurs under any of the following conditions: V<sub>SYS</sub> drops below the threshold programmed in HptSysUVLO[7:0] (SystemError 0x25), an overcurrent is detected on DRN or DRP (SystemError = 0x20, 0x21, 0x22, or 0x23), the die temperature exceeds the thermal protection threshold (SystemError = 0x24), or a vibration duration exceeds the timeout period stored in HptDrvTmo[5:0] (SystemError 0x04). Writing any value other than 0x00 with opcode 0xA8 will set HptLock high and disable the driver output.

### Interface Modes

There are a total of four interface modes for controlling the haptic driver. These include two real-time modes and two stored memory modes. The haptic driver mode is set through HptDrvMode[4:0] with the direct-access I<sup>2</sup>C register 0x31. Selecting an operation mode also enables the driver. In addition, HptDrvEn must be set and kept to 1 before setting HptDrvMode[4:0] and for the whole duration of vibration. Once vibration finishes, HptDrvMode[4:0] must be set to “00000” before the haptic driver may be disabled via HptDrvEn = 0 for power savings.

### Pure-PWM (PPWM)

PPWM mode offers real-time control of the haptic driver. Patterns are generated by applying a PWM signal to the MPC<sub>\_</sub> pin selected by HptDrvMode[4:0]. The duty cycle of the applied signal determines the amplitude of the driving signal, scaled by V<sub>FS</sub>. The driving direction is centered about a 50% duty cycle. A duty cycle of 0% to 47.5% produces a (100 to 0)%V<sub>FS</sub> amplitude in the negative direction and a duty cycle of 52.5% to 100% produces a (0 to 100)%V<sub>FS</sub> amplitude in the positive direction. The region between 47.5% and 52.5% duty cycle is a dead zone and inputs within this range correspond to a null output.

A timeout feature prevents idle PWM inputs from causing unwanted vibrations of the haptic motor. If the input signal remains at 0% duty cycle or 100% duty cycle for more than 2.56ms, the output is null and vibration stops. As such, the MPC<sub>\_</sub> input must remain dynamic to produce a continuous output.

### Real-Time I<sup>2</sup>C (RTI<sup>2</sup>C)

Similar to PPWM mode, RTI<sup>2</sup>C mode offers real-time control of the haptic driver. The direct register HptRTI2CAmp (0x32) determines the amplitude of the output signal. The lower seven bits of the register (HptRTI2CAmp[6:0]) set the amplitude as a percentage of V<sub>FS</sub> and the MSB (HptRTI2CSign) sets the direction of rotation. 100% amplitude, reverse drive, for example, is produced by setting HptRTI2CAmp to 0x7F (0b01111111).

Once RTI<sup>2</sup>C mode is enabled through HptDrvMode[4:0], the haptic driver continuously outputs the amplitude and direction defined by the latest data in HptRTI2CAmp. In order to generate haptic patterns, the HptRTI2CAmp register must receive new data.

### External Triggered Stored Pattern (ETRG)

In ETRG mode, a rising edge on an MPC<sub>\_</sub> pin or a 0-to-1 transition of the HptExtTrig bit in direct I<sup>2</sup>C register 0x31 initiates a vibration sequence. The sequence is contained in six registers and comprises an overdrive (startup) amplitude, active drive amplitude, braking amplitude, and the duration of each driving behavior.

Amplitudes contained in ETRGOdAmp[7:0], ETRGActAmp[7:0], and ETRGBrkAmp[7:0], which are set through opcode 0xA2–0xA4 or 0xB3 (Table 138 thru Table 143 and Table 172), follow the same format as HptRTI2CSign + HptRTI2CAmp[6:0] in direct I<sup>2</sup>C register 0x32 (i.e., the lower-seven bits store the amplitude as a percentage of V<sub>FS</sub> and the MSB determines the direction).

The trigger input is selected when the driver enters ETRG mode via HptDrvMode[4:0] in direct I<sup>2</sup>C register 0x31. In order to properly register the rising edge, the trigger signal must remain high for a few clock cycles of the driver.

Once the sequence begins, the haptic driver follows the duration values stored in ETRGOdDur[7:0], ETRGActDur[7:0], and ETRGBrkDur[7:0]. It is possible, however, to extend the active drive time by leaving the trigger high longer than the time specified in ETRGActDur[7:0]. Doing so will cause the driver to output the amplitude stored in ETRGActAmp[7:0] until a falling edge is detected. Once the trigger signal falls low, the brake sequence executes.

**RAM Stored Haptic Pattern (RAMHP)**

The final method of controlling the haptic driver is RAMHP mode. The MAX20353 contains an internal 256 x 24 bit RAM in which haptic patterns are stored. By storing haptic sequences in RAM at startup, the driver can perform sophisticated haptic sequences upon receipt of a trigger signal as in ETRG mode. The direct I2C register HptPatRAMAddr (0x33) specifies the RAM address where the sequence begins.

RAM should be loaded when the MAX20353 comes out of Off mode. To write data to the RAM, the HptRAMEN bit in direct register HptDirect1 (0x31) must first be set high. Next, writing a value to the direct register HptRAMAddr (0x28) specifies the RAM address in which data written

to HptDataH, HptDataM, and HptDataL (0x29, 0x2A, and 0x2B, respectively) is stored. It is possible to read back data from RAM. Writing an address to HptRAMAddr, then initiating an I2C read transaction of register 0x29, will allow readback of the three bytes stored in the RAM address. RAM read and write procedures are depicted graphically in Figure 6.

A haptic pattern is composed of multiple pattern samples. Pattern samples define the amplitude, duration, wait time, transition, and repetition of a segment of a haptic pattern. These samples are defined in three bytes and written to RAM through HptDataH, HptDataM, and HptDataL. HptDataH contains the sign of the sample's amplitude (AxSign), the upper-five bits of the amplitude (Ax[6:2]), and instructions to the haptic driver on handling the pattern sample (nLSx). HptDataM contains the lower two bits of the sample's amplitude (Ax[1:0]), the duration of the sample (Dx), and the upper bit of the wait time before the next sample in the pattern (Wx[4]). HptDataL contains the lower four bits of the wait time (Wx[3:0]) and the repetition behavior (RPTx). Table 4 describes the definition of a pattern sample and Figure 7 provides a sample haptic pattern with corresponding waveform.

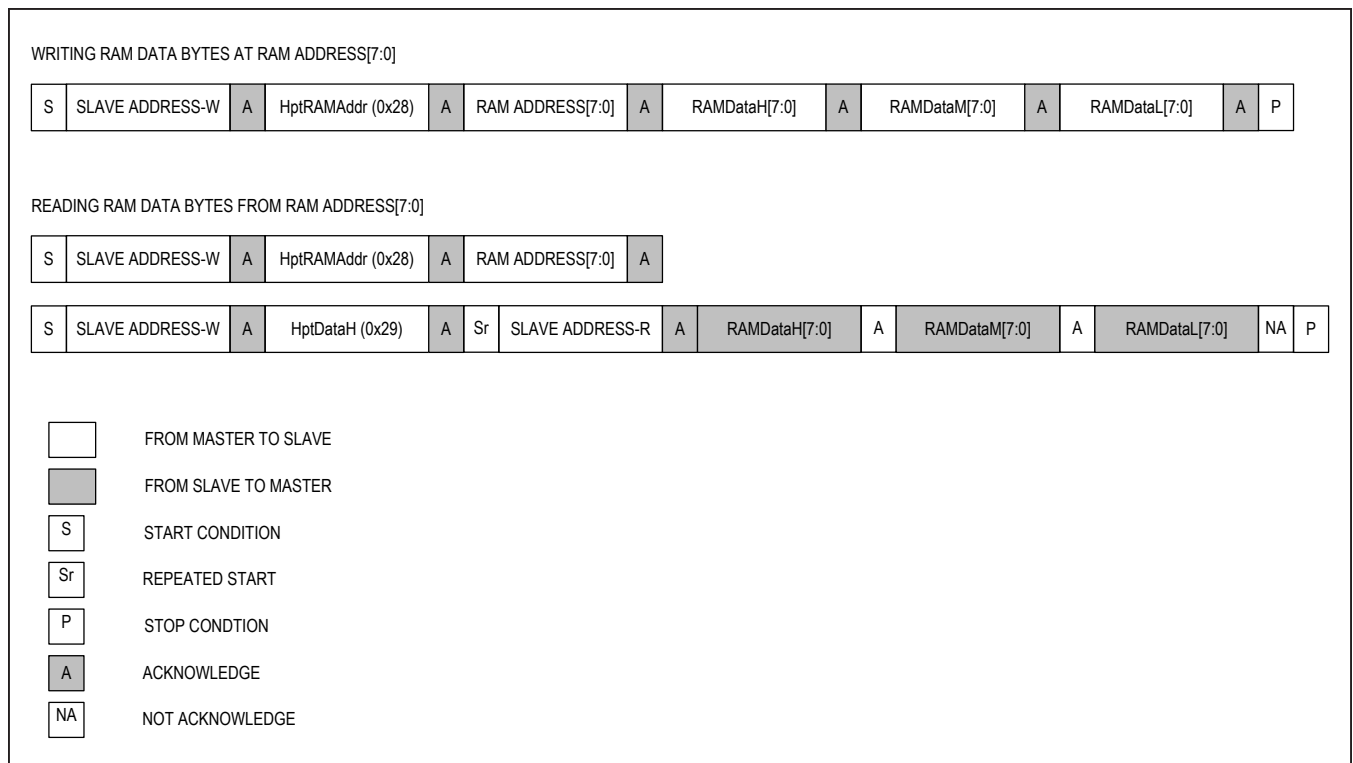

Figure 6. Read and Write Processes for RAM

**Table 4. RAMHP Pattern Storage Format**

| ADDRESS          | 0x28-0x2B   |    |          |          |           |    |         |    |
|------------------|---|----|----------|----------|-----------|----|---------|----|
| BIT              | B7  | B6 | B5       | B4       | B3        | B2 | B1      | B0 |
| HptRAMAddr       | HptRAMAddr[7:0]   |    |          |          |           |    |         |    |
| HptDataH         | nLSx[1:0]   |    | AmpSign  | Amp[6:2] |           |    |         |    |
| HptDataM         | Amp[1:0]  |    | Dur[4:0] |          |           |    | Wait[4] |    |
| HptDataL         | Wait[3:0]   |    |          |          | RPTx[3:0] |    |         |    |
| HptRAMAddr [7:0] | The RAM address in which the pattern sample is stored   |    |          |          |           |    |         |    |
| nLSx[1:0]        | Sets the behavior of a sample in the pattern.<br>00 = Current sample is the last sample in the pattern<br>01 = Current sample is not the last sample in the pattern<br>10 = Interpolate current sample with next sample<br>11 = Current sample is the last sample in the pattern. Repeat the entire pattern RPTx[3:0] times   |    |          |          |           |    |         |    |
| AmpSign[1:0]     | Sign of haptic amplitude in current sample<br>0 = Positive<br>1 = Negative  |    |          |          |           |    |         |    |
| Amp[6:2]         | Sets the amplitude of pattern sample x as a 7-bit percentage of $V_{FS}$ and a 1-bit direction. See HptVfs[7:0] in <a href="#">Table 138</a> .  |    |          |          |           |    |         |    |
| Dur[4:0]         | Sets the duration of time the driver outputs the amplitude of the current sample in increments of 5ms<br>00000 = 0ms<br>00001 = 5ms<br>...<br>11110 = 150ms<br>11111 = 155ms  |    |          |          |           |    |         |    |
| Wait[4:0]        | Sets the duration of time the driver waits at zero amplitude before the next sample in increments of 5ms<br>00000 = 0ms<br>00001 = 5ms<br>...<br>11110 = 150ms<br>11111 = 155ms   |    |          |          |           |    |         |    |
| RPTx[3:0]        | Sets the number of times to repeat the sample before moving to the next sample in the pattern. If nLSx[1:0] = 11, this sets the number of times to repeat the whole pattern.<br>0000 = Repeat 0 times. If nLSx = 00, automatic braking is performed on this sample with a maximum braking time equal to Wait[4:0].<br>0001 = Repeat 1 time<br>...<br>1110 = Repeat 14 times<br>1111 = Repeat 15 times |    |          |          |           |    |         |    |

|                     |                     |                     |                      |                     |                           |
|---------------------|---------------------|---------------------|----------------------|---------------------|---------------------------|
| nLS0[1:0]           | Amp[7:0]            | Dur[4:0]            | Wait[4:0]            | Rpt[3:0]            |                           |
| nLS <sub>PREV</sub> | Amp <sub>PREV</sub> | Dur <sub>PREV</sub> | Wait <sub>PREV</sub> | Rpt <sub>PREV</sub> | ← END OF PREVIOUS PATTERN |
| 01                  | A0                  | 00010               | 00001                | 0001                |                           |
| 01                  | A1                  | 00011               | 00000                | 0010                |                           |
| 10                  | A2                  | 00011               | 00000                | X                   |                           |
| 10                  | A3                  | 00011               | 00000                | X                   |                           |
| 11                  | A4                  | DC                  | 00010                | 0010                |                           |

Figure 7a. Sample Pattern Stored in RAM

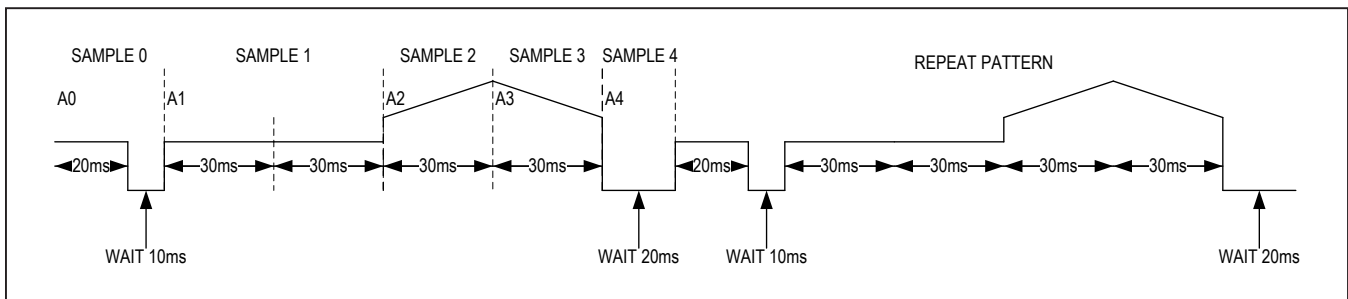

Figure 7b. Haptic Driver Output of Stored Pattern

## Fuel Gauge

### ModelGauge Theory of Operation

The MAX20353 fuel gauge is based on the MAX17048 stand-alone fuel gauge and simulates the internal, non-linear dynamics of a Li+ battery to determine its State of Charge (SOC). The sophisticated battery model considers impedance and the slow rate of chemical reactions in the battery. ModelGauge performs best with a custom model, obtained by characterizing the battery at multiple discharge currents and temperatures to precisely model it. At power-on reset (POR), the ICs have a preloaded ROM model that performs well for some batteries. For more details on the fuel gauge, refer to the MAX17048 data sheet.

### Fuel-Gauge Performance

In coulomb counter-based fuel gauges, SOC drifts because offset error in the current-sense ADC measurement accumulates over time. Instantaneous error can be very

small, but never precisely zero. Error accumulates over time in such systems (typically, 0.5%–2% per day) and requires periodic corrections. Some algorithms correct drift using occasional events and, until such an event occurs, the algorithm’s error is boundless:

- Reaching predefined SOC levels near full or empty
- Measuring the relaxed battery voltage after a long period of inactivity
- Completing a full charge/discharge cycle

ModelGauge requires no correction events because it uses only voltage, which is stable over time. The ModelGauge remains accurate despite the absence of any of the above events; it neither drifts nor accumulates error over time.

To correctly measure performance of a fuel gauge as experienced by end-users, exercise the battery dynamically. Accuracy cannot be fully determined from only simple cycles.



### Battery Voltage and State of Charge

Open-circuit voltage (OCV) of a Li+ battery uniquely determines its SOC; one SOC can have only one value of OCV. In contrast, a given  $V_{CELL}$  can occur at many different values of OCV because  $V_{CELL}$  is a function of time, OCV, load, temperature, age, impedance, etc.; one value of OCV can have many values of  $V_{CELL}$ . Therefore, one SOC can have many values of  $V_{CELL}$ , so  $V_{CELL}$  cannot uniquely determine SOC.

Even the use of sophisticated tables to consider both voltage and load results in significant error due to the load transients typically experienced in a system. During charging or discharging, and for approximately 30 min after,  $V_{CELL}$  and OCV differ substantially, and  $V_{CELL}$  has been affected by the preceding hours of battery activity. ModelGauge uses voltage comprehensively.

### Temperature Compensation

For best performance, the host microcontroller must measure battery temperature periodically, and compensate the RCOMP ModelGauge parameter accordingly, at least once per minute. Each custom model defines constants RCOMP0 (0x97, default), TempCoUp (-0.5, default), and TempCoDown (-5.0, default). To calculate the new value of CONFIG.RCOMP:

```
// T is battery temperature (degrees Celsius)
if (T > 20) {
    RCOMP = RCOMP0 + (T - 20) x TempCoUp;
}
else {
    RCOMP = RCOMP0 + (T - 20) x TempCoDown;
}
```

### Impact of Empty-Voltage Selection

Most applications have a minimum operating voltage below which the system immediately powers off (empty voltage). When characterizing the battery to create a custom model, choose empty voltage carefully. Capacity unavailable to the system increases at an accelerating rate as empty voltage increases.

To ensure a controlled shutdown, consider including operating margin into the fuel gauge based on some low threshold of SOC, for example shutting down at 3% or 5%. This utilizes the battery more effectively than adding error margin to empty voltage.

### Battery Insertion

When the battery is first inserted into the system, the fuel-gauge IC has no previous knowledge about the battery's SOC. Assuming that the battery is relaxed, the IC translates its first  $V_{CELL}$  measurement into the best initial estimate

of SOC. Initial error caused by the battery not being in a relaxed state diminishes over time, regardless of loading following this initial conversion. While SOC estimated by a coulomb counter diverges, ModelGauge SOC converges, correcting error automatically. Initial error has no long-lasting impact.

### Battery Insertion Debounce

Any time the IC powers on or resets (see the [VRESET/ID Register \(0x18\)](#) section), it estimates that OCV is the maximum of 16  $V_{CELL}$  samples (1ms each, full 12-bit resolution). OCV is ready 17ms after battery insertion, and SOC is ready 175ms after that.

### Battery Swap Detection

If  $V_{CELL}$  falls below  $V_{RST}$ , the IC quick-starts once  $V_{CELL}$  returns above  $V_{RST}$ . This handles battery swap; the SOC of the previous battery does not affect that of the new one. See the [Quick-Start and VRESET/ID Register \(0x18\)](#) sections.

### Quick-Start

If the IC generates an erroneous initial SOC, the battery insertion and system power-up voltage waveforms must be examined to determine if a quick-start is necessary, as well as the best time to execute the command. The IC samples the maximum  $V_{CELL}$  during the first 17ms. See the [Battery Insertion Debounce](#) section. Unless  $V_{CELL}$  is fully relaxed, even the best sampled voltage can appear greater or less than OCV. Therefore, quick-start must be used cautiously.

Most systems should not use quick-start because the ICs handle most startup problems transparently, such as intermittent battery-terminal connection during insertion. If battery voltage stabilizes faster than 17ms, do not use quick-start.

The quick-start command restarts fuel-gauge calculations in the same manner as initial power-up of the IC. If the system power-up sequence is so noisy that the initial estimate of SOC has unacceptable error, the system microcontroller may be able to reduce the error by using quick-start. A quick-start is initiated by a rising edge on the QSTRT pin, or by writing 1 to the quick-start bit in the MODE register.

### Power-On Reset (POR)

POR includes a quick-start, so only use it when the battery is fully relaxed. See the [Quick-Start](#) section. This command restores all registers to their default values. After this command, reload the custom model. See the [CMD Register \(0xFE\)](#) section.

### Hibernate Mode

The ICs have a low-power hibernate mode that can accurately fuel gauge the battery when the charge/discharge rate is low. By default, the device automatically enters and exits hibernate mode according to the charge/discharge rate, which minimizes quiescent current (below 5 $\mu$ A) without compromising fuel-gauge accuracy. The ICs can be forced into hibernate or active modes. Force the IC into hibernate mode to reduce power consumption in applications with less than C/4-rate maximum loading. For applications with higher loading, Maxim recommends the default configuration of automatic control of hibernate mode.

In hibernate mode, the device reduces its ADC conversion period and SOC update to once per 45s. See the [HIBRT Register \(0x0A\)](#) section for details on how the IC automatically enters and exits hibernate mode.

### Alert Interrupt

The ICs can interrupt a system microcontroller with five configurable alerts. All alerts can be disabled or enabled with software. When the interrupt occurs, the system microcontroller can determine the cause from the STATUS register.

When an alert is triggered, the IC drives the  $\overline{\text{ALRT}}$  pin logic-low and sets CONFIG.ALRT = 1. The  $\overline{\text{ALRT}}$  pin remains logic-low until the system software writes CONFIG.ALRT = 0 to clear the alert. The alert function is enabled by default, so any alert can occur immediately upon power-up. Entering sleep mode clears no alerts.

### Sleep Mode

In sleep mode, the IC halts all operations, reducing current consumption to below 1 $\mu$ A. After exiting sleep mode, the IC continues normal operation. In sleep mode, the IC does not detect self-discharge. If the battery changes state while the IC sleeps, the IC cannot detect it, causing SOC error. Wake up the IC before charging or discharging. To enter sleep mode, write MODE.EnSleep = 1 and either:

Hold SDA and SCL logic-low for a period for  $t_{\text{SLEEP}}$ . A rising edge on SDA or SCL wakes up the IC.

Write CONFIG.SLEEP = 1. To wake up the IC, write CONFIG.SLEEP = 0. Other communication does not wake up the IC. POR does wake up the IC.

Therefore, applications that can tolerate 4 $\mu$ A should use hibernate mode rather than Sleep mode.

### I<sup>2</sup>C Interface

The MAX20353 uses the two-wire I<sup>2</sup>C interface to communicate with a host microcontroller. The configuration settings and status information provided through this interface are detailed in the register descriptions. To simplify the use of existing code and drivers designed for interfacing with the ModelGauge fuel gauge, the MAX20353 appears as two devices on an I<sup>2</sup>C bus. The main device controlling the regulators, charger, and other system functions has the seven-bit slave address 0b0101000 (0x50 for writes, 0x51 for reads). Accessing the fuel gauge is done using the seven-bit slave address 0b0110110 (0x6C for writes, 0x6D for reads).

## Applications Information

### I<sup>2</sup>C Interface

The MAX20353 contains an I<sup>2</sup>C-compatible interface for data communication with a host controller (SCL and SDA). The interface supports a clock frequency of up to 400kHz. SCL and SDA require pullup resistors that are connected to a positive supply.

### Start, Stop, And Repeated Start Conditions

When writing to the MAX20353 using I<sup>2</sup>C, the master sends a START condition (S) followed by the MAX20353 I<sup>2</sup>C address. After the address, the master sends the register address of the register that is to be programmed. The master then ends communication by issuing a STOP condition (P) to relinquish control of the bus, or a REPEATED START condition (Sr) to communicate to another I<sup>2</sup>C slave. See [Figure 8](#).

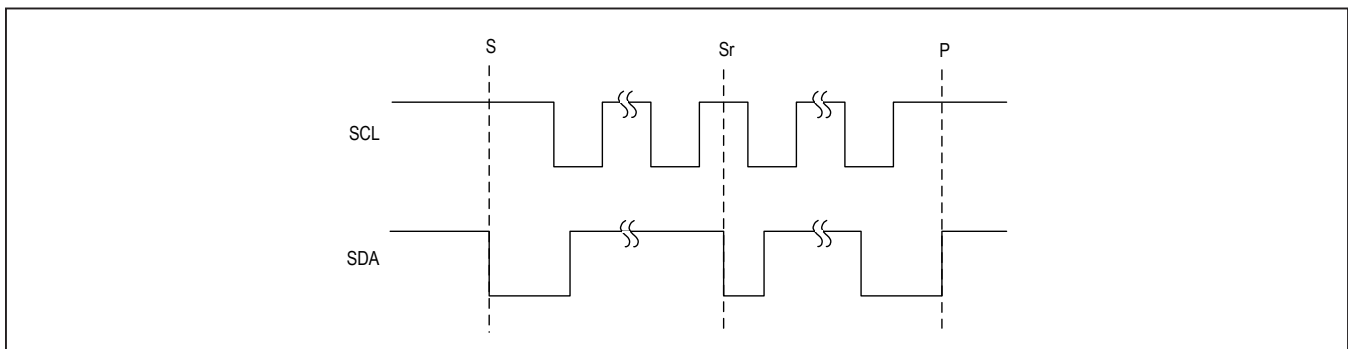

Figure 8. I<sup>2</sup>C START, STOP and REPEATED START Conditions

**Slave Address**

Set the Read/Write bit high to configure the MAX20353 to read mode. Set the Read/Write bit low to configure the MAX20353 to write mode. The address is the first byte of information sent to the MAX20353 after the START condition.

**Bit Transfer**

One data bit is transferred on the rising edge of each SCL clock cycle. The data on SDA must remain stable during the high period of the SCL clock pulse. Changes in SDA while SCL is high and stable are considered control signals (see the *Start, Stop, And Repeated Start Conditions* section). Both SDA and SCL remain high when the bus is not active.

**Single-Byte Write**

In this operation, the master sends an address and two data bytes to the slave device (Figure 9). The following procedure describes the single byte write operation:

- The master sends a START condition
- The master sends the 7-bit slave address plus a write bit (low)
- The addressed slave asserts an ACK on the data line
- The master sends the 8-bit register address
- The slave asserts an ACK on the data line only if the address is valid (NAK if not)

- The master sends 8 data bits
- The slave asserts an ACK on the data line
- The master generates a STOP condition

**Burst Write**

In this operation, the master sends an address and multiple data bytes to the slave device (Figure 10). The slave device automatically increments the register address after each data byte is sent, unless the register being accessed is 0x00, in which case the register address remains the same. The following procedure describes the burst write operation:

- The master sends a START condition
- The master sends the 7-bit slave address plus a write bit (low)
- The addressed slave asserts an ACK on the data line
- The master sends the 8-bit register address
- The slave asserts an ACK on the data line only if the address is valid (NAK if not)
- The master sends 8 data bits
- The slave asserts an ACK on the data line
- Repeat 6 and 7 N-1 times
- The master generates a STOP condition

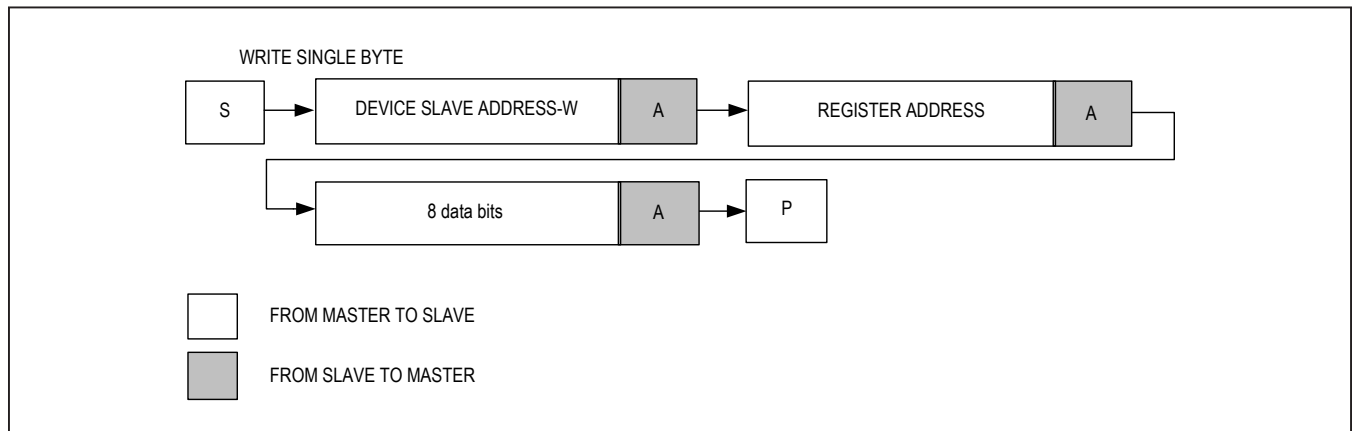

Figure 9. Write Byte Sequence



**Single Byte Read**

In this operation, the master sends an address plus two data bytes and receives one data byte from the slave device (Figure 11). The following procedure describes the single byte read operation:

- The master sends a START condition
- The master sends the 7-bit slave address plus a write bit (low)
- The addressed slave asserts an ACK on the data line
- The master sends the 8-bit register address

- The slave asserts an ACK on the data line only if the address is valid (NAK if not)
- The master sends a REPEATED START condition
- The master sends the 7-bit slave address plus a read bit (high)
- The addressed slave asserts an ACK on the data line
- The slave sends 8 data bits
- The master asserts a NACK on the data line
- The master generates a STOP condition

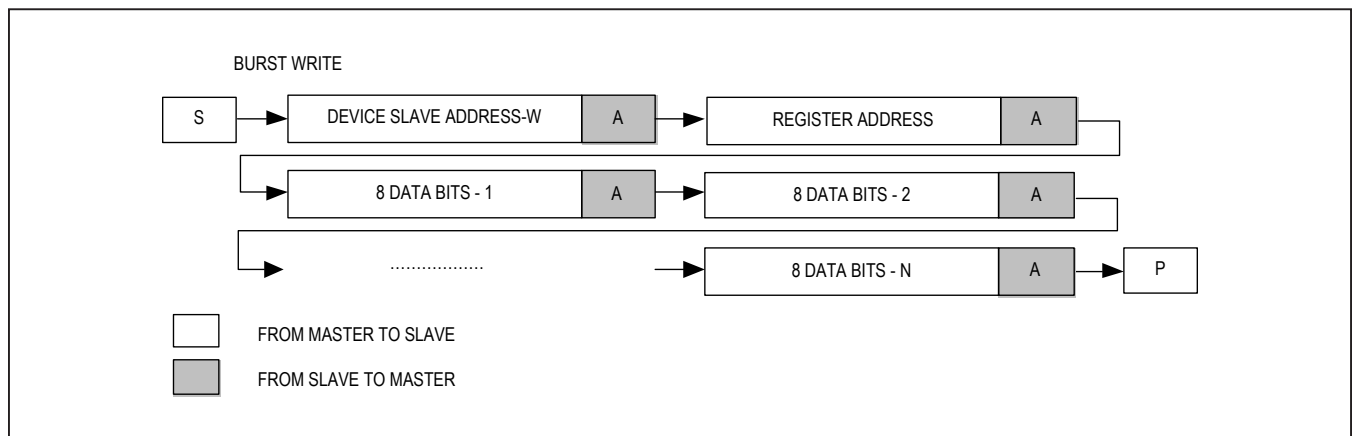

Figure 10. Burst Write Sequence

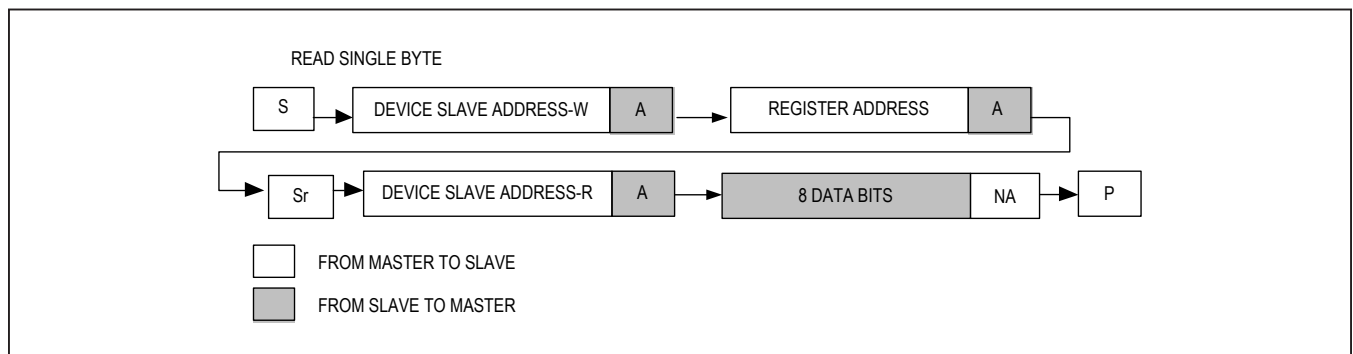

Figure 11. Read Byte Sequence

**Burst Read**

In this operation, the master sends an address plus two data bytes and receives multiple data bytes from the slave device (Figure 12). The following procedure describes the burst byte read operation:

- The master sends a START condition
- The master sends the 7-bit slave address plus a write bit (low)
- The addressed slave asserts an ACK on the data line
- The master sends the 8-bit register address
- The slave asserts an ACK on the data line only if the address is valid (NAK if not)
- The master sends a REPEATED START condition
- The master sends the 7-bit slave address plus a read bit (high)
- The slave asserts an ACK on the data line

- The slave sends 8 data bits
- The master asserts an ACK on the data line
- Repeat 9 and 10 N-2 times
- The slave sends the last 8 data bits
- The master asserts a NACK on the data line
- The master generates a STOP condition

**Acknowledge Bits**

Data transfers are acknowledged with an acknowledge bit (ACK) or a not-acknowledge bit (NACK). Both the master and the MAX20353 generate ACK bits. To generate an ACK, pull SDA low before the rising edge of the ninth clock pulse and hold it low during the high period of the ninth clock pulse (see Figure 13). To generate a NACK, leave SDA high before the rising edge of the ninth clock pulse and leave it high for the duration of the ninth clock pulse. Monitoring for NACK bits allows for detection of unsuccessful data transfers.

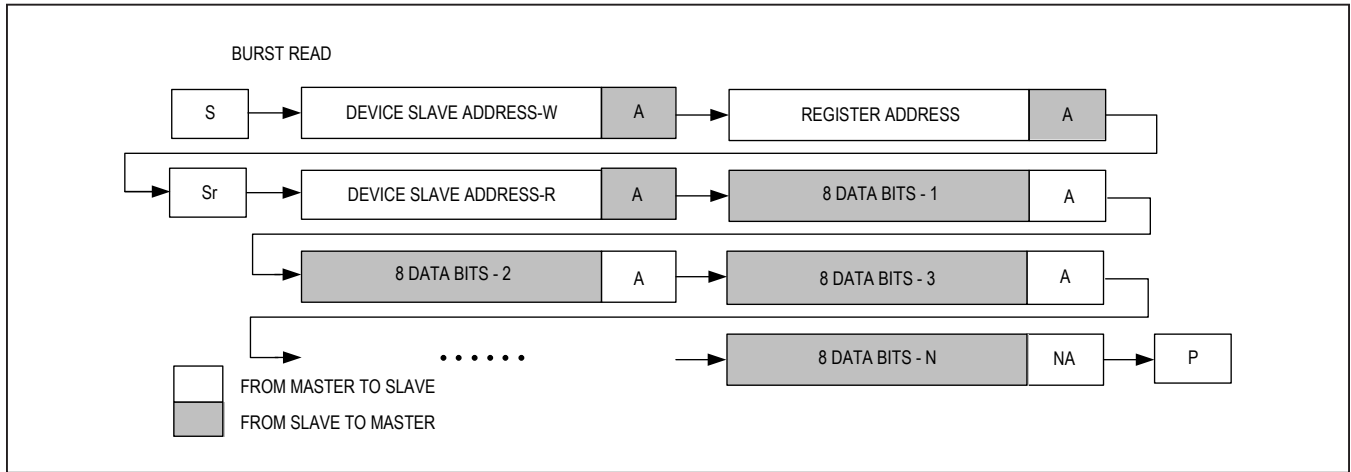

Figure 12. Burst Read Sequence

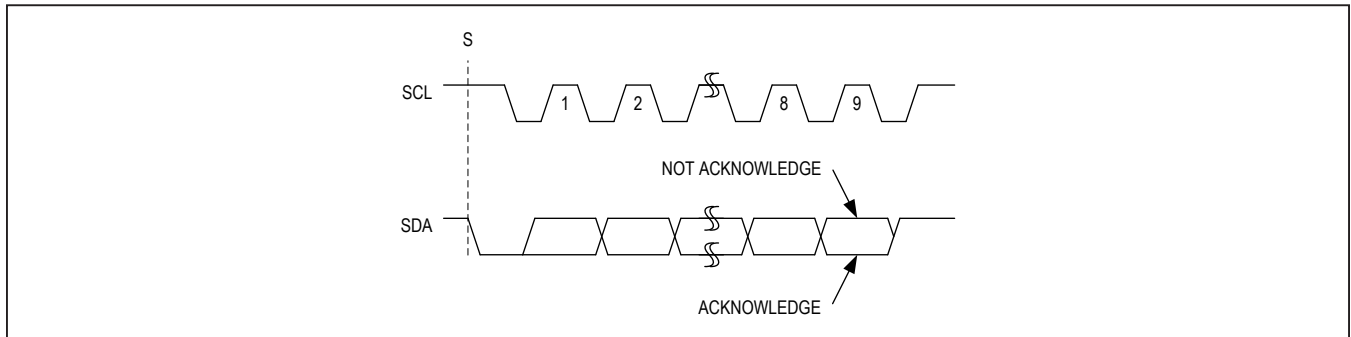

Figure 13. Acknowledge

**Application Processor Interface**

Several of the MAX20353's functions are controlled by an Application Processor (AP). AP commands read and write configuration settings to the internal registers. Data transfer is handled by the AP controller and is triggered by writes to APCmdOut. There is a 5ms (typ), 9ms (max) latency associated with setting commands. This delay increases if the command requires additional processes such as ADC measurements, haptic autotune, etc. When the transfer is complete, INT goes low, APCmdResponseInt (bit seven of direct register Int2 (0x05)) is set, and the controller writes the value of the received opcode to APResponse. Reading the data in APResponse provides verification of the successful execution of an opcode.

**AP Write**

To set configuration registers, data must first be written to the APDataOut0-5 registers. Tables 54 to 197 detail the functions of each APDataOut\_ register for a given opcode. Once APDataOut0-5 contain the configuration bytes, writing an opcode to APCmdOut signals the controller to transfer data to the internal registers. Note that a write opcode only transfers the number of bytes defined by the command. The controller ignores the contents of all extra APDataOut\_ registers. See Figure 14 for the structure of an AP write procedure with an APResponse opcode check.

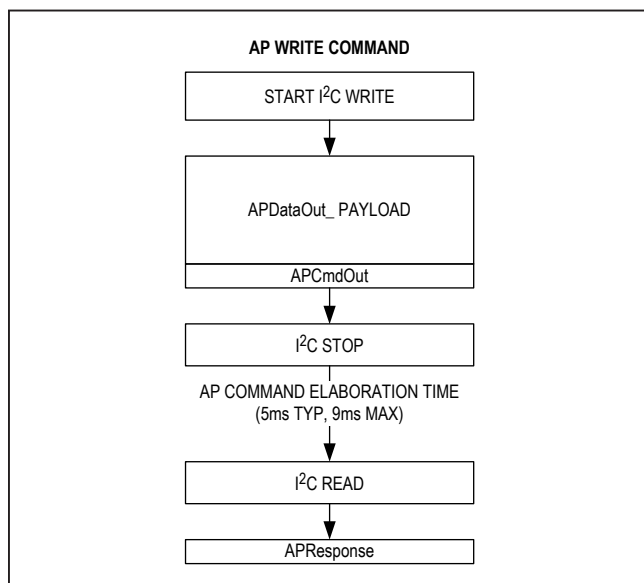

Figure 14. Executing a Write Opcode and Reading the MAX20353 Response

**AP Read**

To read a configuration register, APCmdOut is set to a read opcode. Read opcodes signal the controller to transfer the internal register contents to the APDataIn0-5 registers. When the transfer is complete, APDataIn0-5 contain the stored configuration settings or operation results and can be read over I2C. Because read opcodes expect no inputs, any data stored in APDataOut0-5 is ignored. Figure 15 illustrates the AP read processes.

**AP Launch**

Certain commands trigger additional functions in the MAX20353. These commands, such as ADC\_Measure\_Launch (opcode 0x53) and HPT\_Autotune (opcode 0xAC), can require additional elaboration time for taking measurements and computing the result. When the process is complete, results may be read from APDataIn0-5 as in normal AP Read commands.

**Write-Protected Commands and Fields**

If the factory configured bit WriteProtect is enabled, the AP commands InputCurrent\_Config\_Write (0x10), Charger\_Config\_Write (0x14), and Charger\_ControlWrite (0x1A) are not accessible. If the application processor issues a request to one of these commands, the device will respond with the SysError code MA\_SYSERROR\_APCMD\_WRITEPROTECT.

A settings are also write protected, but it is possible to write these settings using an additional field in the command that contains a password.

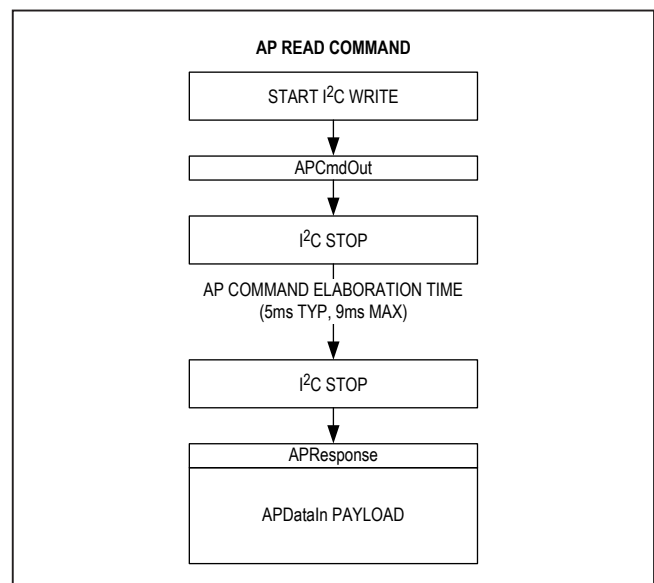

Figure 15. Executing a Read Opcode and Reading the MAX20353 Response

Direct Access I2C Register Map

| REGISTER ADDRESS | REGISTER NAME  | RW  | B7               | B6          | B5           | B4           | B3           | B2             | B1              | B0            |
|------------------|----------------|-----|------------------|-------------|--------------|--------------|--------------|----------------|-----------------|---------------|
| 0x00             | HardwareID     | R   | HardwareID[7:0]  |             |              |              |              |                |                 |               |
| 0x01             | FirmwareID     | R   | FirmwareID[7:0]  |             |              |              |              |                |                 |               |
| 0x03             | Int0           | COR | ThmStatInt       | ChgStatInt  | ILimInt      | UsbOVPInt    | UsbOkInt     | ChgThmSdInt    | ThmRegInt       | ChgTmoInt     |
| 0x04             | Int1           | COR | ThmSDInt         | BstFltInt   | ThmBuck2Int  | ThmBuck1Int  | UVLOLDO2Int  | UVLOLDO1Int    | ThmLDO2Int      | ThmLDO1Int    |
| 0x05             | Int2           | COR | APCmdResplnt     | SysErrInt   | —            | LRALockInt   | LRAAActInt   | BBstThmInt     | SysBatLimInt    | ChgSysLimInt  |
| 0x06             | Status0        | R   | —                | —           | ThmStat[2:0] |              | ChgStat[2:0] |                | —               |               |
| 0x07             | Status1        | R   | —                | —           | ILim         | UsbOVP       | UsbOk        | ChgJEITASD     | ChgJEITAReg     | ChgTmo        |
| 0x08             | Status2        | R   | ThmSD            | BstFlt      | ThmBuck2     | ThmBuck1     | UVLOLDO2     | UVLOLDO1       | ThmLDO2         | ThmLDO1       |
| 0x09             | Status3        | R   | APCmdResp        | SysErr      | —            | LRALock      | LRAAAct      | BBstThm        | SysBatLim       | ChgSysLim     |
| 0x0B             | SystemError    | R   | SystemError[7:0] |             |              |              |              |                |                 |               |
| 0x0C             | IntMask0       | RW  | ThmStatIntM      | ChgStatIntM | ILimIntM     | UsbOVPIntM   | UsbOkIntM    | ChgJEITASDIntM | ChgJEITARegIntM | ChgTmoIntM    |
| 0x0D             | IntMask1       | RW  | ThmSdIntM        | BstFltIntM  | ThmBuck2IntM | ThmBuck1IntM | UVLOLDO2IntM | UVLOLDO1IntM   | ThmLDO2IntM     | ThmLDO1IntM   |
| 0x0E             | IntMask2       | RW  | APCmdResplntM    | SysErrIntM  | —            | LRALockIntM  | LRAAActIntM  | BBstThmIntM    | SysBatLimIntM   | ChgSysLimIntM |
| 0x0F             | APDataOut0     | RW  | APDataOut0[7:0]  |             |              |              |              |                |                 |               |
| 0x10             | APDataOut1     | RW  | APDataOut1[7:0]  |             |              |              |              |                |                 |               |
| 0x11             | APDataOut2     | RW  | APDataOut2[7:0]  |             |              |              |              |                |                 |               |
| 0x12             | APDataOut3     | RW  | APDataOut3[7:0]  |             |              |              |              |                |                 |               |
| 0x13             | APDataOut4     | RW  | APDataOut4[7:0]  |             |              |              |              |                |                 |               |
| 0x14             | APDataOut5     | RW  | APDataOut5[7:0]  |             |              |              |              |                |                 |               |
| 0x15             | APDataOut6     | RW  | APDataOut6[7:0]  |             |              |              |              |                |                 |               |
| 0x17             | APCmdOut       | RW  | APCmdOut[7:0]    |             |              |              |              |                |                 |               |
| 0x18             | APResponse     | R   | APResponse[7:0]  |             |              |              |              |                |                 |               |
| 0x19             | APDataIn0      | R   | APDataIn0[7:0]   |             |              |              |              |                |                 |               |
| 0x1A             | APDataIn1      | R   | APDataIn1[7:0]   |             |              |              |              |                |                 |               |
| 0x1B             | APDataIn2      | R   | APDataIn2[7:0]   |             |              |              |              |                |                 |               |
| 0x1C             | APDataIn3      | R   | APDataIn3[7:0]   |             |              |              |              |                |                 |               |
| 0x1D             | APDataIn4      | R   | APDataIn4[7:0]   |             |              |              |              |                |                 |               |
| 0x1E             | APDataIn5      | R   | APDataIn5[7:0]   |             |              |              |              |                |                 |               |
| 0x1F             | Buck1I2CDVS    | RW  | —                | —           | —            | —            | —            | —              | —               | Buck1I2CDVSEn |
| 0x20             | LDODirect      | RW  | —                | —           | —            | —            | —            | —              | —               | LDO1DirEn     |
| 0x21             | MPCDirectWrite | RW  | —                | —           | —            | MPC4Write    | MPC3Write    | MPC2Write      | MPC1Write       | MPC0Write     |

Direct Access I2C Register Map (continued)

| REGISTER ADDRESS | REGISTER NAME | RW | B7                  | B6        | B5       | B4                 | B3                 | B2                   | B1                  | B0         |                     |
|------------------|---------------|----|---------------------|-----------|----------|--------------------|--------------------|----------------------|---------------------|------------|---------------------|
| 0x22             | MPCDirectRead | R  | —                   | —         | —        | MPC4Read           | MPC3Read           | MPC2Read             | MPC1Read            | MPC0Read   |                     |
| 0x23             | DVSVI1        | RW | —                   | —         | —        | —                  | Buck1DVSVSet1[5:0] |                      |                     |            |                     |
| 0x24             | DVSVI2        | RW | —                   | —         | —        | —                  | Buck1DVSVSet2[5:0] |                      |                     |            |                     |
| 0x25             | DVSVI3        | RW | —                   | —         | —        | —                  | Buck1DVSVSet3[5:0] |                      |                     |            |                     |
| 0x26             | ActBrkCfg0    | RW | —                   | —         | —        | —                  | AutoBrkPeak Meas   | AutoBrkFiltrSat Stop | AutoBrkDis          | AutoBrkDis |                     |
| 0x27             | ActBrkCfg1    | RW | AutoBrkMeasWdw[3:0] |           |          | AutoBrkMeasTh[1:0] |                    |                      | AutoBrkMeasEnd[1:0] |            | AutoBrkDis          |
| 0x28             | HptRAMAddr    | RW | HptRAMAddr[7:0]     |           |          |                    |                    |                      |                     |            | AutoBrkMeasEnd[1:0] |
| 0x29             | HptRAMDataH   | RW | nLSx[1:0]           | AmpSign   |          |                    | Amp[6:2]           |                      |                     |            | AutoBrkDis          |
| 0x2A             | HptRAMDataM   | RW | Amp[1:0]            | Wait[3:0] |          |                    | Dur[4:0]           |                      |                     |            | Wait[4]             |
| 0x2B             | HptRAMDataL   | RW | Wait[3:0]           |           |          | Rpt[3:0]           |                    |                      | LDO1_MPC2CNF        |            | LEDIStep[1:0]       |
| 0x2C             | LEDStepDirect | RW | LED2Open            | LED1Open  | LED0Open | —                  | LDO1_MPC2CNT       | LDO1_Set[4:0]        | LEDISet[1:0]        |            |                     |
| 0x2D             | LED0Direct    | RW | LED0En[2:0]         |           |          | LED0Set[4:0]       |                    |                      |                     |            |                     |
| 0x2E             | LED1Direct    | RW | LED1En[2:0]         |           |          | LED1Set[4:0]       |                    |                      |                     |            |                     |
| 0x2F             | LED2Direct    | RW | LED2En[2:0]         |           |          | LED2Set[4:0]       |                    |                      |                     |            |                     |
| 0x30             | HptDirect0    | RW | —                   | —         | —        | —                  | HptOffImp          | HptThmProtDis        | HptOCProtDis        |            |                     |
| 0x31             | HptDirect1    | RW | HptExtTrig          | HptRamEn  | HptDrvEn | HptDrvModel[4:0]   |                    |                      |                     |            |                     |
| 0x32             | HptRTI2CAmp   | RW | HptRTI2CSign        |           |          | HptRTI2CAmp [6:0]  |                    |                      |                     |            |                     |
| 0x33             | HptPatRAMAddr | RW | HptPatRAMAddr[7:0]  |           |          |                    |                    |                      |                     |            | AutoBrkDis          |

**Direct Access I<sup>2</sup>C Register Descriptions****Table 5. HardwareID Register (0x00)**

|                  |   |   |   |   |   |   |   |   |
|------------------|---|---|---|---|---|---|---|---|
| ADDRESS:         | 0x00  |   |   |   |   |   |   |   |
| MODE:            | Read Only   |   |   |   |   |   |   |   |
| BIT              | 7   | 6 | 5 | 4 | 3 | 2 | 1 | 0 |
| NAME             | HardwareID[7:0]   |   |   |   |   |   |   |   |
| HardwareID [7:0] | HardwareID[7:0] bits show information about the hardware revision of the MAX20353 |   |   |   |   |   |   |   |

**Table 6. FirmwareID Register (0x01)**

|                  |   |   |   |   |   |   |   |   |
|------------------|---|---|---|---|---|---|---|---|
| ADDRESS:         | 0x01  |   |   |   |   |   |   |   |
| MODE:            | Read Only   |   |   |   |   |   |   |   |
| BIT              | 7   | 6 | 5 | 4 | 3 | 2 | 1 | 0 |
| NAME             | FirmwareID[7:0]   |   |   |   |   |   |   |   |
| FirmwareID [7:0] | FirmwareID[7:0] bits show information about the firmware revision of the MAX20353 |   |   |   |   |   |   |   |

**Interrupt Registers****Table 7. Int0 Register (0x03)**

|             |  |            |         |           |          |             |           |           |
|-------------|--|------------|---------|-----------|----------|-------------|-----------|-----------|
| ADDRESS:    | 0x03   |            |         |           |          |             |           |           |
| MODE:       | Clear On Read  |            |         |           |          |             |           |           |
| BIT         | 7  | 6          | 5       | 4         | 3        | 2           | 1         | 0         |
| NAME        | ThmStatInt   | ChgStatInt | ILimInt | UsbOVPInt | UsbOkInt | ChgThmSDInt | ThmRegInt | ChgTmolnt |
| ThmStatInt  | Change in ThmStat caused interrupt.  |            |         |           |          |             |           |           |
| ChgStatInt  | Change in ChgStat caused interrupt, or first detection complete after POR.   |            |         |           |          |             |           |           |
| ILimInt     | Input current limit caused interrupt.  |            |         |           |          |             |           |           |
| UsbOVPInt   | Change in USBOVP caused interrupt.   |            |         |           |          |             |           |           |
| UsbOkInt    | Change in USBOK caused interrupt. Note: Registers written using opcodes 0x10, 0x14, 0x16, 0x18, 0x1A, and 0x1C are reset on charger insertion. After receiving a UsbOk interrupt, wait 10ms before writing any data using these opcodes. Failure to wait 10ms may result in the data being overwritten to the default. |            |         |           |          |             |           |           |
| ChgThmSDInt | Change in ChgThmSD caused interrupt.   |            |         |           |          |             |           |           |
| ThmRegInt   | Change in ChgThmReg caused interrupt.  |            |         |           |          |             |           |           |
| ChgTmolnt   | Change in ChgTmolnt caused interrupt.  |            |         |           |          |             |           |           |

**Table 8. Int1 Register (0x04)**

|             |                                      |           |             |             |             |             |            |            |
|-------------|--------------------------------------|-----------|-------------|-------------|-------------|-------------|------------|------------|
| ADDRESS:    | 0x04                                 |           |             |             |             |             |            |            |
| MODE:       | Clear On Read                        |           |             |             |             |             |            |            |
| BIT         | 7                                    | 6         | 5           | 4           | 3           | 2           | 1          | 0          |
| NAME        | ThmSDInt                             | BstFltInt | ThmBuck2Int | ThmBuck1Int | UVLLODO2Int | UVLLODO1Int | ThmLDO2Int | ThmLDO1Int |
| ThmSDInt    | Change in ThmSD caused interrupt.    |           |             |             |             |             |            |            |
| BstFltInt   | Change in BstFlt caused interrupt.   |           |             |             |             |             |            |            |
| ThmBuck2Int | Change in ThmBuck2 caused interrupt. |           |             |             |             |             |            |            |
| ThmBuck1Int | Change in ThmBuck1 caused interrupt. |           |             |             |             |             |            |            |
| UVLLODO2Int | Change in UVLLODO2 caused interrupt. |           |             |             |             |             |            |            |
| UVLLODO1Int | Change in UVLLODO1 caused interrupt. |           |             |             |             |             |            |            |
| ThmLDO2Int  | Change in ThmLDO2 caused interrupt.  |           |             |             |             |             |            |            |
| ThmLDO1Int  | Change in ThmLDO1 caused interrupt.  |           |             |             |             |             |            |            |

**Table 9. Int2 Register (0x05)**

|              |  |           |   |             |           |            |              |                  |
|--------------|--|-----------|---|-------------|-----------|------------|--------------|------------------|
| ADDRESS:     | 0x05   |           |   |             |           |            |              |                  |
| MODE:        | Clear On Read  |           |   |             |           |            |              |                  |
| BIT          | 7  | 6         | 5 | 4           | 3         | 2          | 1            | 0                |
| NAME         | APCmdRes<br>pInt   | SysErrInt | — | LRA LockInt | LRAActInt | BBstThmInt | SysBatLimInt | ChgSysLi<br>mInt |
| APCmdResInt  | AP Command Response Interrupt<br>0 = No new data available in APDataIn registers.<br>1 = New data available in APDataIn registers. |           |   |             |           |            |              |                  |
| SysErrInt    | System Error Interrupt<br>0 = No new error<br>1 = New Asynchronous System Error  |           |   |             |           |            |              |                  |
| LRA LockInt  | LRA Lock Interrupt<br>Change in LRA Lock caused interrupt.   |           |   |             |           |            |              |                  |
| LRAActInt    | Change in LRAAct caused interrupt.   |           |   |             |           |            |              |                  |
| BBstThmInt   | Change in BBstThm caused interrupt.  |           |   |             |           |            |              |                  |
| SysBatLimInt | Change in SysBatLim caused interrupt.  |           |   |             |           |            |              |                  |
| ChgSysLimInt | Change in ChgSysLim caused interrupt.  |           |   |             |           |            |              |                  |

**Status Registers****Table 10. Status0 Register (0x06)**

|              |   |   |              |   |   |              |   |   |
|--------------|---|---|--------------|---|---|--------------|---|---|
| ADDRESS:     | 0x06  |   |              |   |   |              |   |   |
| MODE:        | Read Only   |   |              |   |   |              |   |   |
| BIT          | 7   | 6 | 5            | 4 | 3 | 2            | 1 | 0 |
| NAME         | —   | — | ThmStat[2:0] |   |   | ChgStat[2:0] |   |   |
| ThmStat[2:0] | Status of Thermistor Monitoring<br>000 = T < T1<br>001 = T1 < T < T2<br>010 = T2 < T < T3<br>011 = T3 < T < T4<br>100 = T > T4<br>101 = No thermistor detected/THM high due to external pull-up<br>110 = NTC input disabled via ThmEn<br>111 = Automatic monitoring disabled because CHGIN is not present. THM can still be measured by ADC_<br>Measure_Launch  |   |              |   |   |              |   |   |
| ChgStat[2:0] | Status of Charger Mode<br>000 = Charger off<br>001 = Charging suspended due to temperature (see battery charger state diagram)<br>010 = Pre-charge in progress<br>011 = Fast-charge constant current mode in progress<br>100 = Fast-charge constant voltage mode in progress<br>101 = Maintain charge in progress<br>110 = Maintain charger timer done<br>111 = Charger fault condition (see battery charger state diagram) |   |              |   |   |              |   |   |

**Table 11. Status1 Register (0x07)**

|             |  |   |      |        |       |                |                 |        |
|-------------|--|---|------|--------|-------|----------------|-----------------|--------|
| ADDRESS:    | 0x07   |   |      |        |       |                |                 |        |
| MODE:       | Read Only  |   |      |        |       |                |                 |        |
| BIT         | 7  | 6 | 5    | 4      | 3     | 2              | 1               | 0      |
| NAME        | —  | — | ILim | UsbOVP | UsbOk | ChgJEITA<br>SD | ChgJEITA<br>Reg | ChgTmo |
| ILim        | CHGIN Input Current Limit<br>0 = CHGIN input current below limit<br>1 = CHGIN input current limit active   |   |      |        |       |                |                 |        |
| UsbOVP      | Status of CHGIN OVP<br>0 = CHGIN overvoltage not detected<br>1 = CHGIN overvoltage detected  |   |      |        |       |                |                 |        |
| UsbOk       | Status of CHGIN Input<br>0 = CHGIN Input not present or outside of valid range<br>1 = CHGIN Input present and valid  |   |      |        |       |                |                 |        |
| ChgJEITASD  | Status of Thermal Shutdown<br>0 = Charger in normal operating mode<br>1 = Charger is in thermal shutdown   |   |      |        |       |                |                 |        |
| ChgJEITAReg | Status of Thermal Regulation<br>0 = Charger is functioning normally, or disabled<br>1 = Charger is running in thermal regulation mode and charging current is being actively reduced according to JEITA settings |   |      |        |       |                |                 |        |
| ChgTmo      | Status of Time-Out Condition<br>0 = Charger is running normally, or disabled<br>1 = Charger has reached a time-out condition   |   |      |        |       |                |                 |        |



**Table 12. Status2 Register (0x08)**

|          |  |        |          |          |              |          |         |         |
|----------|--|--------|----------|----------|--------------|----------|---------|---------|
| ADDRESS: | 0x08   |        |          |          |              |          |         |         |
| MODE:    | Read Only  |        |          |          |              |          |         |         |
| BIT      | 7  | 6      | 5        | 4        | 3            | 2        | 1       | 0       |
| NAME     | ThmSD  | BstFit | ThmBuck2 | ThmBuck1 | UVLOLD<br>O2 | UVLOLDO1 | ThmLDO2 | ThmLDO1 |
| ThmSD    | 0 = Device operating normally<br>1 = Device in thermal shutdown                                      |        |          |          |              |          |         |         |
| BstFit   | 0 = HV Boost operating normally<br>1 = HV Boost in fault mode due to overcurrent or thermal shutdown |        |          |          |              |          |         |         |
| ThmBuck2 | 0 = Buck2 operating normally<br>1 = Buck2 in thermal shutdown  |        |          |          |              |          |         |         |
| ThmBuck1 | 0 = Buck1 operating normally<br>1 = Buck1 in thermal shutdown  |        |          |          |              |          |         |         |
| UVLOLDO2 | 0 = LDO2 operating normally<br>1 = LDO2 UVLO active  |        |          |          |              |          |         |         |
| UVLOLDO1 | 0 = LDO1 operating normally<br>1 = LDO1 UVLO active  |        |          |          |              |          |         |         |
| ThmLDO2  | 0 = LDO2 operating normally<br>1 = LDO2 in thermal shutdown  |        |          |          |              |          |         |         |
| ThmLDO1  | 0 = LDO1 operating normally<br>1 = LDO1 in thermal shutdown  |        |          |          |              |          |         |         |

**Table 13. Status3 Register (0x09)**

|           |   |        |   |         |        |         |           |           |
|-----------|---|--------|---|---------|--------|---------|-----------|-----------|
| ADDRESS:  | 0x09  |        |   |         |        |         |           |           |
| MODE:     | Read Only   |        |   |         |        |         |           |           |
| BIT       | 7   | 6      | 5 | 4       | 3      | 2       | 1         | 0         |
| NAME      | APCmdResp   | SysErr | — | LRALock | LRAAct | BBstThm | SysBatLim | ChgSysLim |
| APCmdResp | AP Command Response Ready<br>0 = APResponse register is empty<br>1 = APResponse register contains an opcode                                   |        |   |         |        |         |           |           |
| SysErr    | System Error Detect<br>0 = No system error<br>1 = System error detected. See SystemError (register 0x0B)                                      |        |   |         |        |         |           |           |
| LRALock   | 0 = Haptic driver is not active or has not yet locked onto LRA resonant frequency<br>1 = Haptic driver has locked onto LRA resonant frequency |        |   |         |        |         |           |           |
| LRAAct    | 0 = LRA driver not active<br>1 = LRA driver active  |        |   |         |        |         |           |           |
| BBstThm   | 0 = Buck-boost converter operating normally<br>1 = Buck-boost converter in thermal shutdown   |        |   |         |        |         |           |           |
| SysBatLim | 0 = Charge current is not being actively reduced to regulate SYS<br>1 = Charge current actively being reduced to regulate SYS collapse        |        |   |         |        |         |           |           |
| ChgSysLim | 0 = Input current limit normal<br>1 = Input current limit being reduced to regulate CHGIN collapse  |        |   |         |        |         |           |           |

**Table 14. SystemError Register (0x0B)**

|                  |  |   |   |   |   |   |   |   |
|------------------|--|---|---|---|---|---|---|---|
| ADDRESS:         | 0x0B   |   |   |   |   |   |   |   |
| MODE:            | Read Only  |   |   |   |   |   |   |   |
| BIT              | 7  | 6 | 5 | 4 | 3 | 2 | 1 | 0 |
| NAME             | SystemError[7:0]   |   |   |   |   |   |   |   |
| SystemError[7:0] | <p>Last System Error Code:</p> <p>0x00 - MA_SYSError_NONE: No System Error</p> <p>0x01 - MA_SYSError_BOOT:</p> <p>0x02 - MA_SYSError_BOOT_WDT: Restart due to a watchdog event</p> <p>0x03 - MA_SYSError_BOOT_SWRSTREQ: Restart after Hard-Reset procedure</p> <p>0x04 - MA_SYSError_HPT_TIMEOUT: Haptic driver disabled after timeout set through HptDrvTmo[5:0] has expired</p><br><p>0x10 - MA_SYSError_APCMD_INPROGRESS: Attempt to use an AP command before previous command completed</p> <p>0x11 - MA_SYSError_APCMD_WRITEPROTECT: Attempt to use a write protected command or invalid password</p> <p>0x12 - MA_SYSError_APCMD_UNKNOWN: Attempt to use an undefined command</p> <p>0x13 - MA_SYSError_APCMD_FAIL: AP command failed to execute</p><br><p>0x20 - MA_SYSError_HPT_DRP_LOW: Haptic driver disabled due to overcurrent condition on the DRP low-side switch</p> <p>0x21 - MA_SYSError_HPT_DRP_HIG: Haptic driver disabled due to overcurrent condition on the DRP high-side switch</p> <p>0x22 - MA_SYSError_HPT_DRN_LOW: Haptic driver disabled due to overcurrent condition on the DRN low-side switch</p> <p>0x23 - MA_SYSError_HPT_DRN_HIG: Haptic driver disabled due to overcurrent condition on the DRN high-side switch</p> <p>0x24 - MA_SYSError_HPT_THM_ERR: Haptic driver disabled due to thermal shutdown</p> <p>0x25 - MA_SYSError_HPT_SYS_THR_HIT: Haptic driver disabled due to SYS falling below HptSysUVLO[7:0] threshold</p> |   |   |   |   |   |   |   |

**Interrupt Mask Registers****Table 15. IntMask0 Register (0x0C)**

|                 |   |                 |          |                |               |                    |                     |                |
|-----------------|---|-----------------|----------|----------------|---------------|--------------------|---------------------|----------------|
| ADDRESS:        | 0x0C  |                 |          |                |               |                    |                     |                |
| MODE:           | Read/Write  |                 |          |                |               |                    |                     |                |
| BIT             | 7   | 6               | 5        | 4              | 3             | 2                  | 1                   | 0              |
| NAME            | ThmStat<br>IntM   | ChgStat<br>IntM | ILimIntM | UsbOVP<br>IntM | UsbOk<br>IntM | ChgJEITASD<br>IntM | ThmJEITA<br>RegIntM | ChgTmo<br>IntM |
| ThmStatIntM     | ThmStatIntM masks the ThmStatInt interrupt in the Int0 register (0x03).<br>0 = Masked<br>1 = Not masked   |                 |          |                |               |                    |                     |                |
| ChgStatIntM     | ChgStatIntM masks the ChgStatInt interrupt in the Int0 register (0x03).<br>0 = Masked<br>1 = Not masked   |                 |          |                |               |                    |                     |                |
| ILimIntM        | ILimIntM masks the ILimInt interrupt in the Int0 register (0x03).<br>0 = Masked<br>1 = Not masked         |                 |          |                |               |                    |                     |                |
| UsbOVPIntM      | UsbOVPIntM masks the UsbOVPInt interrupt in the Int0 register (0x03).<br>0 = Masked<br>1 = Not masked     |                 |          |                |               |                    |                     |                |
| UsbOkIntM       | UsbOkIntM masks the UsbOkInt interrupt in the Int0 register (0x03).<br>0 = Masked<br>1 = Not masked       |                 |          |                |               |                    |                     |                |
| ChgJEITASDIntM  | ChgThmSDIntM masks the ChgThmSDInt interrupt in the Int0 register (0x03).<br>0 = Masked<br>1 = Not masked |                 |          |                |               |                    |                     |                |
| ChgJEITARegIntM | ThmRegIntM masks the ThmRegInt interrupt in the Int0 register (0x03).<br>0 = Masked<br>1 = Not masked     |                 |          |                |               |                    |                     |                |
| ChgTmoIntM      | ChgTmoIntM masks the ChgTmoInt interrupt in the Int0 register (0x03).<br>0 = Masked<br>1 = Not masked     |                 |          |                |               |                    |                     |                |

**Table 16. IntMask1 Register (0x0D)**

|              |   |            |                  |                  |                  |                  |                 |                 |
|--------------|---|------------|------------------|------------------|------------------|------------------|-----------------|-----------------|
| ADDRESS:     | 0x0D  |            |                  |                  |                  |                  |                 |                 |
| MODE:        | Read/Write  |            |                  |                  |                  |                  |                 |                 |
| BIT          | 7   | 6          | 5                | 4                | 3                | 2                | 1               | 0               |
| NAME         | ThmSd<br>IntM   | BstFitIntM | ThmBuck<br>2IntM | ThmBuck<br>1IntM | UVLOLDO<br>2IntM | UVLOLDO<br>1IntM | ThmLDO<br>2IntM | ThmLDO<br>1IntM |
| ThmSdIntM    | ThmSdIntM masks the ThmSdInt interrupt in the Int1 register (0x04).<br>0 = Masked<br>1 = Not masked       |            |                  |                  |                  |                  |                 |                 |
| BstFitIntM   | BstFitIntM masks the BstFitInt interrupt in the Int1 register (0x04).<br>0 = Masked<br>1 = Not masked     |            |                  |                  |                  |                  |                 |                 |
| ThmBuck2IntM | ThmBuck2IntM masks the ThmBuck2Int interrupt in the Int1 register (0x04).<br>0 = Masked<br>1 = Not masked |            |                  |                  |                  |                  |                 |                 |
| ThmBuck1IntM | Masks the ThmBuck1Int interrupt in the Int1 register (0x04).<br>0 = Masked<br>1 = Not masked              |            |                  |                  |                  |                  |                 |                 |
| UVLOLDO2IntM | Masks the UVLOLDO2Int interrupt in the Int1 register (0x04).<br>0 = Masked<br>1 = Not masked              |            |                  |                  |                  |                  |                 |                 |
| UVLOLDO1IntM | Masks the UVLOLDO1Int interrupt in the Int1 register (0x04).<br>0 = Masked<br>1 = Not masked              |            |                  |                  |                  |                  |                 |                 |
| ThmLDO2IntM  | Masks the ThmLDO2Int interrupt in the Int1 register (0x04).<br>0 = Masked<br>1 = Not masked               |            |                  |                  |                  |                  |                 |                 |
| ThmLDO1IntM  | Masks the ThmLDO1Int interrupt in the Int1 register (0x04).<br>0 = Masked<br>1 = Not masked               |            |                  |                  |                  |                  |                 |                 |

**Table 17. IntMask2 Register (0x0E)**

|               |   |                |   |                 |                |                 |                   |                   |
|---------------|---|----------------|---|-----------------|----------------|-----------------|-------------------|-------------------|
| ADDRESS:      | 0x0E  |                |   |                 |                |                 |                   |                   |
| MODE:         | Read/Write  |                |   |                 |                |                 |                   |                   |
| BIT           | 7   | 6              | 5 | 4               | 3              | 2               | 1                 | 0                 |
| NAME          | APCmd<br>RespIntM   | SysErr<br>IntM | — | LRALock<br>IntM | LRAAct<br>IntM | BBstThm<br>IntM | SysBatLim<br>IntM | ChgSys<br>LimIntM |
| APCmdRespIntM | Masks the APCmdRespInt interrupt in the Int2 register (0x05).<br>0 = Masked<br>1 = Not masked |                |   |                 |                |                 |                   |                   |
| SysErrIntM    | Masks the SysErrInt interrupt in the Int2 register (0x05).<br>0 = Masked<br>1 = Not masked    |                |   |                 |                |                 |                   |                   |
| LRALockIntM   | Masks the LRALockInt interrupt in the Int2 register (0x05).<br>0 = Masked<br>1 = Not masked   |                |   |                 |                |                 |                   |                   |
| LRAActIntM    | Masks the LRAActInt interrupt in the Int2 register (0x05).<br>0 = Masked<br>1 = Not masked    |                |   |                 |                |                 |                   |                   |
| BBstThmIntM   | Masks the BBstThmInt interrupt in the Int2 register (0x05).<br>0 = Masked<br>1 = Not masked   |                |   |                 |                |                 |                   |                   |
| SysBatLimIntM | Masks the SysBatLimInt interrupt in the Int2 register (0x05).<br>0 = Masked<br>1 = Not masked |                |   |                 |                |                 |                   |                   |
| ChgSysLimIntM | Masks the ChgSysLimInt interrupt in the Int2 register (0x05).<br>0 = Masked<br>1 = Not masked |                |   |                 |                |                 |                   |                   |

**AP Interface Registers****Table 18. APDataOut0 Register (0x0F)**

|                 |  |   |   |   |   |   |   |   |
|-----------------|--|---|---|---|---|---|---|---|
| ADDRESS:        | 0x0F                                   |   |   |   |   |   |   |   |
| MODE:           | Read/Write                             |   |   |   |   |   |   |   |
| BIT             | 7                                      | 6 | 5 | 4 | 3 | 2 | 1 | 0 |
| NAME            | APDataOut0[7:0]                        |   |   |   |   |   |   |   |
| APDataOut0[7:0] | Data register 0 for AP write commands. |   |   |   |   |   |   |   |

**Table 19. APDataOut1 Register (0x10)**

|                 |  |   |   |   |   |   |   |   |
|-----------------|--|---|---|---|---|---|---|---|
| ADDRESS:        | 0x10                                   |   |   |   |   |   |   |   |
| MODE:           | Read/Write                             |   |   |   |   |   |   |   |
| BIT             | 7                                      | 6 | 5 | 4 | 3 | 2 | 1 | 0 |
| NAME            | APDataOut1[7:0]                        |   |   |   |   |   |   |   |
| APDataOut1[7:0] | Data register 1 for AP write commands. |   |   |   |   |   |   |   |

**Table 20. APDataOut2 Register (0x11)**

|                 |  |   |   |   |   |   |   |   |
|-----------------|--|---|---|---|---|---|---|---|
| ADDRESS:        | 0x11                                   |   |   |   |   |   |   |   |
| MODE:           | Read/Write                             |   |   |   |   |   |   |   |
| BIT             | 7                                      | 6 | 5 | 4 | 3 | 2 | 1 | 0 |
| NAME            | APDataOut2[7:0]                        |   |   |   |   |   |   |   |
| APDataOut2[7:0] | Data register 2 for AP write commands. |   |   |   |   |   |   |   |

**Table 21. APDataOut3 Register (0x12)**

|                 |  |   |   |   |   |   |   |   |
|-----------------|--|---|---|---|---|---|---|---|
| ADDRESS:        | 0x12                                   |   |   |   |   |   |   |   |
| MODE:           | Read/Write                             |   |   |   |   |   |   |   |
| BIT             | 7                                      | 6 | 5 | 4 | 3 | 2 | 1 | 0 |
| NAME            | APDataOut3[7:0]                        |   |   |   |   |   |   |   |
| APDataOut3[7:0] | Data register 3 for AP write commands. |   |   |   |   |   |   |   |

**Table 22. APDataOut4 Register (0x13)**

|                 |  |   |   |   |   |   |   |   |
|-----------------|--|---|---|---|---|---|---|---|
| ADDRESS:        | 0x13                                   |   |   |   |   |   |   |   |
| MODE:           | Read/Write                             |   |   |   |   |   |   |   |
| BIT             | 7                                      | 6 | 5 | 4 | 3 | 2 | 1 | 0 |
| NAME            | APDataOut4[7:0]                        |   |   |   |   |   |   |   |
| APDataOut4[7:0] | Data register 4 for AP write commands. |   |   |   |   |   |   |   |

**Table 23. APDataOut5 Register (0x14)**

|                 |  |   |   |   |   |   |   |   |
|-----------------|--|---|---|---|---|---|---|---|
| ADDRESS:        | 0x14                                   |   |   |   |   |   |   |   |
| MODE:           | Read/Write                             |   |   |   |   |   |   |   |
| BIT             | 7                                      | 6 | 5 | 4 | 3 | 2 | 1 | 0 |
| NAME            | APDataOut5[7:0]                        |   |   |   |   |   |   |   |
| APDataOut5[7:0] | Data register 5 for AP write commands. |   |   |   |   |   |   |   |

**Table 24. APDataOut6 Register (0x15)**

|                 |  |   |   |   |   |   |   |   |
|-----------------|--|---|---|---|---|---|---|---|
| ADDRESS:        | 0x15                                   |   |   |   |   |   |   |   |
| MODE:           | Read/Write                             |   |   |   |   |   |   |   |
| BIT             | 7                                      | 6 | 5 | 4 | 3 | 2 | 1 | 0 |
| NAME            | APDataOut6[7:0]                        |   |   |   |   |   |   |   |
| APDataOut6[7:0] | Data register 6 for AP write commands. |   |   |   |   |   |   |   |

**Table 25. APCmdOut Register (0x17)**

|               |                         |   |   |   |   |   |   |   |
|---------------|-------------------------|---|---|---|---|---|---|---|
| ADDRESS:      | 0x17                    |   |   |   |   |   |   |   |
| MODE:         | Read/Write              |   |   |   |   |   |   |   |
| BIT           | 7                       | 6 | 5 | 4 | 3 | 2 | 1 | 0 |
| NAME          | APCmdOut[7:0]           |   |   |   |   |   |   |   |
| APCmdOut[7:0] | Opcode command register |   |   |   |   |   |   |   |

**Table 26. APResponse Register (0x18)**

|                 |                              |   |   |   |   |   |   |   |
|-----------------|------------------------------|---|---|---|---|---|---|---|
| ADDRESS:        | 0x18                         |   |   |   |   |   |   |   |
| MODE:           | Read Only                    |   |   |   |   |   |   |   |
| BIT             | 7                            | 6 | 5 | 4 | 3 | 2 | 1 | 0 |
| NAME            | APResponse [7:0]             |   |   |   |   |   |   |   |
| APResponse[7:0] | AP command response register |   |   |   |   |   |   |   |

**Table 27. APDataIn0 Register (0x19)**

|                |                                       |   |   |   |   |   |   |   |
|----------------|---------------------------------------|---|---|---|---|---|---|---|
| ADDRESS:       | 0x19                                  |   |   |   |   |   |   |   |
| MODE:          | Read Only                             |   |   |   |   |   |   |   |
| BIT            | 7                                     | 6 | 5 | 4 | 3 | 2 | 1 | 0 |
| NAME           | APDataIn0[7:0]                        |   |   |   |   |   |   |   |
| APDataIn0[7:0] | Data register 0 for AP read commands. |   |   |   |   |   |   |   |

**Table 28. APDataIn1 Register (0x1A)**

|                |                                       |   |   |   |   |   |   |   |
|----------------|---------------------------------------|---|---|---|---|---|---|---|
| ADDRESS:       | 0x1A                                  |   |   |   |   |   |   |   |
| MODE:          | Read Only                             |   |   |   |   |   |   |   |
| BIT            | 7                                     | 6 | 5 | 4 | 3 | 2 | 1 | 0 |
| NAME           | APDataIn1[7:0]                        |   |   |   |   |   |   |   |
| APDataIn1[7:0] | Data register 1 for AP read commands. |   |   |   |   |   |   |   |

**Table 29. APDataIn2 Register (0x1B)**

|                |                                       |   |   |   |   |   |   |   |
|----------------|---------------------------------------|---|---|---|---|---|---|---|
| ADDRESS:       | 0x1B                                  |   |   |   |   |   |   |   |
| MODE:          | Read Only                             |   |   |   |   |   |   |   |
| BIT            | 7                                     | 6 | 5 | 4 | 3 | 2 | 1 | 0 |
| NAME           | APDataIn2[7:0]                        |   |   |   |   |   |   |   |
| APDataIn2[7:0] | Data register 2 for AP read commands. |   |   |   |   |   |   |   |

**Table 30. APDataIn3 Register (0x1C)**

|                |                                       |   |   |   |   |   |   |   |
|----------------|---------------------------------------|---|---|---|---|---|---|---|
| ADDRESS:       | 0x1C                                  |   |   |   |   |   |   |   |
| MODE:          | Read Only                             |   |   |   |   |   |   |   |
| BIT            | 7                                     | 6 | 5 | 4 | 3 | 2 | 1 | 0 |
| NAME           | APDataIn3[7:0]                        |   |   |   |   |   |   |   |
| APDataIn3[7:0] | Data register 3 for AP read commands. |   |   |   |   |   |   |   |

**Table 31. APDataIn4 Register (0x1D)**

|                 |  |   |   |   |   |   |   |   |
|-----------------|--|---|---|---|---|---|---|---|
| ADDRESS:        | 0x1D                                   |   |   |   |   |   |   |   |
| MODE:           | Read Only                              |   |   |   |   |   |   |   |
| BIT             | 7                                      | 6 | 5 | 4 | 3 | 2 | 1 | 0 |
| NAME            | APDataOut4[7:0]                        |   |   |   |   |   |   |   |
| APDataOut4[7:0] | Data register 4 for AP write commands. |   |   |   |   |   |   |   |

**Table 32. APDataIn5 Register (0x1E)**

|                |                                       |   |   |   |   |   |   |   |
|----------------|---------------------------------------|---|---|---|---|---|---|---|
| ADDRESS:       | 0x1E                                  |   |   |   |   |   |   |   |
| MODE:          | Read Only                             |   |   |   |   |   |   |   |
| BIT            | 7                                     | 6 | 5 | 4 | 3 | 2 | 1 | 0 |
| NAME           | APDataIn5[7:0]                        |   |   |   |   |   |   |   |
| APDataIn5[7:0] | Data register 5 for AP read commands. |   |   |   |   |   |   |   |

**Buck1 DVS Registers****Table 33. Buck1I2CDVS Register (0x1F)**

|            |  |   |   |   |   |   |   |                |
|------------|--|---|---|---|---|---|---|----------------|
| ADDRESS:   | 0x1F   |   |   |   |   |   |   |                |
| MODE:      | Read/Write   |   |   |   |   |   |   |                |
| BIT        | 7  | 6 | 5 | 4 | 3 | 2 | 1 | 0              |
| NAME       | —  | — | — | — | — | — | — | Buck1DVS<br>En |
| Buck1DVSEn | Buck1 Alternate Output Voltage Setting 1<br>Sets the Buck1 voltage when MPC1 = 0 and MPC0 = 1. 0.700V to 2.275V, linear scale, increments of 25mV.<br>000000 = 0.700V<br>000001 = 0.725V<br>...<br>111111 = 2.275V |   |   |   |   |   |   |                |



**LDO Direct Register****Table 34. LDODirect Register (0x20)**

|           |  |   |   |   |   |   |               |               |
|-----------|--|---|---|---|---|---|---------------|---------------|
| ADDRESS:  | 0x20   |   |   |   |   |   |               |               |
| MODE:     | Read/Write   |   |   |   |   |   |               |               |
| BIT       | 7  | 6 | 5 | 4 | 3 | 2 | 1             | 0             |
| NAME      | —  | — | — | — | — | — | LDO2Dir<br>En | LDO1Dir<br>En |
| LDO2DirEn | LDO2 Direct Enable. Valid only if LDO2En = 11<br>0 = LDO2 Off<br>1 = LDO2 On |   |   |   |   |   |               |               |
| LDO1DirEn | LDO1 Direct Enable Valid only if LDO1En = 11<br>0 = LDO1 Off<br>1 = LDO1 On  |   |   |   |   |   |               |               |

**MPC Direct Registers****Table 35. MPCDirectWrite Register (0x21)**

|           |   |   |   |           |           |           |           |           |
|-----------|---|---|---|-----------|-----------|-----------|-----------|-----------|
| ADDRESS:  | 0x21  |   |   |           |           |           |           |           |
| MODE:     | Read/Write  |   |   |           |           |           |           |           |
| BIT       | 7   | 6 | 5 | 4         | 3         | 2         | 1         | 0         |
| NAME      | —   | — | — | MPC4Write | MPC3Write | MPC2Write | MPC1Write | MPC0Write |
| MPC4Write | MPC4 Direct Write (returns 0 if MPC is configured as output (GPIO_HiZB = 1))<br>0 = set MPC4 low<br>1 = set MPC4 high |   |   |           |           |           |           |           |
| MPC3Write | MPC3 Direct Write (returns 0 if MPC is configured as output (GPIO_HiZB = 1))<br>0 = set MPC3 low<br>1 = set MPC3 high |   |   |           |           |           |           |           |
| MPC2Write | MPC2 Direct Write (returns 0 if MPC is configured as output (GPIO_HiZB = 1))<br>0 = set MPC2 low<br>1 = set MPC2 high |   |   |           |           |           |           |           |
| MPC1Write | MPC1 Direct Write (returns 0 if MPC is configured as output (GPIO_HiZB = 1))<br>0 = set MPC1 low<br>1 = set MPC1 high |   |   |           |           |           |           |           |
| MPC0Write | MPC0 Direct Write (returns 0 if MPC is configured as output (GPIO_HiZB = 1))<br>0 = set MPC0 low<br>1 = set MPC0 high |   |   |           |           |           |           |           |

**Table 36. MPCDirectRead Register (0x22)**

|          |   |   |   |          |          |          |          |          |
|----------|---|---|---|----------|----------|----------|----------|----------|
| ADDRESS: | 0x22  |   |   |          |          |          |          |          |
| MODE:    | Read Only   |   |   |          |          |          |          |          |
| BIT      | 7   | 6 | 5 | 4        | 3        | 2        | 1        | 0        |
| NAME     | —   | — | — | MPC4Read | MPC3Read | MPC2Read | MPC1Read | MPC0Read |
| MPC4Read | MPC4 Direct Readback<br>0 = MPC4 is low<br>1 = MPC4 is high |   |   |          |          |          |          |          |
| MPC3Read | MPC3 Direct Readback<br>0 = MPC3 is low<br>1 = MPC3 is high |   |   |          |          |          |          |          |
| MPC2Read | MPC2 Direct Readback<br>0 = MPC2 is low<br>1 = MPC2 is high |   |   |          |          |          |          |          |
| MPC1Read | MPC1 Direct Readback<br>0 = MPC1 is low<br>1 = MPC1 is high |   |   |          |          |          |          |          |
| MPC0Read | MPC0 Direct Readback<br>0 = MPC0 is low<br>1 = MPC0 is high |   |   |          |          |          |          |          |

**Table 37. DVSVlt1 Register (0x23)**

|                     |  |   |                    |   |   |   |   |   |
|---------------------|--|---|--------------------|---|---|---|---|---|
| ADDRESS:            | 0x23   |   |                    |   |   |   |   |   |
| MODE:               | Read/Write   |   |                    |   |   |   |   |   |
| BIT                 | 7  | 6 | 5                  | 4 | 3 | 2 | 1 | 0 |
| NAME                | —  | — | Buck1DVSVSet1[5:0] |   |   |   |   |   |
| Buck1DVSV Set1[5:0] | Buck1 Alternate Output Voltage Setting 1<br>Sets the Buck1 voltage when MPC1 = 0 and MPC0 = 1. 0.700V to 2.275V, linear scale, increments of 25mV.<br>000000 = 0.700V<br>000001 = 0.725V<br>...<br>111111 = 2.275V |   |                    |   |   |   |   |   |

**Table 38. DVSVlt2 Register (0x24)**

|                     |  |   |                    |   |   |   |   |   |
|---------------------|--|---|--------------------|---|---|---|---|---|
| ADDRESS:            | 0x24   |   |                    |   |   |   |   |   |
| MODE:               | Read/Write   |   |                    |   |   |   |   |   |
| BIT                 | 7  | 6 | 5                  | 4 | 3 | 2 | 1 | 0 |
| NAME                | —  | — | Buck1DVSVSet2[5:0] |   |   |   |   |   |
| Buck1DVSV Set2[5:0] | Buck1 Alternate Output Voltage Setting 2<br>Sets the Buck1 voltage when MPC1 = 1 and MPC0 = 0. 0.700V to 2.275V, linear scale, increments of 25mV.<br>000000 = 0.700V<br>000001 = 0.725V<br>...<br>111111 = 2.275V |   |                    |   |   |   |   |   |

**Table 39. DVSVlt3 Register (0x25)**

|                        |  |   |                    |   |   |   |   |   |
|------------------------|--|---|--------------------|---|---|---|---|---|
| ADDRESS:               | 0x25   |   |                    |   |   |   |   |   |
| MODE:                  | Read/Write   |   |                    |   |   |   |   |   |
| BIT                    | 7  | 6 | 5                  | 4 | 3 | 2 | 1 | 0 |
| NAME                   | —  | — | Buck1DVSVSet3[5:0] |   |   |   |   |   |
| Buck1DVSV<br>Set3[5:0] | Buck1 Alternate Output Voltage Setting 3<br>Sets the Buck1 voltage when MPC1 = 1 and MPC0 = 1. 0.700V to 2.275V, linear scale, increments of 25mV.<br>000000 = 0.700V<br>000001 = 0.725V<br>...<br>111111 = 2.275V |   |                    |   |   |   |   |   |

**Haptic Braking Registers****Table 40. AutoBrkCfg0 Register (0x26)**

|                       |   |   |   |   |   |                     |                       |            |
|-----------------------|---|---|---|---|---|---------------------|-----------------------|------------|
| ADDRESS:              | 0x26  |   |   |   |   |                     |                       |            |
| MODE:                 | Read/Write  |   |   |   |   |                     |                       |            |
| BIT                   | 7   | 6 | 5 | 4 | 3 | 2                   | 1                     | 0          |
| NAME                  | —   | — | — | — | — | AutoBrk<br>PeakMeas | AutoBrkFtr<br>SatStop | AutoBrkDis |
| AutoBrkPeak<br>Meas   | BEMF Amplitude Detection Sample Points<br>Determines if two or four BEMF sample points are used during automatic braking.<br>0 = Four sample points are used to measure the BEMF amplitude<br>1 = Two sample points are used to measure the BEMF amplitude  |   |   |   |   |                     |                       |            |
| AutoBrkFtrSat<br>Stop | BEMF Zero Crossing Comparator Counter Saturation<br>If enabled, the automatic braking function exits when the counter on the zero crossing comparator is saturated during a braking window within one of the BrkCyc[4:0] half periods.<br>0 = Do not exit braking when the zero crossing comparator counter is saturated<br>1 = Exit braking when the zero crossing comparator counter is saturated |   |   |   |   |                     |                       |            |
| AutoBrkDis            | Automatic Braking Disable<br>0 = Automatic braking enabled<br>1 = Automatic braking disabled  |   |   |   |   |                     |                       |            |

**Table 41. AutoBrkCfg1 Register (0x27)**

|                       |   |   |   |   |                     |   |                      |   |
|-----------------------|---|---|---|---|---------------------|---|----------------------|---|
| ADDRESS:              | 0x27  |   |   |   |                     |   |                      |   |
| MODE:                 | Read/Write  |   |   |   |                     |   |                      |   |
| BIT                   | 7   | 6 | 5 | 4 | 3                   | 2 | 1                    | 0 |
| NAME                  | AutoBrkMeasWdw [3:0]  |   |   |   | AutoBrkMeasTh [1:0] |   | AutoBrkMeasEnd [1:0] |   |
| AutoBrkMeas Wdw [3:0] | BEMF Amplitude Detection Window<br>Duration of BEMF amplitude measurement window during automatic braking. LSB = 128/25.6MHz  |   |   |   |                     |   |                      |   |
| AutoBrkMeas Th [1:0]  | BEMF Amplitude Detection Threshold<br>Threshold for BEMF absolute amplitude measurement during automatic braking.<br>00 = 2.5mV<br>01 = 5.0mV<br>10 = 7.5mV<br>11 = 10.0mV  |   |   |   |                     |   |                      |   |
| AutoBrkMeas End[1:0]  | BEMF Amplitude Detection End Counter<br>Sets the number of consecutive BEMF amplitude detections in which the absolute amplitude of the BEMF must be less than AutoBrkMeasTh[1:0] for more than half of AutoBrkMeasWdw[3:0] in order to stop automatic braking.<br>00 = 1<br>01 = 2<br>10 = 3<br>11 = 4 |   |   |   |                     |   |                      |   |

**Haptic RAM Registers****Table 42. HptRAMAddr Register (0x28)**

|                |   |   |   |   |   |   |   |   |
|----------------|---|---|---|---|---|---|---|---|
| ADDRESS:       | 0x28  |   |   |   |   |   |   |   |
| MODE:          | Read/Write  |   |   |   |   |   |   |   |
| BIT            | 7   | 6 | 5 | 4 | 3 | 2 | 1 | 0 |
| NAME           | HptRAMAdd[7:0]  |   |   |   |   |   |   |   |
| HptRAMAdd[7:0] | RAM address to which haptic pattern data in registers 0x29, 0x2A, 0x2B will be written. |   |   |   |   |   |   |   |

**Table 43. HptRAMDataH Register (0x29)**

|          |            |   |         |   |          |   |   |   |
|----------|------------|---|---------|---|----------|---|---|---|
| ADDRESS: | 0x29       |   |         |   |          |   |   |   |
| MODE:    | Read/Write |   |         |   |          |   |   |   |
| BIT      | 7          | 6 | 5       | 4 | 3        | 2 | 1 | 0 |
| NAME     | nLSx[1:0]  |   | AmpSign |   | Amp[6:2] |   |   |   |

**Table 44. HptRAMDataM Register (0x2A)**

|          |            |   |          |   |   |   |         |   |
|----------|------------|---|----------|---|---|---|---------|---|
| ADDRESS: | 0x2A       |   |          |   |   |   |         |   |
| MODE:    | Read/Write |   |          |   |   |   |         |   |
| BIT      | 7          | 6 | 5        | 4 | 3 | 2 | 1       | 0 |
| NAME     | Amp[1:0]   |   | Dur[4:0] |   |   |   | Wait[4] |   |

**Table 45. HptRAMDataL Register (0x2B)**

|          |            |   |   |   |          |   |   |   |
|----------|------------|---|---|---|----------|---|---|---|
| ADDRESS: | 0x2B       |   |   |   |          |   |   |   |
| MODE:    | Read/Write |   |   |   |          |   |   |   |
| BIT      | 7          | 6 | 5 | 4 | 3        | 2 | 1 | 0 |
| NAME     | Wait[3:0]  |   |   |   | Rpt[3:0] |   |   |   |

**LED Direct Registers****Table 46. LEDStepDirect Register (0x2C)**

|                  |  |          |          |   |                  |                  |               |   |
|------------------|--|----------|----------|---|------------------|------------------|---------------|---|
| ADDRESS:         | 0x2C   |          |          |   |                  |                  |               |   |
| MODE:            | Read/Write   |          |          |   |                  |                  |               |   |
| BIT              | 7  | 6        | 5        | 4 | 3                | 2                | 1             | 0 |
| NAME             | LED2Open   | LED1Open | LED0Open | — | LDO1_<br>MPC2CNT | LDO1_<br>MPC2CNF | LEDIStep[1:0] |   |
| LED2Open         | LED2 Open detection (Read only)<br>0 = $V_{LED2} > V_{LED\_DET}$<br>1 = $V_{LED2} \leq V_{LED\_DET}$ or LED2 disabled  |          |          |   |                  |                  |               |   |
| LED1Open         | LED1 Open detection (Read only)<br>0 = $V_{LED1} > V_{LED\_DET}$<br>1 = $V_{LED1} \leq V_{LED\_DET}$ or LED1 disabled  |          |          |   |                  |                  |               |   |
| LED0Open         | LED0 Open detection (Read only)<br>0 = $V_{LED0} > V_{LED\_DET}$<br>1 = $V_{LED0} \leq V_{LED\_DET}$ or LED0 disabled  |          |          |   |                  |                  |               |   |
| LDO1_<br>MPC2CNT | LDO1/MPC2 Control Bit<br>Enables the LDO1_MPC2CNF functionality for LDO1.<br>0 = MPC2 has no effect on LDO1<br>1 = LDO1_MPC2CNF is valid and MPC2 function is enabled.   |          |          |   |                  |                  |               |   |
| LDO1_<br>MPC2CNF | LDO1/MPC2 Configuration Bit<br>Sets the effect of MPC2 on LDO1 when LDO1_MPC2CNT = 1.<br>0 = MPC2 controls LDO/SW mode of LDO1 (MPC2 Low = LDO mode, MPC2 High = SW mode).<br>1 = MPC2 controls LDO1 Enable (MPC2 Low = LDO1 disabled, MPC2 High = LDO1 enabled in SW mode). |          |          |   |                  |                  |               |   |
| LEDIStep[1:0]    | LED Direct Current Step Register<br>00 = 0.6mA<br>01 = 1.0mA<br>10 = 1.2mA<br>11 = RESERVED  |          |          |   |                  |                  |               |   |

**Table 47. LED0Direct Register (0x2D)**

|               |  |   |   |   |               |   |   |   |
|---------------|--|---|---|---|---------------|---|---|---|
| ADDRESS:      | 0x2D   |   |   |   |               |   |   |   |
| MODE:         | Read/Write   |   |   |   |               |   |   |   |
| BIT           | 7  | 6 | 5 | 4 | 3             | 2 | 1 | 0 |
| NAME          | LED0En[2:0]  |   |   |   | LED0ISet[4:0] |   |   |   |
| LED0En[2:0]   | LED0 Driver Enable<br>000 = Off<br>001 = LED0 On<br>010 = Controlled by internal charger status signal<br>011 = Controlled by MPC0<br>100 = Controlled by MPC1<br>101 = Controlled by MPC2<br>110 = Controlled by MPC3<br>111 = Controlled by MPC4 |   |   |   |               |   |   |   |
| LED0ISet[4:0] | LED0 Direct Step Count<br>LED0 current in mA is given by $(LED0ISet[4:0] + 1) \times LEDIStep[1:0]$<br>0x00 = 0.6mA/1.0mA/1.2mA<br>0x01 = 1.2mA/2.0mA/2.4mA<br>...<br>0x18 = 15mA/25mA/30mA  |   |   |   |               |   |   |   |

**Table 48. LED1Direct Register (0x2E)**

|               |   |   |   |   |               |   |   |   |
|---------------|---|---|---|---|---------------|---|---|---|
| ADDRESS:      | 0x2E  |   |   |   |               |   |   |   |
| MODE:         | Read/Write  |   |   |   |               |   |   |   |
| BIT           | 7   | 6 | 5 | 4 | 3             | 2 | 1 | 0 |
| NAME          | LED1En[2:0]   |   |   |   | LED1ISet[4:0] |   |   |   |
| LED1En[2:0]   | <p>LED1 Driver Enable</p> <p>000 = Off</p> <p>001 = LED1 On</p> <p>010 = Controlled by internal charger status signal</p> <p>011 = Controlled by MPC0</p> <p>100 = Controlled by MPC1</p> <p>101 = Controlled by MPC2</p> <p>110 = Controlled by MPC3</p> <p>111 = Controlled by MPC4</p> |   |   |   |               |   |   |   |
| LED1ISet[4:0] | <p>LED1 Direct Step Count</p> <p>LED1 current in mA is given by <math>(LED1ISet[4:0] + 1) \times LED1Step[1:0]</math></p> <p>0x00 = 0.6mA/1.0mA/1.2mA</p> <p>0x01 = 1.2mA/2.0mA/2.4mA</p> <p>...</p> <p>0x18 = 15mA/25mA/30mA</p>   |   |   |   |               |   |   |   |

**Table 49. LED2Direct Register (0x2F)**

|               |   |   |   |   |               |   |   |   |
|---------------|---|---|---|---|---------------|---|---|---|
| ADDRESS:      | 0x2F  |   |   |   |               |   |   |   |
| MODE:         | Read/Write  |   |   |   |               |   |   |   |
| BIT           | 7   | 6 | 5 | 4 | 3             | 2 | 1 | 0 |
| NAME          | LED2En[2:0]   |   |   |   | LED2ISet[4:0] |   |   |   |
| LED2En[2:0]   | <p>LED2 Driver Enable</p> <p>000 = Off</p> <p>001 = LED2 On</p> <p>010 = Controlled by internal charger status signal</p> <p>011 = Controlled by MPC0</p> <p>100 = Controlled by MPC1</p> <p>101 = Controlled by MPC2</p> <p>110 = Controlled by MPC3</p> <p>111 = Controlled by MPC4</p> |   |   |   |               |   |   |   |
| LED2ISet[4:0] | <p>LED2 Direct Step Count</p> <p>LED2 current in mA is given by <math>(LED2ISet[4:0] + 1) \times LED2Step[1:0]</math></p> <p>0x00 = 0.6mA/1.0mA/1.2mA</p> <p>0x01 = 1.2mA/2.0mA/2.4mA</p> <p>...</p> <p>0x18 = 15mA/25mA/30mA</p>   |   |   |   |               |   |   |   |

**Haptic Direct Registers****Table 50. HptDirect0 Register (0x30)**

|               |   |   |   |   |   |           |                   |                  |
|---------------|---|---|---|---|---|-----------|-------------------|------------------|
| ADDRESS:      | 0x30  |   |   |   |   |           |                   |                  |
| MODE:         | Read/Write  |   |   |   |   |           |                   |                  |
| BIT           | 7   | 6 | 5 | 4 | 3 | 2         | 1                 | 0                |
| NAME          | —   | — | — | — | — | HptOffImp | HptThmProt<br>Dis | HptOCPr<br>otDis |
| HptOffImp     | <p>Haptic Driver Output Off State Impedance</p> <p>0 = When haptic driver is disabled, outputs are strongly shorted to GND through low-side driver FETs.</p> <p>1 = When haptic driver is disabled, outputs are shorted to GND with 15kΩ pull-down.</p>   |   |   |   |   |           |                   |                  |
| HptThmProtDis | <p>Haptic Driver Thermal Protection Disable</p> <p>If HptThmProtDis = 0 and the haptic driver shuts down due to an over temperature condition, SystemError[7:0] = 0x24 is issued and HptLock = 1. See Opcode 0xA8 for restarting the haptic driver</p> <p>0 = Thermal protection enabled. Haptic driver will shut down if <math>T_J \geq 150^\circ\text{C}</math> (typ)</p> <p>1 = Thermal protection disabled.</p>                       |   |   |   |   |           |                   |                  |
| HptOCProtDis  | <p>Haptic Driver Overcurrent Protection Disable</p> <p>If HptOCProtDis = 0 and the haptic driver shuts down due to an overcurrent condition, SystemError[7:0] will equal to one of four codes (0x20-0x23) is issued and HptLock = 1. See Opcode 0xA8 for restarting the haptic driver</p> <p>0 = Overcurrent protection enabled. Haptic driver will shut down if current exceeds 1A (typ)</p> <p>1 = Overcurrent protection disabled.</p> |   |   |   |   |           |                   |                  |

**Table 51. HptDirect1 Register (0x31)**

|                  |   |          |          |                 |   |   |   |   |
|------------------|---|----------|----------|-----------------|---|---|---|---|
| ADDRESS:         | 0x31  |          |          |                 |   |   |   |   |
| MODE:            | Read/Write  |          |          |                 |   |   |   |   |
| BIT              | 7   | 6        | 5        | 4               | 3 | 2 | 1 | 0 |
| NAME             | HptExtTrig  | HptRamEn | HptDrvEn | HptDrvMode[4:0] |   |   |   |   |
| HptExtTrig       | Haptic driver external trigger pattern for ETRG and RAMHPI driver mode (HptDrvMode = 01100, 10010, respectively).<br>0 = No pattern triggered.<br>1 = Vibration triggered   |          |          |                 |   |   |   |   |
| HptRamEn         | Haptic RAM Block Enable<br>0 = RAM disabled.<br>1 = RAM enabled.  |          |          |                 |   |   |   |   |
| HptDrvEn         | Haptic Driver Enable<br>In all modes, the haptic driver must be enabled at the same time or before providing the desired mode in HptDrvMod[4:0]. The HptDrvEn bit must remain set during the vibration. Once vibration finishes, HptDrvMod[4:0] must be set to "00000" before the haptic driver may be disabled via HptDrvEn = 0 for power savings.<br>0 = Haptic driver block disabled.<br>1 = Haptic driver block enabled.  |          |          |                 |   |   |   |   |
| HptDrvMode [4:0] | Haptic Driver Mode Selection<br>00000 = Disable haptic driver<br>00001 = Enable PPWM0 mode and provide amplitude based on PWM duty cycle on MPC0<br>00010 = Enable PPWM1 mode and provide amplitude based on PWM duty cycle on MPC1<br>00011 = Enable PPWM2 mode and provide amplitude based on PWM duty cycle on MPC2<br>00100 = Enable PPWM3 mode and provide amplitude based on PWM duty cycle on MPC3<br>00101 = Enable PPWM4 mode and provide amplitude based on PWM duty cycle on MPC4<br>00110 = Enable RTI2C mode and provide current output amplitude based on the contents of HptRTI2CAmp(0x32)<br>00111 = Enable ETRG0 mode. Provide a pulse on MPC0 to start vibration (See "ETRG Mode" section for details)<br>01000 = Enable ETRG1 mode. Provide a pulse on MPC1 to start vibration (See "ETRG Mode" section for details)<br>01001 = Enable ETRG2 mode. Provide a pulse on MPC2 to start vibration (See "ETRG Mode" section for details)<br>01010 = Enable ETRG3 mode. Provide a pulse on MPC3 to start vibration (See "ETRG Mode" section for details)<br>01011 = Enable ETRG4 mode. Provide a pulse on MPC4 to start vibration (See "ETRG Mode" section for details)<br>01100 = Enable ETRGI mode via I2C. Set HptExtTrg(0x31[7]) bit to start vibration (See "ETRG Mode" section for details)<br>01101 = Enable RAMHP0 mode. Provide a pulse on MPC0 to start vibration (See "RAMHP Mode" section for details)<br>01110 = Enable RAMHP1 mode. Provide a pulse on MPC1 to start vibration (See "RAMHP Mode" section for details)<br>01111 = Enable RAMHP2 mode. Provide a pulse on MPC2 to start vibration (See "RAMHP Mode" section for details)<br>10000 = Enable RAMHP3 mode. Provide a pulse on MPC3 to start vibration (See "RAMHP Mode" section for details)<br>10001 = Enable RAMHP4 mode. Provide a pulse on MPC4 to start vibration (See "RAMHP Mode" section for details)<br>10010 = Enable RAMHPI mode via I2C. Set HptExtTrg(0x31[7]) bit to start vibration (See "RAMHP Mode" section for details) |          |          |                 |   |   |   |   |



**Table 52. HptRTI2CAmp Register (0x32)**

|                      |   |                  |   |   |   |   |   |   |
|----------------------|---|------------------|---|---|---|---|---|---|
| ADDRESS:             | 0x32  |                  |   |   |   |   |   |   |
| MODE:                | Read/Write  |                  |   |   |   |   |   |   |
| BIT                  | 7   | 6                | 5 | 4 | 3 | 2 | 1 | 0 |
| NAME                 | HptRTI2C<br>Sign  | HptRTI2CAmp[6:0] |   |   |   |   |   |   |
| HptRTI2CSign         | Sign of haptic pattern amplitude in RTI2C mode (HptDrvMode = 00110)                 |                  |   |   |   |   |   |   |
| HptRTI2CAmp<br>[6:0] | Amplitude of haptic pattern in RTI2C mode (HptDrvMode = 00110). LSB = $V_{SYS}/128$ |                  |   |   |   |   |   |   |

**Table 53. HptPatRAMAddr Register (0x33)**

|                        |  |   |   |   |   |   |   |   |
|------------------------|--|---|---|---|---|---|---|---|
| ADDRESS:               | 0x33   |   |   |   |   |   |   |   |
| MODE:                  | Read/Write   |   |   |   |   |   |   |   |
| BIT                    | 7  | 6 | 5 | 4 | 3 | 2 | 1 | 0 |
| NAME                   | HptPatRAMAddr[7:0]   |   |   |   |   |   |   |   |
| HptPatRAMAddr<br>[7:0] | Address of first sample in vibration pattern to be run in RAMHP_ mode (HptDrvMode = 01101, 01111, 10000, 10001, 10010) |   |   |   |   |   |   |   |

## AP Command Register Descriptions

### GPIO Config Commands

**Table 54. 0x01 – GPIO\_Config\_Write**

| MODE             | Write  |    |    |          |         |           |          |          |
|------------------|--|----|----|----------|---------|-----------|----------|----------|
| BIT              | B7   | B6 | B5 | B4       | B3      | B2        | B1       | B0       |
| APCmdOut (0x01)  | 0  | 0  | 0  | 0        | 0       | 0         | 0        | 1        |
| APDataOut0       | —  | —  | —  | GPIO0Cmd | GPIO0OD | GPIO0HiZB | GPIO0Res | GPIO0Pup |
| APDataOut1       | —  | —  | —  | GPIO1Cmd | GPIO1OD | GPIO1HiZB | GPIO1Res | GPIO1Pup |
| APDataOut2       | —  | —  | —  | GPIO2Cmd | GPIO2OD | GPIO2HiZB | GPIO2Res | GPIO2Pup |
| APDataOut3       | —  | —  | —  | GPIO3Cmd | GPIO3OD | GPIO3HiZB | GPIO3Res | GPIO3Pup |
| APDataOut4       | —  | —  | —  | GPIO4Cmd | GPIO4OD | GPIO4HiZB | GPIO4Res | GPIO4Pup |
| <b>GPIO_Cmd</b>  | GPIO Output Control<br>Valid only if GPIO_ is configured as output (GPIO_HiZB = 1)<br>0 = MPC_ output controlled by AP command<br>1 = MPC_ output controlled by I <sup>2</sup> C direct register |    |    |          |         |           |          |          |
| <b>GPIO_OD</b>   | GPIO Output Configuration<br>Valid only if GPIO_ is configured as output (GPIO_HiZB = 1)<br>0 = MPC_ is push-pull connected to BK2OUT<br>1 = MPC_ is open drain                                  |    |    |          |         |           |          |          |
| <b>GPIO_HiZB</b> | GPIO Direction<br>0 = MPC_ is Hi-Z. Input buffer enabled<br>1 = MPC_ is not Hi-Z. Output buffer enabled  |    |    |          |         |           |          |          |
| <b>GPIO_Res</b>  | GPIO Resistor Presence<br>Valid only if GPIO_ is configured as input (GPIO_HiZB = 0)<br>0 = Resistor not connected to MPC_<br>1 = Resistor connected to MPC_                                     |    |    |          |         |           |          |          |
| <b>GPIO_Pup</b>  | GPIO Resistor Configuration<br>Valid only if there is a resistor on GPIO_ (GPIO_Res = 1)<br>0 = Pulldown connected to MPC_<br>1 = Pullup to V <sub>CCINT</sub> connected MCP_                    |    |    |          |         |           |          |          |

**Table 55. GPIO\_Config\_Write Response**

| BIT               | B7 | B6 | B5 | B4 | B3 | B2 | B1 | B0 |
|-------------------|----|----|----|----|----|----|----|----|
| APResponse (0x01) | 0  | 0  | 0  | 0  | 0  | 0  | 0  | 1  |

**Table 56. 0x02 – GPIO\_Config\_Read**

| MODE            | Read |    |    |    |    |    |    |    |
|-----------------|------|----|----|----|----|----|----|----|
| BIT             | B7   | B6 | B5 | B4 | B3 | B2 | B1 | B0 |
| APCmdOut (0x02) | 0    | 0  | 0  | 0  | 0  | 0  | 1  | 0  |

**Table 57. GPIO\_Config\_Read Response**

| BIT               | B7 | B6 | B5 | B4       | B3      | B2        | B1       | B0       |
|-------------------|----|----|----|----------|---------|-----------|----------|----------|
| APResponse (0x02) | 0  | 0  | 0  | 0        | 0       | 0         | 1        | 0        |
| APDataIn0         | —  | —  | —  | GPIO0Cmd | GPIO0OD | GPIO0HiZB | GPIO0Res | GPIO0Pup |
| APDataIn1         | —  | —  | —  | GPIO1Cmd | GPIO1OD | GPIO1HiZB | GPIO1Res | GPIO1Pup |
| APDataIn2         | —  | —  | —  | GPIO2Cmd | GPIO2OD | GPIO2HiZB | GPIO2Res | GPIO2Pup |
| APDataIn3         | —  | —  | —  | GPIO3Cmd | GPIO3OD | GPIO3HiZB | GPIO3Res | GPIO3Pup |
| APDataIn4         | —  | —  | —  | GPIO4Cmd | GPIO4OD | GPIO4HiZB | GPIO4Res | GPIO4Pup |

**Table 58. 0x03 – GPIO\_Control\_Write**

| MODE            | Write   |    |    |          |          |          |          |          |
|-----------------|---|----|----|----------|----------|----------|----------|----------|
| BIT             | B7  | B6 | B5 | B4       | B3       | B2       | B1       | B0       |
| APCmdOut (0x03) | 0   | 0  | 0  | 0        | 0        | 0        | 1        | 1        |
| APDataOut0      | —   | —  | —  | GPIO4Out | GPIO3Out | GPIO2Out | GPIO1Out | GPIO0Out |
| GPIO_Out        | Valid only if GPIO_ is configured as output driven by AP Command (GPIO_Cmd = 0)<br>0 = Set GPIO_ LOW<br>1 = Set GPIO_ HIGH (if GPIO_OD = 0)/Hi-Z (if GPIO_OD = 1) |    |    |          |          |          |          |          |

**Table 59. GPIO\_Control\_Write Response**

| BIT               | B7 | B6 | B5 | B4 | B3 | B2 | B1 | B0 |
|-------------------|----|----|----|----|----|----|----|----|
| APResponse (0x03) | 0  | 0  | 0  | 0  | 0  | 0  | 1  | 1  |

**Table 60. 0x04 – GPIO\_Control\_Read**

| MODE            | Read |    |    |    |    |    |    |    |
|-----------------|------|----|----|----|----|----|----|----|
| BIT             | B7   | B6 | B5 | B4 | B3 | B2 | B1 | B0 |
| APCmdOut (0x04) | 0    | 0  | 0  | 0  | 0  | 1  | 0  | 0  |

**Table 61. GPIO\_Control\_Read Response**

| MODE              | Write  |    |    |           |           |           |           |           |
|-------------------|--|----|----|-----------|-----------|-----------|-----------|-----------|
| BIT               | B7   | B6 | B5 | B4        | B3        | B2        | B1        | B0        |
| APResponse (0x04) | 0  | 0  | 0  | 0         | 0         | 1         | 0         | 0         |
| APDataIn0         | —  | —  | —  | GPIO4Out  | GPIO3Out  | GPIO2Out  | GPIO1Out  | GPIO0Out  |
| APDataIn1         | —  | —  | —  | GPIO4Stat | GPIO3Stat | GPIO2Stat | GPIO1Stat | GPIO0Stat |
| GPIO_Stat         | GPIO State<br>0 = GPIO_LOW<br>1 = GPIO_HIGH (if GPIO_Od = 0) / Hi-Z (if GPIO_Od = 1) |    |    |           |           |           |           |           |

**Table 62. 0x06 – MPC\_Config\_Write**

| MODE            | Write |                       |                        |                     |                       |                       |                        |                        |                      |
|-----------------|-------|-----------------------|------------------------|---------------------|-----------------------|-----------------------|------------------------|------------------------|----------------------|
| BIT             | B7    | B6                    | B5                     | B4                  | B3                    | B2                    | B1                     | B0                     |                      |
| APCmdOut (0x06) | 0     | 0                     | 0                      | 0                   | 0                     | 1                     | 1                      | 0                      |                      |
| APDataOut0      | MPC0  | BBstMPC<br>En         | SFOUTM<br>PCEn         | CPMP<br>CEn         | LDO2MP<br>CEn         | LDO1MP<br>CEn         | Buck2MP<br>CEn         | <b>Buck1MP<br/>CEn</b> | BstMP<br>CEn         |
| APDataOut1      | MPC1  | BBstMPC<br>En         | SFOUTM<br>PCEn         | CPMP<br>CEn         | LDO2MP<br>CEn         | LDO1MP<br>CEn         | <b>Buck2MP<br/>CEn</b> | Buck1MP<br>CEn         | BstMP<br>CEn         |
| APDataOut2      | MPC2  | BBstMPC<br>En         | SFOUTM<br>PCEn         | CPMP<br>CEn         | LDO2MP<br>CEn         | <b>LDO1MP<br/>CEn</b> | Buck2MP<br>CEn         | Buck1MP<br>CEn         | BstMP<br>CEn         |
| APDataOut3      | MPC3  | BBstMPC<br>En         | SFOUTM<br>PCEn         | CPMP<br>CEn         | <b>LDO2MP<br/>CEn</b> | LDO1MP<br>CEn         | Buck2MP<br>CEn         | Buck1MP<br>CEn         | BstMP<br>CEn         |
| APDataOut4      | MPC4  | <b>BBstMPC<br/>En</b> | <b>SFOUTM<br/>PCEn</b> | <b>CPMP<br/>CEn</b> | LDO2MP<br>CEn         | LDO1MP<br>CEn         | Buck2MP<br>CEn         | Buck1MP<br>CEn         | <b>BstMP<br/>CEn</b> |

Shaded fields are defaulted to 1 if the corresponding resources contain the following OTP setting:  
 XXXSeq = 111 (controlled by BstEn after 100% of Boot/POR Process Delay Control)  
 XXXEn = 10 (MPC registers control)

**Table 62. 0x06 – MPC\_Config\_Write (continued)**

|            |   |
|------------|---|
| BBstMPCEn  | Buck-Boost Enable Configuration<br>Effective only when BBstSeq = 111 and BBstEn = 10<br>0 = MPC_ has no effect on Buck-boost<br>1 = Buck-boost enabled when MPC_ is high  |
| SFOUTMPCEn | SFOUT LDO Enable Configuration<br>Effective only when SFOUTEn = 10<br>0 = MPC_ has no effect on SFOUT LDO<br>1 = SFOUT LDO enabled when CHGIN is present and MPC_ is high |
| CPMPCEn    | Charge Pump Enable Configuration<br>Effective only when CPSeq = 111 and CPEn = 10<br>0 = MPC_ has no effect on Charge Pump<br>1 = Charge Pump enabled when MPC_ is high   |
| LDO2MPCEn  | LDO2 Enable Configuration<br>Effective only when LDO2Seq = 111 and LDO2En = 10<br>0 = MPC_ has no effect on LDO2<br>1 = LDO2 enabled when MPC_ is high                    |
| LDO1MPCEn  | LDO1 Enable Configuration<br>Effective only when LDO1Seq = 111 and LDO1En = 10<br>0 = MPC_ has no effect on LDO1<br>1 = LDO1 enabled when MPC_ is high                    |
| Buck2MPCEn | Buck2 Enable Configuration<br>Effective only when Buck2Seq = 111 and Buck2En = 10<br>0 = MPC_ has no effect on Buck2<br>1 = Buck2 enabled when MPC_ is high               |
| Buck1MPCEn | Buck1 Enable Configuration<br>Effective only when Buck1Seq = 111 and Buck1En = 10<br>0 = MPC_ has no effect on Buck1<br>1 = Buck1 enabled when MPC_ is high               |
| BstMPCEn   | Boost Enable Configuration<br>Effective only when BstSeq = 111 and BstEn = 10<br>0 = MPC_ has no effect on Boost<br>1 = Boost enabled when MPC_ is high                   |

**Table 63. MPC\_Config\_Write Response**

| BIT               | B7 | B6 | B5 | B4 | B3 | B2 | B1 | B0 |
|-------------------|----|----|----|----|----|----|----|----|
| APResponse (0x06) | 0  | 0  | 0  | 0  | 0  | 1  | 1  | 0  |

**Table 64. 0x07 – MPC\_Config\_Read**

| MODE            | Read |    |    |    |    |    |    |    |
|-----------------|------|----|----|----|----|----|----|----|
| BIT             | B7   | B6 | B5 | B4 | B3 | B2 | B1 | B0 |
| APCmdOut (0x07) | 0    | 0  | 0  | 0  | 0  | 1  | 1  | 1  |

**Table 65. MPC\_Config\_Read Response**

| BIT               |      | B7         | B6          | B5       | B4         | B3         | B2          | B1          | B0        |
|-------------------|------|------------|-------------|----------|------------|------------|-------------|-------------|-----------|
| APResponse (0x07) |      | 0          | 0           | 0        | 0          | 0          | 1           | 1           | 1         |
| APDataIn0         | MPC0 | BBstMPC En | SFOUTM PCEn | CPMP CEn | LDO2MP CEn | LDO1MP CEn | Buck2MP CEn | Buck1MP CEn | BstMP CEn |
| APDataIn1         | MPC1 | BBstMPC En | SFOUTM PCEn | CPMP CEn | LDO2MP CEn | LDO1MP CEn | Buck2MP CEn | Buck1MP CEn | BstMP CEn |
| APDataIn2         | MPC2 | BBstMPC En | SFOUTM PCEn | CPMP CEn | LDO2MP CEn | LDO1MP CEn | Buck2MP CEn | Buck1MP CEn | BstMP CEn |
| APDataIn3         | MPC3 | BBstMPC En | SFOUTM PCEn | CPMP CEn | LDO2MP CEn | LDO1MP CEn | Buck2MP CEn | Buck1MP CEn | BstMP CEn |
| APDataIn4         | MPC4 | BBstMPC En | SFOUTM PCEn | CPMP CEn | LDO2MP CEn | LDO1MP CEn | Buck2MP CEn | Buck1MP CEn | BstMP CEn |

**Input Current Limit Commands**

Note: Registers written using opcodes 0x10, 0x14, 0x16, 0x18, 0x1A, and 0x1C are reset on charger insertion. After receiving a UsbOk interrupt, wait 10ms before writing any data using these opcodes. Failure to wait 10ms may result in the data being overwritten to the default.

**Table 66. 0x10 – InputCurrent\_Config\_Write**

| MODE            | Write  |    |    |                |    |               |    |    |
|-----------------|--|----|----|----------------|----|---------------|----|----|
| BIT             | B7   | B6 | B5 | B4             | B3 | B2            | B1 | B0 |
| APCmdOut (0x10) | 0  | 0  | 0  | 1              | 0  | 0             | 0  | 0  |
| APDataOut0      | —  | —  | —  | ILimBlank[1:0] |    | ILimCntl[2:0] |    |    |
| ILimBlank [1:0] | CHGIN Current Limiter Blanking Time<br>00 = No debounce (allow a few clock cycles for resampling)<br>01 = 0.5ms<br>10 = 1ms<br>11 = 10ms   |    |    |                |    |               |    |    |
| ILimCntl[2:0]   | CHGIN Programmable Input Current Limit<br>(See EC table for details)<br>000 = 50mA<br>001 = 100mA<br>010 = 150mA<br>011 = 200mA<br>100 = 300mA<br>101 = 400mA<br>110 = 500mA<br>111 = 1000mA |    |    |                |    |               |    |    |

**Table 67. InputCurrent\_Config\_Write Response**

| BIT               | B7 | B6 | B5 | B4 | B3 | B2 | B1 | B0 |
|-------------------|----|----|----|----|----|----|----|----|
| APResponse (0x10) | 0  | 0  | 0  | 1  | 0  | 0  | 0  | 0  |

**Table 68. 0x11 – InputCurrent\_Config\_Read**

| MODE            | Read |    |    |    |    |    |    |    |
|-----------------|------|----|----|----|----|----|----|----|
| BIT             | B7   | B6 | B5 | B4 | B3 | B2 | B1 | B0 |
| APCmdOut (0x11) | 0    | 0  | 0  | 1  | 0  | 0  | 0  | 0  |

**Table 69. InputCurrent\_Config\_Read Response**

| BIT               | B7 | B6 | B5 | B4             | B3 | B2            | B1 | B0 |
|-------------------|----|----|----|----------------|----|---------------|----|----|
| APResponse (0x11) | 0  | 0  | 0  | 1              | 0  | 0             | 0  | 0  |
| APDataIn0         | —  | —  | —  | ILimBlank[1:0] |    | ILimCntl[2:0] |    |    |

**Thermal Shutdown Configuration Commands****Table 70. 0x12 – ThermalShutdown\_Config\_Read**

| MODE            | Write  |    |    |    |    |    |               |    |
|-----------------|--|----|----|----|----|----|---------------|----|
| BIT             | B7   | B6 | B5 | B4 | B3 | B2 | B1            | B0 |
| APCmdOut (0x12) | 0  | 0  | 0  | 1  | 0  | 0  | 1             | 0  |
| APDataOut0      | —  | —  | —  | —  | —  | —  | TShdnTmo[1:0] |    |
| TShdnTmo [1:0]  | Thermal Shutdown Retry Timeout Boot sequence only<br>00 = Latch-Off (See <i>Power State</i> diagrams (Figure 1a to Figure 1f) for restart procedure)<br>01 = 500ms<br>10 = 1s<br>11 = 5s |    |    |    |    |    |               |    |

**Table 71. ThermalShutdown\_Config\_Read Response**

|                   | B7 | B6 | B5 | B4 | B3 | B2 | B1 | B0 |
|-------------------|----|----|----|----|----|----|----|----|
| APResponse (0x12) | 0  | 0  | 0  | 1  | 0  | 0  | 1  | 0  |



## Charger Configuration Commands

Table 72. 0x14 – Charger\_Config\_Write

| MODE            | Write  |            |               |    |                |    |              |    |
|-----------------|--|------------|---------------|----|----------------|----|--------------|----|
| BIT             | B7   | B6         | B5            | B4 | B3             | B2 | B1           | B0 |
| APCmdOut (0x14) | 0  | 0          | 0             | 1  | 0              | 1  | 0            | 0  |
| APDataOut0      | —  | —          | MtChgTmr[1:0] |    | FChgTmr[1:0]   |    | PChgTmr[1:0] |    |
| APDataOut1      | —  | VPChg[2:0] |               |    | IPChg[1:0]     |    | ChgDone[1:0] |    |
| APDataOut2      | ChgAuto Stp  | ChgAuto Re | BatReChg[1:0] |    | BatReg[3:0]    |    |              |    |
| APDataOut3      | —  | —          | —             | —  | SysMinVlt[2:0] |    |              |    |
| MtChgTmr[1:0]   | Maintain Charge Timer Setting<br>00 = 0min<br>01 = 15min<br>10 = 30min<br>11 = 60min   |            |               |    |                |    |              |    |
| FChgTmr[1:0]    | Fast Charge Timer Setting<br>00 = 75min<br>01 = 150min<br>10 = 300min<br>11 = 600min   |            |               |    |                |    |              |    |
| PChgTmr[1:0]    | Pre-charge Timer Setting<br>00 = 30min<br>01 = 60min<br>10 = 120min<br>11 = 240min   |            |               |    |                |    |              |    |
| VPChg[2:0]      | Precharge Voltage Threshold Setting<br>000 = 2.1V<br>001 = 2.25V<br>010 = 2.40V<br>011 = 2.55V<br>100 = 2.70V<br>101 = 2.85V<br>110 = 3.00V<br>111 = 3.15V |            |               |    |                |    |              |    |
| IPChg[1:0]      | Precharge Current Setting<br>00 = 0.05 x IFChg<br>01 = 0.1 x IFChg<br>10 = 0.2 x IFChg<br>11 = 0.3 x IFChg   |            |               |    |                |    |              |    |

**Table 72. 0x14 – Charger\_Config\_Write (continued)**

|                |   |
|----------------|---|
| ChgDone[1:0]   | Charge Done Threshold Setting<br>00 = 0.05 x IFChg<br>01 = 0.1 x IFChg<br>10 = 0.2 x IFChg<br>11 = 0.3 x IFChg  |
| ChgAutoStp     | Charger Auto-Stop<br>Controls the transition from Maintain Charger to Maintain Charger Done.<br>0 = Auto-Stop disabled.<br>1 = Auto-Stop enabled.   |
| ChgAutoRe      | Charger Auto-Restart Control<br>0 = Charger remains in maintain charge done even when $V_{BAT}$ is less than charge restart threshold (see Charger state diagram)<br>1 = Charger automatically restarts when $V_{BAT}$ drops below charge restart threshold |
| BatReChg[1:0]  | Recharge Threshold in Relation to BatReg[3:0]<br>00 = BatReg - 70mV<br>01 = BatReg - 120mV<br>10 = BatReg - 170mV<br>11 = BatReg - 220mV  |
| BatReg[3:0]    | Battery Regulation Voltage<br>0000 = 4.05V<br>0001 = 4.10V<br>0010 = 4.15V<br>0011 = 4.20V<br>0100 = 4.25V<br>0101 = 4.30V<br>0110 = 4.35V<br>0111 = 4.40V<br>1000 = 4.45V<br>1001 = 4.5V<br>1010 = 4.55V<br>1011 = 4.6V                                    |
| SysMinVlt[2:0] | System Voltage Minimum Threshold<br>000 : 3.6V<br>001: 3.7V<br>010: 3.8V<br>011: 3.9V<br>100: 4.0V<br>101: 4.1V<br>110: 4.2V<br>111: 4.3V   |

**Table 73. Charger\_Config\_Write Response**

| BIT               | B7 | B6 | B5 | B4 | B3 | B2 | B1 | B0 |
|-------------------|----|----|----|----|----|----|----|----|
| APResponse (0x14) | 0  | 0  | 0  | 1  | 0  | 1  | 0  | 0  |

**Table 74. 0x15 – Charger\_Config\_Read**

| MODE            | Read |    |    |    |    |    |    |    |
|-----------------|------|----|----|----|----|----|----|----|
| BIT             | B7   | B6 | B5 | B4 | B3 | B2 | B1 | B0 |
| APCmdOut (0x15) | 0    | 0  | 0  | 1  | 0  | 1  | 0  | 1  |

**Table 75. Charger\_Config\_Read Response**

| BIT               | B7          | B6         | B5            | B4 | B3             | B2 | B1           | B0 |
|-------------------|-------------|------------|---------------|----|----------------|----|--------------|----|
| APResponse (0x15) | 0           | 0          | 0             | 1  | 0              | 1  | 0            | 1  |
| APDataIn0         | —           | —          | MtChgTmr[1:0] |    | FChgTmr[1:0]   |    | PChgTmr[1:0] |    |
| APDataIn1         | —           | VPChg[2:0] |               |    | IPChg[1:0]     |    | ChgDone[1:0] |    |
| APDataIn2         | ChgAuto Stp | ChgAuto Re | BatReChg[1:0] |    | BatReg[3:0]    |    |              |    |
| APDataIn3         | —           | —          | —             | —  | SysMinVlt[2:0] |    |              |    |

**Table 76. 0x16 – ChargerThermalLimits\_Config\_Write**

| MODE            | Write  |    |    |    |    |    |    |    |
|-----------------|--|----|----|----|----|----|----|----|
| BIT             | B7   | B6 | B5 | B4 | B3 | B2 | B1 | B0 |
| APCmdOut (0x16) | 0  | 0  | 0  | 1  | 0  | 1  | 1  | 0  |
| APDataOut0      | ColdLim[7:0]   |    |    |    |    |    |    |    |
| APDataOut1      | CoolLim[7:0]   |    |    |    |    |    |    |    |
| APDataOut2      | WarmLim[7:0]   |    |    |    |    |    |    |    |
| APDataOut3      | HotLim[7:0]  |    |    |    |    |    |    |    |
| APDataOut4      | Password[15:8]   |    |    |    |    |    |    |    |
| APDataOut5      | Password[7:0]  |    |    |    |    |    |    |    |
| ColdLim[7:0]    | Cold Zone Boundary<br>Defines the falling threshold voltage on THM that defines the cold charging temperature zone. 8-bit value, 1.8V full-scale voltage.  |    |    |    |    |    |    |    |
| CoolLim[7:0]    | Cool Zone Boundary<br>Defines the falling threshold voltage on THM that defines the cool charging temperature zone. 8-bit value, 1.8V full-scale voltage.  |    |    |    |    |    |    |    |
| WarmLim[7:0]    | Warm Zone Boundary<br>Defines the rising threshold voltage on THM that defines the cool charging temperature zone. 8-bit value, 1.8V full-scale voltage.   |    |    |    |    |    |    |    |
| HotLim[7:0]     | Hot Zone Boundary<br>Defines the rising threshold voltage on THM that defines the hot charging temperature zone. 8-bit value, 1.8V full-scale voltage.   |    |    |    |    |    |    |    |
| Password[15:0]  | Thermal Limit Configuration Password<br>If Write-Protect enabled, ChargerThermalLimits can be configured using the following password: 0x1E7A.<br>If Write-Protect enabled, incorrect password will result in SystemError[7:0] = 0x11. |    |    |    |    |    |    |    |

**Table 77. ChargerThermalLimits\_Config\_Write Response**

| BIT               | B7 | B6 | B5 | B4 | B3 | B2 | B1 | B0 |
|-------------------|----|----|----|----|----|----|----|----|
| APResponse (0x16) | 0  | 0  | 0  | 1  | 0  | 1  | 1  | 0  |

**Table 78. 0x17 – ChargerThermalLimits\_Config\_Read**

| MODE            | Read |    |    |    |    |    |    |    |
|-----------------|------|----|----|----|----|----|----|----|
| BIT             | B7   | B6 | B5 | B4 | B3 | B2 | B1 | B0 |
| APCmdOut (0x17) | 0    | 0  | 0  | 1  | 0  | 1  | 1  | 1  |

**Table 79. ChargerThermalLimits\_Config\_Read Response**

| BIT               | B7           | B6 | B5 | B4 | B3 | B2 | B1 | B0 |
|-------------------|--------------|----|----|----|----|----|----|----|
| APResponse (0x17) | 0            | 0  | 0  | 1  | 0  | 1  | 1  | 0  |
| APDataIn0         | ColdLim[7:0] |    |    |    |    |    |    |    |
| APDataIn1         | CoolLim[8:0] |    |    |    |    |    |    |    |
| APDataIn2         | WarmLim[7:0] |    |    |    |    |    |    |    |
| APDataIn3         | HotLim[7:0]  |    |    |    |    |    |    |    |

**Table 80. 0x18 – ChargerThermalReg\_Config\_Write**

| MODE             | Write  |    |    |                 |    |               |    |    |
|------------------|--|----|----|-----------------|----|---------------|----|----|
| BIT              | B7   | B6 | B5 | B4              | B3 | B2            | B1 | B0 |
| APCmdOut (0x18)  | 0  | 0  | 0  | 1               | 1  | 0             | 0  | 0  |
| APDataOut0       | ColdChgEn  | —  | —  | ColdBatReg[1:0] |    | ColdFChg[2:0] |    |    |
| APDataOut1       | CoolChgEn  | —  | —  | CoolBatReg[1:0] |    | CoolFChg[2:0] |    |    |
| APDataOut2       | —  | —  | —  | RoomBatReg[1:0] |    | RoomFChg[2:0] |    |    |
| APDataOut3       | WarmChgEn  | —  | —  | WarmBatReg[1:0] |    | WarmFChg[2:0] |    |    |
| APDataOut4       | HotChgEn   | —  | —  | HotBatReg[1:0]  |    | HotFChg[2:0]  |    |    |
| APDataOut5       | Password[15:8]   |    |    |                 |    |               |    |    |
| APDataOut6       | Password[7:0]  |    |    |                 |    |               |    |    |
| ColdChgEn        | Cold Zone Charger Control<br>Determines if charger is enabled for cold temperature zone.<br>0 = Charging disabled in cold temperature zone.<br>1 = Charging enabled in cold temperature zone.  |    |    |                 |    |               |    |    |
| ColdBatReg [1:0] | Cold Zone Battery Regulation Voltage<br>Sets modified BatReg[3:0] in the cold temperature zone.<br>00 = BatReg-150mV<br>01 = BatReg-100mV<br>10 = BatReg-50mV<br>11 = BatReg   |    |    |                 |    |               |    |    |
| ColdFChg [2:0]   | Cold Zone Fast Charge Current Scaling<br>Sets modified fast charge in the cold temperature zone.<br>000 = 0.2 x IFChg<br>001 = 0.3 x IFChg<br>010 = 0.4 x IFChg<br>011 = 0.5 x IFChg<br>100 = 0.6 x IFChg<br>101 = 0.7 x IFChg<br>110 = 0.8 x IFChg<br>111 = 1.0 x IFChg |    |    |                 |    |               |    |    |

**Table 80. 0x18 – ChargerThermalReg\_Config\_Write (continued)**

|                     |   |
|---------------------|---|
| CoolChgEn           | <p>Cool Zone Charger Control</p> <p>Determines if charger is enabled for cool temperature zone.</p> <p>0 = Charging disabled in cool temperature zone.</p> <p>1 = Charging enabled in cool temperature zone.</p>  |
| CoolBatReg<br>[1:0] | <p>Cool Zone Battery Regulation Voltage</p> <p>Sets modified BatReg[3:0] in the cool temperature zone.</p> <p>00 = BatReg-150mV</p> <p>01 = BatReg-100mV</p> <p>10 = BatReg-50mV</p> <p>11 = BatReg</p>   |
| CoolFChg<br>[2:0]   | <p>Cool Zone Fast Charge Current Scaling</p> <p>Sets modified fast charge in the cool temperature zone.</p> <p>000 = 0.2 x IFChg</p> <p>001 = 0.3 x IFChg</p> <p>010 = 0.4 x IFChg</p> <p>011 = 0.5 x IFChg</p> <p>100 = 0.6 x IFChg</p> <p>101 = 0.7 x IFChg</p> <p>110 = 0.8 x IFChg</p> <p>111 = 1.0 x IFChg</p>     |
| RoomBat<br>Reg[4:3] | <p>Room Zone Battery Regulation Voltage</p> <p>Sets the modified BatReg[3:0] in the room temperature zone.</p> <p>00 = BatReg-150mV</p> <p>01 = BatReg-100mV</p> <p>10 = BatReg-50mV</p> <p>11 = BatReg</p>   |
| RoomFChg<br>[2:0]   | <p>Room Zone Fast Charge Current Scaling</p> <p>Sets the modified fast charge in the room temperature zone.</p> <p>000 = 0.2 x IFChg</p> <p>001 = 0.3 x IFChg</p> <p>010 = 0.4 x IFChg</p> <p>011 = 0.5 x IFChg</p> <p>100 = 0.6 x IFChg</p> <p>101 = 0.7 x IFChg</p> <p>110 = 0.8 x IFChg</p> <p>111 = 1.0 x IFChg</p> |
| WarmChg<br>En       | <p>Warm Zone Charger Control</p> <p>Determines if charger is enabled for warm temperature zone.</p> <p>0 = Charging disabled in warm temperature zone.</p> <p>1 = Charging enabled in warm temperature zone.</p>  |

**Table 80. 0x18 – ChargerThermalReg\_Config\_Write (continued)**

|                     |   |
|---------------------|---|
| WarmBat<br>Reg[1:0] | <p>Warm Zone Battery Regulation Voltage<br/>Sets the modified BatReg[3:0] in the warm temperature zone.</p> <p>00 = BatReg-150mV<br/>01 = BatReg-100mV<br/>10 = BatReg-50mV<br/>11 = BatReg</p>   |
| WarmFChg<br>[2:0]   | <p>Warm Zone Fast Charge Current Scaling<br/>Sets the modified fast charge in the warm temperature zone.</p> <p>000 = 0.2 x IFChg<br/>001 = 0.3 x IFChg<br/>010 = 0.4 x IFChg<br/>011 = 0.5 x IFChg<br/>100 = 0.6 x IFChg<br/>101 = 0.7 x IFChg<br/>110 = 0.8 x IFChg<br/>111 = 1.0 x IFChg</p> |
| HotChgEn            | <p>Hot Zone Charger Control<br/>Determines if charger is enabled for hot temperature zone.</p> <p>0 = Charging disabled in hot temperature zone.<br/>1 = Charging enabled in hot temperature zone.</p>  |
| HotBatReg<br>[1:0]  | <p>Hot Zone Battery Regulation Voltage<br/>Sets the modified BatReg[3:0] in the hot temperature zone.</p> <p>00 = BatReg-150mV<br/>01 = BatReg-100mV<br/>10 = BatReg-50mV<br/>11 = BatReg</p>   |
| HotFChg<br>[2:0]    | <p>Hot Zone Fast Charge Current Scaling<br/>Sets the modified fast charge in the hot temperature zone.</p> <p>000 = 0.2 x IFChg<br/>001 = 0.3 x IFChg<br/>010 = 0.4 x IFChg<br/>011 = 0.5 x IFChg<br/>100 = 0.6 x IFChg<br/>101 = 0.7 x IFChg<br/>110 = 0.8 x IFChg<br/>111 = 1.0 x IFChg</p>   |
| Password<br>[15:0]  | <p>Charger Thermal Limit Configuration Password<br/>If Write protect enabled, ChargerThermalLimits can be configured using the following password: 0x1E7A<br/>If Write Protect enabled, incorrect password will result in System Error 0x11.</p>  |

**Table 81. ChargerThermalReg\_Config\_Write Response**

| BIT               | B7 | B6 | B5 | B4 | B3 | B2 | B1 | B0 |
|-------------------|----|----|----|----|----|----|----|----|
| APResponse (0x18) | 0  | 0  | 0  | 1  | 1  | 0  | 0  | 0  |

**Table 82. 0x19 – ChargerThermalReg\_Config\_Read**

| MODE            | Read |    |    |    |    |    |    |    |
|-----------------|------|----|----|----|----|----|----|----|
| BIT             | B7   | B6 | B5 | B4 | B3 | B2 | B1 | B0 |
| APCmdOut (0x19) | 0    | 0  | 0  | 1  | 1  | 0  | 0  | 1  |

**Table 83. ChargerThermalReg\_Config\_Read Response**

| BIT               | B7        | B6 | B5 | B4              | B3 | B2            | B1 | B0 |
|-------------------|-----------|----|----|-----------------|----|---------------|----|----|
| APResponse (0x19) | 0         | 0  | 0  | 1               | 1  | 0             | 0  | 1  |
| APDataIn0         | ColdChgEn | —  | —  | ColdBatReg[1:0] |    | ColdFChg[2:0] |    |    |
| APDataIn1         | CoolChgEn | —  | —  | CoolBatReg[1:0] |    | CoolFChg[2:0] |    |    |
| APDataIn2         | —         | —  | —  | RoomBatReg[1:0] |    | RoomFChg[2:0] |    |    |
| APDataIn3         | WarmChgEn | —  | —  | WarmBatReg[1:0] |    | WarmFChg[2:0] |    |    |
| APDataIn4         | HotChgEn  | —  | —  | HotBatReg[1:0]  |    | HotFChg[2:0]  |    |    |

**Table 84. 0x1A – Charger\_ControlWrite**

| MODE            | Write   |    |    |    |    |    |       |       |
|-----------------|---|----|----|----|----|----|-------|-------|
| BIT             | B7  | B6 | B5 | B4 | B3 | B2 | B1    | B0    |
| APCmdOut (0x1A) | 0   | 0  | 0  | 1  | 1  | 0  | 1     | 0     |
| APDataOut0      | —   | —  | —  | —  | —  | —  | ThmEn | ChgEn |
| ThmEn           | On/Off Control for Thermal Monitor<br>0 = Thermal monitor disabled<br>1 = Thermal monitor enabled     |    |    |    |    |    |       |       |
| ChgEn           | On/Off Control for Charger (does not affect SYS node).<br>0 = Charger disabled<br>1 = Charger enabled |    |    |    |    |    |       |       |

**Table 85. Charger\_ControlWrite Response**

| BIT               | B7 | B6 | B5 | B4 | B3 | B2 | B1 | B0 |
|-------------------|----|----|----|----|----|----|----|----|
| APResponse (0x1A) | 0  | 0  | 0  | 1  | 1  | 0  | 1  | 0  |



**Table 86. 0x1B – Charger\_ControlRead**

| MODE            | Read |    |    |    |    |    |    |    |
|-----------------|------|----|----|----|----|----|----|----|
| BIT             | B7   | B6 | B5 | B4 | B3 | B2 | B1 | B0 |
| APCmdOut (0x1B) | 0    | 0  | 0  | 1  | 1  | 0  | 1  | 1  |

**Table 87. Charger\_Control\_Read Response**

| BIT               | B7 | B6 | B5 | B4 | B3 | B2 | B1    | B0    |
|-------------------|----|----|----|----|----|----|-------|-------|
| APResponse (0x1B) | 0  | 0  | 0  | 1  | 1  | 0  | 1     | 1     |
| APDataIn0         | —  | —  | —  | —  | —  | —  | ThmEn | ChgEn |

**Table 88. 0x1C – Charger\_ JEITAHyst\_ControlWrite**

| MODE            | Write   |    |    |             |    |    |    |    |  |
|-----------------|---|----|----|-------------|----|----|----|----|--|
| BIT             | B7  | B6 | B5 | B4          | B3 | B2 | B1 | B0 |  |
| APCmdOut (0x1C) | 0   | 0  | 0  | 1           | 1  | 1  | 0  | 0  |  |
| APDataOut0      | JEITAHys En   | —  | —  | JEITAHysLvl |    |    |    |    |  |
| JEITAHys En     | JEITA Hysteresis Control<br>0 = Hysteresis disabled.<br>1 = Hysteresis enabled.   |    |    |             |    |    |    |    |  |
| JEITAHys Lvl    | Amplitude of JEITA Hysteresis (LSB = 0.39%V <sub>DIG</sub> )<br>00001 = 0.39%V <sub>DIG</sub><br>00010 = 0.78%V <sub>DIG</sub><br>...<br>11111 = 12.09%V <sub>DIG</sub> |    |    |             |    |    |    |    |  |

**Table 89. Charger\_ JEITAHyst\_ControlWrite Response**

| BIT               | B7 | B6 | B5 | B4 | B3 | B2 | B1 | B0 |
|-------------------|----|----|----|----|----|----|----|----|
| APResponse (0x1C) | 0  | 0  | 0  | 1  | 1  | 1  | 0  | 0  |

**Table 90. Charger\_ JEITAHyst\_ControlRead**

| MODE            | Read |    |    |    |    |    |    |    |
|-----------------|------|----|----|----|----|----|----|----|
| BIT             | B7   | B6 | B5 | B4 | B3 | B2 | B1 | B0 |
| APCmdOut (0x1D) | 0    | 0  | 0  | 1  | 1  | 1  | 0  | 1  |

**Table 91. Charger\_ JEITAHyst\_ControlRead Response**

| BIT               | B7         | B6 | B5 | B4          | B3 | B2 | B1 | B0 |
|-------------------|------------|----|----|-------------|----|----|----|----|
| APResponse (0x1D) | 0          | 0  | 0  | 1           | 1  | 1  | 0  | 1  |
| APDataIn0         | JEITAHysEn | —  | —  | JEITAHysLvl |    |    |    |    |

## Boost Configuration Commands

Table 92. 0x30 – Bst\_Config\_Write

| MODE            | Write  |    |              |    |              |            |             |             |
|-----------------|--|----|--------------|----|--------------|------------|-------------|-------------|
| BIT             | B7   | B6 | B5           | B4 | B3           | B2         | B1          | B0          |
| APCmdOut (0x30) | 0  | 0  | 1            | 1  | 0            | 0          | 0           | 0           |
| APDataOut0      | —  | —  | —            | —  | —            | —          | BstEn[1:0]  |             |
| APDataOut1      | —  | —  | —            | —  | BstPsvDsc    | BstlAdptEn | BstFastStrt | BstFetScale |
| APDataOut2      | —  | —  | —            | —  | BstlSet[3:0] |            |             |             |
| APDataOut3      | —  | —  | BstVSet[5:0] |    |              |            |             |             |
| BstEn[1:0]      | Boost Enable Configuration (effective only when BstSeq = 111)<br>00 = Disabled<br>01 = Enabled<br>10 = Controlled by MPC_Config_Write command<br>11 = RESERVED   |    |              |    |              |            |             |             |
| BstPsvDsc       | Boost Passive Discharge Control<br>0 = Boost output will be discharged only when entering Off and Hard-Reset modes.<br>1 = Boost output will be discharged only when entering Off and Hard-Reset modes and when BstEn is set to 000. |    |              |    |              |            |             |             |
| BstlAdptEn      | Boost Adaptive Peak Current Control<br>0 = Inductor peak current fixed at the programmed value by means of BstlSet<br>1 = Inductor peak current automatically increased to provide better load regulation                            |    |              |    |              |            |             |             |
| BstFastStrt     | Boost Fast Start Time<br>0 = Time to full current capability during Startup = 100ms<br>1 = Time to full current capability during Startup = 50ms. Precharge with 2x current  |    |              |    |              |            |             |             |
| BstFetScale     | Boost FET Scaling<br>0 = No FET scaling<br>1 = Active boost FET size scaled down by half to optimize efficiency for low inductor peak current settings   |    |              |    |              |            |             |             |
| BstlSet[3:0]    | Boost Nominal inductor Peak Current Setting<br>25mA step resolution<br>0000 = 100mA<br>0001 = 125mA<br>0010 = 150mA<br>....<br>1111 = 475mA  |    |              |    |              |            |             |             |
| BstVSet[5:0]    | Boost Output Voltage Setting<br>Linear scale from 5V to 20V in 250mV increments<br>000000 = 5V<br>000001 = 5.25V<br>...<br>111011 = 19.75V<br>111011 = 20V<br>>111100 = Reserved   |    |              |    |              |            |             |             |

**Table 93. Bst\_Config\_Write Response**

| BIT               | B7 | B6 | B5 | B4 | B3 | B2 | B1 | B0 |
|-------------------|----|----|----|----|----|----|----|----|
| APResponse (0x30) | 0  | 0  | 1  | 1  | 0  | 0  | 0  | 0  |

**Table 94. 0x31 – Bst\_Config\_Read**

| MODE            | Read |    |    |    |    |    |    |    |
|-----------------|------|----|----|----|----|----|----|----|
| BIT             | B7   | B6 | B5 | B4 | B3 | B2 | B1 | B0 |
| APCmdOut (0x31) | 0    | 0  | 1  | 1  | 0  | 0  | 0  | 1  |

**Table 95. Bst\_Config\_Read Response**

| BIT               | B7   | B6 | B5           | B4 | B3           | B2          | B1          | B0          |
|-------------------|--|----|--------------|----|--------------|-------------|-------------|-------------|
| APResponse (0x31) | 0  | 0  | 1            | 1  | 0            | 0           | 0           | 1           |
| APDataIn0         | —  | —  | —            | —  | —            | —           | BstEn[1:0]  |             |
| APDataIn1         | —  | —  | —            | —  | BstPsvDsc    | BstAdptEn   | BstFastStrt | BstFetScale |
| APDataIn2         | —  | —  | —            | —  | BstISet[3:0] |             |             |             |
| APDataIn3         | RESERVED   | —  | BstVSet[5:0] |    |              |             |             |             |
| APDataIn4         | —  | —  | —            | —  | —            | BstSeq[2:0] |             |             |
| BstSeq[2:0]       | Boost Enable Configuration (Read only)<br>000 = Disabled<br>001 = RESERVED<br>010 = Enabled at 0% of Boot/POR Process Delay Control<br>011 = Enabled at 25% of Boot/POR Process Delay Control<br>100 = Enabled at 50% of Boot/POR Process Delay Control<br>101 = RESERVED<br>110 = RESERVED<br>111 = Controlled by Bst1En after 100% of Boot/POR Process Delay Control |    |              |    |              |             |             |             |

**Buck Configuration Commands****Table 96. 0x35 – Buck1\_Config\_Write**

| MODE               | Write   |                 |                  |                 |                 |                  |                   |                 |
|--------------------|---|-----------------|------------------|-----------------|-----------------|------------------|-------------------|-----------------|
| BIT                | B7  | B6              | B5               | B4              | B3              | B2               | B1                | B0              |
| APCmdOut (0x35)    | 0   | 0               | 1                | 1               | 0               | 1                | 0                 | 1               |
| APDataOut0         | —   | Buck1Psv<br>Dsc | Buck1Sft<br>Strt | Buck1Act<br>Dsc | Buck1Low<br>EMI | Buck1IAdpt<br>En | Buck1Fet<br>Scale | Buck1Wait<br>ZC |
| APDataOut1         | —   | —               | Buck1VSet[5:0]   |                 |                 |                  |                   |                 |
| APDataOut2         | —   | —               | Buck1IZCSet[1:0] |                 | Buck1ISet[3:0]  |                  |                   |                 |
| APDataOut3         | —   | —               | —                | —               | —               | —                | Buck1En[1:0]      |                 |
| Buck1Psv<br>Dsc    | Buck1 Passive Discharge Control<br>0 = Buck1 passively discharged only in Hard-Reset<br>1 = Buck1 passively discharged in Hard-Reset or Enable Low  |                 |                  |                 |                 |                  |                   |                 |
| Buck1Sft<br>Strt   | Buck1 Soft Start Time<br>Buck1 has reduced current capability during soft-start<br>0 = 50ms<br>1 = 25ms   |                 |                  |                 |                 |                  |                   |                 |
| Buck1Act<br>DSC    | Buck1 Active Discharge Control<br>0 = Buck1 actively discharged only in Hard-Reset<br>1 = Buck1 actively discharged in Hard-Reset or Enable Low   |                 |                  |                 |                 |                  |                   |                 |
| Buck1Low<br>EMI    | Buck1 Low EMI Mode<br>0 = Normal operation<br>1 = Increase rise/fall time on BLX by 3x  |                 |                  |                 |                 |                  |                   |                 |
| Buck1IAdpt<br>En   | Buck1 Adaptive Peak Current Mode<br>0 = Inductor peak current fixed at the programmed value by means of Buck1Iset<br>1 = Inductor peak current automatically increased to provide better load regulation  |                 |                  |                 |                 |                  |                   |                 |
| Buck1FET<br>Scale  | Buck1 Force FET Scaling<br>Reduce the FET size by factor 2. Use it to optimize the efficiency for Buck1Iset < 100mA<br>0: FET scaling disabled<br>1: FET scaling enabled  |                 |                  |                 |                 |                  |                   |                 |
| Buck1WaitZC        | Buck1 LX Sense Wait<br>Selects the conditions needed for Buck 1 to enter the freewheeling state. When set to 1, Buck1WaitZC improves efficiency by transferring the residual energy in the inductor in case of positive zero crossing error. Buck1WaitZC should not be set to 1 if Buck1VSet < 1.6V.<br>0 = Buck1 can freewheel at zero-current crossing detection<br>1 = Buck1 can freewheel after the following conditions are met:<br>- inductor zero crossing<br>- BK1LX exceeds 1.6V (max) |                 |                  |                 |                 |                  |                   |                 |
| Buck1VSet<br>[5:0] | Buck1 Output Voltage Setting<br>0.7V to 2.275V, Linear Scale, 25mV increments<br>000000 = 0.7V<br>000001 = 0.725V<br>...<br>111111 = 2.275V   |                 |                  |                 |                 |                  |                   |                 |

**Table 96. 0x35 – Buck1\_Config\_Write (continued)**

|                      |   |
|----------------------|---|
| Buck1IZC<br>Set[1:0] | Buck1 Zero Crossing Current Threshold<br>Optimizes Buck1 for a given voltage setting.<br>00 = 10mA, Use for Buck1VSet < 1V<br>01 = 20mA, Use for 1V < Buck1VSet < 1.8V<br>10 = 30mA, Use for 1.8V < Buck1VSet < 3V<br>11 = 40mA, Use for Buck1Vset > 3V |
| Buck1ISet<br>[3:0]   | Buck1 Inductor current Peak Current Setting<br>25mA step<br>0000 = 0mA<br>0001 = 25mA<br>1111 = 375mA   |
| Buck1En<br>[1:0]     | Buck1 Enable Configuration (effective only when Buck1Seq == 111)<br>00 = Disabled: BK1OUT not actively discharged unless Hard-Reset/Shutdown/Off mode<br>01 = Enabled<br>10 = Controlled by MPC_ (See MPC_Config_Write)<br>11 = RESERVED                |

**Table 97. Buck1\_Config\_Write Response**

| BIT                  | B7 | B6 | B5 | B4 | B3 | B2 | B1 | B0 |
|----------------------|----|----|----|----|----|----|----|----|
| APResponse<br>(0x35) | 0  | 0  | 1  | 1  | 0  | 1  | 0  | 1  |

**Table 98. 0x36 – Buck1\_Config\_Read**

| MODE               | Read |    |    |    |    |    |    |    |
|--------------------|------|----|----|----|----|----|----|----|
| BIT                | B7   | B6 | B5 | B4 | B3 | B2 | B1 | B0 |
| APCmdOut<br>(0x36) | 0    | 0  | 1  | 1  | 0  | 1  | 1  | 0  |

**Table 99. Buck1\_Config\_Read Response**

| BIT                      | B7   | B6              | B5               | B4              | B3              | B2              | B1                | B0              |
|--------------------------|--|-----------------|------------------|-----------------|-----------------|-----------------|-------------------|-----------------|
| <b>APResponse (0x36)</b> | 0  | 0               | 1                | 1               | 0               | 1               | 1                 | 0               |
| <b>APDataIn0</b>         | —  | Buck1Psv<br>Dsc | Buck1Fast        | Buck1Act<br>Dsc | Buck1Low<br>EMI | Buck1En<br>Fmax | Buck1Fet<br>Scale | Buck1Wait<br>ZC |
| <b>APDataIn1</b>         | —  | —               | Buck1VSet[5:0]   |                 |                 |                 |                   |                 |
| <b>APDataIn2</b>         | —  | —               | Buck1IZCSet[1:0] |                 | Buck1Set[3:0]   |                 |                   |                 |
| <b>APDataIn3</b>         | —  | —               | —                | —               | —               | —               | Buck1En[1:0]      |                 |
| <b>APDataIn4</b>         | —  | —               | —                | —               | —               | Buck1Seq[2:0]   |                   |                 |
| Buck1Seq<br>[2:0]        | Buck1 Enable Configuration (Read only)<br>000 = Disabled<br>001 = Reserved<br>010 = Enabled at 0% of Boot/ POR Process Delay Control<br>011 = Enabled at 25% of Boot/ POR Process Delay Control<br>100 = Enabled at 50% of Boot/ POR Process Delay Control<br>101 = Reserved<br>110 = Reserved<br>111 = Controlled by Buck1En [1:0] after 100% of Boot/POR Process Delay Control |                 |                  |                 |                 |                 |                   |                 |

**Table 100. 0x37 – Buck1\_DVSConfig\_Write**

| MODE                        | Write  |    |                         |      |      |      |      |      |
|-----------------------------|--|----|-------------------------|------|------|------|------|------|
| BIT                         | B7   | B6 | B5                      | B4   | B3   | B2   | B1   | B0   |
| <b>APCmdOut (0x37)</b>      | 0  | 0  | 1                       | 1    | 0    | 1    | 1    | 1    |
| <b>APDataOut0</b>           | —  | —  | Buck1VSet[5:0]          |      |      |      |      |      |
| <b>APDataOut1</b>           | —  | —  | Buck1AlternateVSet[5:0] |      |      |      |      |      |
| <b>APDataOut2</b>           | —  | —  | —                       | MPC4 | MPC3 | MPC2 | MPC1 | MPC0 |
| Buck1VSet<br>[5:0]          | Buck1 Voltage Setting for Dynamic Voltage Scaling Function:<br>This is the voltage set on Buck1 after a positive edge on MPC_.<br>0.7V to 2.275V, Linear Scale, 25mV increments<br>000000 = 0.7V<br>000001 = 0.725V<br>...<br>111111 = 2.275V  |    |                         |      |      |      |      |      |
| Buck1Altern<br>ateVSet[5:0] | Buck1 Alternate Voltage Setting for Dynamic Voltage Scaling Function:<br>This is the voltage set on Buck1 upon writing this command or after a negative edge on MPC_.<br>0.7V to 2.275V, Linear Scale, 25mV increments<br>000000 = 0.7V<br>000001 = 0.725V<br>...<br>111111 = 2.275V |    |                         |      |      |      |      |      |
| MPC_                        | This selects the MPC pin used for alternate voltage function.<br>If an MPC is used for dynamic voltage scaling, all other functions of that MPC are disabled.<br>MPC works on edge, so the static value of MPC does not matter.  |    |                         |      |      |      |      |      |

**Table 101. Buck1\_DVSCfg\_Write Response**

| BIT               | B7 | B6 | B5 | B4 | B3 | B2 | B1 | B0 |
|-------------------|----|----|----|----|----|----|----|----|
| APResponse (0x37) | 0  | 0  | 1  | 1  | 0  | 1  | 1  | 1  |

**Table 102. 0x3A – Buck2\_Config\_Write**

| MODE              | Write   |                 |                  |                 |                 |                  |                   |                 |
|-------------------|---|-----------------|------------------|-----------------|-----------------|------------------|-------------------|-----------------|
| BIT               | B7  | B6              | B5               | B4              | B3              | B2               | B1                | B0              |
| APCmdOut (0x3A)   | 0   | 0               | 1                | 1               | 1               | 0                | 1                 | 0               |
| APDataOut0        | —   | Buck2Psv<br>Dsc | Buck2Sft<br>Strt | Buck2Act<br>Dsc | Buck2Low<br>EMI | Buck2IAdpt<br>En | Buck2Fet<br>Scale | Buck2Wait<br>ZC |
| APDataOut1        | —   | —               | Buck2VSet[5:0]   |                 |                 |                  |                   |                 |
| APDataOut2        | —   | —               | Buck2IZCSet[1:0] |                 | Buck2ISet[3:0]  |                  |                   |                 |
| APDataOut3        | —   | —               | —                | —               | —               | —                | Buck2En[1:0]      |                 |
| Buck2Psv<br>DSC   | Buck2 Passive Discharge Control<br>0 = Buck2 passively discharged only in Hard-Reset<br>1 = Buck2 passively discharged in Hard-Reset or Enable Low  |                 |                  |                 |                 |                  |                   |                 |
| Buck2SftStrt      | Buck2 Soft Start Time<br>Buck2 has reduced current capability during soft-start<br>0 = 50ms<br>1 = 25ms   |                 |                  |                 |                 |                  |                   |                 |
| Buck2Act<br>DSC   | Buck2 Active Discharge Control<br>0 = Buck2 actively discharged only in Hard-Reset<br>1 = Buck2 actively discharged in Hard-Reset or Enable Low   |                 |                  |                 |                 |                  |                   |                 |
| Buck2Low<br>EMI   | Buck2 Low EMI Mode<br>0 = Normal operation<br>1 = Increase rise/fall time on BLX by 3x  |                 |                  |                 |                 |                  |                   |                 |
| Buck2IAdpt<br>En  | Buck2 Adaptive Peak Current Mode<br>0 = Inductor peak current fixed at the programmed value by means of Buck1Iset<br>1 = Inductor peak current automatically increased to provide better load regulation  |                 |                  |                 |                 |                  |                   |                 |
| Buck2FET<br>Scale | Buck2 Force FET Scaling<br>Reduce the FET size by factor 2. Use it to optimize the efficiency for Buck1Iset <100mA<br>0 = FET scaling disabled<br>1 = FET scaling enabled   |                 |                  |                 |                 |                  |                   |                 |
| Buck2WaitZC       | Buck2 LX Sense Wait<br>Selects the conditions needed for Buck2 to enter the freewheeling state. When set to 1, Buck2WaitZC improves efficiency by transferring the residual energy in the inductor in case of positive zero crossing error. Buck2WaitZC should not be set to 1 if Buck2VSet < 1.6V.<br>0 = Buck2 can freewheel at the inductor zero crossing point<br>1 = Buck2 can freewheel after the following conditions are met:<br>- inductor zero crossing<br>- BK2LX exceeds the detection threshold (1.6V (max)) |                 |                  |                 |                 |                  |                   |                 |

**Table 102. 0x3A – Buck2\_Config\_Write (continued)**

|                      |   |
|----------------------|---|
| Buck2VSet<br>[5:0]   | Buck2 Output Voltage Setting<br>0.7V to 3.85V, Linear Scale, 50mV increments<br>000000 = 0.7V<br>000001 = 0.75V<br>...<br>111111 = 3.85V  |
| Buck2IZCSet<br>[1:0] | Buck2 Zero Crossing Current Threshold<br>Optimizes Buck2 for a given voltage setting.<br>00 = 10mA, Use for Buck2VSet < 1V<br>01 = 20mA, Use for 1V < Buck2VSet < 1.8V<br>10 = 30mA, Use for 1.8V < Buck2VSet < 3V<br>11 = 40mA, Use for Buck2Vset > 3V |
| Buck2ISet<br>[3:0]   | Buck2 Inductor Current Peak Current Setting<br>25mA step<br>0000 = 0mA<br>0001 = 25mA<br>1111 = 375mA   |
| Buck2En[1:0]         | Buck2 Enable Configuration (effective only when Buck2Seq == 111)<br>00 = Disabled<br>01 = Enabled<br>10 = Controlled by MPC_Config_Write command<br>11 = Reserved   |

**Table 103. Buck2\_Config\_Write Response**

| BIT                  | B7 | B6 | B5 | B4 | B3 | B2 | B1 | B0 |
|----------------------|----|----|----|----|----|----|----|----|
| APResponse<br>(0x3B) | 0  | 0  | 1  | 1  | 1  | 0  | 1  | 0  |

**Table 104. 0x3B – Buck2\_Config\_Read**

| MODE               | Read |    |    |    |    |    |    |    |
|--------------------|------|----|----|----|----|----|----|----|
| BIT                | B7   | B6 | B5 | B4 | B3 | B2 | B1 | B0 |
| APCmdOut<br>(0x3B) | 0    | 0  | 1  | 1  | 1  | 0  | 1  | 1  |



**Table 105. Buck2\_Config\_Read Response**

| BIT                      | B7   | B6              | B5               | B4              | B3              | B2               | B1                | B0              |
|--------------------------|--|-----------------|------------------|-----------------|-----------------|------------------|-------------------|-----------------|
| <b>APResponse (0x3B)</b> | 0  | 0               | 1                | 1               | 1               | 0                | 1                 | 1               |
| APDataIn0                | —  | Buck2Psv<br>Dsc | Buck2Sft<br>Strt | Buck2Act<br>Dsc | Buck2Low<br>EMI | Buck2IAdpt<br>En | Buck2Fet<br>Scale | Buck2Wait<br>ZC |
| APDataIn1                | —  | —               | Buck2VSet[5:0]   |                 |                 |                  |                   |                 |
| APDataIn2                | —  | —               | Buck2IZCSet[1:0] |                 | Buck2ISet[3:0]  |                  |                   |                 |
| APDataIn3                | —  | —               | —                | —               | —               | —                | Buck2En[1:0]      |                 |
| APDataIn4                | —  | —               | —                | —               | —               | Buck2Seq[2:0]    |                   |                 |
| Buck2Seq<br>[2:0]        | Buck2 Enable Configuration (Read Only)<br>000 = Disabled<br>001 = RESERVED<br>010 = Enabled at 0% of Boot/ POR Process Delay Control<br>011 = Enabled at 25% of Boot/ POR Process Delay Control<br>100 = Enabled at 50% of Boot/ POR Process Delay Control<br>101 = RESERVED<br>110 = RESERVED<br>111 = Controlled by Buck2En [1:0] after 100% of Boot/POR Process Delay Control |                 |                  |                 |                 |                  |                   |                 |

**Table 106. 0x3C – Buck2\_DVSConfig\_Write**

| MODE                        | Write  |    |                         |      |      |      |      |      |
|-----------------------------|--|----|-------------------------|------|------|------|------|------|
| BIT                         | B7   | B6 | B5                      | B4   | B3   | B2   | B1   | B0   |
| <b>APCmdOut (0x3C)</b>      | 0  | 0  | 1                       | 1    | 1    | 1    | 0    | 0    |
| <b>APDataOut0</b>           | —  | —  | Buck2VSet[5:0]          |      |      |      |      |      |
| <b>APDataOut1</b>           | —  | —  | Buck2AlternateVSet[5:0] |      |      |      |      |      |
| <b>APDataOut2</b>           | —  | —  | —                       | MPC4 | MPC3 | MPC2 | MPC1 | MPC0 |
| Buck2VSet<br>[5:0]          | Buck2 Voltage Setting for Dynamic Voltage Scaling Function:<br>This is the voltage set on Buck2 after a positive edge on MPC_<br>0.7V to 3.85V, Linear Scale, 50mV increments<br>000000 = 0.7V<br>000001 = 0.75V<br>...<br>111111 = 3.85V  |    |                         |      |      |      |      |      |
| Buck2Altern<br>ateVSet[5:0] | Buck2 Alternate Voltage Setting for Dynamic Voltage Scaling Function:<br>This is the voltage set on Buck2 upon writing this command or after a negative edge on MPC_<br>0.7V to 3.85V, Linear Scale, 50mV increments<br>000000 = 0.7V<br>000001 = 0.75V<br>...<br>111111 = 3.85V |    |                         |      |      |      |      |      |
| MPC_                        | This selects the MPC pin used for alternate voltage function.<br>If an MPC is used for dynamic voltage scaling, all other functions of that MPC are disabled.<br>MPC works on edge, so the static value of MPC does not matter.  |    |                         |      |      |      |      |      |

**Table 107. Buck2\_DVSConfig\_Write Response**

| BIT               | B7 | B6 | B5 | B4 | B3 | B2 | B1 | B0 |
|-------------------|----|----|----|----|----|----|----|----|
| APResponse (0x3C) | 0  | 0  | 1  | 1  | 1  | 1  | 0  | 0  |

**LDO Configuration Commands****Table 108. 0x40 – LDO1\_Config\_Write**

| MODE              | Write  |    |               |                |                |        |             |    |
|-------------------|--|----|---------------|----------------|----------------|--------|-------------|----|
| BIT               | B7   | B6 | B5            | B4             | B3             | B2     | B1          | B0 |
| APCmdOut (0x40)   | 0  | 1  | 0             | 0              | 0              | 0      | 0           | 0  |
| APDataOut0        | —  | —  | —             | LDO1Pas<br>Dsc | LDO1Act<br>Dsc | LDO1Md | LDO1En[1:0] |    |
| APDataOut1        | —  | —  | LDO1VSet[5:0] |                |                |        |             |    |
| LDO1Pas<br>Dsc    | LDO1 Passive Discharge Control<br>0 = LDO1 output will be discharged only entering Off and Hard-Reset modes.<br>1 = LDO1 output will be discharged only entering Off and Hard-Reset modes and when the enable is Low   |    |               |                |                |        |             |    |
| LDO1Act<br>Dsc    | LDO1 Active Discharge Control<br>0 = LDO1 output will be actively discharged only in Hard-Reset mode<br>1 = LDO1 output will be actively discharged in Hard-Reset mode and also when its Enable goes Low   |    |               |                |                |        |             |    |
| LDO1Md            | LDO1 Mode Control<br>When FET is On, the output is unregulated. This setting is internally latched and can change only when the LDO is disabled.<br>0 = Normal LDO operating mode<br>1 = Load switch mode. FET is either fully On or Off depending on state of LDO1En. |    |               |                |                |        |             |    |
| LDO1En<br>[1:0]   | LDO1 Enable Configuration (effective only when LDO1Seq[2:0] == 111)<br>00 = Disabled<br>01 = Enabled<br>10 = Controlled by MPC_Config_Write command<br>11 = Controlled by LDODirect register   |    |               |                |                |        |             |    |
| LDO1VSet<br>[5:0] | LDO1 Output Voltage Setting—Limited by input supply<br>0.5V to 1.95V, Linear Scale, 25mV increments<br>000000 = 0.5V<br>000001 = 0.525V<br>...<br>111010 = 1.95V<br>>111010 = Limited by input supply  |    |               |                |                |        |             |    |

**Table 109. LDO1\_Config\_Write Response**

| BIT               | B7 | B6 | B5 | B4 | B3 | B2 | B1 | B0 |
|-------------------|----|----|----|----|----|----|----|----|
| APResponse (0x40) | 0  | 1  | 0  | 0  | 0  | 0  | 0  | 0  |

**Table 110. 0x41 – LDO1\_Config\_Read**

| MODE            | Read |    |    |    |    |    |    |    |
|-----------------|------|----|----|----|----|----|----|----|
| BIT             | B7   | B6 | B5 | B4 | B3 | B2 | B1 | B0 |
| APCmdOut (0x41) | 0    | 1  | 0  | 0  | 0  | 0  | 0  | 1  |

**Table 111. LDO1\_Config\_Read Response**

| BIT               | B7  | B6 | B5 | B4             | B3             | B2           | B1          | B0 |
|-------------------|---|----|----|----------------|----------------|--------------|-------------|----|
| APResponse (0x41) | 0   | 1  | 0  | 0              | 0              | 0            | 0           | 1  |
| APDataIn0         | —   | —  | —  | LDO1Pas<br>Dsc | LDO1Act<br>Dsc | LDO1Md       | LDO1En[1:0] |    |
| APDataIn1         | —   | —  | —  | LDO1VSet[4:0]  |                |              |             |    |
| APDataIn2         | —   | —  | —  | —              | —              | LDO1Seq[2:0] |             |    |
| LDO1Seq [2:0]     | LDO1 Enable Configuration (Read only)<br>000 = Disabled<br>001 = RESERVED<br>010 = Enabled at 0% of Boot/POR Process Delay Control<br>011 = Enabled at 25% of Boot/POR Process Delay Control<br>100 = Enabled at 50% of Boot/POR Process Delay Control<br>101 = RESERVED<br>110 = RESERVED<br>111 = Controlled by LDO1En [1:0] after 100% of Boot/POR Process Delay Control |    |    |                |                |              |             |    |

**Table 112. 0x42 – LDO2\_Config\_Write**

| MODE                | Write   |    |    |                |                |        |             |    |
|---------------------|---|----|----|----------------|----------------|--------|-------------|----|
| BIT                 | B7  | B6 | B5 | B4             | B3             | B2     | B1          | B0 |
| APCmdOut<br>(0x42)) | 0   | 1  | 0  | 0              | 0              | 0      | 1           | 0  |
| APDataOut0          | —   | —  | —  | LDO2Pas<br>Dsc | LDO2Act<br>Dsc | LDO2Md | LDO2En[1:0] |    |
| APDataOut1          | —   | —  | —  | LDO2VSet[4:0]  |                |        |             |    |
| LDO2Pas<br>Dsc      | LDO2 Passive Discharge Control<br>0 = LDO2 output will be discharged only entering Off and Hard-Reset modes.<br>1 = LDO2 output will be discharged only entering Off and Hard-Reset modes and when the enable is low.   |    |    |                |                |        |             |    |
| LDO2Act<br>Dsc      | LDO2 Active Discharge Control<br>0 = LDO2 output will be actively discharged only in Hard-Reset mode<br>1 = LDO2 output will be actively discharged in Hard-Reset mode and also when its Enable goes Low  |    |    |                |                |        |             |    |
| LDO2Md              | LDO2 Mode Control<br>When FET is On, the output is unregulated. This setting is internally latched and can change only when the LDO2 is disabled.<br>0 = Normal LDO2 operating mode<br>1 = Load switch mode. FET is either fully On or Off depending on state of LDO2En |    |    |                |                |        |             |    |
| LDO2En<br>[1:0]     | LDO2 Enable Configuration (effective only when LDO2Seq[2:0] == 111)<br>00 = Disabled<br>01 = Enabled<br>10 = Controlled by MPC_Config_Write command<br>11 = Controlled by LDODirect register  |    |    |                |                |        |             |    |
| LDO2VSet<br>[4:0]   | LDO2 Output Voltage Setting—Limited by input supply<br>0.9V to 4V, Linear Scale, 100mV increments<br>000000 = 0.9V<br>000001 = 1V<br>...<br>111110 = 3.9V<br>111111 = 4V  |    |    |                |                |        |             |    |

**Table 113. LDO2\_Config\_Write Response**

| BIT               | B7 | B6 | B5 | B4 | B3 | B2 | B1 | B0 |
|-------------------|----|----|----|----|----|----|----|----|
| APResponse (0x42) | 0  | 1  | 0  | 0  | 0  | 0  | 1  | 0  |

**Table 114. 0x43 – LDO2\_Config\_Read**

| MODE            | Read |    |    |    |    |    |    |    |
|-----------------|------|----|----|----|----|----|----|----|
| BIT             | B7   | B6 | B5 | B4 | B3 | B2 | B1 | B0 |
| APCmdOut (0x43) | 0    | 1  | 0  | 0  | 0  | 0  | 1  | 1  |

**Table 115. LDO2\_Config\_Read Response**

| BIT               | B7   | B6 | B5 | B4             | B3             | B2           | B1          | B0 |
|-------------------|--|----|----|----------------|----------------|--------------|-------------|----|
| APResponse (0x43) | 0  | 1  | 0  | 0              | 0              | 0            | 1           | 1  |
| APDataIn0         | —  | —  | —  | LDO2Pas<br>Dsc | LDO2Act<br>Dsc | LDO2Md       | LDO2En[1:0] |    |
| APDataIn1         | —  | —  | —  | LDO2VSet[4:0]  |                |              |             |    |
| APDataIn2         | —  | —  | —  | —              | —              | LDO2Seq[2:0] |             |    |
| LDO2Seq [2:0]     | LDO2 Enable Configuration (Read only)<br>000 = Disabled<br>001 = Enabled always when BAT/SYS is present<br>010 = Enabled at 0% of Boot/ POR Process Delay Control<br>011 = Enabled at 25% of Boot/ POR Process Delay Control<br>100 = Enabled at 50% of Boot/ POR Process Delay Control<br>101 = RESERVED<br>110 = RESERVED<br>111 = Controlled by LDO2En [1:0] after 100% of Boot/POR Process Delay Control |    |    |                |                |              |             |    |

**Charge Pump Configuration Commands****Table 116. 0x46 – ChargePump\_Config\_Write**

| MODE            | Write   |    |    |    |    |    |            |        |
|-----------------|---|----|----|----|----|----|------------|--------|
| BIT             | B7  | B6 | B5 | B4 | B3 | B2 | B1         | B0     |
| APCmdOut (0x46) | 0   | 1  | 0  | 0  | 0  | 1  | 1          | 0      |
| APDataOut0      | —   | —  | —  | —  | —  | —  | CPEn[1:0]  |        |
| APDataOut1      | —   | —  | —  | —  | —  | —  | CPPscDisch | CPVSet |
| CPEn[1:0]       | Charge Pump Enable Configuration (effective only when CPSeq = 111)<br>00 = Disabled<br>01 = Enabled<br>10 = Controlled by MPC_Config_Write command<br>11 = RESERVED |    |    |    |    |    |            |        |
| CPpsvDisch      | Charge Pump Passive Discharge Enable<br>0 = Disabled<br>1 = Enabled   |    |    |    |    |    |            |        |
| CPVSet          | 0 = 6.6V<br>1 = 5V  |    |    |    |    |    |            |        |

**Table 117. ChargePump\_Config\_Write Response**

| BIT               | B7 | B6 | B5 | B4 | B3 | B2 | B1 | B0 |
|-------------------|----|----|----|----|----|----|----|----|
| APResponse (0x46) | 0  | 1  | 0  | 0  | 0  | 1  | 1  | 0  |

**Table 118. 0x47 – ChargePump\_Config\_Read**

| MODE            | Read |    |    |    |    |    |    |    |
|-----------------|------|----|----|----|----|----|----|----|
| BIT             | B7   | B6 | B5 | B4 | B3 | B2 | B1 | B0 |
| APCmdOut (0x47) | 0    | 1  | 0  | 0  | 0  | 1  | 1  | 1  |

**Table 119. ChargePump\_Config\_Read Response**

| BIT               | B7   | B6 | B5 | B4 | B3 | B2         | B1         | B0     |
|-------------------|--|----|----|----|----|------------|------------|--------|
| APResponse (0x47) | 0  | 1  | 0  | 0  | 0  | 1          | 1          | 1      |
| APDataIn0         | —  | —  | —  | —  | —  | —          | CPEn[1:0]  |        |
| APDataIn1         | —  | —  | —  | —  | —  | —          | CPPscDisch | CPVSet |
| APDataIn2         | —  | —  | —  | —  | —  | CPSeq[2:0] |            |        |
| CPSeq[2:0]        | Charge Pump Enable Configuration (Read only)<br>000 = Disabled<br>001 = RESERVED<br>010 = Enabled at 0% of Boot/POR Process Delay Control<br>011 = Enabled at 25% of Boot/POR Process Delay Control<br>100 = Enabled at 50% of Boot/POR Process Delay Control<br>101 = RESERVED<br>110 = RESERVED<br>111 = Controlled by CPEn after 100% of Boot/POR Process Delay Control |    |    |    |    |            |            |        |

**SFOUT Configuration Commands****Table 120. 0x48 – SFOUT\_Config\_Write**

| MODE            | Write   |    |    |    |    |            |              |    |
|-----------------|---|----|----|----|----|------------|--------------|----|
| BIT             | B7  | B6 | B5 | B4 | B3 | B2         | B1           | B0 |
| APCmdOut (0x48) | 0   | 1  | 0  | 0  | 1  | 0          | 0            | 0  |
| APDataOut0      | —   | —  | —  | —  | —  | SFOUTV Set | SFOUTEn[1:0] |    |
| SFOUTV Set      | SFOUT Output Voltage Setting<br>0 = 5V<br>1 = 3.3V  |    |    |    |    |            |              |    |
| SFOUTE n[1:0]   | SFOUT LDO Enable Configuration<br>00 = Disabled (regardless of CHGIN)<br>01 = Enabled when CHGIN is present<br>10 = Enabled when CHGIN is present and Controlled by MPC_Config_Write command<br>11 = RESERVED |    |    |    |    |            |              |    |

**Table 121. SFOUT\_Config\_Write Response**

| BIT               | B7 | B6 | B5 | B4 | B3 | B2 | B1 | B0 |
|-------------------|----|----|----|----|----|----|----|----|
| APResponse (0x48) | 0  | 1  | 0  | 0  | 1  | 0  | 0  | 0  |

**Table 122. 0x49 – SFOUT\_Config\_Read**

| MODE            | Read |    |    |    |    |    |    |    |
|-----------------|------|----|----|----|----|----|----|----|
| BIT             | B7   | B6 | B5 | B4 | B3 | B2 | B1 | B0 |
| APCmdOut (0x49) | 0    | 1  | 0  | 0  | 1  | 0  | 0  | 1  |

**Table 123. SFOUT\_Config\_Read Response**

| BIT               | B7 | B6 | B5 | B4 | B3 | B2        | B1           | B0 |
|-------------------|----|----|----|----|----|-----------|--------------|----|
| APResponse (0x49) | 0  | 1  | 0  | 0  | 1  | 0         | 0            | 1  |
| APDataIn0         | —  | —  | —  | —  | —  | SFOUTVSet | SFOUTEn[1:0] |    |



**MON Mux Configuration Commands****Table 124. 0x50 – MONMux\_Config\_Write**

| MODE                     | Write  |    |        |                  |    |              |    |    |
|--------------------------|--|----|--------|------------------|----|--------------|----|----|
| BIT                      | B7   | B6 | B5     | B4               | B3 | B2           | B1 | B0 |
| APCmdOut (0x50)          | 0  | 1  | 0      | 1                | 0  | 0            | 0  | 0  |
| APDataOut0               | MONEn  | —  | MONHiZ | MONRatioCfg[1:0] |    | MONCtrl[2:0] |    |    |
| <b>MONEn</b>             | Enable Signal For MON Mux<br>0 = MON is not connected to any internal node and its state depends on MONHiZ<br>1 = MON is connected based on MONCtrl[2:0] configuration   |    |        |                  |    |              |    |    |
| <b>MONHiZ</b>            | MON Off Mode Condition<br>0 = Pulled LOW by 59kΩ pulldown resistor<br>1 = Hi-Z   |    |        |                  |    |              |    |    |
| <b>MONRatio Cfg[1:0]</b> | MON Resistive Partition Selector<br>00 = 1:1<br>01 = 2:1<br>10 = 3:1<br>11 = 4:1   |    |        |                  |    |              |    |    |
| <b>MONCtrl[2:0]</b>      | MON Pin Source Selection (80μs BBM after any change of MONCtrl[2:0])<br>000 = MON connected to a resistive partition of BAT<br>001 = MON connected to a resistive partition of SYS<br>010 = MON connected to a resistive partition of BK2OUT<br>011 = MON connected to a resistive partition of BK1OUT<br>100 = MON connected to a resistive partition of L2OUT<br>101 = MON connected to a resistive partition of L1OUT<br>110 = MON connected to a resistive partition of SFOUT<br>111 = MON connected to a resistive partition of BBOUT |    |        |                  |    |              |    |    |

**Table 125. MONMux\_Config\_Write Response**

| BIT               | B7 | B6 | B5 | B4 | B3 | B2 | B1 | B0 |
|-------------------|----|----|----|----|----|----|----|----|
| APResponse (0x51) | 0  | 1  | 0  | 1  | 0  | 0  | 0  | 0  |

**Table 126. 0x51 – MONMux\_Config\_Read**

| MODE            | Read |    |    |    |    |    |    |    |
|-----------------|------|----|----|----|----|----|----|----|
| BIT             | B7   | B6 | B5 | B4 | B3 | B2 | B1 | B0 |
| APCmdOut (0x51) | 0    | 1  | 0  | 1  | 0  | 0  | 0  | 1  |

**Table 127. MONMux\_Config\_Read Response**

| BIT               | B7    | B6 | B5     | B4               | B3 | B2           | B1 | B0 |
|-------------------|-------|----|--------|------------------|----|--------------|----|----|
| APResponse (0x51) | 0     | 1  | 0      | 1                | 0  | 0            | 0  | 1  |
| APDataIn0         | MONEN | —  | MONHiZ | MONRatioCfg[1:0] |    | MONCtrl[2:0] |    |    |

**Table 128. 0x53 – ADC\_Measure\_Launch**

| MODE            | Launch   |    |                |    |    |             |    |    |
|-----------------|--|----|----------------|----|----|-------------|----|----|
| BIT             | B7   | B6 | B5             | B4 | B3 | B2          | B1 | B0 |
| APCmdOut (0x53) | 0  | 1  | 0              | 1  | 0  | 0           | 1  | 1  |
| APDataOut0      | —  | —  | ADCAvgSiz[2:0] |    |    | ADCSel[2:0] |    |    |
| ADCAvgSiz[2:0]  | ADC Averaging Size<br>ADC performs $2^{\text{ADCAvgSiz}[2:0]}$ consecutive averaged measurements                             |    |                |    |    |             |    |    |
| ADCSel[2:0]     | ADC Channel Selection<br>000 = SYS<br>001 = MON<br>010 = THM<br>011 = CHGIN<br>100 = CPOUT<br>101 = BSTOUT<br>11x = RESERVED |    |                |    |    |             |    |    |

**Table 129. ADC\_Measure\_Launch Response**

| BIT               | B7  | B6 | B5 | B4 | B3 | B2 | B1             | B0 |
|-------------------|---|----|----|----|----|----|----------------|----|
| APResponse (0x53) | 0   | 1  | 0  | 1  | 0  | 0  | 1              | 1  |
| APDataIn0         | —   | —  | —  | —  | —  | —  | ADCResult[1:0] |    |
| APDataIn1         | ADCMax[7:0]   |    |    |    |    |    |                |    |
| APDataIn2         | ADCMin[7:0]   |    |    |    |    |    |                |    |
| APDataIn3         | ADCAvg[7:0]   |    |    |    |    |    |                |    |
| ADCResult         | ADC Result Ready<br>00 = Success, measurement completed<br>01 = ADC busy<br>10 = ADC measurement aborted by Haptic Automatic Level Compensation engine<br>11 = RESERVED |    |    |    |    |    |                |    |
| ADCMax[7:0]       | ADC Maximum Value<br>Contains the maximum value measured by the ADC   |    |    |    |    |    |                |    |
| ADCMin[7:0]       | ADC Minimum Value<br>Contains the minimum value measured by the ADC   |    |    |    |    |    |                |    |
| ADCAvg[7:0]       | ADC Average Value<br>Contains the average value of $2^{\text{ADCAvgSiz}[2:0]}$ ADC measurements   |    |    |    |    |    |                |    |

**Buck-Boost Configuration Commands****Table 130. 0x70 – BBst\_Config\_Write**

| MODE            | Write   |             |               |             |        |               |             |    |
|-----------------|---|-------------|---------------|-------------|--------|---------------|-------------|----|
| BIT             | B7  | B6          | B5            | B4          | B3     | B2            | B1          | B0 |
| APCmdOut (0x70) | 0   | 1           | 1             | 1           | 0      | 0             | 0           | 0  |
| APDataOut0      | RESERVED (Set to 0x00)  |             |               |             |        |               |             |    |
| APDataOut1      | —   | —           | —             | —           | —      | BBstlSet[2:0] |             |    |
| APDataOut2      | —   | —           | BBstVSet[4:0] |             |        |               |             |    |
| APDataOut3      | —   | BBstRip Red | BBstAct Dsc   | BBstPas Dsc | BBstMd | BBstlnd       | BBstEn[1:0] |    |
| BBstlSet [2:0]  | Buck-Boost Peak Current Limit Setting<br>000 = 0 (Minimum On-time)<br>001 = 50mA<br>010 = 100mA<br>011 = 150mA<br>100 = 200mA<br>101 = 250mA<br>110 = 300mA<br>111 = 350mA  |             |               |             |        |               |             |    |
| BBstVSet [4:0]  | Buck-Boost Output Voltage Setting This setting is internally latched and can change only when Buck-Boost is Disabled.<br>2.5V to 5.0V, Linear Scale, 100mV increments<br>000000 = 2.5V<br>000001 = 2.6V<br>...<br>011001 = 5.0V<br>>011001 = 5.0V |             |               |             |        |               |             |    |
| BBstRip Red     | Buck-Boost Ripple Reduction<br>Leave set to 1   |             |               |             |        |               |             |    |
| BBstAct Dsc     | Buck-Boost Active Discharge Control<br>0 = Actively discharged only in Hard-Reset<br>1 = Actively discharged in Hard-Reset or Enable Low  |             |               |             |        |               |             |    |
| BBstPas Dsc     | Buck-Boost Passive Discharge Control<br>0 = Passively discharged only in Hard-Reset<br>1 = Passively discharged in Hard-Reset or Enable Low   |             |               |             |        |               |             |    |

**Table 130. 0x70 – BBst\_Config\_Write (continued)**

|                 |  |
|-----------------|--|
| BBstMd          | Buck-Boost EMI Reduction<br>0 = Damping enabled<br>1 = Damping disabled  |
| BBstInd         | Buck-Boost Inductance select<br>0 = Inductance is 4.7μH<br>1 = Inductance is 3.3μH   |
| BBstEn<br>[1:0] | Buck-Boost Enable Configuration (effective only when BBstSeq[2:0] == 111)<br>00 = Disabled<br>01 = Enabled<br>10 = Controlled by MPC_Config_Write command<br>11 = RESERVED |

**Table 131. BBst\_Config\_Write Response**

| BIT                  | B7 | B6 | B5 | B4 | B3 | B2 | B1 | B0 |
|----------------------|----|----|----|----|----|----|----|----|
| APResponse<br>(0x70) | 0  | 1  | 1  | 1  | 0  | 0  | 0  | 0  |

**Table 132. 0x71 – BBst\_Config\_Read**

| MODE               | Read |    |    |    |    |    |    |    |
|--------------------|------|----|----|----|----|----|----|----|
| BIT                | B7   | B6 | B5 | B4 | B3 | B2 | B1 | B0 |
| APCmdOut<br>(0x71) | 0    | 1  | 1  | 1  | 0  | 0  | 0  | 1  |

**Table 133. BBst\_Config\_Read Response**

| BIT                  | B7   | B6             | B5         | B4            | B3     | B2            | B1          | B0 |
|----------------------|--|----------------|------------|---------------|--------|---------------|-------------|----|
| APResponse<br>(0x71) | 0  | 1              | 1          | 1             | 0      | 0             | 0           | 1  |
| APDataIn0            | ClkDiv<br>Ena  | ClkDivSet[6:0] |            |               |        |               |             |    |
| APDataIn1            | —  | —              | —          | —             | —      | BBstISet[2:0] |             |    |
| APDataIn2            | —  | —              | —          | BBstVSet[4:0] |        |               |             |    |
| APDataIn3            | —  | —              | BBstActDsc | BBstPasDsc    | BBstMd | BBstInd       | BBstEn[1:0] |    |
| APDataIn4            | —  | —              | —          | —             | —      | BBstSeq[2:0]  |             |    |
| BBstSeq<br>[2:0]     | Buck-Boost Enable Configuration (Read only)<br>000 = Disabled<br>001 = RESERVED<br>010 = Enabled at 0% of Boot/ POR Process Delay Control<br>011 = Enabled at 25% of Boot/ POR Process Delay Control<br>100 = Enabled at 50% of Boot/ POR Process Delay Control<br>101 = RESERVED<br>110 = RESERVED<br>111 = Controlled by BBstEn [1:0] after 100% of Boot/POR Process Delay Control |                |            |               |        |               |             |    |

## Haptic Configuration Commands

Table 134. 0xA0 – Hpt\_Config\_Write0

| MODE            | Write  |    |                |             |              |        |        |          |
|-----------------|--|----|----------------|-------------|--------------|--------|--------|----------|
| BIT             | B7   | B6 | B5             | B4          | B3           | B2     | B1     | B0       |
| APCmdOut (0xA0) | 1  | 0  | 1              | 0           | 0            | 0      | 0      | 0        |
| APDataOut0      | —  | —  | —              | —           | EmfEn        | HptSel | AlcMod | ZccHysEn |
| APDataOut1      | IniGss[7:0]  |    |                |             |              |        |        |          |
| APDataOut2      | ZccSlow En   | —  | —              | FltrCntrEn  | IniGss[11:8] |        |        |          |
| APDataOut3      | —  | —  | —              | IniDly[4:0] |              |        |        |          |
| APDataOut4      | —  | —  | IniGssRes Dis  | WidWdw[4:0] |              |        |        |          |
| APDataOut5      | —  | —  | BrkLpGain[1:0] |             | NarWdw[3:0]  |        |        |          |
| EmfEn           | Back EMF and Resonance Detection Control<br>Can also be set using opcode 0xAD.<br>0 = Disabled<br>1 = Enabled  |    |                |             |              |        |        |          |
| HptSel          | Haptic Mode Select<br>Can also be set using opcode 0xAD.<br>0 = ERM Mode<br>1 = LRA Mode   |    |                |             |              |        |        |          |
| AlcMod          | Automatic Level Compensation (ALC) Control<br>Can also be set using opcode 0xAD.<br>0 = Disabled<br>1 = Enabled  |    |                |             |              |        |        |          |
| ZccHysEn        | Zero-Crossing Comparator Hysteresis Control<br>Can also be set using opcode 0xAD<br>0 = Disabled<br>1 = Enabled (6mV typ).   |    |                |             |              |        |        |          |
| IniGss [11:0]   | Back EMF Initial Guess<br>Can also be set using opcode 0xAE.<br>Initial estimate for BEMF frequency = ((25.6MHz/64) / IniGss[11:0])  |    |                |             |              |        |        |          |
| ZccSlowEn       | Zero-Crossing Comparator Slow-Down Enable<br>Can also be set using opcode 0xBA.<br>0 = Zero-crossing comparator operates in normal mode.<br>1 = Slows down the zero-crossing comparator by 2X for stronger antialiasing filtering. |    |                |             |              |        |        |          |

**Table 134. 0xA0 – Hpt\_Config\_Write0 (continued)**

|                 |   |
|-----------------|---|
| FtrCntrEn       | Zero-Crossing Event Capturing Filter Enable<br>Can also be set using opcode 0xBA<br>0 = Zero-crossing measured using single comparator/transition.<br>1 = Zero-crossing measured using an up/down counter (samples at 25.6MHz). Samples the output of the comparator for the whole duration of the enabled window (wide, narrow, or braking). The counter starts at zero (mid-code) and will end at a positive or negative code depending on whether the average zero-crossing event occurs before or after than the expected time. The closer the zero-crossing is on average to the expected time, the closer to zero code returned at the end of the window will be. Phase error (in 25.6MHz period units) can be calculated by dividing the resulting code at the end of the window by 2. The usage of the up/down counter enables filtering/noise rejection that could otherwise cause a systematic shift in the phase error detected. |
| IniDly[4:0]     | Number of sine wave periods to be skipped before (re)starting BEMF measurement after:<br>Start of vibration pattern.<br>Change of output polarity (e.g., braking)<br>Programmed percentage output amplitude (w.r.t. $V_{FS}$ ) becomes again higher than EmfSkipTh[6:0] after having previously gone below it. Can also be set using Opcode 0xAF.   |
| IniGssResDis    | Disable Initial Guess Restore<br>0 = Haptic driver uses IniGss[11:0] as the driving frequency after the end of BrkCyc[4:0] sinewave half periods.<br>1 = Haptic driver does not use IniGss[11:0] as the driving frequency after the end of BrkCyc[4:0] sine wave half periods.<br>Can also be set using opcode 0xB0.  |
| WidWdw [4:0]    | Wide window duration for BEMF zero-crossing detection LSB = $1/32^{nd}$ of currently imposed sinewave period.<br>Can also be set using Opcode 0xB0  |
| BrkLpGain [1:0] | Braking Window Gain<br>Sets gain by which the phase delay found by the zero-crossing comparator is multiplied to calculate the shift for the new sine wave half period with respect to the previously imposed sine wave. This value is used when the braking window is active.<br>Can also be set using opcode 0xB0.<br>00 = 1<br>01 = 1/2<br>10 = 1/4<br>11 = 1/8  |
| NarWdw [3:0]    | Narrow window duration for BEMF zero-crossing detection LSB = $1/32^{nd}$ of currently imposed sinewave period.<br>Can also be set using Opcode 0xB0  |

**Table 135. Hpt\_Config\_Write0 Response**

| BIT               | B7 | B6 | B5 | B4 | B3 | B2 | B1 | B0 |
|-------------------|----|----|----|----|----|----|----|----|
| APResponse (0xA0) | 1  | 0  | 1  | 0  | 0  | 0  | 0  | 0  |

**Table 136. 0xA1 – Hpt\_Config\_Read0**

| MODE            | Read |    |    |    |    |    |    |    |
|-----------------|------|----|----|----|----|----|----|----|
| BIT             | B7   | B6 | B5 | B4 | B3 | B2 | B1 | B0 |
| APCmdOut (0xA1) | 1    | 0  | 1  | 0  | 0  | 0  | 0  | 1  |

Table 137. Hpt\_Config\_Read0 Response

| BIT               | B7          | B6 | B5             | B4          | B3           | B2     | B1     | B0       |
|-------------------|-------------|----|----------------|-------------|--------------|--------|--------|----------|
| APResponse (0xA1) | 1           | 0  | 1              | 0           | 0            | 0      | 0      | 1        |
| APDataIn0         | —           | —  | —              | —           | EmfEn        | HptSel | AlcMod | ZccHysEn |
| APDataIn1         | IniGss[7:0] |    |                |             |              |        |        |          |
| APDataIn2         | ZccSlow En  | —  | —              | FltrCntrEn  | IniGss[11:8] |        |        |          |
| APDataIn3         | —           | —  | —              | IniDly[4:0] |              |        |        |          |
| APDataIn4         | —           | —  | IniGssRes Dis  | WidWdw[4:0] |              |        |        |          |
| APDataIn5         | —           | —  | BrkLpGain[1:0] |             | NarWdw[3:0]  |        |        |          |

Table 138. 0xA2 – Hpt\_Config\_Write1

| MODE             | Write   |    |    |             |                 |               |    |    |
|------------------|---|----|----|-------------|-----------------|---------------|----|----|
| BIT              | B7  | B6 | B5 | B4          | B3              | B2            | B1 | B0 |
| APCmdOut (0xA2)  | 1   | 0  | 1  | 0           | 0               | 0             | 1  | 0  |
| APDataOut0       | BrkCyc[4:0]   |    |    |             | EmfSkipCyc[2:0] |               |    |    |
| APDataOut1       | BlankWdw[2:0]   |    |    | BrkWdw[4:0] |                 |               |    |    |
| APDataOut2       | —   | —  | —  | —           | —               | BlankWdw[5:3] |    |    |
| APDataOut3       | HptVfs[7:0]   |    |    |             |                 |               |    |    |
| APDataOut4       | ETRGdAmp[7:0]   |    |    |             |                 |               |    |    |
| APDataOut5       | ETRGdDur [7:0]  |    |    |             |                 |               |    |    |
| BrkCyc[4:0]      | Sets the number of consecutive sine wave half periods during which active braking is applied after a change in driving polarity. During these half periods, the gain used becomes BrkLpGain[1:0], the window duration becomes BrkWdw[4:0], and the effects of IniDly[4:0], EmfSkipCyc[2:0], and NarCntLck[5:0] are masked. Can also be set using opcode 0xB1. |    |    |             |                 |               |    |    |
| EmfSkipCyc [2:0] | Sets number of consecutive sine wave half periods during which BEMF detection is skipped after a BEMF detection completes. Can also be set using opcode 0xB1.   |    |    |             |                 |               |    |    |
| BlankWdw [5:0]   | Zero-crossing comparator blanking time applied after entering or prior to exiting the wide, narrow, and braking windows. The blanking window duration cannot exceed 1/64 <sup>th</sup> of the current sine wave period unless AutoBrkPeakMeas = 1 and the driver is in the automatic braking state. LSB = 128/25.6MHz. Can also be set using opcode 0xB9.     |    |    |             |                 |               |    |    |
| BrkWdw[4:0]      | Braking window duration for BEMF zero-crossing detection. LSB = 1/32 <sup>nd</sup> of current sine wave period. Can also be set using opcode 0xB9.  |    |    |             |                 |               |    |    |
| HptVfs[7:0]      | Stores the full-scale voltage ( $V_{FS}$ ) to which the desired percentage output amplitude is referred. The actual $V_{FS}$ will be the minimum between the value programmed on HptVfs[7:0] and the current SYS value. LSB = 21.57mV. Can also be set using opcode 0xB2.   |    |    |             |                 |               |    |    |
| ETRGdAmp[7:0]    | Sets amplitude of the overdrive period as a percentage of $V_{FS}$ (ETRG mode). LSB = 0.78% $V_{FS}$ . Note that the MSB represents the sign of the amplitude to be driven. Can also be set using opcode 0xB3.  |    |    |             |                 |               |    |    |
| ETRGdDur [7:0]   | Sets duration of the overdrive period. LSB = 5ms. Can also be set using opcode 0xB3. (ETRG mode)  |    |    |             |                 |               |    |    |

**Table 139. Hpt\_Config\_Write1 Response**

| BIT               | B7 | B6 | B5 | B4 | B3 | B2 | B1 | B0 |
|-------------------|----|----|----|----|----|----|----|----|
| APResponse (0xA2) | 1  | 0  | 1  | 0  | 0  | 0  | 1  | 0  |

**Table 140. 0xA3 – Hpt\_Config\_Read1**

| MODE            | Write |    |    |    |    |    |    |    |
|-----------------|-------|----|----|----|----|----|----|----|
| BIT             | B7    | B6 | B5 | B4 | B3 | B2 | B1 | B0 |
| APCmdOut (0xA3) | 1     | 0  | 1  | 0  | 0  | 0  | 1  | 1  |

**Table 141. Hpt\_Config\_Read1 Response**

| BIT               | B7             | B6 | B5 | B4          | B3              | B2            | B1 | B0 |
|-------------------|----------------|----|----|-------------|-----------------|---------------|----|----|
| APResponse (0xA3) | 1              | 0  | 1  | 0           | 0               | 0             | 1  | 1  |
| APDataIn0         | BrkCyc[4:0]    |    |    |             | EmfSkipCyc[2:0] |               |    |    |
| APDataIn1         | BlankWdw[2:0]  |    |    | BrkWdw[4:0] |                 |               |    |    |
| APDataIn2         | —              | —  | —  | —           | —               | BlankWdw[5:3] |    |    |
| APDataIn3         | HptVfs[7:0]    |    |    |             |                 |               |    |    |
| APDataIn4         | ETRGdAmp[7:0]  |    |    |             |                 |               |    |    |
| APDataIn5         | ETRGdDur [7:0] |    |    |             |                 |               |    |    |



Table 142. 0xA4— Hpt\_Config\_Write2

| MODE            | Write  |                |                |    |    |                |    |    |
|-----------------|--|----------------|----------------|----|----|----------------|----|----|
| BIT             | B7   | B6             | B5             | B4 | B3 | B2             | B1 | B0 |
| APCmdOut (0xA4) | 1  | 0              | 1              | 0  | 0  | 1              | 0  | 0  |
| APDataOut0      | ETRActAmp[7:0]   |                |                |    |    |                |    |    |
| APDataOut1      | ETRActDur[7:0]   |                |                |    |    |                |    |    |
| APDataOut2      | ETRBrkAmp[7:0]   |                |                |    |    |                |    |    |
| APDataOut3      | ETRBrkAmp[7:0]   |                |                |    |    |                |    |    |
| APDataOut4      | —  | NarLpGain[2:0] |                |    | —  | WidLpGain[2:0] |    |    |
| APDataOut5      | —  | —              | NarCntLck[5:0] |    |    |                |    |    |
| ETRActAmp[7:0]  | Sets amplitude of the normal drive period as a percentage of $V_{FS}$ (ETR mode). LSB = $0.78\%V_{FS}$ plus sign bit. Can also be set using opcode 0xB3.   |                |                |    |    |                |    |    |
| ETRActDur[7:0]  | Sets duration of the normal drive period. LSB = 10ms (ETR mode). Can also be set using opcode 0xB3.  |                |                |    |    |                |    |    |
| ETRBrkAmp[7:0]  | Sets amplitude of the braking period as a percentage of $V_{FS}$ (ETR mode). Triggers the automatic braking process with a maximum braking time of ETRBrkDur[7:0]. LSB = $0.78\%V_{FS}$ plus sign bit. Can also be set using opcode 0xB3.  |                |                |    |    |                |    |    |
| ETRBrkDur[7:0]  | Sets duration of the braking period. LSB = 5ms (ETR mode). Can also be set using opcode 0xB3.  |                |                |    |    |                |    |    |
| NarLpGain [2:0] | Sets gain by which the phase delay found by the zero-crossing comparator is multiplied to calculate the shift for the new sinewave half period with respect to the previously imposed sinewave. This value is used when the narrow window is active. Can also be set using opcode 0xB4.<br>000 = 1<br>001 = 1/2<br>010 = 1/4<br>011 = 1/8<br>100 = 1/16<br>101 = 1/32<br>110 = 1/64<br>111 = 1/128 |                |                |    |    |                |    |    |
| WidLpGain [2:0] | Sets gain by which the phase delay found by the zero-crossing comparator is multiplied to calculate the shift for the new sinewave half period with respect to the previously imposed sinewave. This value is used when the wide window is active. Can also be set using opcode 0xB4.<br>000 = 1<br>001 = 1/2<br>010 = 1/4<br>011 = 1/8<br>100 = 1/16<br>101 = 1/32<br>110 = 1/64<br>111 = 1/128   |                |                |    |    |                |    |    |
| NarCntLck [5:0] | Sets number of consecutive sinewave half periods where the BEMF is detected and where the phase delay must fall within the narrow window before detection window is reduced from wide to narrow. Can also be set using opcode 0xB5.  |                |                |    |    |                |    |    |

**Table 143. Hpt\_Config\_Write2 Response**

| BIT               | B7 | B6 | B5 | B4 | B3 | B2 | B1 | B0 |
|-------------------|----|----|----|----|----|----|----|----|
| APResponse (0xA4) | 1  | 0  | 1  | 0  | 0  | 1  | 0  | 0  |

**Table 144. 0xA5 – Hpt\_Config\_Read2**

| MODE            | Write |    |    |    |    |    |    |    |
|-----------------|-------|----|----|----|----|----|----|----|
| BIT             | B7    | B6 | B5 | B4 | B3 | B2 | B1 | B0 |
| APCmdOut (0xA5) | 1     | 0  | 1  | 0  | 0  | 1  | 0  | 1  |

**Table 145. Hpt\_Config\_Read2 Response**

| BIT               | B7              | B6             | B5             | B4 | B3 | B2             | B1 | B0 |
|-------------------|-----------------|----------------|----------------|----|----|----------------|----|----|
| APResponse (0xA5) | 1               | 0              | 1              | 0  | 0  | 1              | 0  | 1  |
| APDataIn0         | ETRGActAmp[7:0] |                |                |    |    |                |    |    |
| APDataIn1         | ETRGActDur[7:0] |                |                |    |    |                |    |    |
| APDataIn2         | ETRGBrkAmp[7:0] |                |                |    |    |                |    |    |
| APDataIn3         | ETRGBrkAmp[7:0] |                |                |    |    |                |    |    |
| APDataIn4         | —               | NarLpGain[2:0] |                |    | —  | WidLpGain[2:0] |    |    |
| APDataIn5         | —               | —              | NarCntLck[5:0] |    |    |                |    |    |

**Table 146. 0xA6 – Hpt\_SYS\_Threshold\_Config\_Write**

| MODE             | Write  |    |    |    |    |    |    |    |
|------------------|--|----|----|----|----|----|----|----|
| BIT              | B7   | B6 | B5 | B4 | B3 | B2 | B1 | B0 |
| APCmdOut (0xA6)  | 1  | 0  | 1  | 0  | 0  | 1  | 1  | 0  |
| APDataOut0       | HptSysUVLO[7:0]  |    |    |    |    |    |    |    |
| HptSys UVLO[7:0] | Haptic SYS UVLO Threshold<br>Sets the SYS undervoltage threshold. If $V_{SYS}$ falls below this UVLO threshold, the haptic driver is locked (HptLock = 1) and System-Error[7:0] = 0x25 is issued. See Opcode 0xA8 for details on restarting the haptic driver.<br>LSB = 5.5V/255 |    |    |    |    |    |    |    |

**Table 147. Hpt\_SYS\_threshold\_Config\_Write Response**

| BIT               | B7 | B6 | B5 | B4 | B3 | B2 | B1 | B0 |
|-------------------|----|----|----|----|----|----|----|----|
| APResponse (0xA6) | 1  | 0  | 1  | 0  | 0  | 1  | 1  | 0  |

**Table 148. 0xA7—Hpt\_SYS\_threshold\_Config\_Read**

| MODE            | Read |    |    |    |    |    |    |    |
|-----------------|------|----|----|----|----|----|----|----|
| BIT             | B7   | B6 | B5 | B4 | B3 | B2 | B1 | B0 |
| APCmdOut (0xA7) | 1    | 0  | 1  | 0  | 0  | 1  | 1  | 1  |

**Table 149. Hpt\_SYS\_threshold\_Config\_Read Response**

| BIT               | B7              | B6 | B5 | B4 | B3 | B2 | B1 | B0 |
|-------------------|-----------------|----|----|----|----|----|----|----|
| APResponse (0xA7) | 1               | 0  | 1  | 0  | 0  | 1  | 1  | 1  |
| APDataIn0         | HptSysUVLO[7:0] |    |    |    |    |    |    |    |

**Table 150. 0xA8 – Hpt\_Lock\_Config\_Write**

| MODE            | Write   |    |    |    |    |    |    |         |
|-----------------|---|----|----|----|----|----|----|---------|
| BIT             | B7  | B6 | B5 | B4 | B3 | B2 | B1 | B0      |
| APCmdOut (0xA8) | 1   | 0  | 1  | 0  | 1  | 0  | 0  | 0       |
| APDataOut0      | —   | —  | —  | —  | —  | —  | —  | HptLock |
| HptLock         | Haptic Driver Lock<br>When a fault condition causes the haptic driver to lock, this bit can only be cleared by manually writing HptLock = 0 to opcode 0xA8. The haptic driver output will be off while HptLock = 1.<br>0 = Unlock Haptic Driver<br>1 = Lock Haptic Driver |    |    |    |    |    |    |         |

**Table 151. Hpt\_Lock\_Config\_Write Response**

| BIT               | B7 | B6 | B5 | B4 | B3 | B2 | B1 | B0 |
|-------------------|----|----|----|----|----|----|----|----|
| APResponse (0xA8) | 1  | 0  | 1  | 0  | 1  | 0  | 0  | 0  |

**Table 152. 0xA9 – Hpt\_Lock\_Config\_Read**

| MODE            | Read |    |    |    |    |    |    |    |
|-----------------|------|----|----|----|----|----|----|----|
| BIT             | B7   | B6 | B5 | B4 | B3 | B2 | B1 | B0 |
| APCmdOut (0xA9) | 1    | 0  | 1  | 0  | 1  | 0  | 0  | 1  |

**Table 153. Hpt\_Lock\_Config\_Read Response**

| BIT               | B7 | B6 | B5 | B4 | B3 | B2 | B1 | B0      |
|-------------------|----|----|----|----|----|----|----|---------|
| APResponse (0xA9) | 1  | 0  | 1  | 0  | 1  | 0  | 0  | 1       |
| APDataIn0         | —  | —  | —  | —  | —  | —  | —  | HptLock |

**Table 154. 0xAA – Hpt\_EMF\_Threshold\_Config\_Write**

| MODE            | Write   |                |    |    |    |    |    |    |
|-----------------|---|----------------|----|----|----|----|----|----|
| BIT             | B7  | B6             | B5 | B4 | B3 | B2 | B1 | B0 |
| APCmdOut (0xAA) | 1   | 0              | 1  | 0  | 1  | 0  | 1  | 0  |
| APDataOut0      | —   | EmfSkipTh[6:0] |    |    |    |    |    |    |
| EMFSkipTh [6:0] | Back EMF Skip Threshold<br>Percentage of the full-scale output amplitude under which to skip the BEMF measurement as the returned BEMF would be too small to measure in these cases. LSB = 0.78%V <sub>FS</sub> . |                |    |    |    |    |    |    |

**Table 155. Hpt\_EMF\_Threshold\_Config\_Write Response**

| BIT               | B7 | B6 | B5 | B4 | B3 | B2 | B1 | B0 |
|-------------------|----|----|----|----|----|----|----|----|
| APResponse (0xAA) | 1  | 0  | 1  | 0  | 1  | 0  | 1  | 0  |

**Table 156. 0xAB – Hpt\_EMF\_Threshold\_Config\_Read**

| MODE            | Read |    |    |    |    |    |    |    |
|-----------------|------|----|----|----|----|----|----|----|
| BIT             | B7   | B6 | B5 | B4 | B3 | B2 | B1 | B0 |
| APCmdOut (0xAB) | 1    | 0  | 1  | 0  | 1  | 0  | 1  | 1  |

**Table 157. HPT\_EMF\_Threshold\_Config\_Read Response**

| BIT               | B7 | B6 | B5 | B4 | B3             | B2 | B1 | B0 |
|-------------------|----|----|----|----|----------------|----|----|----|
| APResponse (0xAB) | 1  | 0  | 1  | 0  | 1              | 0  | 1  | 1  |
| APDataIn0         | —  |    |    |    | EmfSkipTh[6:0] |    |    |    |

**Table 158. 0xAC—HPT\_Autotune**

| MODE            | Launch |    |    |    |    |    |    |    |
|-----------------|--------|----|----|----|----|----|----|----|
| BIT             | B7     | B6 | B5 | B4 | B3 | B2 | B1 | B0 |
| APCmdOut (0xAC) | 1      | 0  | 1  | 0  | 1  | 1  | 0  | 0  |

**Table 159. HPT\_Autotune Response**

| BIT               | B7   | B6 | B5 | B4 | B3               | B2 | B1 | B0 |
|-------------------|--|----|----|----|------------------|----|----|----|
| APResponse (0xAC) | 1  | 0  | 1  | 0  | 1                | 1  | 0  | 0  |
| APDataIn0         | Result[7:0]  |    |    |    |                  |    |    |    |
| APDataIn1         | BEMFPeriod[7:0]  |    |    |    |                  |    |    |    |
| APDataIn2         | —  | —  | —  | —  | BEMFPeriod[11:8] |    |    |    |
| Result [7:0]      | 0x00 = Auto-tune done, BEMFPeriod[11:0] available.<br>0x01 = Auto-tune failed.                   |    |    |    |                  |    |    |    |
| BEMFPeriod [11:0] | Resonant frequency resolved by autotune function = $((25.6\text{MHz} / 64) / \text{BEMF\_freq})$ |    |    |    |                  |    |    |    |

**Table 160. 0xAD— HPT\_SetMode**

| MODE            | Write |    |    |    |       |        |        |          |
|-----------------|-------|----|----|----|-------|--------|--------|----------|
| BIT             | B7    | B6 | B5 | B4 | B3    | B2     | B1     | B0       |
| APCmdOut (0xAD) | 1     | 0  | 1  | 0  | 1     | 1      | 0      | 1        |
| APDataOut0      | —     | —  | —  | —  | EmfEn | HptSel | AlcMod | ZccHysEn |

**Table 161. HPT\_SetMode Response**

| BIT               | B7 | B6 | B5 | B4 | B3 | B2 | B1 | B0 |
|-------------------|----|----|----|----|----|----|----|----|
| APResponse (0xAD) | 1  | 0  | 1  | 0  | 1  | 1  | 0  | 1  |

**Table 162. 0xAE— HPT\_SetInitialGuess**

| MODE            | Write       |    |    |    |              |    |    |    |
|-----------------|-------------|----|----|----|--------------|----|----|----|
| BIT             | B7          | B6 | B5 | B4 | B3           | B2 | B1 | B0 |
| APCmdOut (0xAE) | 1           | 0  | 1  | 0  | 1            | 1  | 1  | 0  |
| APDataOut0      | IniGss[7:0] |    |    |    |              |    |    |    |
| APDataOut1      | —           | —  | —  | —  | IniGss[11:8] |    |    |    |

**Table 163. HPT\_SetInitialGuess Response**

| BIT               | B7 | B6 | B5 | B4 | B3 | B2 | B1 | B0 |
|-------------------|----|----|----|----|----|----|----|----|
| APResponse (0xAE) | 1  | 0  | 1  | 0  | 1  | 1  | 1  | 0  |

**Table 164. 0xAF— HPT\_SetInitialDelay**

| MODE            | Write |    |    |             |    |    |    |    |  |
|-----------------|-------|----|----|-------------|----|----|----|----|--|
| BIT             | B7    | B6 | B5 | B4          | B3 | B2 | B1 | B0 |  |
| APCmdOut (0xAF) | 1     | 0  | 1  | 0           | 1  | 1  | 1  | 1  |  |
| APDataOut0      | —     | —  | —  | IniDly[4:0] |    |    |    |    |  |

**Table 165. HPT\_SetInitialDelay Response**

| BIT               | B7 | B6 | B5 | B4 | B3 | B2 | B1 | B0 |
|-------------------|----|----|----|----|----|----|----|----|
| APResponse (0xAF) | 1  | 0  | 1  | 0  | 1  | 1  | 1  | 1  |

**Table 166. 0xB0—HPT\_SetWindow**

| MODE            | Write |    |                  |             |             |    |    |    |  |
|-----------------|-------|----|------------------|-------------|-------------|----|----|----|--|
| BIT             | B7    | B6 | B5               | B4          | B3          | B2 | B1 | B0 |  |
| APCmdOut (0xB0) | 1     | 0  | 1                | 1           | 0           | 0  | 0  | 0  |  |
| APDataOut0      | —     | —  | IniGssRes<br>Dis | WidWdw[4:0] |             |    |    |    |  |
| APDataOut1      | —     | —  | BrkLpGain[1:0]   |             | NarWdw[3:0] |    |    |    |  |

**Table 167. HPT\_SetWindow Response**

| BIT               | B7 | B6 | B5 | B4 | B3 | B2 | B1 | B0 |
|-------------------|----|----|----|----|----|----|----|----|
| APResponse (0xB0) | 1  | 0  | 1  | 1  | 0  | 0  | 0  | 0  |

**Table 168. 0xB1 – HPT\_SetBackEMFCycle**

| MODE            | Write       |    |    |    |    |                 |    |    |
|-----------------|-------------|----|----|----|----|-----------------|----|----|
| BIT             | B7          | B6 | B5 | B4 | B3 | B2              | B1 | B0 |
| APCmdOut (0xB1) | 1           | 0  | 1  | 1  | 0  | 0               | 0  | 1  |
| APDataOut0      | BrkCyc[4:0] |    |    |    |    | EmfSkipCyc[2:0] |    |    |

**Table 169. HPT\_SetBackEMFCycle Response**

| BIT               | B7 | B6 | B5 | B4 | B3 | B2 | B1 | B0 |
|-------------------|----|----|----|----|----|----|----|----|
| APResponse (0xB1) | 1  | 0  | 1  | 1  | 0  | 0  | 0  | 1  |

**Table 170. 0xB2—HPT\_SetFullScale**

| MODE            | Write—      |    |    |    |    |    |    |    |
|-----------------|-------------|----|----|----|----|----|----|----|
| BIT             | B7          | B6 | B5 | B4 | B3 | B2 | B1 | B0 |
| APCmdOut (0xB2) | 1           | 0  | 1  | 1  | 0  | 0  | 1  | 0  |
| APDataOut0      | HptVfs[7:0] |    |    |    |    |    |    |    |

**Table 171. HPT\_SetFullScale Response**

| BIT               | B7 | B6 | B5 | B4 | B3 | B2 | B1 | B0 |
|-------------------|----|----|----|----|----|----|----|----|
| APResponse (0xB2) | 1  | 0  | 1  | 1  | 0  | 0  | 1  | 0  |

**Table 172. 0xB3—Hpt\_SetHptPattern**

| MODE            | Write           |    |    |    |    |    |    |    |
|-----------------|-----------------|----|----|----|----|----|----|----|
| BIT             | B7              | B6 | B5 | B4 | B3 | B2 | B1 | B0 |
| APCmdOut (0xB3) | 1               | 0  | 1  | 1  | 0  | 0  | 1  | 1  |
| APDataOut0      | ETRGdAmp[7:0]   |    |    |    |    |    |    |    |
| APDataOut1      | ETRGdDur[7:0]   |    |    |    |    |    |    |    |
| APDataOut2      | ETRGActAmp[7:0] |    |    |    |    |    |    |    |
| APDataOut3      | ETRGActDur[7:0] |    |    |    |    |    |    |    |
| APDataOut4      | ETRGBrkAmp[7:0] |    |    |    |    |    |    |    |
| APDataOut5      | ETRGBrkDur[7:0] |    |    |    |    |    |    |    |

**Table 173. Hpt\_SetHptPattern Response**

| BIT               | B7 | B6 | B5 | B4 | B3 | B2 | B1 | B0 |
|-------------------|----|----|----|----|----|----|----|----|
| APResponse (0xB3) | 1  | 0  | 1  | 1  | 0  | 0  | 1  | 1  |

**Table 174. 0xB4—Hpt\_SetGain**

| MODE            | Write |                |    |    |    |                |    |    |
|-----------------|-------|----------------|----|----|----|----------------|----|----|
| BIT             | B7    | B6             | B5 | B4 | B3 | B2             | B1 | B0 |
| APCmdOut (0xB4) | 1     | 0              | 1  | 1  | 0  | 1              | 0  | 0  |
| APDataOut0      | —     | NarLpGain[2:0] |    |    | —  | WidLpGain[2:0] |    |    |

**Table 175. Hpt\_SetGain Response**

| BIT               | B7 | B6 | B5 | B4 | B3 | B2 | B1 | B0 |
|-------------------|----|----|----|----|----|----|----|----|
| APResponse (0xB4) | 1  | 0  | 1  | 1  | 0  | 1  | 0  | 0  |

**Table 176. 0xB5—HPT\_SetLock**

| MODE            | Write |    |                |    |    |    |    |    |  |
|-----------------|-------|----|----------------|----|----|----|----|----|--|
| BIT             | B7    | B6 | B5             | B4 | B3 | B2 | B1 | B0 |  |
| APCmdOut (0xB5) | 1     | 0  | 1              | 1  | 0  | 1  | 0  | 1  |  |
| APDataOut0      | —     | —  | NarCntLck[5:0] |    |    |    |    |    |  |

**Table 177. Hpt\_SetLock Response**

| BIT               | B7 | B6 | B5 | B4 | B3 | B2 | B1 | B0 |
|-------------------|----|----|----|----|----|----|----|----|
| APResponse (0xB5) | 1  | 0  | 1  | 1  | 0  | 1  | 0  | 1  |

**Table 178. 0xB6—Hpt\_ReadResonanceFrequency**

| MODE            | Read |    |    |    |    |    |    |    |
|-----------------|------|----|----|----|----|----|----|----|
| BIT             | B7   | B6 | B5 | B4 | B3 | B2 | B1 | B0 |
| APCmdOut (0xB6) | 1    | 0  | 1  | 1  | 0  | 1  | 1  | 0  |

**Table 179. Hpt\_ReadResonanceFrequency Response**

| BIT               | B7              | B6 | B5 | B4 | B3               | B2 | B1 | B0 |
|-------------------|-----------------|----|----|----|------------------|----|----|----|
| APResponse (0xB6) | 1               | 0  | 1  | 1  | 0                | 1  | 1  | 0  |
| APDataIn0         | BEMFPeriod[7:0] |    |    |    |                  |    |    |    |
| APDataIn1         | —               | —  | —  | —  | BEMFPeriod[11:8] |    |    |    |

**Table 180. 0xB7—Hpt\_SetTimeout**

| MODE            | Write   |    |                |    |    |    |    |    |  |
|-----------------|---|----|----------------|----|----|----|----|----|--|
| BIT             | B7  | B6 | B5             | B4 | B3 | B2 | B1 | B0 |  |
| APCmdOut (0xB7) | 1   | 0  | 1              | 1  | 0  | 1  | 1  | 1  |  |
| APDataOut0      | —   | —  | HptDrvTmo[5:0] |    |    |    |    |    |  |
|                 | Haptic Driver Timeout<br>See Opcode 0xA8 for details on restarting the haptic driver. 1s Step resolution. If timeout is reached, the haptic driver is locked (HptLock = 1) and SystemError[7:0] = 0x04 is issued.<br>000000 = Disabled<br>000001 = 1s |    |                |    |    |    |    |    |  |

**Table 181. Hpt\_SetTimeout Response**

| BIT               | B7 | B6 | B5 | B4 | B3 | B2 | B1 | B0 |
|-------------------|----|----|----|----|----|----|----|----|
| APResponse (0xB7) | 1  | 0  | 1  | 1  | 0  | 1  | 1  | 1  |



**Table 182. 0xB8—Hpt\_GetTimeout**

| MODE            | Read |    |    |    |    |    |    |    |
|-----------------|------|----|----|----|----|----|----|----|
| BIT             | B7   | B6 | B5 | B4 | B3 | B2 | B1 | B0 |
| APCmdOut (0xB8) | 1    | 0  | 1  | 1  | 1  | 0  | 0  | 0  |

**Table 183. Hpt\_GetTimeout Response**

| BIT               | B7 | B6 | B5             | B4 | B3 | B2 | B1 | B0 |  |
|-------------------|----|----|----------------|----|----|----|----|----|--|
| APResponse (0xB8) | 1  | 0  | 1              | 1  | 1  | 0  | 0  | 0  |  |
| APDataIn0         | —  | —  | HptDrvTmo[5:0] |    |    |    |    |    |  |

**Table 184. 0xB9—Hpt\_SetBlankingWindow**

| MODE            | Write         |    |    |             |    |               |    |    |  |
|-----------------|---------------|----|----|-------------|----|---------------|----|----|--|
| BIT             | B7            | B6 | B5 | B4          | B3 | B2            | B1 | B0 |  |
| APCmdOut (0xB9) | 1             | 0  | 1  | 1           | 1  | 0             | 0  | 1  |  |
| APDataOut0      | BlankWdw[2:0] |    |    | BrkWdw[4:0] |    |               |    |    |  |
| APDataOut1      | —             | —  | —  | —           | —  | BlankWdw[5:3] |    |    |  |

**Table 185. Hpt\_SetBlankingWindow Response**

| BIT               | B7 | B6 | B5 | B4 | B3 | B2 | B1 | B0 |
|-------------------|----|----|----|----|----|----|----|----|
| APResponse (0xB9) | 1  | 0  | 1  | 1  | 1  | 0  | 0  | 1  |

**Table 186. 0xBA—Hpt\_SetZCC**

| MODE            | Write |    |    |    |    |    |           |             |
|-----------------|-------|----|----|----|----|----|-----------|-------------|
| BIT             | B7    | B6 | B5 | B4 | B3 | B2 | B1        | B0          |
| APCmdOut (0xBA) | 1     | 0  | 1  | 1  | 1  | 0  | 1         | 0           |
| APDataOut0      | —     | —  | —  | —  | —  | —  | ZccSlowEn | FiltrCntrEn |

**Table 187. Hpt\_SetZCC Response**

| BIT               | B7 | B6 | B5 | B4 | B3 | B2 | B1 | B0 |
|-------------------|----|----|----|----|----|----|----|----|
| APResponse (0xBA) | 1  | 0  | 1  | 1  | 1  | 0  | 1  | 0  |

## Power and Reset Commands

Table 188. 0x80—PowerOff\_Command

| MODE            | Write  |    |    |    |    |    |    |    |
|-----------------|--|----|----|----|----|----|----|----|
| BIT             | B7   | B6 | B5 | B4 | B3 | B2 | B1 | B0 |
| APCmdOut (0x80) | 1  | 0  | 0  | 0  | 0  | 0  | 0  | 0  |
| APDataOut0      | PwrOffCmd[7:0]   |    |    |    |    |    |    |    |
| PwrOffCmd [7:0] | Power-Off Command<br>Writing 0xB2 to this register will immediately place the part in the OFF state.<br>All other codes = Do nothing |    |    |    |    |    |    |    |

Table 189. PowerOff\_Command Response

| BIT               | B7   | B6 | B5 | B4 | B3 | B2 | B1 | B0             |
|-------------------|--|----|----|----|----|----|----|----------------|
| APResponse (0x80) | 1  | 0  | 0  | 0  | 0  | 0  | 0  | 0              |
| APDataIn0         | —  | —  | —  | —  | —  | —  | —  | PwrOffResponse |
| PwrOffResponse    | Power-Off Response<br>0 = Password good, preparing Off mode<br>1 = Password is wrong |    |    |    |    |    |    |                |

Table 190. 0x81 – SoftReset\_Command

| MODE                | Write   |    |    |    |    |    |    |    |
|---------------------|---|----|----|----|----|----|----|----|
| BIT                 | B7  | B6 | B5 | B4 | B3 | B2 | B1 | B0 |
| APCmdOut (0x81)     | 1   | 0  | 0  | 0  | 0  | 0  | 0  | 1  |
| APDataOut0          | SoftResetCmd[7:0]   |    |    |    |    |    |    |    |
| SoftReset Cmd [7:0] | Soft-Reset Command<br>Writing 0xB3 to this register will force a Soft-Reset, all registers will be reset to their default values and the RST line will be asserted.<br>All other codes = Do nothing |    |    |    |    |    |    |    |

Table 191. SoftReset\_Command Response

| BIT                | B7  | B6 | B5 | B4 | B3 | B2 | B1 | B0                |
|--------------------|---|----|----|----|----|----|----|-------------------|
| APResponse (0x81)  | 1   | 0  | 0  | 0  | 0  | 0  | 0  | 1                 |
| APDataIn0          | —   | —  | —  | —  | —  | —  | —  | SoftResetResponse |
| SoftReset Response | Soft-Reset Response<br>0 = Password good, preparing Soft-Reset<br>1 = Password is wrong |    |    |    |    |    |    |                   |

**Table 192. 0x82—Hard-Reset\_Command**

| MODE               | Write   |    |    |    |    |    |    |    |
|--------------------|---|----|----|----|----|----|----|----|
| BIT                | B7  | B6 | B5 | B4 | B3 | B2 | B1 | B0 |
| APCmdOut (0x82)    | 1   | 0  | 0  | 0  | 0  | 0  | 1  | 0  |
| APDataOut0         | HardResetCmd [7:0]  |    |    |    |    |    |    |    |
| HardReset Cmd[7:0] | Hard-Reset Command<br>Writing 0xB4 to this register will force the system to perform a Hard-Reset. All supplies will turn Off and system will perform a full power-on sequence.<br>All other codes = Do nothing |    |    |    |    |    |    |    |

**Table 193. Hard-Reset\_Command Response**

| BIT                | B7  | B6 | B5 | B4 | B3 | B2 | B1 | B0                 |
|--------------------|---|----|----|----|----|----|----|--------------------|
| APResponse (0x82)  | 1   | 0  | 0  | 0  | 0  | 0  | 1  | 0                  |
| APDataIn0          | —   | —  | —  | —  | —  | —  | —  | HardReset Response |
| HardReset Response | Hard-Reset Response<br>0 = Password good, preparing Hard-Reset<br>1 = Password is wrong |    |    |    |    |    |    |                    |

**Table 194. 0x83—StayOn\_Command**

| MODE            | Write  |    |    |    |    |    |    |        |
|-----------------|--|----|----|----|----|----|----|--------|
| BIT             | B7   | B6 | B5 | B4 | B3 | B2 | B1 | B0     |
| APCmdOut (0x83) | 1  | 0  | 0  | 0  | 0  | 0  | 1  | 1      |
| APDataOut0      | —  | —  | —  | —  | —  | —  | —  | StayOn |
| StayOn          | Stay On<br>This bit must be set within 5s of power-on to prevent the part from shutting down and returning to the power-off condition. This bit has no effect after being set.<br>0 = Shut down 5s after $\overline{RST}$ goes HIGH<br>1 = Stay on |    |    |    |    |    |    |        |

**Table 195. 0x83—StayOn\_Command Response**

| BIT               | B7 | B6 | B5 | B4 | B3 | B2 | B1 | B0 |
|-------------------|----|----|----|----|----|----|----|----|
| APResponse (0x83) | 1  | 0  | 0  | 0  | 0  | 0  | 1  | 1  |

**Table 196. 0x84—PowerOff\_Command\_Delay**

| MODE                | Write  |    |    |    |    |    |    |    |
|---------------------|--|----|----|----|----|----|----|----|
| BIT                 | B7   | B6 | B5 | B4 | B3 | B2 | B1 | B0 |
| APCmdOut (0x84)     | 1  | 0  | 0  | 0  | 0  | 1  | 0  | 0  |
| APDataOut0          | PwrOffDlyCmd[7:0]  |    |    |    |    |    |    |    |
| PwrOffDly Cmd [7:0] | Power-Off Command with Delay<br>Writing 0xB2 to this register will place the part in the Off state after a 30ms delay.<br>All other codes = Do nothing |    |    |    |    |    |    |    |

**Table 197. PowerOff\_Command\_Delay Response**

| BIT                | B7  | B6 | B5 | B4 | B3 | B2 | B1 | B0                 |
|--------------------|---|----|----|----|----|----|----|--------------------|
| APResponse (0x84)  | 1   | 0  | 0  | 0  | 0  | 1  | 0  | 0                  |
| APDataIn0          | —   | —  | —  | —  | —  | —  | —  | PwrOffDly Response |
| PwrOffDly Response | Power-Off with Delay Response<br>0 = Password good, preparing Off mode<br>1 = Password is wrong |    |    |    |    |    |    |                    |

## Fuel Gauge I<sup>2</sup>C Registers

### Register Summary

All registers must be written and read as 16-bit words; 8-bit writes cause no effect. Any bits marked X (don't care) or read only must be written with the rest of the register, but the value written is ignored by the IC. The values read from don't care bits are undefined. Calculate the register's value by multiplying the 16-bit word by the register's LSb value, as shown in [Table 198](#).

#### VCELL Register (0x02)

The MAX20353 measures VCELL between the V<sub>DD</sub> and GND pins. VCELL is the average of four ADC conversions. The value updates every 250ms in active mode and every 45s in hibernate mode.

#### SOC Register (0x04)

The ICs calculate SOC using the ModelGauge algorithm. This register automatically adapts to variation in battery size since ModelGauge naturally recognizes relative SOC.

The upper byte least-significant bit has units of 1%. The lower byte provides additional resolution.

The first update is available approximately 1s after POR of the IC. Subsequent updates occur at variable intervals depending on application conditions.

#### MODE Register (0x06)

The MODE register allows the system processor to send special commands to the IC (see [Figure 16](#)).

- **Quick-Start** generates a first estimate of OCV and SOC based on the immediate cell voltage. Use with caution; see the [Quick-Start](#) section.
- **EnSleep** enables sleep mode. See the [Sleep Mode](#) section.
- **HibStat** indicates when the IC is in hibernate mode (read only).

#### VERSION Register (0x08)

The value of this read-only register indicates the production version of the IC.

**Table 198. Register Summary**

| ADDRESS      | REGISTER NAME | 16-BIT LSb    | DESCRIPTION  | READ/WRITE | DEFAULT |
|--------------|---------------|---------------|--|------------|---------|
| 0x02         | VCELL         | 78.125μV/cell | ADC measurement of VCELL.  | R          | —       |
| 0x04         | SOC           | 1%/256        | Battery state of charge.   | R          | —       |
| 0x06         | MODE          | —             | Initiates quick-start, reports hibernate mode, and enables sleep mode.   | W          | 0x0000  |
| 0x08         | VERSION       | —             | IC production version.   | R          | 0x001_  |
| 0x0A         | HIBRT         | —             | Controls thresholds for entering and exiting hibernate mode.   | R/W        | 0x8030  |
| 0x0C         | CONFIG        | —             | Compensation to optimize performance, sleep mode, alert indicators, and configuration.                         | R/W        | 0x971C  |
| 0x14         | VALRT         | —             | Configures the VCELL range outside of which alerts are generated.  | R/W        | 0x00FF  |
| 0x16         | CRATE         | 0.208%/hr     | Approximate charge or discharge rate of the battery.   | R          | —       |
| 0x18         | VRESET/ID     | —             | Configures VCELL threshold below which the IC resets itself, ID is a one-time factory-programmable identifier. | R/W        | 0x96__  |
| 0x1A         | STATUS        | —             | Indicates overvoltage, undervoltage, SOC change, SOC low, and reset alerts.                                    | R/W        | 0x01__  |
| 0x40 to 0x7F | TABLE         | —             | Configures battery parameters.   | W          | —       |
| 0xFE         | CMD           | —             | Sends POR command.   | R/W        | 0xFFFF  |

**HIBRT Register (0x0A)**

To disable hibernate mode, set HIBRT = 0x0000. To always use hibernate mode, set HIBRT = 0xFFFF (see Figure 17).

- **ActThr** (active threshold): If at any ADC sample |OCV-CELL| is greater than ActThr, the IC exits hibernate mode. 1 LSb = 1.25mV.
- **HibThr** (hibernate threshold). If the absolute value of CRATE is less than HibThr for longer than 6min, the IC enters hibernate mode. 1 LSb = 0.208%/hr.

**CONFIG Register (0x0C)**

See Figure 18

- **RCOMP** is an 8-bit value that can be adjusted to optimize IC performance for different lithium chemistries or different operating temperatures. Contact Maxim for instructions for optimization. The POR value of RCOMP is 0x97.
- **SLEEP** forces the IC in or out of sleep mode if Mode.EnSleep is set. Writing 1 forces the IC to enter

sleep mode, and 0 forces the IC to exit. The POR value of SLEEP is 0.

- **ALSC** (SOC change alert) enables alerting when SOC changes by at least 1%. Each alert remains until STATUS.SC is cleared, after which the alert automatically clears until SOC again changes by 1%. Do not use this alert to accumulate changes in SOC.
- **ALRT** (alert status bit) is set by the IC when an alert occurs. When this bit is set, the  $\overline{\text{ALRT}}$  pin asserts low. Clear this bit to service and deassert the  $\overline{\text{ALRT}}$  pin. The power-up default value for ALRT is 0. The STATUS register specifies why the  $\overline{\text{ALRT}}$  pin was asserted.
- **ATHD** (empty alert threshold) sets the SOC threshold, where an interrupt is generated on the  $\overline{\text{ALRT}}$  pin and can be programmed from 1% up to 32%. The value is (32 - ATHD)% (e.g., 00000b → 32%, 00001b → 31%, 00010b → 30%, 11111b → 1%). The POR value of ATHD is 0x1C, or 4%. The alert only occurs on a falling edge past this threshold.

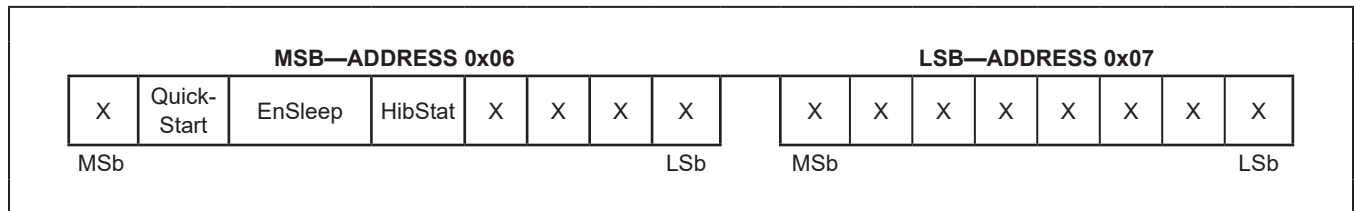

Figure 16. MODE Register Format

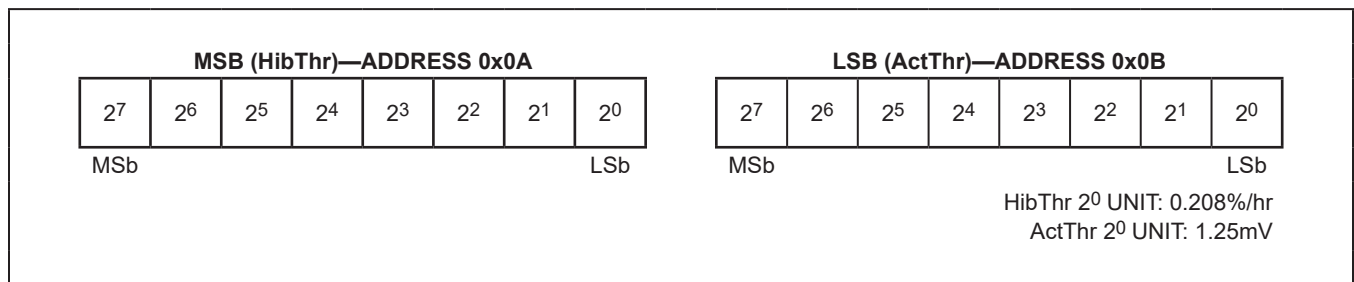

Figure 17. HIBRT Register Format

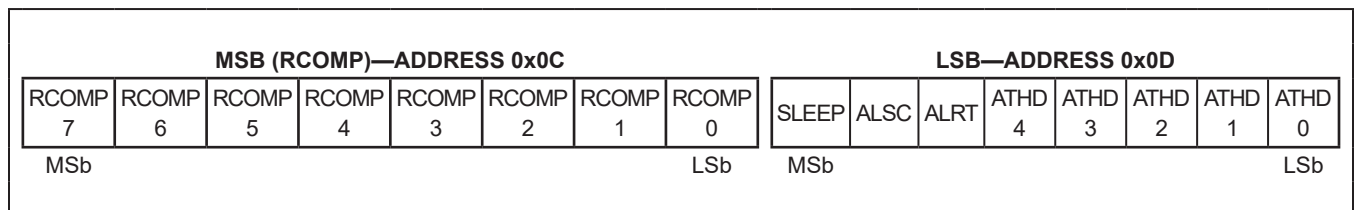

Figure 18. CONFIG Register Format

**VALRT Register (0x14)**

This register is divided into two thresholds: Voltage alert maximum (VALRT.MAX) and minimum (VALRT.MIN). Both registers have 1 LSb = 20mV. The IC alerts while VCELL > VALRT.MAX or VCELL < VALRT.MIN (see Figure 19).

**CRATE Register (0x16)**

The IC calculates an approximate value for the average SOC rate of change. 1 LSb = 0.208% per hour (not for conversion to ampere).

**VRESET/ID Register (0x18)**

See Figure 20.

- **ID** is an 8-bit read-only value that is one-time programmable at the factory, which can be used as an

identifier to distinguish multiple cell types in production. Writes to these bits are ignored.

- **VRESET[7:1]** adjusts a fast analog comparator and a slower digital ADC threshold to detect battery removal and reinsertion. For captive batteries, set to 2.5V. For removable batteries, set to at least 300mV below the application’s empty voltage, according to the desired reset threshold for your application. If the comparator is enabled, the IC resets 1ms after VCELL rises above the threshold. Otherwise, the IC resets 250ms after the VCELL register rises above the threshold.
- **Dis.** Set Dis = 1 to disable the analog comparator in hibernate mode to save approximately 0.5µA

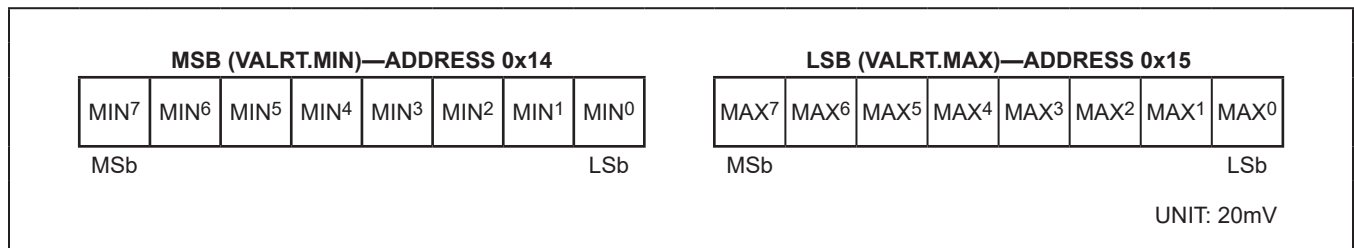

Figure 19. VALRT Register Format

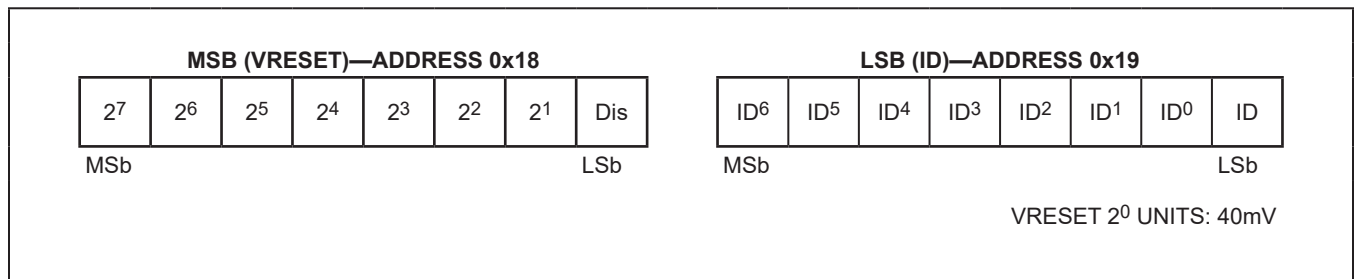

Figure 20. VRESET/ID Register Format

**STATUS Register (0x1A)**

An alert can indicate many different conditions. The STATUS register identifies which alert condition was met. Clear the corresponding bit after servicing the alert (see [Figure 21](#)).

**Reset Indicator:**

- **RI** (reset indicator) is set when the device powers up. Any time this bit is set, the IC is not configured, so the model should be loaded and the bit should be cleared.

**Alert Descriptors:**

These bits are set only when they cause an alert (e.g., if CONFIG.ALSC = 0, then SC is never set).

- **VH** (voltage high) is set when VCELL has been above ALRT.VALRTMAX.
- **VL** (voltage low) is set when VCELL has been below ALRT.VALRTMIN.
- **VR** (voltage reset) is set after the device has been reset regardless of EnVr.
- **HD** (SOC low) is set when SOC crosses the value in CONFIG.ATHD.
- **SC** (1% SOC change) is set when SOC changes by at least 1% if CONFIG.ALSC is set.

**Enable or Disable VRESET Alert:**

- **EnVr** (enable voltage reset alert) when set to 1 asserts the  $\overline{\text{ALRT}}$  pin when a voltage-reset event occurs under the conditions described by the VRESET/ ID register.

**TABLE Registers (0x40 to 0x7F)**

Contact Maxim for details on how to configure these registers. The default value is appropriate for some Li+ batteries.

To unlock the TABLE registers, write 0x57 to address 0x3F, and 0x4A to address 0x3E. While TABLE is unlocked, no ModelGauge registers are updated, so reload as soon as possible by writing 0x00 to address 0x3F, and 0x00 to address 0x3E.

**CMD Register (0xFE)**

Writing a value of 0x5400 to this register causes the device to completely reset as if power had been removed (see the *Power-On Reset (POR)* section). The reset occurs when the last bit has been clocked in. The IC does not respond with an I<sup>2</sup>C ACK after this command sequence.

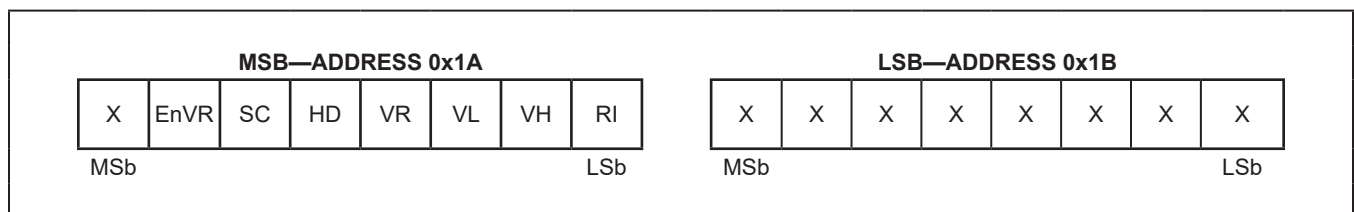

Figure 21. STATUS Register Format



**Table 199. Haptic Driver Recommended Default Values**

| REGISTER BITS       | BINARY SETTING | VALUE   |
|---------------------|----------------|---|
| EmfEn               | 1              | BEMF detection enabled                          |
| HptSel              | 1              | LRA   |
| AlcMod              | 1              | ALC enabled                                     |
| ZccHysEn            | 0              | ZCC Hysteresis Disabled                         |
| ZccSlowEn           | 0              | Normal ZCC operation                            |
| FiltrCntrEn         | 1              | Improved noise rejection                        |
| IniGssResDis        | 0              | Restore initial guess after braking             |
| AutoBrkPeakMeas     | 0              | Four points                                     |
| AutoBrkFiltrSatStop | 0              | Do not exit braking                             |
| AutoBrkMeasWdw      | 1000           | 40µs  |
| AutoBrkMeasTh       | 01             | 5.0mV   |
| AutoBrkDis          | 0              | Automatic braking enabled                       |
| AutoBrkMeasEnd      | 00             | 1 BEMF detection below threshold                |
| IniDly              | 00010          | 2 sine wave half periods skipped                |
| WidWdw              | 00101          | 5/32 <sup>nds</sup> of current sine wave period |
| WidLpGain           | 011            | 1/8   |
| NarWdw              | 0010           | 2/32 <sup>nds</sup> of current sine wave period |
| NarCntLck           | 000110         | 6 sine wave half periods                        |
| BrkLpGain           | 00             | Gain = 1  |
| NarLpGain           | 010            | 1/4   |
| BlankWdw            | 001000         | 40µs  |
| BrkWdw              | 01000          | 8/32 <sup>nds</sup> of current sine wave period |
| BrkCyc              | 11110          | 30 sine wave half periods                       |
| EmfSkipCyc          | 000            | 0 sine wave half periods                        |

**Table 200. Haptic Driver Recommended Default Values**

| OPCODE                   | REGISTER   | VALUE                 |
|--------------------------|------------|-----------------------|
| Hpt_Config_Write0 (0xA0) | APDataOut0 | 0x0E                  |
|                          | APDataOut1 | User Value            |
|                          | APDataOut2 | 0x1X (X = User Value) |
|                          | APDataOut3 | 0x02                  |
|                          | APDataOut4 | 0x05                  |
|                          | APDataOut5 | 0x02                  |
| Hpt_Config_Write1 (0xA2) | APDataOut0 | 0xF0                  |
|                          | APDataOut1 | 0x08                  |
|                          | APDataOut2 | 0x01                  |
|                          | APDataOut3 | User Value            |
|                          | APDataOut4 | User Value            |
|                          | APDataOut5 | User Value            |
| Hpt_Config_Write2 (0xA4) | APDataOut0 | User Value            |
|                          | APDataOut1 | User Value            |
|                          | APDataOut2 | User Value            |
|                          | APDataOut3 | User Value            |
|                          | APDataOut4 | 0x23                  |
|                          | APDataOut5 | 0x06                  |

**Table 201. Register Bit Default Values**

|              | DEFAULT VALUE         |                       |                      |
|--------------|-----------------------|-----------------------|----------------------|
|              | MAX20353A             | MAX20353B             | MAX20353C            |
| PFN2PUD_CFG* | Hi-Z                  | Hi-Z                  | PU/PD Connected      |
| PFN1PUD_CFG* | PU/PD Connected       | PU/PD Connected       | PU/PD Connected      |
| WriteProtect | Disabled              | Disabled              | Disabled             |
| ILimBlank    | Disabled              | 10ms                  | Disabled             |
| ILimCntl     | 500mA                 | 300mA                 | 500mA                |
| MtChgTmr     | 0min                  | 0min                  | 0min                 |
| FChgTmr      | 600min                | 150min                | 600min               |
| PChgTmr      | 30min                 | 60min                 | 30min                |
| TShdnTmo     | 10s                   | 5s                    | 5s                   |
| ChgAutoRe    | Auto-Restart          | Auto-Restart          | Auto-Restart         |
| VPChg        | 3.15V                 | 3V                    | 3.15V                |
| IPChg        | 10% I <sub>FCHG</sub> | 10% I <sub>FCHG</sub> | 5% I <sub>FCHG</sub> |
| ChgDone      | 10% I <sub>FCHG</sub> | 5% I <sub>FCHG</sub>  | 5% I <sub>FCHG</sub> |
| ChgEn        | Disabled              | Enabled               | Disabled             |
| ChgAutoStp   | Enabled               | Enabled               | Enabled              |
| BatReChg     | 200mV                 | 170mV                 | 220mV                |

**Table 201. Register Bit Default Values (continued)**

|                | DEFAULT VALUE    |                  |                    |
|----------------|------------------|------------------|--------------------|
|                | MAX20353A        | MAX20353B        | MAX20353C          |
| BatReg         | 4.35V            | 4.35V            | 4.35V              |
| ColdLim        | 1397.65mV        | 1327.06mV        | 1037.65mV          |
| HotLim         | 529.41mV         | 416.47mV         | 240mV              |
| BstISet        | 425mA            | 275mA            | 125mA              |
| BstIAdptEn     | Enabled          | Enabled          | Enabled            |
| BstFastStrt    | 50ms             | 100ms            | 100ms              |
| BstFetScale    | Disabled         | Disabled         | Disabled           |
| BstVSet        | 20V              | 14.5V            | 5V                 |
| Buck1FetScale  | Disabled         | Disabled         | Disabled           |
| Buck2FetScale  | Disabled         | Enabled          | Disabled           |
| BstSeq         | BstEn After 100% | BstEn After 100% | BoostEn After 100% |
| BstEn          | Disabled         | Disabled         | MPC Reg Defined    |
| Buck1VSet      | 1.8V             | 1.825V           | 1.825V             |
| Buck1IZCSet    | 30mA             | 30mA             | 30mA               |
| Buck2VSet      | 0.9V             | 2.00V            | 3.20V              |
| Buck2IZCSet    | 10mA             | 30mA             | 10mA               |
| Buck2ISet      | 150mA            | 75mA             | 150mA              |
| Buck1ISet      | 150mA            | 150mA            | 150mA              |
| BootDly**      | 120ms            | 80ms             | 120ms              |
| Buck2SftStrt   | 50ms Soft-Start  | 25ms Soft-Start  | 50ms Soft-Start    |
| Buck1SftStrt   | 50ms Soft-Start  | 25ms Soft-Start  | 50ms Soft-Start    |
| Buck2En        | Disabled         | Enabled          | Disabled           |
| Buck1En        | Enabled          | Enabled          | Enabled            |
| LDO1Md         | LDO              | Load Switch      | Load Switch        |
| LDO1En         | Disabled         | Disabled         | Direct Reg Control |
| LDO2Md         | LDO              | LDO              | LDO                |
| LDO2En         | Disabled         | Disabled         | Direct Reg Control |
| PassDiscEna*** | Enabled          | Enabled          | Enabled            |
| LDO2VSet       | 3.2V             | 3.6V             | 3.2V               |
| StayOn         | Enabled          | Enabled          | Enabled            |
| SFOUTVSet      | 3.3V             | 5.0V             | 3.3V               |
| LDO1VSet       | 1.2V             | 1.825V           | 1.8V               |
| SysMinVlt      | 3.6V             | 3.6V             | 3.6V               |
| SFOUTEn        | CHGIN            | Disabled         | Disabled           |
| CPVSet         | 6.6V             | 5.0V             | 5.0V               |
| CPEn           | Disabled         | Disabled         | Disabled           |
| CPSeq          | CPEn After 100%  | Disabled         | CPEn After 100%    |

**Table 201. Register Bit Default Values (continued)**

|                         | DEFAULT VALUE      |                    |                    |
|-------------------------|--------------------|--------------------|--------------------|
|                         | MAX20353A          | MAX20353B          | MAX20353C          |
| PwrRstCfg               | 0b0110             | 0b0111             | 0b1000             |
| Buck2Seq                | Buck2En After 100% | Buck2En After 100% | Buck2En After 100% |
| Buck1Seq                | Buck1En After 100% | 0%                 | 0%                 |
| BBstEn                  | Disabled           | Disabled           | Disabled           |
| LDO2Seq                 | LDO2En After 100%  | LDO2En After 100%  | LDO2En After 100%  |
| LDO1Seq                 | LDO1En After 100%  | LDO1En After 100%  | LDO1En After 100%  |
| ThmEn                   | Disabled           | Enabled            | Enabled            |
| BBstVset                | 5V                 | 3.8V               | 4.5V               |
| BBstIset                | 100mA              | 100mA              | 50mA               |
| BatOcThr                | 1000mA             | 400mA              | 1000mA             |
| BBstRipRed              | Lower Ripple       | Lower Ripple       | Lower Ripple       |
| BBstInd                 | 4.7μH              | 4.7μH              | 4.7μH              |
| BBstSeq                 | BBstEn After 100%  | BBstEn After 100%  | BBstEn After 100%  |
| EmfEn                   | Disabled           | Enabled            | Enabled            |
| HptSel                  | ERM                | ERM                | LRA                |
| AlcMod                  | Enabled            | Disabled           | Enabled            |
| HptSysUVLO              | 3V                 | 3V                 | 3.21V              |
| HptDrvTmo               | 10s                | Disabled           | 10s                |
| ILimMax****             | 1000mA             | 450mA              | 1000mA             |
| T <sub>CHGIN_SHDN</sub> | 100°C              | 100°C              | 100°C              |

\*See Table 202

\*\*Sets  $t_{RST}$  time. See Figure 3

\*\*\*If enabled, passive discharge is enabled for all rails in off mode.

\*\*\*\*Current limit during  $t_{LimBlank}$ **Table 202. PFN Connections and Logic Configurations**

| FUNCTION               | DEVICE CONFIGURATION          |                               |                               |
|------------------------|-------------------------------|-------------------------------|-------------------------------|
|                        | MAX20353A                     | MAX20353B                     | MAX20353C                     |
| PFN1                   | Pullup                        | Pullup                        | Pullup                        |
| PFN2                   | Hi-Z                          | Hi-Z                          | Pullup                        |
| ON STATE LOGIC LEVELS* | $V_{PFN\_IH}$ , $V_{PFN\_IL}$ | $V_{PFN\_IH}$ , $V_{PFN\_IL}$ | $V_{PFN\_IH}$ , $V_{PFN\_IL}$ |

\*Values in this row reference EC table parameters. In OFF mode,  $V_{PFN\_IH}$  and  $V_{PFN\_IL}$  logic levels always apply.

**Table 203. I<sup>2</sup>C Direct Register Default Values**

| REGISTER | NAME           | DEFAULT VALUE |           |           |
|----------|----------------|---------------|-----------|-----------|
|          |                | MAX20353A     | MAX20353B | MAX20353C |
| 0x00     | HardwareID     | 0x03          | 0x03      | 0x03      |
| 0x01     | FirmwareID     | 0x02          | 0x02      | 0x02      |
| 0x0B     | SystemError    | 0x00          | 0x00      | 0x00      |
| 0x0C     | IntMask0       | 0x00          | 0x00      | 0x00      |
| 0x0D     | IntMask1       | 0x00          | 0x00      | 0x00      |
| 0x0E     | IntMask2       | 0x40          | 0x40      | 0x40      |
| 0x0F     | APDataOut0     | 0x00          | 0x00      | 0x00      |
| 0x10     | APDataOut1     | 0x00          | 0x00      | 0x00      |
| 0x11     | APDataOut2     | 0x00          | 0x00      | 0x00      |
| 0x12     | APDataOut3     | 0x00          | 0x00      | 0x00      |
| 0x13     | APDataOut4     | 0x00          | 0x00      | 0x00      |
| 0x14     | APDataOut5     | 0x00          | 0x00      | 0x00      |
| 0x15     | APDataOut6     | 0x00          | 0x00      | 0x00      |
| 0x17     | APCmdOut       | 0x00          | 0x00      | 0x00      |
| 0x18     | APResponse     | 0x00          | 0x00      | 0x00      |
| 0x19     | APDataIn0      | 0x00          | 0x00      | 0x00      |
| 0x1A     | APDataIn1      | 0x00          | 0x00      | 0x00      |
| 0x1B     | APDataIn2      | 0x00          | 0x00      | 0x00      |
| 0x1C     | APDataIn3      | 0x00          | 0x00      | 0x00      |
| 0x1D     | APDataIn4      | 0x00          | 0x00      | 0x00      |
| 0x1E     | APDataIn5      | 0x00          | 0x00      | 0x00      |
| 0x20     | LDODirect      | 0x00          | 0x00      | 0x00      |
| 0x21     | MPCDirectWrite | 0x00          | 0x00      | 0x00      |
| 0x28     | HptRAMAddr     | 0x00          | 0x00      | 0x00      |
| 0x29     | HptRAMDataH    | 0x4A          | 0x4A      | 0x4A      |
| 0x2A     | HptRAMDataM    | 0x74          | 0x74      | 0x74      |
| 0x2B     | HptRAMDataL    | 0x63          | 0x63      | 0x63      |
| 0x2C     | LEDStepDirect  | 0x00          | 0x00      | 0x00      |
| 0x2D     | LED0Direct     | 0x00          | 0x00      | 0x00      |
| 0x2E     | LED1Direct     | 0x00          | 0x00      | 0x00      |
| 0x2F     | LED2Direct     | 0x00          | 0x00      | 0x00      |
| 0x30     | HptDirect0     | 0x04          | 0x04      | 0x04      |
| 0x31     | HptDirect1     | 0x00          | 0x00      | 0x00      |
| 0x32     | HptRTI2Camp    | 0x00          | 0x00      | 0x00      |
| 0x33     | HptPatRAMAddr  | 0x00          | 0x00      | 0x00      |

**Table 204. Read Opcode Default Values**

| OPCODE                                     | REGISTER  | DEFAULT VALUE |           |           |
|--|-----------|---------------|-----------|-----------|
|  |           | MAX20353A     | MAX20353B | MAX20353C |
| GPIO_Config_Read<br>(0x02)                 | APDataIn0 | 0x00          | 0x00      | 0x00      |
|  | APDataIn1 | 0x00          | 0x00      | 0x00      |
|  | APDataIn2 | 0x00          | 0x00      | 0x00      |
|  | APDataIn3 | 0x00          | 0x00      | 0x00      |
|  | APDataIn4 | 0x00          | 0x00      | 0x00      |
| GPIO_Control_Read<br>(0x04)                | APDataIn0 | 0x00          | 0x00      | 0x00      |
| MPC_Config_Read<br>(0x07)                  | APDataIn0 | 0x00          | 0x00      | 0x00      |
|  | APDataIn1 | 0x00          | 0x00      | 0x00      |
|  | APDataIn2 | 0x00          | 0x00      | 0x00      |
|  | APDataIn3 | 0x00          | 0x00      | 0x00      |
|  | APDataIn4 | 0x00          | 0x00      | 0x00      |
| InputCurrent_Config_Read<br>(0x11)         | APDataIn0 | 0x06          | 0x1C      | 0x06      |
| ThermalShutdown_Config_Read<br>(0x12)      | APDataIn0 | 0x03          | 0x03      | 0x03      |
| Charger_Config_Read<br>(0x15)              | APDataIn0 | 0x0C          | 0x05      | 0x0C      |
|  | APDataIn1 | 0x75          | 0x64      | 0x70      |
|  | APDataIn2 | 0xF6          | 0xE6      | 0xF6      |
|  | APDataIn3 | 0x00          | 0x00      | 0x00      |
| ChargerThermalLimits_Config_Read<br>(0x17) | APDataIn0 | 0xC6          | 0xBC      | 0x93      |
|  | APDataIn1 | 0xC6          | 0xBC      | 0x93      |
|  | APDataIn2 | 0x4B          | 0x3B      | 0x22      |
|  | APDataIn3 | 0x4B          | 0x3B      | 0x22      |
| ChargerThermalReg_ConfigRead<br>(0x19)     | APDataIn0 | 0x00          | 0x00      | 0x00      |
|  | APDataIn1 | 0x00          | 0x00      | 0x00      |
|  | APDataIn2 | 0x1F          | 0x1F      | 0x1F      |
|  | APDataIn3 | 0x00          | 0x00      | 0x00      |
|  | APDataIn4 | 0x00          | 0x00      | 0x00      |
| Charger_Control_Read<br>(0x1B)             | APDataIn0 | 0x00          | 0x03      | 0x02      |
| Charger_JEITAHyst_ControlRead<br>(0x1D)    | APDataIn0 | 0x86          | 0x86      | 0x86      |
| Bst_Config_Read<br>(0x31)                  | APDataIn0 | 0x00          | 0x00      | 0x02      |
|  | APDataIn1 | 0x06          | 0x04      | 0x04      |
|  | APDataIn2 | 0x0D          | 0x07      | 0x01      |
|  | APDataIn3 | 0x3C          | 0x26      | 0x00      |
|  | APDataIn4 | 0x00          | 0x07      | 0x07      |

**Table 204. Read Opcode Default Values (continued)**

| OPCODE                           | REGISTER  | DEFAULT VALUE |           |           |
|----------------------------------|-----------|---------------|-----------|-----------|
|                                  |           | MAX20353A     | MAX20353B | MAX20353C |
| Buck1_Config_Read<br>(0x36)      | APDataIn0 | 0x00          | 0x20      | 0x00      |
|                                  | APDataIn1 | 0xA8          | 0xAD      | 0xAD      |
|                                  | APDataIn2 | 0x26          | 0x26      | 0x26      |
|                                  | APDataIn3 | 0x01          | 0x01      | 0x01      |
|                                  | APDataIn4 | 0x07          | 0x02      | 0x07      |
| Buck2_Config_Read<br>(0x3B)      | APDataIn0 | 0x00          | 0x22      | 0x00      |
|                                  | APDataIn1 | 0x82          | 0x9A      | 0xB2      |
|                                  | APDataIn2 | 0x06          | 0x23      | 0x06      |
|                                  | APDataIn3 | 0x00          | 0x01      | 0x00      |
|                                  | APDataIn4 | 0x07          | 0x07      | 0x07      |
| LDO1_Config_Read<br>(0x41)       | APDataIn0 | 0x00          | 0x00      | 0x00      |
|                                  | APDataIn1 | 0x1C          | 0x35      | 0x34      |
|                                  | APDataIn2 | 0x07          | 0x07      | 0x07      |
| LDO2_Config_Read<br>(0x43)       | APDataIn0 | 0x00          | 0x00      | 0x00      |
|                                  | APDataIn1 | 0x17          | 0x1B      | 0x17      |
|                                  | APDataIn2 | 0x07          | 0x07      | 0x07      |
| ChargePump_Config_Read<br>(0x47) | APDataIn0 | 0x00          | 0x00      | 0x00      |
|                                  | APDataIn1 | 0x00          | 0x01      | 0x01      |
|                                  | APDataIn2 | 0x07          | 0x00      | 0x07      |
| SFOUT_Config_Read<br>(0x49)      | APDataIn0 | 0x05          | 0x00      | 0x04      |
| MONMux_Config_Read<br>(0x51)     | APDataIn0 | 0x00          | 0x00      | 0x00      |
| BBst_Config_Read<br>(0x71)       | APDataIn0 | 0x00          | 0x00      | 0x00      |
|                                  | APDataIn1 | 0x02          | 0x02      | 0x01      |
|                                  | APDataIn2 | 0x19          | 0x0D      | 0x14      |
|                                  | APDataIn3 | 0x50          | 0x50      | 0x50      |
|                                  | APDataIn4 | 0x07          | 0x07      | 0x07      |
| Hpt_Config_Read0<br>(0xA1)       | APDataIn0 | 0x02          | 0x08      | 0x0E      |
|                                  | APDataIn1 | 0xD0          | 0xD0      | 0xD0      |
|                                  | APDataIn2 | 0x97          | 0x17      | 0x17      |
|                                  | APDataIn3 | 0x00          | 0x03      | 0x03      |
|                                  | APDataIn4 | 0x05          | 0x05      | 0x05      |
|                                  | APDataIn5 | 0x01          | 0x01      | 0x01      |

**Table 204. Read Opcode Default Values (continued)**

| OPCODE                                  | REGISTER  | DEFAULT VALUE |           |           |
|---|-----------|---------------|-----------|-----------|
|   |           | MAX20353A     | MAX20353B | MAX20353C |
| Hpt_Config_Read1<br>(0xA3)              | APDataIn0 | 0x01          | 0x01      | 0x01      |
|   | APDataIn1 | 0x00          | 0x00      | 0x00      |
|   | APDataIn2 | 0x02          | 0x02      | 0x02      |
|   | APDataIn3 | 0x8B          | 0x8B      | 0x8B      |
|   | APDataIn4 | 0x7F          | 0x7F      | 0x7F      |
|   | APDataIn5 | 0x04          | 0x04      | 0x04      |
| Hpt_Config_Read2<br>(0xA5)              | APDataIn0 | 0xCC          | 0x4C      | 0x4C      |
|   | APDataIn1 | 0x32          | 0x32      | 0x32      |
|   | APDataIn2 | 0xFF          | 0xFF      | 0xFF      |
|   | APDataIn3 | 0x04          | 0x04      | 0x04      |
|   | APDataIn4 | 0x24          | 0x24      | 0x24      |
|   | APDataIn5 | 0x06          | 0x06      | 0x06      |
| Hpt_SYS_Threshold_Config_Read<br>(0xA7) | APDataIn0 | 0x8B          | 0x8B      | 0x95      |
| Hpt_Lock_Config_Read<br>(0xA9)          | APDataIn0 | 0x00          | 0x00      | 0x00      |
| Hpt_EMF_Threshold_Config_Read<br>(0xAB) | APDataIn0 | 0x19          | 0x19      | 0x19      |

## Ordering Information

| PART                 | TEMP RANGE     | PIN-PACKAGE |
|----------------------|----------------|-------------|
| <b>MAX20353AEWN+</b> | -40°C to +85°C | 56 WLP      |
| MAX20353AEWN+T       | -40°C to +85°C | 56 WLP      |
| <b>MAX20353BEWN+</b> | -40°C to +85°C | 56 WLP      |
| MAX20353BEWN+T       | -40°C to +85°C | 56 WLP      |
| <b>MAX20353CEWN+</b> | -40°C to +85°C | 56 WLP      |
| MAX20353CEWN+T       | -40°C to +85°C | 56 WLP      |

+Denotes a lead (Pb)-free package/RoHS-compliant package.  
T = Tape and reel

## Chip Information

PROCESS: BiCMOS