

MAXIM

+5V, 1 μ A, Single RS-232 Transceiver with AutoShutdown

MAX221

General Description

The MAX221 is a +5V-powered, single transmit/receive RS-232 and V.28 communications interface with automatic shutdown/wake-up features and high data rate capabilities.

The MAX221 achieves a low 1 μ A supply current with Maxim's revolutionary AutoShutdown™ feature. AutoShutdown saves power without changes to the existing BIOS or operating system by entering low-power shutdown mode when the RS-232 cable is disconnected, or when the transmitter of the connected peripheral is off. The MAX221 wakes up and drives the $\overline{\text{INVALID}}$ pin high when an active RS-232 cable is connected, signaling the host that a peripheral is connected to the communications port.

The MAX221 is available in a 16-pin SSOP package as well as a 16-pin TSSOP that uses 50% less board space than a 16-pin SO. For an equivalent RS-232 transceiver with enhanced $\pm 15\text{kV}$ ESD protection, refer to the MAX221E data sheet.

Applications

Maintenance/Diagnostic Ports
Industrial Systems
Telecommunications
Set-Top Boxes

Pin Configuration

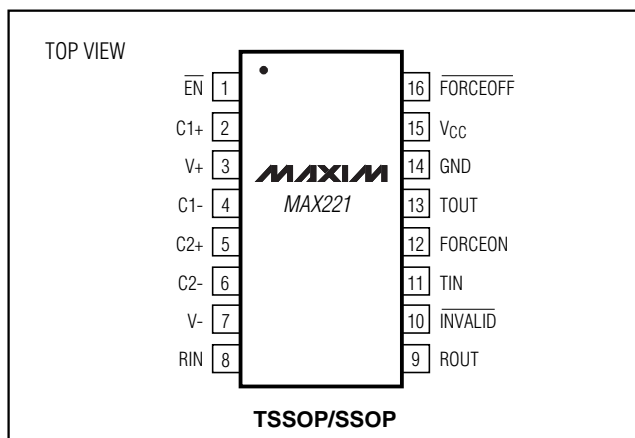

Features

- ◆ Single RS-232 Transceiver in a Small 16-Pin TSSOP Package
- ◆ 1 μ A Supply Current
- ◆ AutoShutdown Saves Power Without Changes to BIOS
- ◆ Guaranteed 250kbps Data Rate

Ordering Information

PART	TEMP. RANGE	PIN-PACKAGE
MAX221CUE	0°C to +70°C	16 TSSOP
MAX221CAE	0°C to +70°C	16 SSOP
MAX221EUE	-40°C to +85°C	16 TSSOP
MAX221EAE	-40°C to +85°C	16 SSOP

Typical Operating Circuit

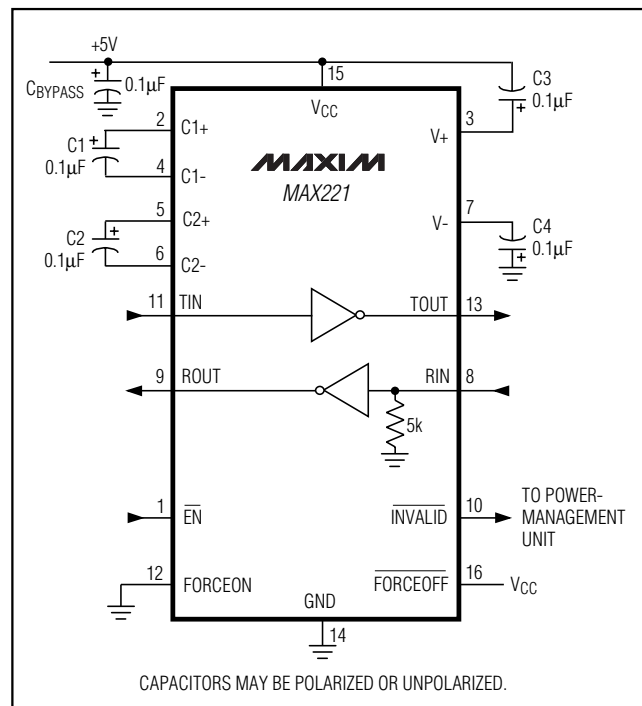

AutoShutdown is a trademark of Maxim Integrated Products.

MAXIM

Maxim Integrated Products 1

For free samples & the latest literature: <http://www.maxim-ic.com>, or phone 1-800-998-8800.
For small orders, phone 1-800-835-8769.

+5V, 1 μ A, Single RS-232 Transceiver with AutoShutdown

ABSOLUTE MAXIMUM RATINGS

V _{CC}	-0.3V to +6V	Short-Circuit Duration, T _{OUT}	Continuous
V ₊	(V _{CC} - 0.3V) to +14V	Continuous Power Dissipation (T _A = +70°C)	
V ₋	-14V to +0.3V	TSSOP (derated 6.7mW/°C above +70°C)	533mW
Input Voltages		SSOP (derated 7.1mW/°C above +70°C)	571mW
T _{IN}	-0.3V to (V ₊ + 0.3V)	Operating Temperature Range	
R _{IN}	±30V	MAX221C_	0°C to +70°C
FORCEON, FORCEOFF, EN	-0.3V to (V _{CC} + 0.3V)	MAX221E_	-40°C to +85°C
Output Voltages		Maximum Junction Temperature	+150°C
T _{OUT}	(V ₋ - 0.3V) to (V ₊ + 0.3V)	Storage Temperature Range	-65°C to +150°C
R _{OUT} , $\overline{\text{INVALID}}$	-0.3V to (V _{CC} + 0.3V)	Lead Temperature (soldering, 10sec)	+300°C

Stresses beyond those listed under "Absolute Maximum Ratings" may cause permanent damage to the device. These are stress ratings only, and functional operation of the device at these or any other conditions beyond those indicated in the operational sections of the specifications is not implied. Exposure to absolute maximum rating conditions for extended periods may affect device reliability.

ELECTRICAL CHARACTERISTICS

(V_{CC} = +5V \pm 10%, C1–C4 = 0.1 μ F, T_A = T_{MIN} to T_{MAX}, unless otherwise noted. Typical values are at T_A = +25°C.)

PARAMETER	SYMBOL	CONDITIONS	MIN	TYP	MAX	UNITS
DC CHARACTERISTICS						
V _{CC} Supply Current	I _{CC}	No load, T _A = +25°C		5	10	mA
Shutdown Supply Current	I _{SHDN}	T _A = +25°C, Figure 1		1	10	μ A
AutoShutdown Supply Current	I _{AS}			1	10	μ A
LOGIC INPUTS						
Input Leakage Current	I _{IN}	T _{IN} = 0 to V _{CC}			±1	μ A
Input Threshold Low	V _{IL}	T _{IN} ; EN, FORCEOFF, FORCEON			0.8	V
Input Threshold High	V _{IH}	T _{IN} , EN, FORCEOFF	2.4			V
Output Voltage Low	V _{OL}	R _{OUT} ; I _{SINK} = 3.2mA			0.4	V
Output Voltage High	V _{OH}	R _{OUT} ; I _{SOURCE} = 1.0mA	3.5			V
Output Leakage Current		$\overline{\text{EN}}$ = V _{CC} , 0 \leq R _{OUT} \leq V _{CC}		±0.05	±10	μ A
AUTOSHUTDOWN						
Receiver Input Threshold, Transmitter Enabled		Figure 3	Positive threshold		2.7	V
			Negative threshold		-2.7	
Receiver Input Threshold, Transmitter Disabled		I _{CC} = 1 μ A, Figure 3	-0.3		0.3	V
$\overline{\text{INVALID}}$ Output Voltage Low		I _{SINK} = 1.6mA			0.4	V
$\overline{\text{INVALID}}$ Output Voltage High		I _{SOURCE} = 1.0mA	V _{CC} - 0.6			V
Receiver Threshold to Transmitter Enabled	t _{WU}	Figure 3		250		μ s
Receiver Positive or Negative Threshold to $\overline{\text{INVALID}}$ High	t _{INVH}	Figure 3		1		μ s
Receiver Positive or Negative Threshold to $\overline{\text{INVALID}}$ Low	t _{INVL}	Figure 3		30		μ s

+5V, 1μA, Single RS-232 Transceiver with AutoShutdown

MAX221

ELECTRICAL CHARACTERISTICS (continued)

(V_{CC} = +5V ±10%, C1–C4 = 0.1μF, T_A = T_{MIN} to T_{MAX}, unless otherwise noted. Typical values are at T_A = +25°C.)

PARAMETER	SYMBOL	CONDITIONS	MIN	TYP	MAX	UNITS
RECEIVER INPUT						
Input Voltage Range			-25		25	V
Input Threshold Low		T _A = +25°C, V _{CC} = 5V	0.8	1.2		V
Input Threshold High		T _A = +25°C, V _{CC} = 5V		1.7	2.4	V
Input Hysteresis		V _{CC} = 5V, no hysteresis in shutdown		0.5		V
Input Resistance		T _A = +25°C, V _{CC} = 5V	3	5	7	kΩ
TRANSMITTER OUTPUT						
Output Voltage Swing		Driver loaded with 3kΩ to ground	±5	±9		V
Output Resistance		V _{CC} = V ₊ = V ₋ = 0, V _{OUT} = ±2V	300			Ω
Output Short-Circuit Current				±10	±60	mA

TIMING CHARACTERISTICS

(V_{CC} = +5V ±10%, C1–C4 = 0.1μF, T_A = T_{MIN} to T_{MAX}, unless otherwise noted. Typical values are at T_A = +25°C.)

PARAMETER	SYMBOL	CONDITIONS	MIN	TYP	MAX	UNITS
Maximum Data Rate		R _L = 3kΩ to 7kΩ, C _L = 50pF to 1000pF, V _{CC} = 4.5V	250			kbps
Receiver Propagation Delay	t _{PHL} , t _{PLH}	C _L = 150pF		0.15		μs
Receiver Output Enable Time		Normal operation		300		ns
Receiver Output Disable Time		Normal operation		200		ns
Transmitter Skew	t _{PHL} - t _{PLH}	(Note 1)		200		ns
Receiver Skew	t _{PHL} - t _{PLH}			50		ns
Transition-Region Slew Rate		T _A = +25°C, V _{CC} = 5V, R _L = 3kΩ to 7kΩ, C _L = 500pF to 1000pF, measured from -3V to +3V or +3V to -3V	3	6	30	V/μs

Note 1: Transmitter skew is measured at the transmitter zero crosspoints.

+5V, 1μA, Single RS-232 Transceiver with AutoShutdown

Typical Operating Characteristics

(V_{CC} = +5V, 250kbps data rate, 0.1μF capacitors, transmitter loaded with 3kΩ and C_L, T_A = +25°C, unless otherwise noted.)

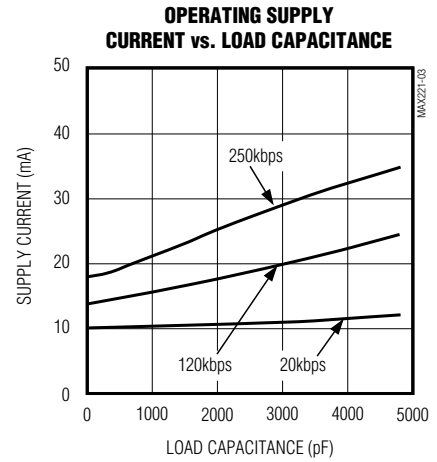
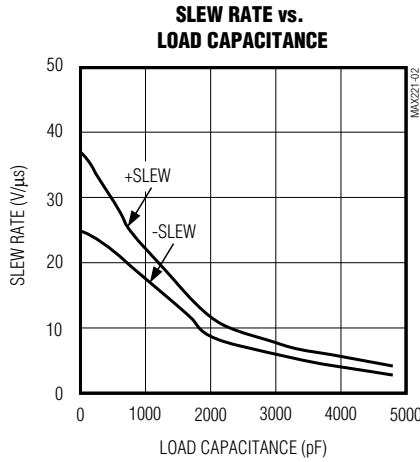
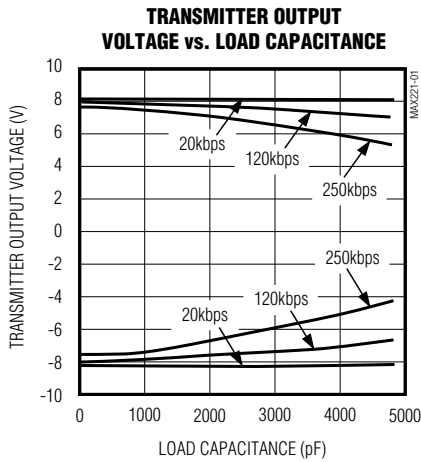

Pin Description

PIN	NAME	FUNCTION
1	$\overline{\text{EN}}$	Receiver Enable Control. Drive low for normal operation. Drive high to force the receiver output (ROUT) into a high-impedance state.
2	C1+	Positive Terminal of the Voltage Doubler Charge-Pump Capacitor
3	V+	Positive Voltage Generated by the Charge Pump
4	C1-	Negative Terminal of the Voltage Doubler Charge-Pump Capacitor
5	C2+	Positive Terminal of the Inverting Charge-Pump Capacitor
6	C2-	Negative Terminal of the Inverting Charge-Pump Capacitor
7	V-	Negative Voltage Generated by the Charge Pump
8	RIN	RS-232 Receiver Input
9	ROUT	TTL/CMOS Receiver Output
10	$\overline{\text{INVALID}}$	Output of the Invalid Signal Detector. $\overline{\text{INVALID}}$ is pulled low if no valid RS-232 level is present on the receiver input.
11	TIN	TTL/CMOS Transmitter Input
12	FORCEON	Drive high to override automatic circuitry, keeping transmitter and charge pump on. $\overline{\text{FORCEOFF}}$ must be high (Table 1).
13	TOUT	RS-232 Transmitter Output
14	GND	Ground
15	V _{CC}	+4.5V to +5.5V Supply Voltage
16	$\overline{\text{FORCEOFF}}$	Force-Off Input, active low. Drive low to shut down transmitter, receiver, and on-board charge pump. This overrides all automatic circuitry and FORCEON (Table 1).

+5V, 1 μ A, Single RS-232 Transceiver with AutoShutdown

MAX221

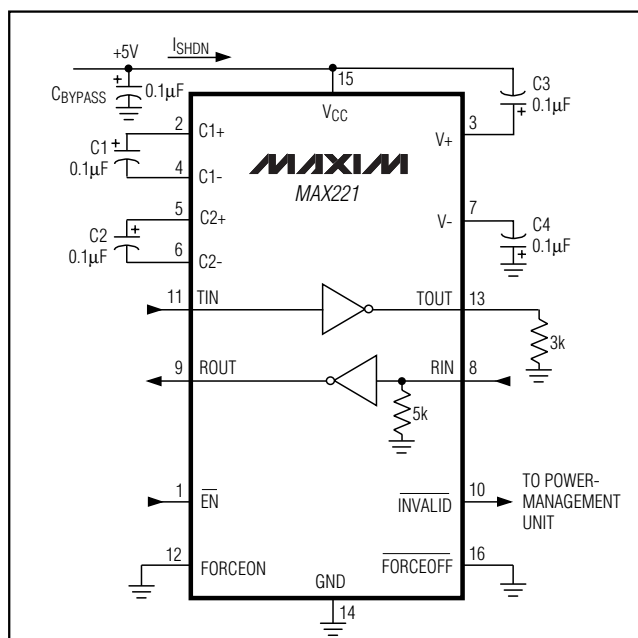

Figure 1. Shutdown Current Test Circuit

Detailed Description

Dual Charge-Pump Voltage Converter

The MAX221's internal power supply consists of a dual charge pump that provides a positive output voltage (doubling charge pump) and a negative voltage (inverting charge pump) from a single +5V supply. The charge pumps operate in continuous mode. Each charge pump requires a flying capacitor (C1, C2) and a reservoir capacitor (C3, C4) to generate the V+ and V- supplies.

RS-232 Transmitter

The transmitter is an inverting level translator that converts CMOS-logic levels to 5.0V EIA/TIA-232 levels. It guarantees a 250kbps data rate with worst-case loads of 3k Ω in parallel with 1000pF.

When $\overline{\text{FORCEOFF}}$ is driven to ground, or when the AutoShutdown circuitry senses invalid voltage levels on the receiver input, the transmitter is disabled and the output is forced into a high-impedance state. The transmitter input does not have a pull-up resistor.

RS-232 Receiver

The MAX221's receiver converts RS-232 signals to CMOS-logic output levels. The receiver has an inverting

three-state output and can be active or inactive. In shutdown ($\overline{\text{FORCEOFF}} = \text{low}$) or in AutoShutdown, the receiver is active (Table 1). Drive $\overline{\text{EN}}$ high to place the receiver in a high-impedance state. The receiver is high impedance when the MAX221 is in shutdown ($\overline{\text{FORCEOFF}} = \text{low}$).

The MAX221's $\overline{\text{INVALID}}$ output is pulled low when no valid RS-232 signal level is detected on the receiver input. $\overline{\text{INVALID}}$ is functional in any mode (Figures 2 and 3).

AutoShutdown

The MAX221 achieves 1 μ A supply current with Maxim's AutoShutdown feature, which operates when $\overline{\text{FORCEON}}$ is low and $\overline{\text{FORCEOFF}}$ is high. When the device senses no valid signal levels on the receiver input for 30 μ s, the on-board charge pump and driver are shut off, reducing supply current to 1 μ A. This occurs if the RS-232 cable is disconnected or the connected peripheral transmitter is turned off. The MAX221 turns on again when a valid level is applied to the RS-232 receiver input. As a result, the system saves power without changes to the existing BIOS or operating system.

Table 1 and Figure 2c summarize the MAX221 operating modes. $\overline{\text{FORCEON}}$ and $\overline{\text{FORCEOFF}}$ override AutoShutdown. When neither control is asserted, the device selects between these states automatically, based on the receiver input level. Figures 2a, 2b, and 3a depict valid and invalid RS-232 receiver levels. Figure 3 shows the input levels and timing diagram for AutoShutdown operation.

A device or another system with AutoShutdown connected to the MAX221 may need time to wake up. Figure 4 shows a circuit that forces the transmitter on for 100ms, allowing enough time for the other system to realize that the MAX221 is awake. If the other system transmits valid RS-232 signals within that time, the RS-232 ports on both systems remain enabled.

When shut down, the device's charge pumps are off, V+ is pulled to VCC, V- is pulled to ground, and the transmitter output is high impedance. The time required to exit shutdown is typically 100 μ s (Figure 3b).

Software-Controlled Shutdown

For direct software control, use $\overline{\text{INVALID}}$ to indicate a DTR or Ring Indicator signal. Connect $\overline{\text{FORCEOFF}}$ and $\overline{\text{FORCEON}}$ together to disable AutoShutdown so the line acts like a $\overline{\text{SHDN}}$ input.

+5V, 1μA, Single RS-232 Transceiver with AutoShutdown

Table 1. Output Control Truth Table

OPERATION STATUS	FORCEON	FORCEOFF	EN	VALID RECEIVER LEVEL	TOUT	ROUT
Shutdown (Forced Off)	X	0	0	X	High-Z	Active
	X	0	1	X	High-Z	High-Z
Normal Operation (Forced On)	1	1	0	X	Active	Active
	1	1	1	X	Active	High-Z
Normal Operation (AutoShutdown)	0	1	0	Yes	Active	Active
	0	1	1	Yes	Active	High-Z
Shutdown (AutoShutdown)	0	1	0	No	High-Z	Active
	0	1	1	No	High-Z	High-Z

X = Don't care



Figure 2a. Entering 1μA Supply Mode via AutoShutdown



Figure 2c. AutoShutdown Logic

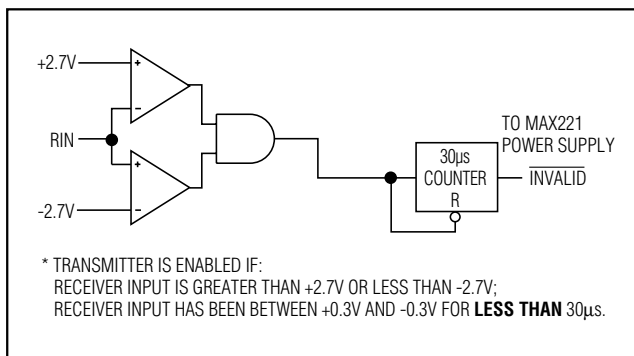

Figure 2b. Transmitter Enabled Using AutoShutdown

Table 2. INVALID Truth Table

RS-232 SIGNAL PRESENT AT RECEIVER INPUT	INVALID OUTPUT
Yes	High
No	Low

+5V, 1 μ A, Single RS-232 Transceiver with AutoShutdown

MAX221

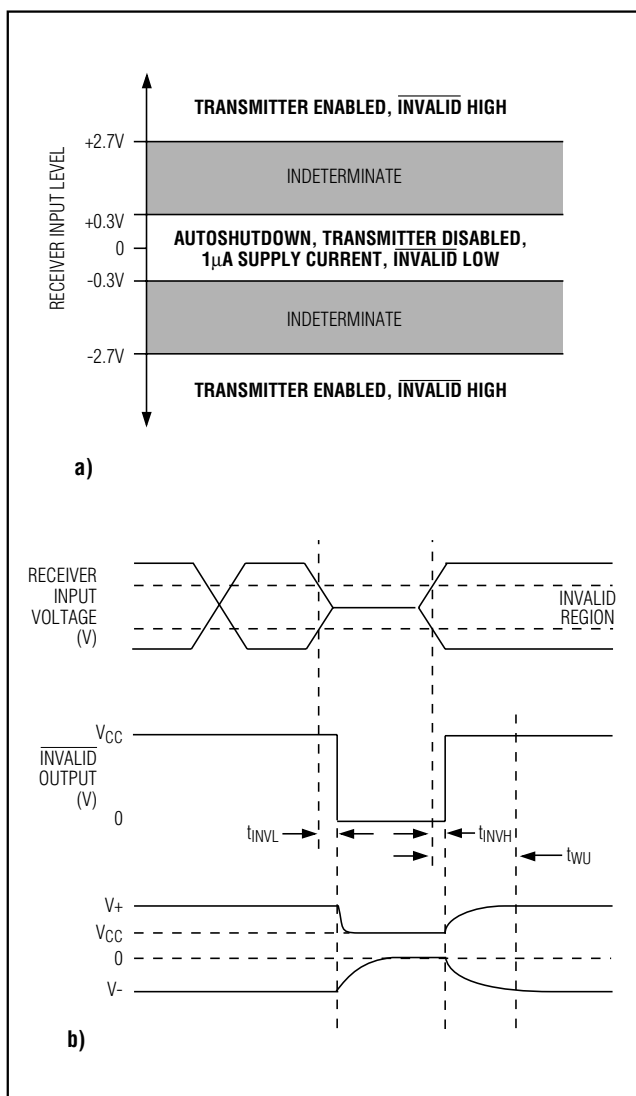

Figure 3. AutoShutdown Trip Levels

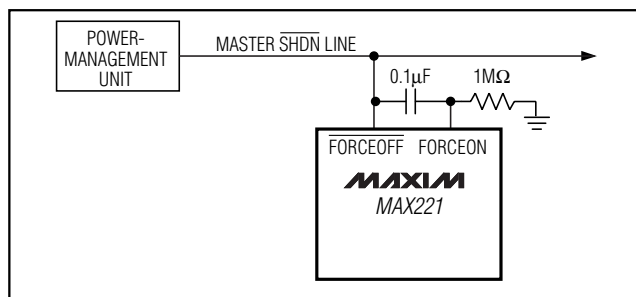

Figure 4. AutoShutdown with Initial Turn-On to Wake Up a Mouse or Another System

Applications Information

Using INVALID

INVALID indicates when an RS-232 signal is present at the receiver input, and therefore when the port is in use. INVALID can be used in alternative shutdown control schemes where it relieves the processor from constantly polling the port for activity.

Capacitor Selection

The capacitor type used for C1–C4 is not critical for proper operation; either polarized or nonpolarized capacitors are acceptable. If polarized capacitors are used, connect polarity as shown in the *Typical Operating Circuit*. The charge pump requires 0.1 μ F capacitors. Increasing the capacitor values (e.g., by a factor of 2) reduces ripple on the transmitter output and slightly reduces power consumption. C2, C3, and C4 can be increased without changing C1's value. However, do not increase C1's value without also increasing the values of C2, C3, and C4 to maintain the proper ratios (C1 to the other capacitors).

When using the minimum 0.1 μ F capacitors, make sure the capacitance does not degrade excessively with temperature. If in doubt, use capacitors with a larger nominal value. The capacitor's equivalent series resistance (ESR) usually rises at low temperatures and influences the amount of ripple on V+ and V-.

Power-Supply Decoupling

In most circumstances, a 0.1 μ F VCC bypass capacitor is adequate. In applications that are sensitive to power-supply noise, use a capacitor of the same value as the charge-pump capacitor C1. Connect bypass capacitors as close to the IC as possible.

Transmitter Output when Exiting Shutdown

Figure 5 shows the transmitter output when exiting shutdown mode. The transmitter is loaded with 3k Ω in parallel with 250pF. The transmitter output displays no ringing or undesirable transients as the MAX221 comes out of shutdown. Note that the transmitter is enabled only when the magnitude of V- exceeds approximately 3V.

High Data Rates

The MAX221 maintains the RS-232 ± 5.0 V minimum transmitter output voltage even at high data rates. Figure 6 shows a transmitter loopback test circuit. Figure 7 shows the loopback test result at 120kbps, and Figure 8 shows the same test at 250kbps.