

## MAX22245, MAX22246

## Reinforced, Fast, Low-Power, Two-Channel Digital Isolators

### Product Highlights

- **AEC-Q100 Qualification for I/V devices**
- Reinforced Galvanic Isolation for Digital Signals
  - 8-SOIC with 8mm of Creepage and Clearance
  - Withstands  $5kV_{RMS}$  for 60s ( $V_{ISO}$ )
  - Continuously Withstands  $848V_{RMS}$  ( $V_{IOWM}$ )
  - Withstands  $\pm 12.8kV$  Surge Between GNDA and GNDB with 1.2/50 $\mu s$  Waveform
  - High CMTI (50kV/ $\mu s$ , typ)
- Low Power Consumption
  - 0.78mW per Channel at 1Mbps with  $V_{DD\_} = 1.8V$
  - 1.47mW per Channel at 1Mbps with  $V_{DD\_} = 3.3V$
  - 3.28mW per Channel at 100Mbps with  $V_{DD\_} = 1.8V$
- Low Propagation Delay and Low Jitter
  - Maximum Data Rate Up to 200Mbps
  - Low Propagation Delay 7ns (typ) at  $V_{DD\_} = 3.3V$
  - Clock Jitter RMS 7.5ps (typ)
- Safety Regulatory Approvals
  - UL According to UL1577
  - cUL According to CSA Bulletin 5A
  - VDE 0884-11 Reinforced Insulation (Pending)

### Key Applications

- Automotive
  - Hybrid Electric Vehicle
  - Chargers
  - Battery Management Systems (BMS)
  - Inverters

The MAX22245/MAX22246 are a family of 2-channel reinforced, fast, low-power digital galvanic isolators using Analog Devices' proprietary process technology. All devices feature reinforced isolation for a withstand voltage rating of  $5kV_{RMS}$  for 60 seconds. Both automotive and general-purpose devices are rated for operation at ambient temperatures of  $-40^{\circ}C$  to  $+125^{\circ}C$ .

Devices with I/V suffix are AEC-Q100 qualified. Refer to the [Ordering Information](#) for all automotive grade part numbers.

- Industrial
  - Isolated SPI
  - Isolated RS-232, RS-485/RS-422, CAN
  - Fieldbus Communications

- Motor Drive

### Simplified Application Diagram

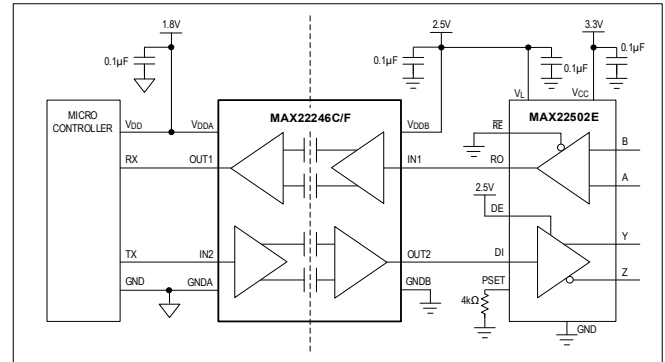

### Pin Description

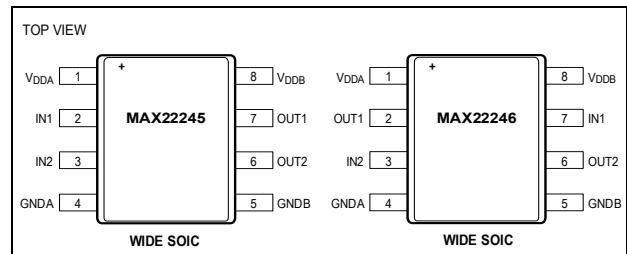

These devices transfer digital signals between circuits with different power domains, using as little as 0.78mW per-channel at 1Mbps (1.8V supply). The low-power feature reduces system dissipation, increases reliability, and enables compact designs.

Devices are available with a maximum data rate of 25Mbps or 200Mbps, and with outputs that are either default high or default low. The devices feature low propagation delay and low clock jitter, which reduces system latency.

Independent 1.71V to 5.5V supplies on each side of the isolator also make the devices suitable for use as level translators.

The MAX22245 features two channels transferring data in the same direction. The two channels of the MAX22246 transfer data in opposite directions, and this makes the MAX22246 ideal for isolating the Tx and Rx lines of a transceiver.

[Ordering Information](#) appears at end of data sheet.

## Absolute Maximum Ratings

V <sub>DDA</sub> to GNDA.....	-0.3V to +6V	OUT_ on Side B to GNDB.....	±30mA
V <sub>ddb</sub> to GNDB.....	-0.3V to +6V	Continuous Power Dissipation (T <sub>A</sub> = +70°C)	
IN_ on Side A to GNDA .....	-0.3V to +6V	Wide SOIC (derate 11.35mW/°C above +70°C) ...	908.1mW
IN_ on Side B to GNDB .....	-0.3V to +6V	Temperature Ratings	
OUT_ on Side A to GNDA .....	-0.3V to (V <sub>DDA</sub> + 0.3V)	Operating Temperature Range.....	-40°C to +125°C
OUT_ on Side B to GNDB .....	-0.3V to (V <sub>ddb</sub> + 0.3V)	Maximum Junction Temperature .....	+150°C
Short-Circuit Continuous Current		Storage Temperature Range.....	-60°C to +150°C
OUT_ on Side A to GNDA .....	±30mA	Lead Temperature (soldering, 10s).....	+300°C
		Soldering Temperature (reflow).....	+260°C

Stresses beyond those listed under "Absolute Maximum Ratings" may cause permanent damage to the device. These are stress ratings only, and functional operation of the device at these or any other conditions beyond those indicated in the operational sections of the specifications is not implied. Exposure to absolute maximum rating conditions for extended periods may affect device reliability.

## Package Information

### 8 Wide SOIC

<b>PACKAGE CODE</b>	W8MS+7
Outline Number	<a href="#">21-100415</a>
Land Pattern Number	<a href="#">90-100146</a>
<b>THERMAL RESISTANCE, FOUR-LAYER BOARD</b>	
Junction-to-Ambient (θ <sub>JA</sub> )	88.1°C/W
Junction-to-Case Thermal Resistance (θ <sub>JC</sub> )	42.4°C/W

Package thermal resistances were obtained using the method described in JEDEC specification JESD51-7, using a four-layer board. For detailed information on package thermal considerations, refer to [www.maximintegrated.com/thermal-tutorial](http://www.maximintegrated.com/thermal-tutorial).

For the latest package outline information and land patterns (footprints), go to [www.maximintegrated.com/packages](http://www.maximintegrated.com/packages). Note that a "+", "#", or "-" in the package code indicates RoHS status only. Package drawings may show a different suffix character, but the drawing pertains to the package regardless of RoHS status.

**Electrical Characteristics**

( $V_{DDA} - V_{GNDA} = 1.71V$  to  $5.5V$ ,  $V_{DDB} - V_{GNDB} = 1.71V$  to  $5.5V$ ,  $C_L = 15pF$ ,  $T_A = -40^{\circ}C$  to  $+125^{\circ}C$ , unless otherwise noted. Typical values are at  $V_{DDA} - V_{GNDA} = 3.3V$ ,  $V_{DDB} - V_{GNDB} = 3.3V$ ,  $V_{GNDA} = V_{GNDB}$ ,  $T_A = +25^{\circ}C$ , unless otherwise noted.) (Note 1) (Note 3)

PARAMETER	SYMBOL	CONDITIONS	MIN	TYP	MAX	UNITS
<b>SUPPLY VOLTAGE</b>						
Supply Voltage	$V_{DDA}$	Relative to GNDA	1.71		5.5	V
	$V_{DDB}$	Relative to GNDB	1.71		5.5	
Undervoltage-Lockout Threshold	$V_{UVLO\_}$	$V_{DD\_}$ rising	1.5	1.6	1.66	V
Undervoltage-Lockout Threshold Hysteresis	$V_{UVLO\_HYST}$			45		mV
<b>MAX22245 SUPPLY CURRENT (Note 2)</b>						
Side A Supply Current	$I_{DDA}$	500kHz square wave, $C_L = 0pF$	$V_{DDA} = 5V$	0.31	0.57	mA
			$V_{DDA} = 3.3V$	0.30	0.56	
			$V_{DDA} = 2.5V$	0.30	0.56	
			$V_{DDA} = 1.8V$	0.29	0.41	
		50MHz square wave, $C_L = 0pF$	$V_{DDA} = 5V$	2.38	3.25	
			$V_{DDA} = 3.3V$	2.32	3.18	
			$V_{DDA} = 2.5V$	2.29	3.14	
			$V_{DDA} = 1.8V$	2.22	2.89	
Side B Supply Current	$I_{DDB}$	500kHz square wave, $C_L = 0pF$	$V_{DDB} = 5V$	0.60	1.11	mA
			$V_{DDB} = 3.3V$	0.59	1.10	
			$V_{DDB} = 2.5V$	0.59	1.09	
			$V_{DDB} = 1.8V$	0.58	1.06	
		50MHz square wave, $C_L = 0pF$	$V_{DDB} = 5V$	3.02	3.80	
			$V_{DDB} = 3.3V$	2.12	2.80	
			$V_{DDB} = 2.5V$	1.74	2.35	
			$V_{DDB} = 1.8V$	1.42	1.95	
<b>MAX22246 SUPPLY CURRENT (Note 2)</b>						
Side A Supply Current	$I_{DDA}$	500kHz square wave, $C_L = 0pF$	$V_{DDA} = 5V$	0.46	0.84	mA
			$V_{DDA} = 3.3V$	0.45	0.83	
			$V_{DDA} = 2.5V$	0.44	0.83	
			$V_{DDA} = 1.8V$	0.44	0.74	
		50MHz square wave, $C_L = 0pF$	$V_{DDA} = 5V$	2.65	3.50	
			$V_{DDA} = 3.3V$	2.18	2.95	
			$V_{DDA} = 2.5V$	1.98	2.72	
			$V_{DDA} = 1.8V$	1.80	2.40	
Side B Supply Current	$I_{DDB}$	500kHz square wave, $C_L = 0pF$	$V_{DDB} = 5V$	0.46	0.84	mA
			$V_{DDB} = 3.3V$	0.45	0.83	
			$V_{DDB} = 2.5V$	0.44	0.83	
			$V_{DDB} = 1.8V$	0.44	0.74	
		50MHz square wave, $C_L = 0pF$	$V_{DDB} = 5V$	2.65	3.50	
			$V_{DDB} = 3.3V$	2.18	2.95	

( $V_{DDA} - V_{GNDA} = 1.71V$  to  $5.5V$ ,  $V_{DDB} - V_{GNDB} = 1.71V$  to  $5.5V$ ,  $C_L = 15pF$ ,  $T_A = -40^\circ C$  to  $+125^\circ C$ , unless otherwise noted. Typical values are at  $V_{DDA} - V_{GNDA} = 3.3V$ ,  $V_{DDB} - V_{GNDB} = 3.3V$ ,  $V_{GNDA} = V_{GNDB}$ ,  $T_A = +25^\circ C$ , unless otherwise noted.) (Note 1) (Note 3)

PARAMETER	SYMBOL	CONDITIONS	MIN	TYP	MAX	UNITS
		$V_{DDB} = 2.5V$		1.98	2.72	
		$V_{DDB} = 1.8V$		1.80	2.40	
<b>LOGIC INTERFACE (IN_, OUT_)</b>						
Input High Voltage	$V_{IH}$	$2.25V \leq V_{DD\_} \leq 5.5V$	$0.7 \times V_{DD\_}$			V
		$1.71V \leq V_{DD\_} < 2.25V$	$0.75 \times V_{DD\_}$			
Input Low Voltage	$V_{IL}$	$2.25V \leq V_{DD\_} \leq 5.5V$	0.8			V
		$1.71V \leq V_{DD\_} < 2.25V$	0.7			
Input Hysteresis	$V_{HYS}$	MAX2224_B/E	410			mV
		MAX2224_C/F	80			
Input Pullup Current	$I_{PU}$	MAX2224_B/C	-10	-5	-1.5	$\mu A$
Input Pulldown Current	$I_{PD}$	MAX2224_E/F	1.5	5	10	$\mu A$
Input Capacitance	$C_{IN}$	$f_{SW} = 1MHz$	2			pF
Output Voltage High	$V_{OH}$	$I_{OUT} = -4mA$ source	$V_{DD\_} - 0.4$			V
Output Voltage Low	$V_{OL}$	$I_{OUT} = 4mA$ sink	0.4			V

### Dynamic Characteristics MAX2224\_C/F

( $V_{DDA} - V_{GNDA} = 1.71V$  to  $5.5V$ ,  $V_{DDB} - V_{GNDB} = 1.71V$  to  $5.5V$ ,  $C_L = 15pF$ ,  $T_A = -40^\circ C$  to  $+125^\circ C$ , unless otherwise noted. Typical values are at  $V_{DDA} - V_{GNDA} = 3.3V$ ,  $V_{DDB} - V_{GNDB} = 3.3V$ ,  $V_{GNDA} = V_{GNDB}$ ,  $T_A = +25^\circ C$ , unless otherwise noted.) (Note 2) (Note 4)

PARAMETER	SYMBOL	CONDITIONS	MIN	TYP	MAX	UNITS	
Common-Mode Transient Immunity	CMTI	$IN\_ = GND\_$ or $V_{DD\_}$ (Note 5)	50			kV/ $\mu s$	
Maximum Data Rate	$DR_{MAX}$	$2.25V \leq V_{DD\_} \leq 5.5V$	200			Mbps	
		$1.71V \leq V_{DD\_} < 2.25V$	150				
Minimum Pulse Width	$PW_{MIN}$	$2.25V \leq V_{DD\_} \leq 5.5V$	5			ns	
		$1.71V \leq V_{DD\_} < 2.25V$	6.67				
Propagation Delay ( <a href="#">Figure 1</a> )	$t_{PLH}$	$IN\_ \text{ to } OUT\_$ , $C_L = 15pF$	$4.5V \leq V_{DD\_} \leq 5.5V$	4.4	6.2	9.5	ns
			$3.0V \leq V_{DD\_} \leq 3.6V$	4.8	7.0	11.2	
			$2.25V \leq V_{DD\_} \leq 2.75V$	5.3	8.3	14.7	
			$1.71V \leq V_{DD\_} \leq 1.89V$	7.1	12.3	22.1	
	$t_{PHL}$	$IN\_ \text{ to } OUT\_$ , $C_L = 15pF$	$4.5V \leq V_{DD\_} \leq 5.5V$	4.6	6.5	9.9	
			$3.0V \leq V_{DD\_} \leq 3.6V$	5.0	7.3	11.6	
			$2.25V \leq V_{DD\_} \leq 2.75V$	5.4	8.5	14.9	
			$1.71V \leq V_{DD\_} \leq 1.89V$	7.2	12.1	21.8	
Pulse Width Distortion	PWD	$ t_{PLH} - t_{PHL} $	$4.5V \leq V_{DD\_} \leq 5.5V$	0.4		ns	
			$3.0V \leq V_{DD\_} \leq 3.6V$	0.4			
			$2.25V \leq V_{DD\_} \leq 2.75V$	0.3			
			$2.25V \leq V_{DD\_} \leq 2.75V$	2			

( $V_{DDA} - V_{GNDA} = 1.71V$  to  $5.5V$ ,  $V_{DDB} - V_{GNDB} = 1.71V$  to  $5.5V$ ,  $C_L = 15pF$ ,  $T_A = -40^\circ C$  to  $+125^\circ C$ , unless otherwise noted. Typical values are at  $V_{DDA} - V_{GNDA} = 3.3V$ ,  $V_{DDB} - V_{GNDB} = 3.3V$ ,  $V_{GNDA} = V_{GNDB}$ ,  $T_A = +25^\circ C$ , unless otherwise noted.) (Note 2) (Note 4)

PARAMETER	SYMBOL	CONDITIONS		MIN	TYP	MAX	UNITS
			$1.71V \leq V_{DD\_} \leq 1.89V$		0.0	2	
Propagation Delay Skew Part-to-Part (Same Channel)	$t_{SPLH}$	$4.5V \leq V_{DD\_} \leq 5.5V$				3.7	ns
		$3.0V \leq V_{DD\_} \leq 3.6V$				4.7	
		$2.25V \leq V_{DD\_} \leq 2.75V$				6.9	
		$1.71V \leq V_{DD\_} \leq 1.89V$				12.1	
	$t_{SPHL}$	$4.5V \leq V_{DD\_} \leq 5.5V$				4.0	
		$3.0V \leq V_{DD\_} \leq 3.6V$				4.9	
		$2.25V \leq V_{DD\_} \leq 2.75V$				7.0	
		$1.71V \leq V_{DD\_} \leq 1.89V$				11.8	
Propagation Delay Skew Channel-to-Channel (Same Direction) (Figure 1)	$t_{SCSLH}$	$1.71V \leq V_{DD\_} \leq 5.5V$				2	ns
	$t_{SCSHL}$	$1.71V \leq V_{DD\_} \leq 5.5V$				2	
Propagation Delay Skew Channel-to-Channel (Opposite Direction)	$t_{SCOLH}$	$1.71V \leq V_{DD\_} \leq 5.5V$				2	ns
	$t_{SCOHL}$	$1.71V \leq V_{DD\_} \leq 5.5V$				2	
Peak Eye Diagram Jitter	$t_{JIT(PK)}$	200Mbps			100		ps
Clock Jitter RMS	$t_{JCLK(RMS)}$	500kHz clock input, rising/falling edges			7.5		ps
Rise Time (Figure 1)	$t_R$	$C_L = 5pF$	$4.5V \leq V_{DD\_} \leq 5.5V$			0.8	ns
			$3.0V \leq V_{DD\_} \leq 3.6V$			1.1	
			$2.25V \leq V_{DD\_} \leq 2.75V$			1.5	
			$1.71V \leq V_{DD\_} \leq 1.89V$			2.4	
Fall Time (Figure 1)	$t_F$	$C_L = 5pF$	$4.5V \leq V_{DD\_} \leq 5.5V$			1	ns
			$3.0V \leq V_{DD\_} \leq 3.6V$			1.4	
			$2.25V \leq V_{DD\_} \leq 2.75V$			1.9	
			$1.71V \leq V_{DD\_} \leq 1.89V$			3	

### Dynamic Characteristics MAX2224\_B/E

( $V_{DDA} - V_{GNDA} = 1.71V$  to  $5.5V$ ,  $V_{DDB} - V_{GNDB} = 1.71V$  to  $5.5V$ ,  $C_L = 15pF$ ,  $T_A = -40^\circ C$  to  $+125^\circ C$ , unless otherwise noted. Typical values are at  $V_{DDA} - V_{GNDA} = 3.3V$ ,  $V_{DDB} - V_{GNDB} = 3.3V$ ,  $V_{GNDA} = V_{GNDB}$ ,  $T_A = +25^\circ C$ , unless otherwise noted.) (Note 2) (Note 4)

PARAMETER	SYMBOL	CONDITIONS		MIN	TYP	MAX	UNITS
Common-Mode Transient Immunity	CMTI	$IN\_ = GND\_$ or $V_{DD\_}$ (Note 5)			50		kV/ $\mu s$
Maximum Data Rate	$DR_{MAX}$			25			Mbps
Minimum Pulse Width	$PW_{MIN}$					40	ns
Glitch Rejection				10	17	29	ns
Propagation Delay (Figure 1)	$t_{PLH}$	$IN\_ \text{ to } OUT\_$ , $C_L = 15pF$	$4.5V \leq V_{DD\_} \leq 5.5V$	16.7	22.6	30.7	ns
			$3.0V \leq V_{DD\_} \leq 3.6V$	17.0	23.4	32.2	

( $V_{DDA} - V_{GNDA} = 1.71V$  to  $5.5V$ ,  $V_{DDB} - V_{GNDB} = 1.71V$  to  $5.5V$ ,  $C_L = 15pF$ ,  $T_A = -40^\circ C$  to  $+125^\circ C$ , unless otherwise noted. Typical values are at  $V_{DDA} - V_{GNDA} = 3.3V$ ,  $V_{DDB} - V_{GNDB} = 3.3V$ ,  $V_{GNDA} = V_{GNDB}$ ,  $T_A = +25^\circ C$ , unless otherwise noted.) (Note 2) (Note 4)

PARAMETER	SYMBOL	CONDITIONS		MIN	TYP	MAX	UNITS
	$t_{PHL}$	IN <sub>-</sub> to OUT <sub>-</sub> , $C_L = 15pF$	$2.25V \leq V_{DD-} \leq 2.75V$	17.7	24.8	35.3	
			$1.71V \leq V_{DD-} \leq 1.89V$	19.6	28.8	42.8	
			$4.5V \leq V_{DD-} \leq 5.5V$	16.4	22.7	32.1	
			$3.0V \leq V_{DD-} \leq 3.6V$	16.8	23.5	33.8	
			$2.25V \leq V_{DD-} \leq 2.75V$	17.3	24.8	36.7	
			$1.71V \leq V_{DD-} \leq 1.89V$	19.0	28.4	43.7	
Pulse Width Distortion	PWD	$ t_{PLH} - t_{PHL} $	$4.5V \leq V_{DD-} \leq 5.5V$		0.1	4	ns
			$3.0V \leq V_{DD-} \leq 3.6V$		0.1	4	
			$2.25V \leq V_{DD-} \leq 2.75V$		0.0	4	
			$1.71V \leq V_{DD-} \leq 1.89V$		0.4	4	
Propagation Delay Skew Part-to-Part (Same Channel)	$t_{SPLH}$		$4.5V \leq V_{DD-} \leq 5.5V$			14.0	ns
			$3.0V \leq V_{DD-} \leq 3.6V$			13.8	
			$2.25V \leq V_{DD-} \leq 2.75V$			15.2	
			$1.71V \leq V_{DD-} \leq 1.89V$			21.9	
	$t_{SPHL}$		$4.5V \leq V_{DD-} \leq 5.5V$			13.0	
			$3.0V \leq V_{DD-} \leq 3.6V$			13.5	
			$2.25V \leq V_{DD-} \leq 2.75V$			15.4	
			$1.71V \leq V_{DD-} \leq 1.89V$			21.4	
Propagation Delay Skew Channel-to-Channel (Same Direction) (Figure 1)	$t_{SCSLH}$		$1.71V \leq V_{DD-} \leq 5.5V$			4	ns
	$t_{SCSHL}$		$1.71V \leq V_{DD-} \leq 5.5V$			4	
Propagation Delay Skew Channel-to-Channel (Opposite Direction)	$t_{SCOLH}$		$1.71V \leq V_{DD-} \leq 5.5V$			4	ns
	$t_{SCOHL}$		$1.71V \leq V_{DD-} \leq 5.5V$			4	
Peak Eye Diagram Jitter	$t_{JIT(PK)}$		25Mbps		250		ps
Rise Time (Figure 1)	$t_R$	$C_L = 5pF$	$4.5V \leq V_{DD-} \leq 5.5V$			0.8	ns
			$3.0V \leq V_{DD-} \leq 3.6V$			1.1	
			$2.25V \leq V_{DD-} \leq 2.75V$			1.5	
			$1.71V \leq V_{DD-} \leq 1.89V$			2.4	
Fall Time (Figure 1)	$t_F$	$C_L = 5pF$	$4.5V \leq V_{DD-} \leq 5.5V$			1	ns
			$3.0V \leq V_{DD-} \leq 3.6V$			1.4	
			$2.25V \leq V_{DD-} \leq 2.75V$			1.9	
			$1.71V \leq V_{DD-} \leq 1.89V$			3	

- Note 1:** General purpose devices are 100% production tested at  $T_A = +25^\circ\text{C}$ . Specifications over temperature are guaranteed by design and characterization. Automotive devices are 100% production tested at  $T_A = +25^\circ\text{C}$  and  $T_A = +125^\circ\text{C}$ .
- Note 2:** Not production tested. Guaranteed by design and characterization.
- Note 3:** All currents into the device are positive. All currents out of the device are negative. All voltages are referenced to their respective ground (GNDA or GNDB), unless otherwise noted.
- Note 4:** All measurements taken with  $V_{DDA} = V_{DDB}$ , unless otherwise noted.
- Note 5:** CMTI is the maximum sustainable common-mode voltage slew rate while maintaining the correct output. CMTI applies to both rising and falling common-mode voltage edges. Tested with the transient generator connected between GNDA and GNDB ( $V_{CM} = 1000\text{V}$ ).

### ESD Protection

( $T_A = +25^\circ\text{C}$ )

PARAMETER	SYMBOL	CONDITIONS	VALUE	UNITS
ESD		Human Body Model, All Pins	$\pm 3$	kV
		IEC 61000-4-2 Contact, GNDB to GNDA	$\pm 7$	

### Test Circuit and Timing Diagram

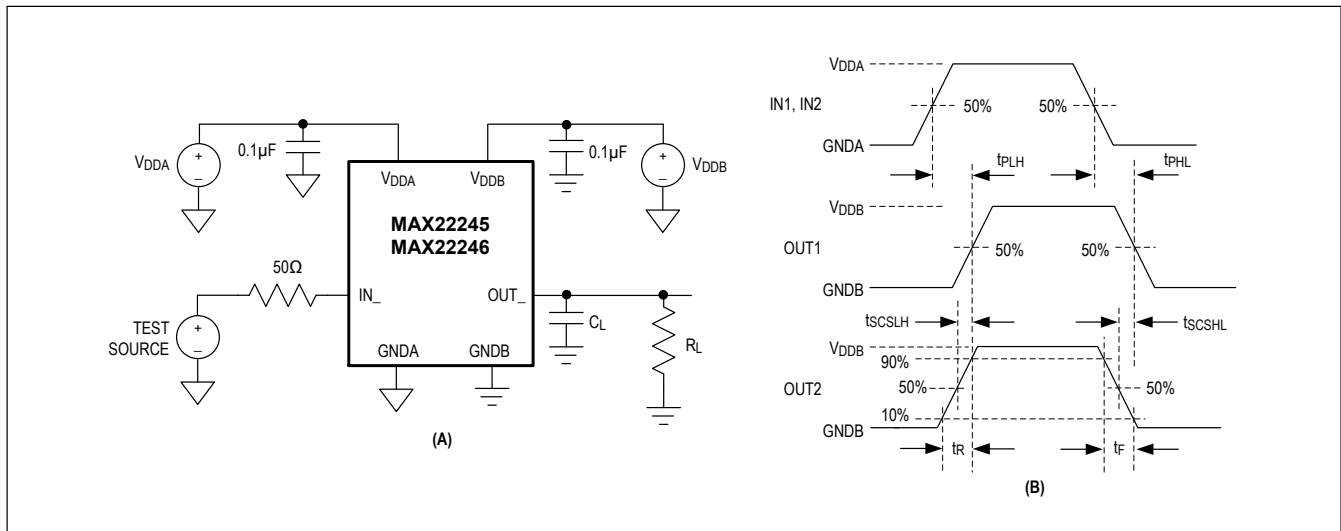

Figure 1. Test Circuit (A) and Timing Diagram (B)

**Table 1. Insulation Characteristics**

PARAMETER	SYMBOL	CONDITIONS	VALUE	UNITS
Partial Discharge Test Voltage	$V_{PR}$	Method B1 = $V_{IORM} \times 1.875$ ( $t = 1s$ , partial discharge < 5pC)	3977	$V_P$
Maximum Repetitive Peak Isolation Voltage	$V_{IORM}$	(Note 6)	1200	$V_P$
Maximum Working Isolation Voltage	$V_{IOWM}$	Continuous RMS voltage (Note 6)	848	$V_{RMS}$
Maximum Transient Isolation Voltage	$V_{IOTM}$	$t = 1s$ (Note 6)	7000	$V_P$
Maximum Withstanding Isolation Voltage	$V_{ISO}$	$f_{SW} = 60Hz$ , duration = 60s (Note 6) (Note 7)	5000	$V_{RMS}$
Maximum Surge Isolation Voltage	$V_{IOSM}$	Reinforced Insulation, test method per IEC 60065, $V_{TEST} = 1.6 \times V_{IOSM} = 12800V_{PEAK}$ (Note 6) (Note 9)	8000	$V_P$
Isolation Resistance	$R_{IO}$	$V_{IO} = 500V$ , $T_A = 25^\circ C$	$> 10^{12}$	$\Omega$
		$V_{IO} = 500V$ , $100^\circ C \leq T_A \leq 125^\circ C$	$> 10^{11}$	
		$V_{IO} = 500V$ , $T_S = 150^\circ C$	$> 10^9$	
Barrier Capacitance Side A to Side B	$C_{IO}$	$f_{SW} = 1MHz$ (Note 8)	1.5	pF
Minimum Creepage Distance	CPG		8	mm
Minimum Clearance Distance	CLR		8	mm
Internal Clearance		Distance through insulation	0.021	mm
Comparative Tracking Index	CTI	Material Group II (IEC 60112)	> 400	
Climate Category			40/125/21	
Pollution Degree (DIN VDE 0110, Table 1)			2	

**Note 6:**  $V_{ISO}$ ,  $V_{IOTM}$ ,  $V_{IOWM}$ ,  $V_{IORM}$  and  $V_{IOSM}$  are defined by the IEC 60747-5-5 standard.

**Note 7:** Product is qualified at  $V_{ISO}$  for 60s and 100% production tested at 120% of  $V_{ISO}$  for 1s.

**Note 8:** Capacitance is measured with all pins on field-side and logic-side tied together.

**Note 9:** Devices are immersed in oil during surge characterization.



### Safety Regulatory Approvals

<b>UL</b>
The MAX22245/MAX22246 are certified under UL1577. For more details, refer to File E351759.
Rated up to 5000V <sub>RMS</sub> isolation voltage for single protection.
<b>cUL (Equivalent to CSA notice 5A)</b>
The MAX22245/MAX22246 are certified up to 5000V <sub>RMS</sub> for single protection. For more details, refer to File E351759.
<b>VDE (Pending)</b>
The MAX22245/MAX22246 are certified to DIN VDE V 0884-11: 2017-1. Reinforced Insulation, Maximum Transient Isolation Voltage 7000V <sub>PK</sub> , Maximum Repetitive Peak Isolation Voltage 1200V <sub>PK</sub> .

*These couplers are suitable for safe electrical insulation only within the safety ratings. Compliance with the safety ratings shall be ensured by means of suitable protective circuits.*

### Typical Operating Characteristics

(V<sub>DDA</sub> - V<sub>GNDA</sub> = +3.3V, V<sub>DDB</sub> - V<sub>GNDB</sub> = +3.3V, V<sub>GNDA</sub> = V<sub>GNDB</sub>, T<sub>A</sub> = +25°C, unless otherwise noted.)

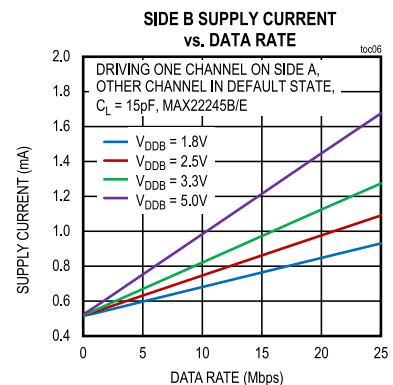
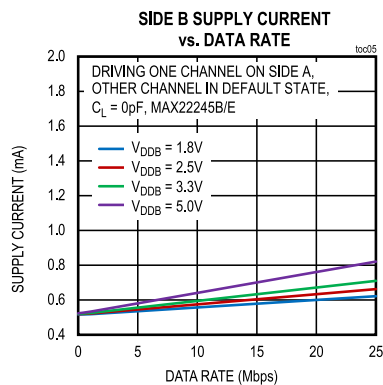
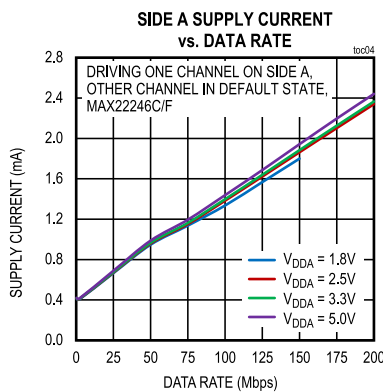
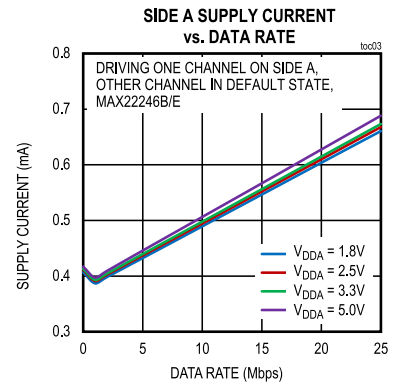
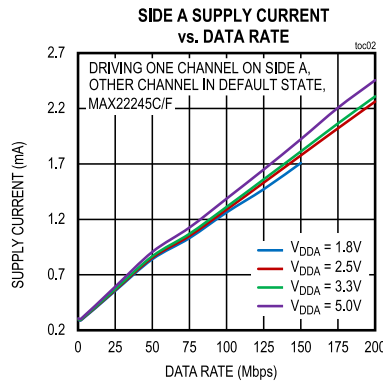
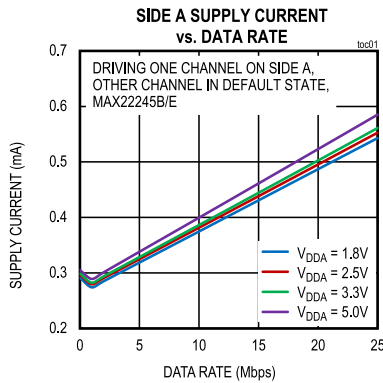

# Reinforced, Fast, Low-Power, Two-Channel Digital Isolators

MAX22245, MAX22246

( $V_{DDA} - V_{GNDA} = +3.3V$ ,  $V_{DDB} - V_{GNDB} = +3.3V$ ,  $V_{GNDA} = V_{GNDB}$ ,  $T_A = +25^\circ C$ , unless otherwise noted.)

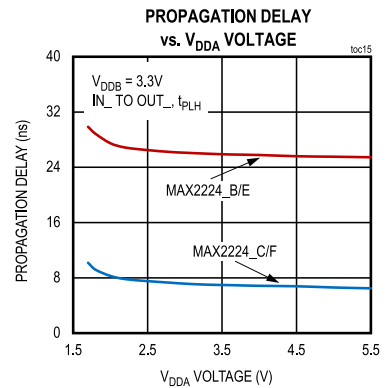
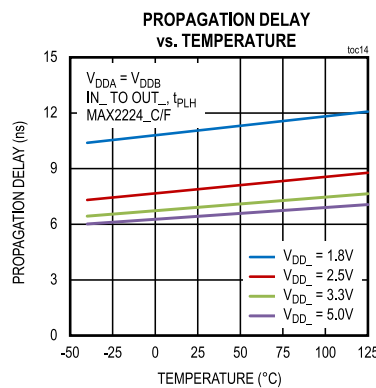
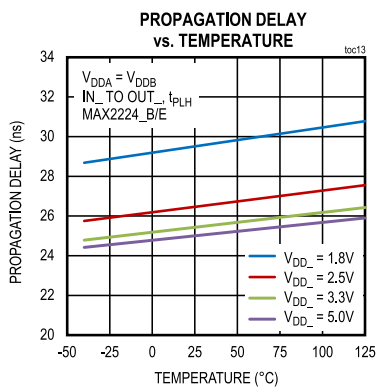
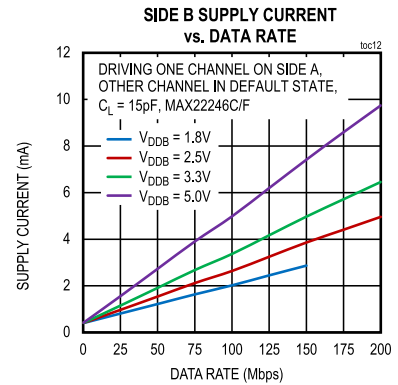
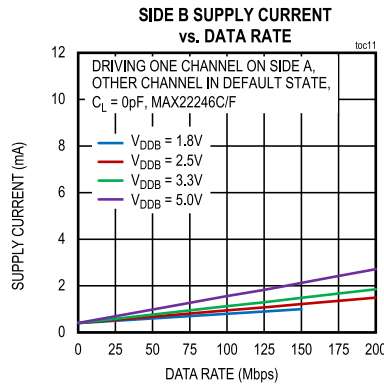
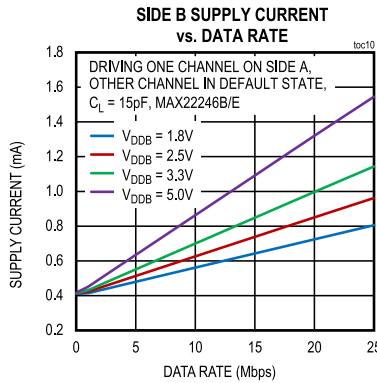
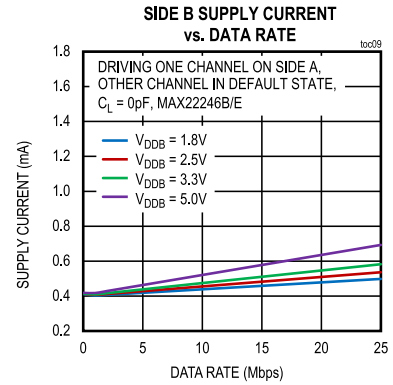
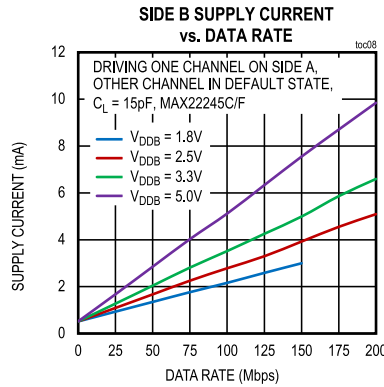
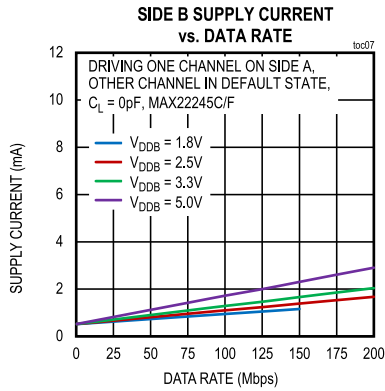

( $V_{DDA} - V_{GNDA} = +3.3V$ ,  $V_{DDB} - V_{GNDB} = +3.3V$ ,  $V_{GNDA} = V_{GNDB}$ ,  $T_A = +25^\circ C$ , unless otherwise noted.)

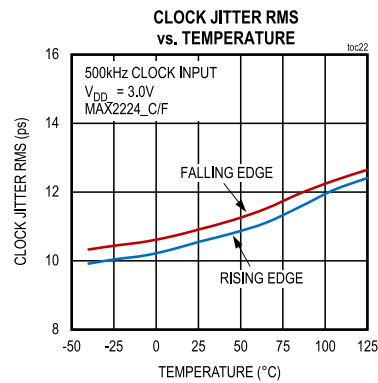
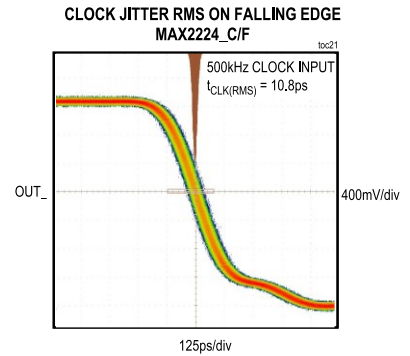
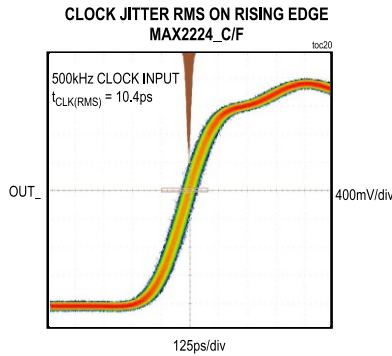
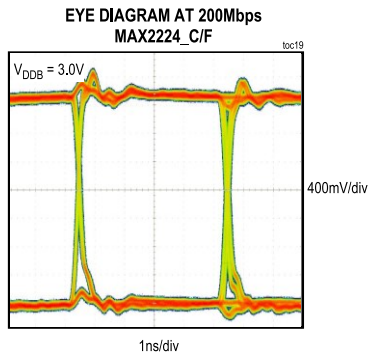
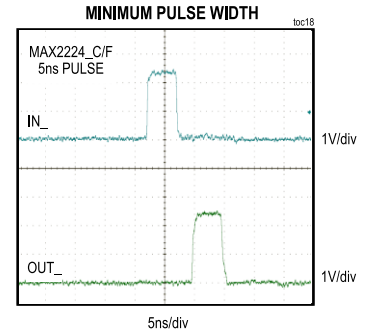
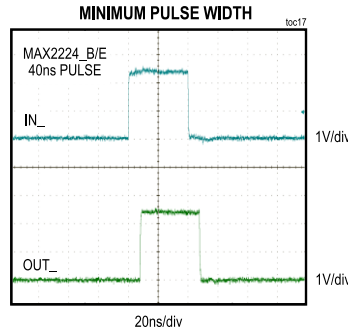
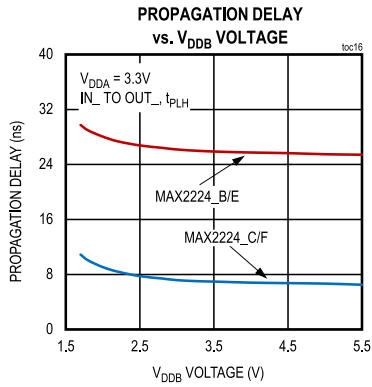

## Pin Configurations

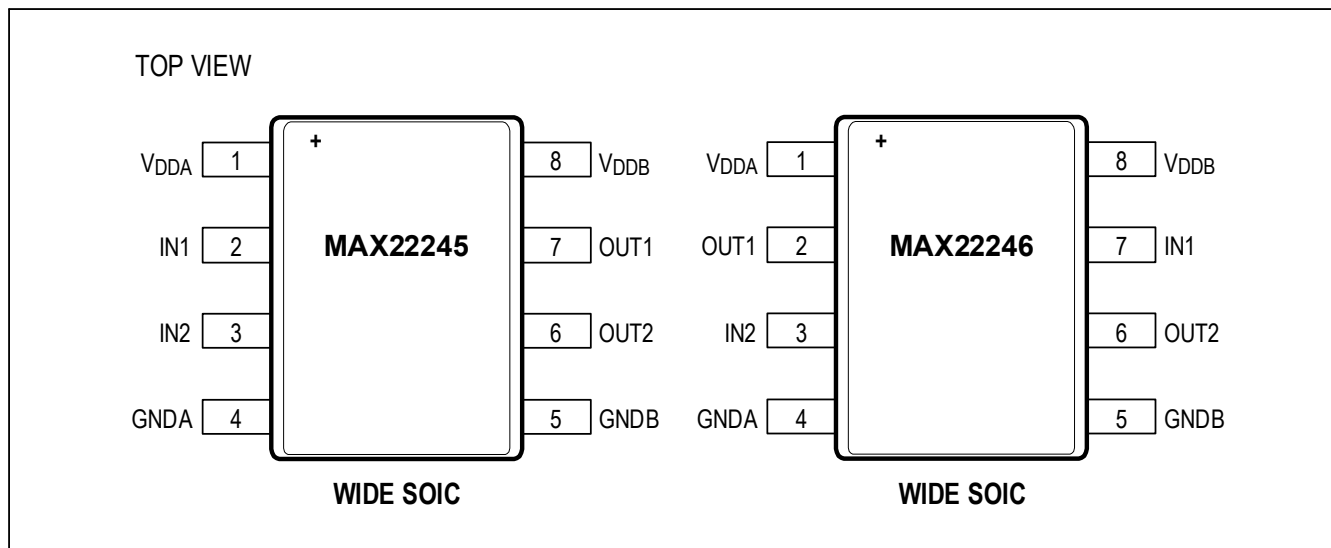

## Pin Descriptions

PIN		NAME	FUNCTION
MAX22245	MAX22246		
1	1	V <sub>DDA</sub>	Power Supply Input for Side A. Bypass V <sub>DDA</sub> to GNDA with a 0.1µF ceramic capacitor as close as possible to the pin.
2	—	IN1	Logic Input 1 on Side A
—	2	OUT1	Logic Output 1 on Side A
3	3	IN2	Logic Input 2 on Side A
4	4	GNDA	Ground Reference for Side A
5	5	GNDB	Ground Reference for Side B
6	6	OUT2	Logic Output 2 on Side B
7	—	OUT1	Logic Output 1 on Side B
—	7	IN1	Logic Input 1 on Side B
8	8	V <sub>DDB</sub>	Power Supply Input for Side B. Bypass V <sub>DDB</sub> to GNDB with a 0.1µF ceramic capacitor as close as possible to the pin.

Functional Diagrams

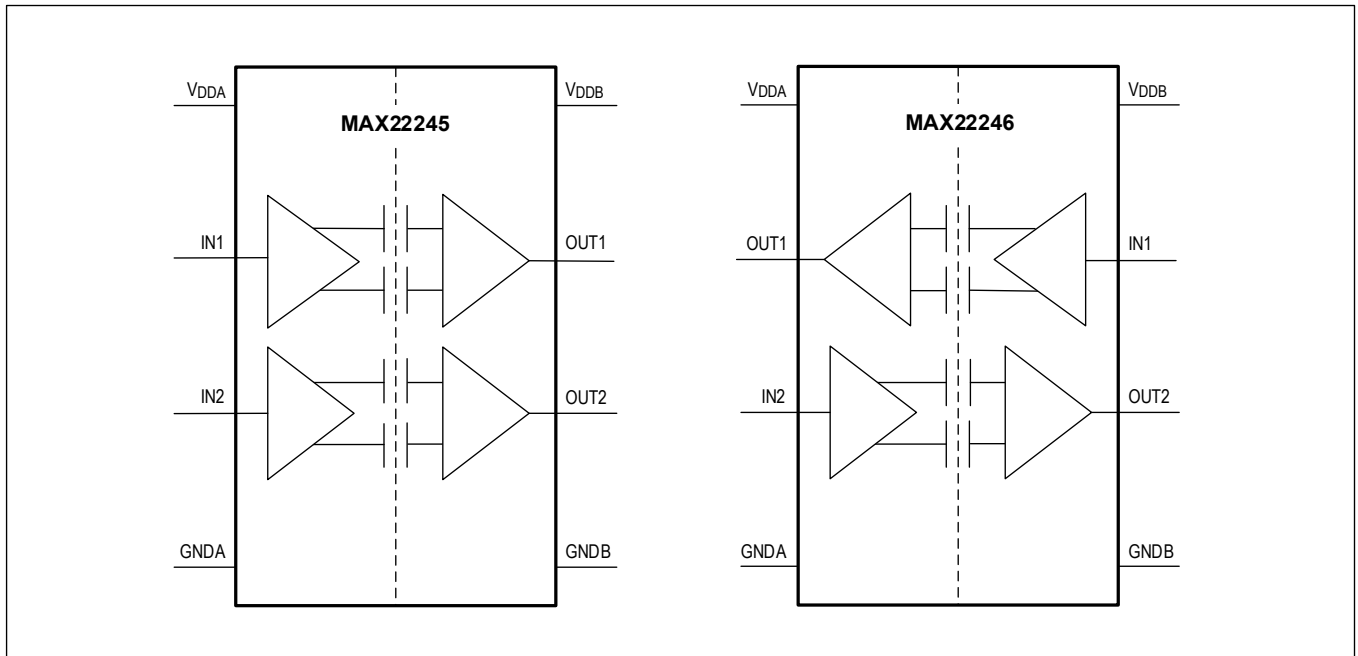

## Detailed Description

The MAX22245/MAX22246 are a family of 2-channel reinforced digital isolators. The MAX22245/MAX22246 have an isolation rating of 5kV<sub>RMS</sub>. The MAX22245/MAX22246 family offers two unidirectional channel configurations to accommodate any 2-channel design.

The MAX22245 features two channels transferring digital signals in one direction for applications such as isolated digital I/O. The MAX22246 has one channel to transmit data in one direction and the other channel to transmit in the opposite direction, making it ideal for applications such as isolated RS232 or RS485 communication.

Devices are available in an 8-pin wide-body SOIC package with 8mm creepage and clearance and are rated up to 5kV<sub>RMS</sub>. This family of digital isolators offers low-power operation, high electromagnetic interference (EMI) immunity, and stable temperature performance through Analog Devices' proprietary process technology. The devices isolate different ground domains and block high-voltage/high-current transients from sensitive or human interface circuitry.

Devices are available with a maximum data rate of either 25Mbps (B/E versions) or 200Mbps (C/F versions). The MAX2224\_B/C feature default-high outputs. The MAX2224\_E/F feature default-low outputs. The default is the state the output assumes when the input is not powered or if the input is open circuit. The devices have two supply inputs (V<sub>DDA</sub> and V<sub>DDB</sub>) that independently set the logic levels on either side of the device. V<sub>DDA</sub> and V<sub>DDB</sub> are referenced to GNDA and GNDB, respectively. The MAX22245/MAX22246 family also features a refresh circuit to ensure output accuracy when an input remains in the same state indefinitely.

### Digital Isolation

The MAX22245/MAX22246 provide reinforced galvanic isolation for digital signals that are transmitted between two ground domains. The devices withstand differences of up to 5kV<sub>RMS</sub> for up to 60 seconds, and up to 1200V<sub>PEAK</sub> of continuous isolation.

### AEC-Q100 Qualification

Devices with /N suffix are AEC-Q100 qualified. Refer to the [Ordering Information](#) for all automotive grade part numbers.

### Level Shifting

The wide supply voltage range of both V<sub>DDA</sub> and V<sub>DDB</sub> allows the MAX22245/MAX22246 to be used for level translation in addition to isolation. V<sub>DDA</sub> and V<sub>DDB</sub> can be independently set to any voltage from 1.71V to 5.5V. The supply voltage sets the logic level on the corresponding side of the isolator.

### Unidirectional Channels

Each channel of the MAX22245/MAX22246 is unidirectional; it only passes data in one direction, as indicated in the [Functional Diagrams](#). Each device features two unidirectional channels that operate independently with guaranteed data rates from DC up to 25Mbps (B/E versions), or from DC to 200Mbps (C/F versions). The output driver of each channel is push-pull, eliminating the need for pullup resistors. The outputs are able to drive both TTL and CMOS logic inputs.

### Startup and Undervoltage Lockout

The V<sub>DDA</sub> and V<sub>DDB</sub> supplies are both internally monitored for undervoltage conditions. Undervoltage events can occur during power-up, power-down, or during normal operation due to a sagging supply voltage. When an undervoltage condition is detected on either supply, all outputs go to their default states regardless of the state of the inputs as seen in [Table 2](#). [Figure 2](#) through [Figure 5](#) show the behavior of the outputs during power-up and power-down.

**Table 2. Output Behavior During Undervoltage Condition**

V <sub>IN</sub>	V <sub>DDA</sub>	V <sub>DDB</sub>	V <sub>OUTA</sub>	V <sub>OUTB</sub>
1	Powered	Powered	High	High
0	Powered	Powered	Low	Low
X	Undervoltage	Powered	Default	Default
X	Powered	Undervoltage	Default	Default

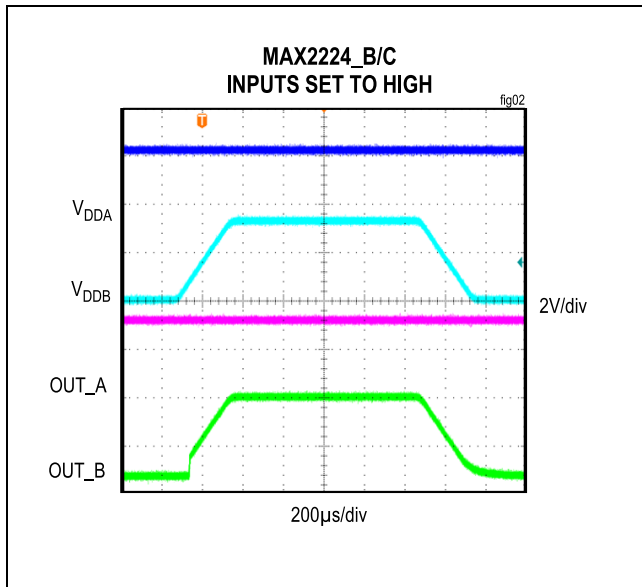

Figure 2. Undervoltage Lockout Behavior MAX2224\_B/C Input High

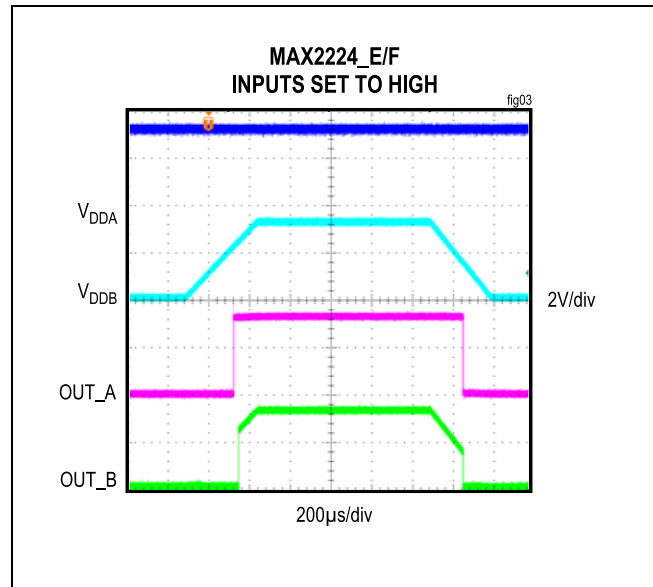

Figure 3. Undervoltage Lockout Behavior MAX2224\_E/F Input High

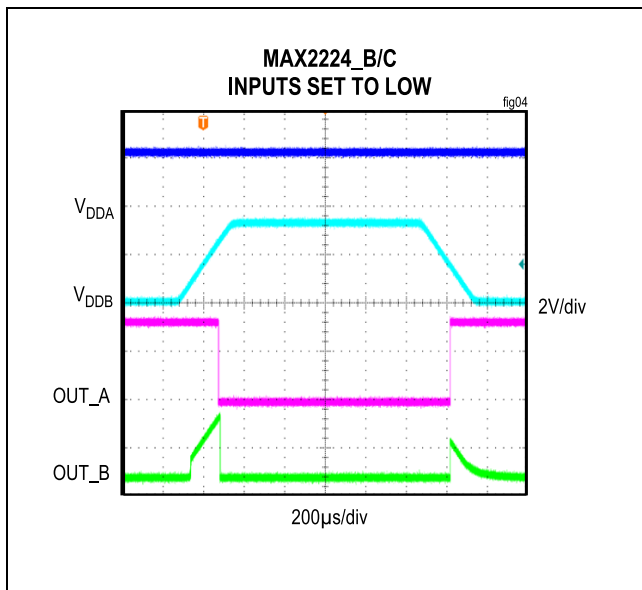

Figure 4. Undervoltage Lockout Behavior MAX2224\_B/C Input Low

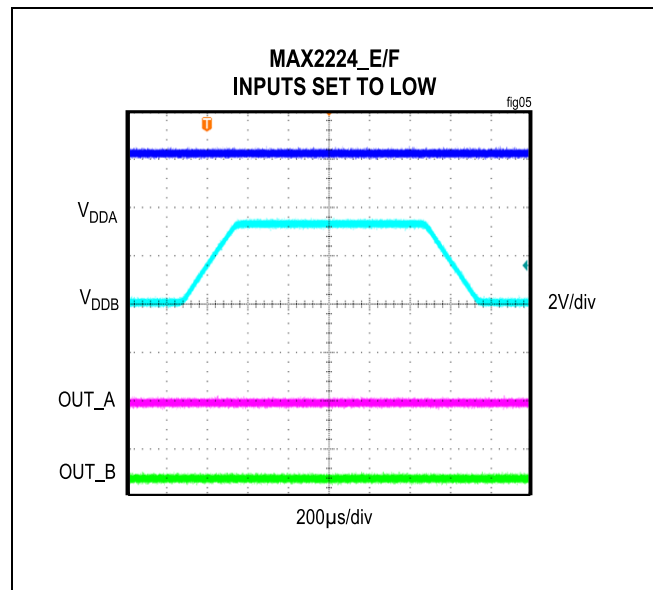

Figure 5. Undervoltage Lockout Behavior MAX2224\_E/F Input Low

### Safety Limits

Damage to the IC can result in a low-resistance path to ground or to the supply and, without current limiting, the MAX22245/MAX22246 can dissipate excessive amounts of power. Excessive power dissipation can damage the die and result in damage to the isolation barrier, potentially causing downstream issues. [Table 3](#) shows the safety limits for the MAX22245/MAX22246.

The maximum safety temperature ( $T_S$ ) for the device is the 150°C maximum junction temperature specified in the [Absolute Maximum Ratings](#). The power dissipation ( $P_D$ ) and junction-to-ambient thermal impedance ( $\theta_{JA}$ ) determine the junction temperature. Thermal impedance values ( $\theta_{JA}$  and  $\theta_{JC}$ ) are available in the [Package Information](#) section and

power dissipation calculations are discussed in the [Calculating Power Dissipation](#) section. Calculate the junction temperature ( $T_J$ ) as:

$$T_J = T_A + (P_D \times \theta_{JA})$$

[Figure 6](#) and [Figure 7](#) show the thermal derating curves for safety limiting the power and the current of the device. Ensure that the junction temperature does not exceed 150°C.

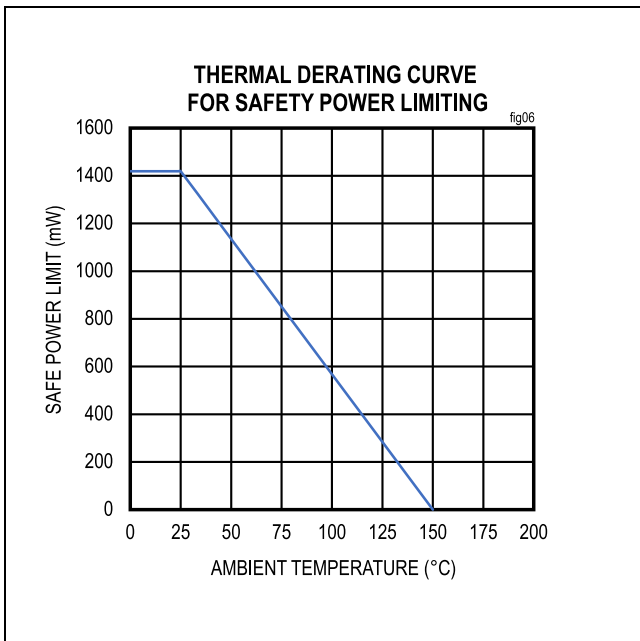

Figure 6. Thermal Derating Curve for Safety Power Limiting

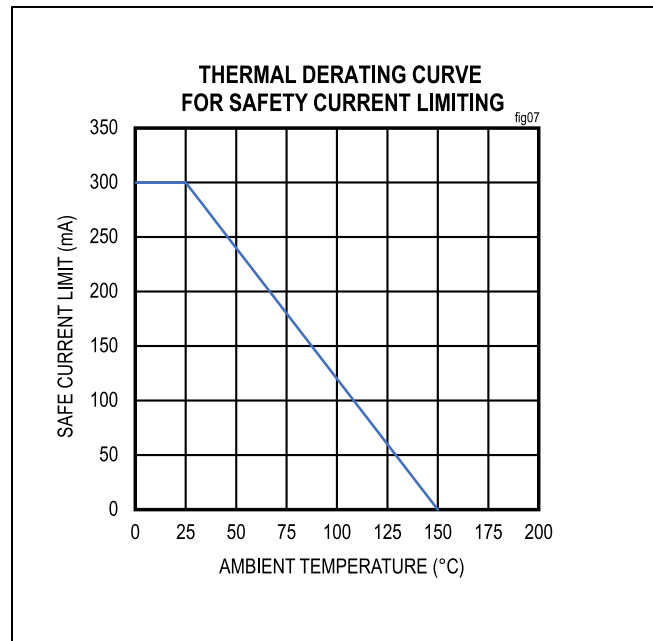

Figure 7. Thermal Derating Curve for Safety Current Limiting

**Table 3. Safety Limiting Values for the MAX22245/MAX22246**

PARAMETER	SYMBOL	TEST CONDITIONS	MAX	UNIT
Safety Current on Any Pin (No Damage to Isolation Barrier)	$I_S$	$T_J = 150^\circ\text{C}$ , $T_A = 25^\circ\text{C}$	300	mA
Total Safety Power Dissipation	$P_S$	$T_J = 150^\circ\text{C}$ , $T_A = 25^\circ\text{C}$	1418	mW
Maximum Safety Temperature	$T_S$		150	°C



## Applications Information

### Power-Supply Sequencing

The MAX22245/MAX22246 do not require special power-supply sequencing. The logic levels are set independently on either side by  $V_{DDA}$  and  $V_{ddb}$ . Each supply can be present over the entire specified range regardless of the level or presence of the other supply.

### Power-Supply Decoupling

To reduce ripple and the chance of introducing data errors, bypass  $V_{DDA}$  and  $V_{ddb}$  with 0.1 $\mu$ F low-ESR ceramic capacitors to GNDA and GNDB, respectively. Place the bypass capacitors as close to the power-supply input pins as possible.

### Layout Considerations

The PCB designer should follow some critical recommendations in order to get the best performance from the design.

- Keep the input/output traces as short as possible. To keep signal paths low inductance, avoid using vias.
- Have a solid ground plane underneath the high-speed signal layer.
- Keep the area underneath the MAX22245/MAX22246 free from ground and signal planes. Any galvanic or metallic connection between the Side A and Side B defeats the isolation.

### Calculating Power Dissipation

The required current for a given supply ( $V_{DDA}$  or  $V_{ddb}$ ) can be estimated by summing the current required for each channel. The supply current for a channel depends on whether the channel is an input or an output, the channel's data rate, and the capacitive or resistive load if it is an output. The typical current for an input or output at any data rate can be estimated from the graphs in [Figure 8](#) and [Figure 9](#). Note that the data in [Figure 8](#) and [Figure 9](#) are extrapolated from the supply current measurements in a typical operating condition.

The total current for a single channel is the sum of the no load current (shown in [Figure 8](#) and [Figure 9](#)), which is a function of voltage and data rate, and the load current, which depends on the type of load. Current into a capacitive load is a function of the load capacitance, the switching frequency, and the supply voltage.

$$I_{CL} = C_L \times f_{SW} \times V_{DD}$$

where:

$I_{CL}$  is the current required to drive the capacitive load.

$C_L$  is the load capacitance on the isolator's output pin.

$f_{SW}$  is the switching frequency (bits per second/2).

$V_{DD}$  is the supply voltage on the output side of the isolator.

Current into a resistive load depends on the load resistance, the supply voltage and the average duty cycle of the data waveform. The DC load current can be conservatively estimated by assuming the output is always high.

$$I_{RL} = V_{DD} \div R_L$$

where:

$I_{RL}$  is the current required to drive the resistive load.

$V_{DD}$  is the supply voltage on the output side of the isolator.

$R_L$  is the load resistance on the isolator's output pin.

**Example** (shown in [Figure 10](#)): A MAX22246C/F is operating with  $V_{DDA} = 2.5V$ ,  $V_{ddb} = 3.3V$ , channel 1 operating at 100Mbps with a 15pF capacitive load, and channel 2 operating at 20Mbps and 50% duty cycle with a 10k $\Omega$  resistive load. See [Table 4](#) and [Table 5](#) for  $V_{DDA}$  and  $V_{ddb}$  supply-current calculation worksheets.

### $V_{DDA}$ must supply:

- Channel 1 is an output channel operating at 2.5V and 100Mbps, consuming 0.84mA, estimated from [Figure 9](#).
- Channel 2 is an input channel operating at 2.5V and 20Mbps, consuming 0.35mA, estimated from [Figure 8](#).
- $I_{CL}$  on Channel 1 for 15pF capacitor at 2.5V and 100Mbps is 1.875mA.

Total current for side A = 0.84mA + 0.35mA + 1.875mA = 3.065mA (typ)

**V<sub>DDB</sub> must supply:**

Channel 1 is an input channel operating at 3.3V and 100Mbps, consuming 1.16mA, estimated from [Figure 8](#).

- Channel 2 is an output channel operating at 3.3V and 20Mbps, consuming 0.41mA, estimated from [Figure 9](#).
- I<sub>RL</sub> on Channel 2 for 10kΩ resistor switching at 50% duty cycle and at 3.3V is 0.165mA.

Total current for side B = 1.16mA + 0.41mA + 0.165mA = 1.735mA (typ)

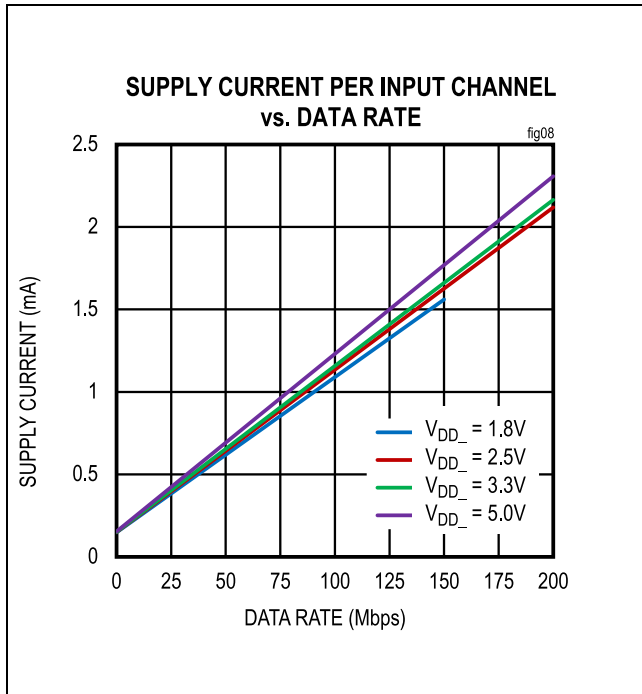

Figure 8. Supply Current per Input Channel (Estimated)

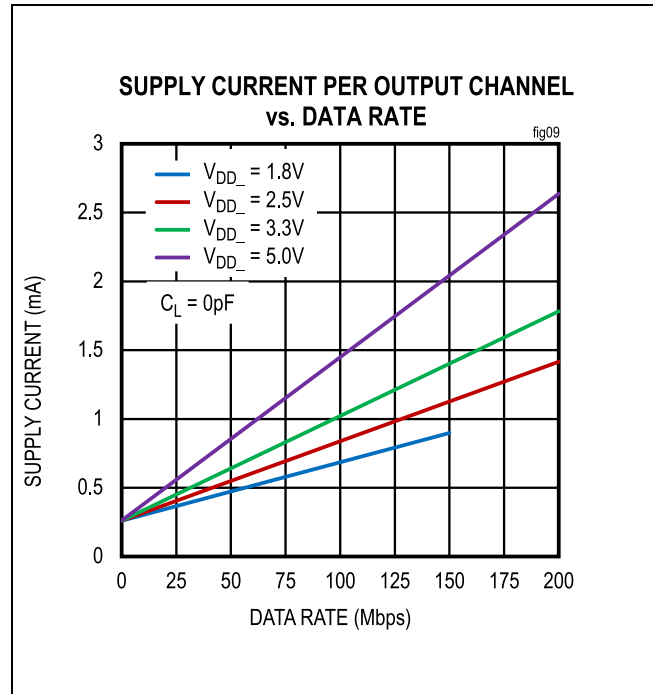

Figure 9. Supply Current per Output Channel (Estimated)

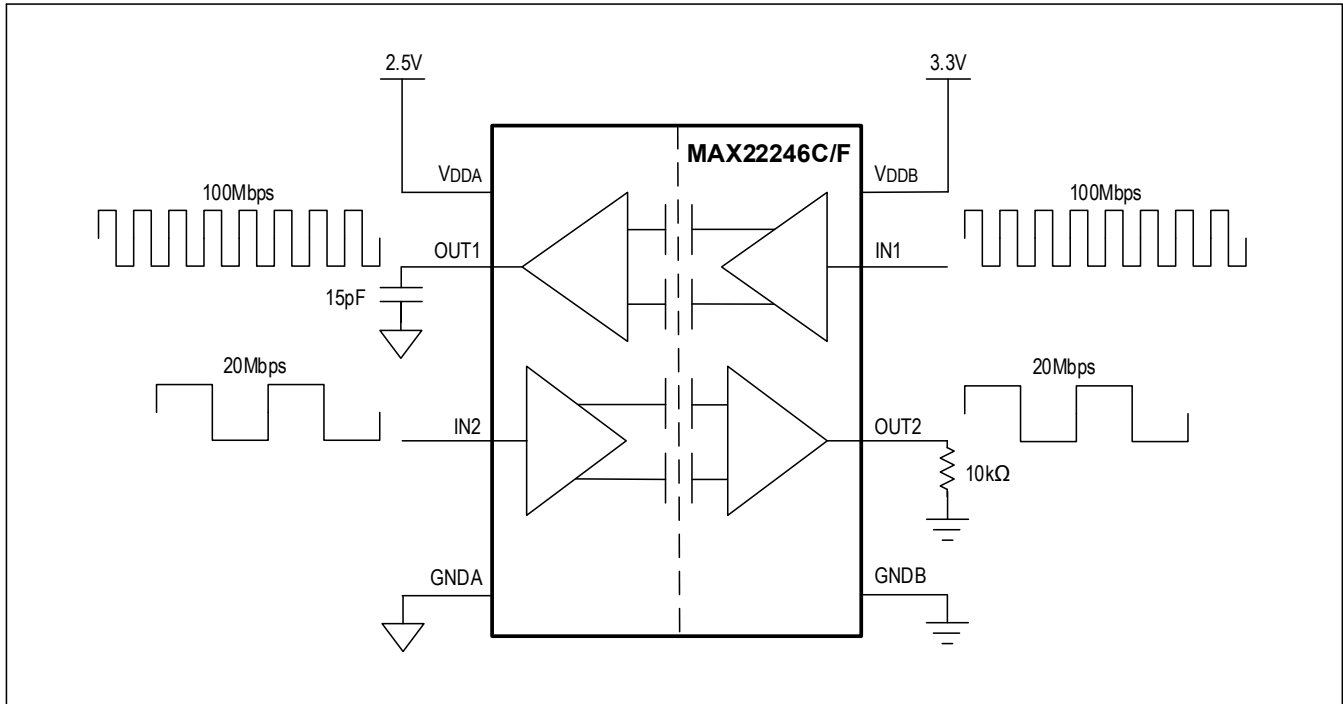

Figure 10. Example Circuit for Supply Current Calculation

**Table 4. Side A Supply Current Calculation Worksheet**

SIDE A		V <sub>DDA</sub> = 2.5V				
CHANNEL	IN/OUT	DATA RATE (Mbps)	LOAD TYPE	LOAD	NO LOAD CURRENT (mA)	LOAD CURRENT (mA)
1	OUT	100	Capacitive	15pF	0.84	2.5V x 50MHz x 15pF = 1.875mA
2	IN	20			0.35	
Total: 3.065mA						

**Table 5. Side B Supply Current Calculation Worksheet**

SIDE B		V <sub>DDB</sub> = 3.3V				
CHANNEL	IN/OUT	DATA RATE (Mbps)	LOAD TYPE	LOAD	NO LOAD CURRENT (mA)	LOAD CURRENT (mA)
1	IN	100			1.16	
2	OUT	20	Resistive	10kΩ	0.41	3.3V / 10kΩ x 0.5 = 0.165mA
Total: 1.735mA						

Typical Application Circuits

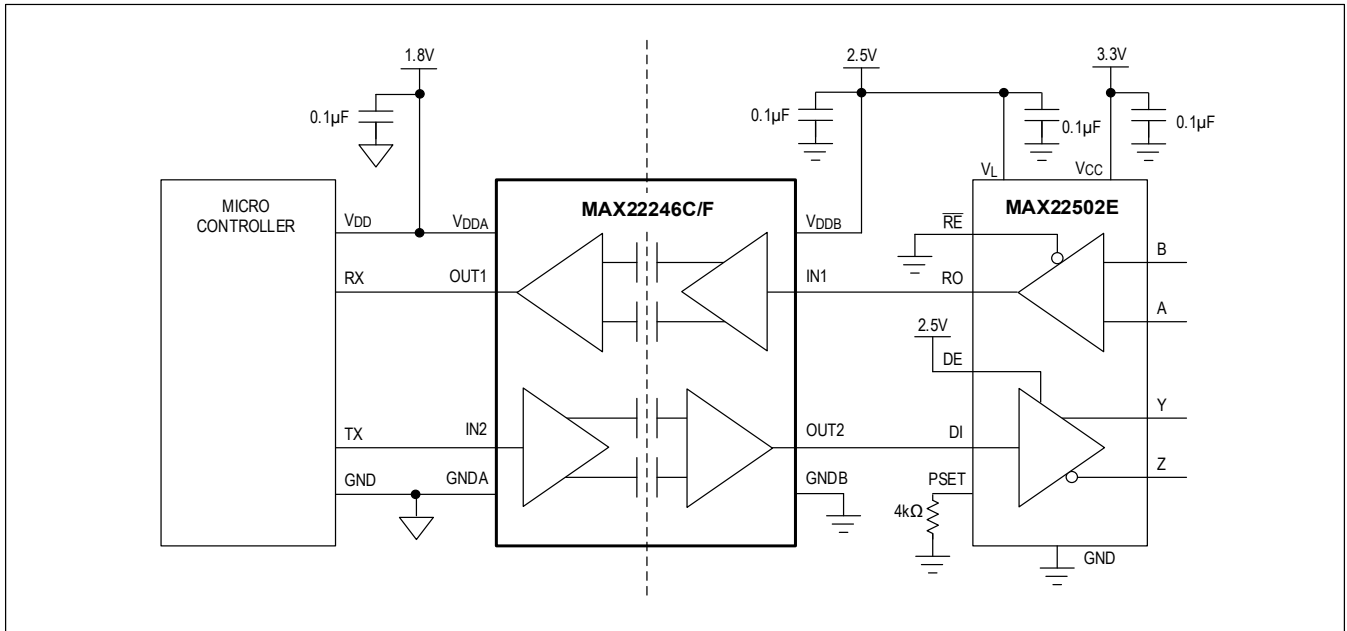

Product Selector Guide

DEVICE CONFIGURATION	MAX DATA RATE	
	25Mbps	200Mbps
DEFAULT-HIGH OUTPUT	B	C
DEFAULT-LOW OUTPUT	E	F

## Ordering Information

PART NUMBER	CHANNEL CONFIGURATION	DATA RATE (Mbps)	DEFAULT OUTPUT	ISOLATION VOLTAGE (kV <sub>RMS</sub> )	TEMPERATURE RANGE (°C)	PIN-PACKAGE
<b>GENERAL PURPOSE DEVICES</b>						
MAX22245BAWA+	2/0	25	High	5	-40 to +125	8 Wide SOIC
MAX22245CAWA+*	2/0	200	High	5	-40 to +125	8 Wide SOIC
MAX22245EAWA+*	2/0	25	Low	5	-40 to +125	8 Wide SOIC
MAX22245FAWA+	2/0	200	Low	5	-40 to +125	8 Wide SOIC
MAX22246BAWA+*	1/1	25	High	5	-40 to +125	8 Wide SOIC
MAX22246CAWA+	1/1	200	High	5	-40 to +125	8 Wide SOIC
MAX22246EAWA+*	1/1	25	Low	5	-40 to +125	8 Wide SOIC
MAX22246FAWA+	1/1	200	Low	5	-40 to +125	8 Wide SOIC
<b>AUTOMOTIVE DEVICES</b>						
MAX22245BAWA/V+*	2/0	25	High	5	-40 to +125	8 Wide SOIC
MAX22245CAWA/V+*	2/0	200	High	5	-40 to +125	8 Wide SOIC
MAX22245EAWA/V+*	2/0	25	Low	5	-40 to +125	8 Wide SOIC
MAX22245FAWA/V+	2/0	200	Low	5	-40 to +125	8 Wide SOIC
MAX22246BAWA/V+*	1/1	25	High	5	-40 to +125	8 Wide SOIC
MAX22246CAWA/V+	1/1	200	High	5	-40 to +125	8 Wide SOIC
MAX22246EAWA/V+*	1/1	25	Low	5	-40 to +125	8 Wide SOIC
MAX22246FAWA/V+*	1/1	200	Low	5	-40 to +125	8 Wide SOIC

\*Future product—contact Analog Devices for availability.

+Denotes a lead(Pb)-free/RoHS-compliant package.

/V Denotes an automotive qualified part.

## Chip Information

PROCESS: BiCMOS