

MAX25605 Evaluation Kit

Evaluates: MAX25605

General Description

The MAX25605 evaluation kit (EV kit) provides a proven design to evaluate the MAX25605 6-switch sequential LED controller for automotive lighting systems. The MAX25605 EV kit demonstrates a complete sequential lighting design, including an on-board timing circuit, two MAX25611 LED drivers configured as boost-to-battery (battery referenced buck-boost), and two MAX25605 sequential LED controllers. Additionally, the EV kit has 12 yellow LEDs installed and comes with an acrylic shield to cover the LEDs for eye protection. The board includes mechanical switches to easily demonstrate different sequence settings and modes of operation. Refer to the MAX25611 and the MAX25605 data sheets for detailed information regarding these ICs.

Benefits and Features

- LED Driver, Timing Circuit, Sequencer, LEDs, and LED Cover
- Demonstrates Dim Up and Dim Down Sequence
- Sequence Timing Adjustment Potentiometer
- Toggle Switches to Easily Evaluate Different Modes of Operation
- Hazard Light Mode
- No Software or Graphical User Interface (GUI) Required

[Ordering Information](#) appears at end of data sheet.

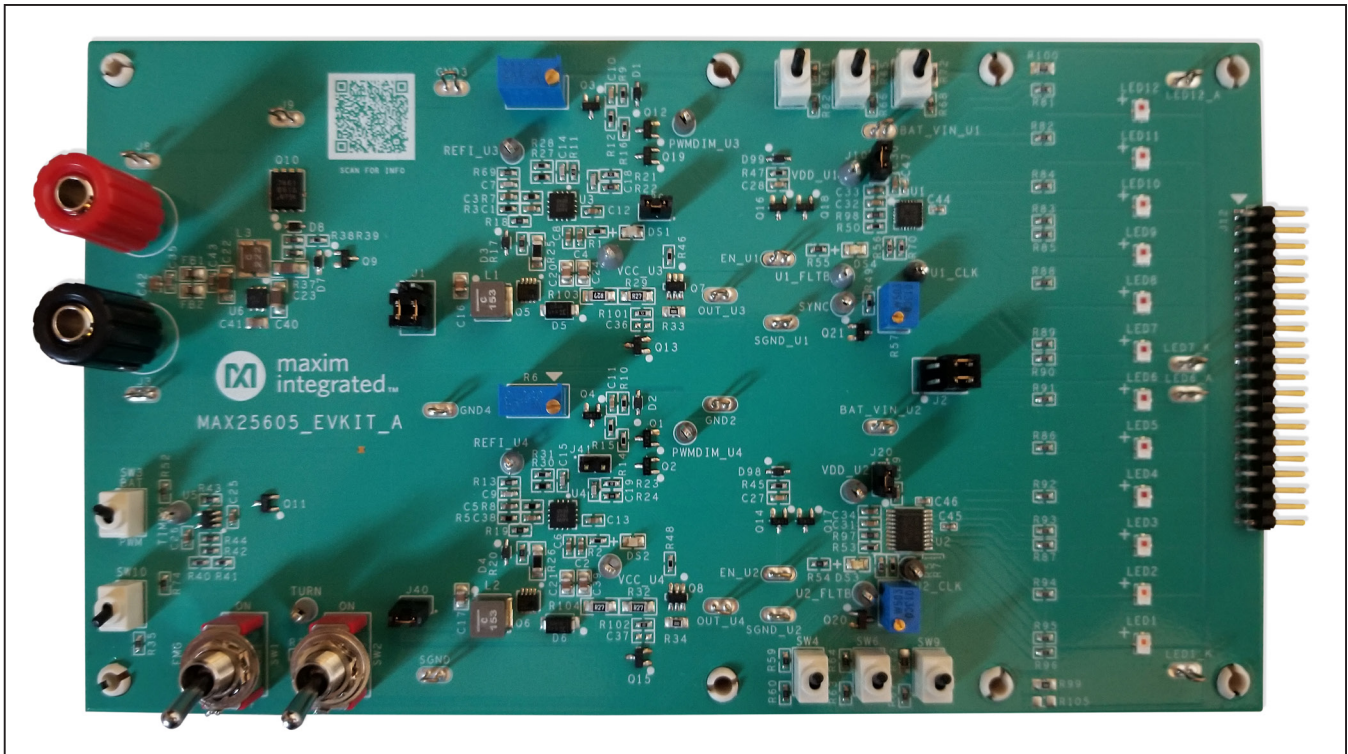

Figure 1. MAX25605EVKIT#

Quick Start

Required Equipment

- MAX25605 EV kit
- Acrylic LED cover (included)
- 12V, 3A DC power supply

Procedure

The EV kit is fully assembled and tested. Follow the steps below to verify board operation. **Caution: Do not turn on the power supply until all connections are made. Additional caution should be taken; the on-board LEDs are very bright when illuminated.**

- 1) Verify that all jumpers and switches are in their default positions, as shown in [Figure 1](#).
- 2) Verify that the acrylic shield is covering the LEDs.
- 3) Connect the positive terminal of the 12V supply to the J8 PCB pad or the red banana plug TP1 receptacle.

- 4) Connect the negative or ground terminal of the 12V supply to the J3 PCB pad or the black banana plug TP2 receptacle.
- 5) Turn on the DC power supply.
- 6) Toggle the S2 switch to the ON position.
- 7) Verify that the LEDs sequence on and off.

Detailed Description

The MAX25605 EV kit provides a proven design to evaluate the MAX25605 LED sequencer. The EV kit is set up for buck-boost (boost-to-battery) configuration and operates from a 6V–18V DC supply voltage. The EV kit is configured to deliver up to 700mA to a series LED string. The EV kit includes 12 yellow LEDs from the SYNIOS P2720 family from OSRAM®-Opto Semiconductors, rated for up to 1A of current. See [Figure 2](#) for a block diagram of the evaluation board.

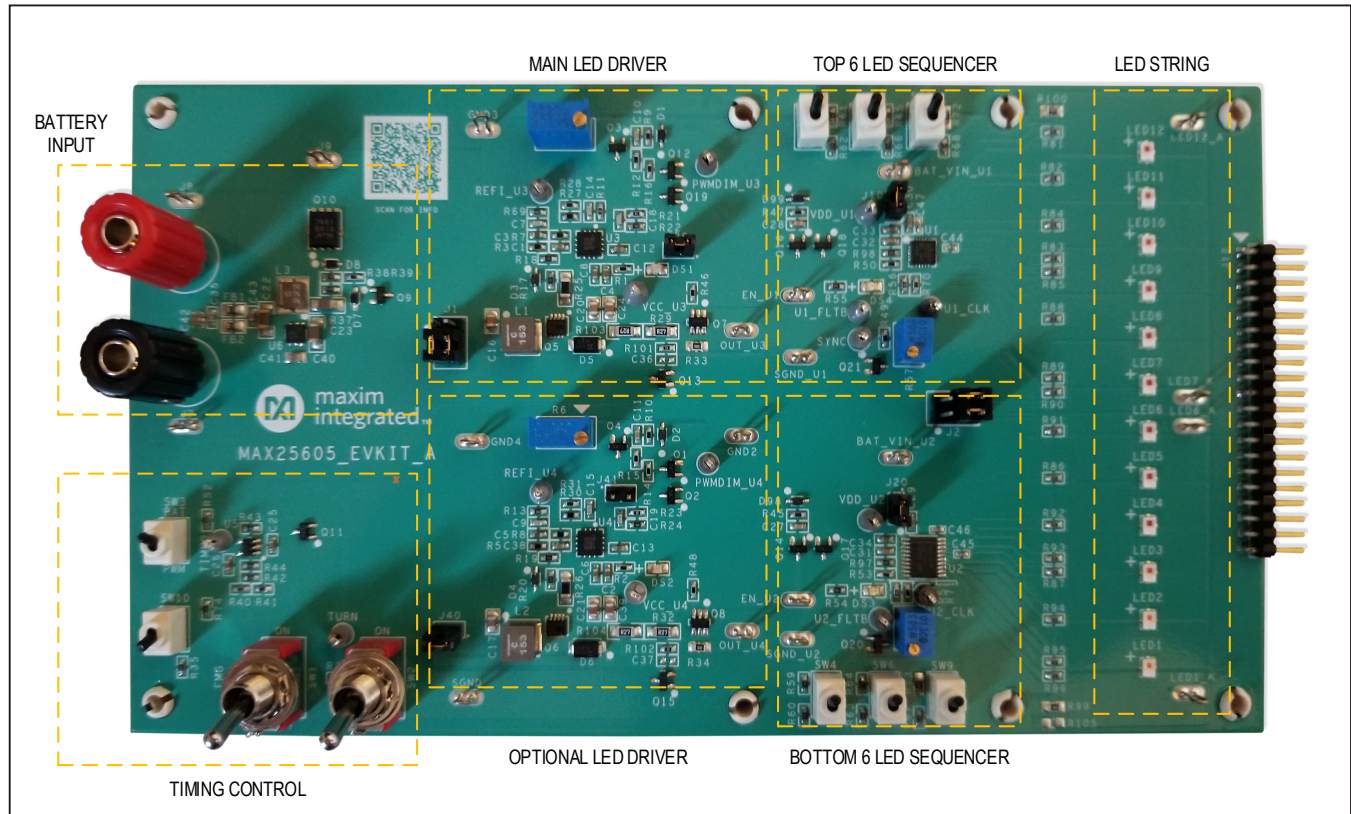

Figure 2. EV Kit Block Diagram

OSRAM is a registered trademark of Osram GmbH.

Timing Circuit

A relaxation oscillator circuit is implemented on the EV kit to generate the 1.25Hz signal for demonstrating a turn signal. The SW2 enables or disables the oscillator circuit and is the main control to enable or disable the LED driver and LED sequencers.

Control Options

There are two different control methods demonstrated on the board:

- 1) The timing circuit can drive the PWM input of the LED driver and the EN input of the sequencers.
- 2) The timing circuit can drive a battery switch which controls power for the entire board.

The turn signal control method is set based on the position of SW3. Either method is an acceptable way to implement a turn signal system using the MAX25605 LED sequencer.

LED Drivers

There are two MAX25611 buck-boost (boost-to-battery) LED drivers installed on the EV kit. By default, the EV kit is configured to drive all 12 LEDs in a single string

configuration with the U3 LED driver. The board can be configured to drive the 12 LEDs as two separate strings of 6 series LEDs. In this configuration, U3 drives the top 6 LEDs and U4 drives the bottom 6 LEDs. The LED current can be adjusted by the potentiometers R4 and R6 which control U3 and U4, respectively.

Sequencer Programming

The MAX25605 sequencer devices are configured through resistor settings. The EV kit includes SW4–SW9 to easily change between different resistor options which demonstrate some of the features of the device. See [Table 2](#) for a detailed description of each switch position. The switches change the resistor values on the A0, A1, and A2 pins of the MAX25605. These inputs are sampled during power up (V_{IN} rising above the UVLO threshold). Potentiometers R57 and R58 adjust the resistance on the CLK input which controls the sequence individual step time (T_{SEQ}) between approximately 2ms and 55ms. The CLK input is the only resistor programming option that is continuously active during normal operation, as opposed to the A0, A1, and A2 programming inputs which are sampled only during the IN power up.

Table 1. Default Shunt Positions and Jumper Description

JUMPER	SHUNT POSITION	DESCRIPTION
J1	1–3 and 2–4	V_{BAT} connected to optional second LED driver (U4).
	3–5 and 4–6*	Optional second LED driver, U4, not used.
	Open	Optional second LED driver, U4, not used.
J2	1–3 and 2–4	Two strings of 6 series LEDs. LEDs 1 through 6 are driven by U4 and LEDs 7 through 12 are driven by U3. The second LED driver, U4, should be connected to V_{BAT} when this setting is used.
	3–5 and 4–6*	One string of 12 series LEDs driven by the primary LED driver, U3.
J10	1–2*	Input power supplied to U1, the MAX25605 sequencer controlling LEDs 7 through 12.
J20	1–2*	Input power supplied to U2, the MAX25605 sequencer controlling LEDs 1 through 6.
J30	1–2*	Input power supplied to U3, MAX25611 LED driver.
J40	1–2*	Input power supplied to U4, optional second MAX25611 LED driver.
J41	1–2	PWMDIM of U4 MAX25611 LED driver connected to EN net of the sequencers.
	Open*	PWMDIM of U4 MAX25611 LED driver not connected to EN net of the sequencers.

*Default position.

Table 2. Switch Settings

SWITCH	SWITCH POSITION	DESCRIPTION
S1	OFF*	Hazard light mode is disabled. The MAX25605 devices sequence the LEDs when enabled.
	ON	Hazard light mode is enabled. The MAX25605 devices do not shunt any current from the LED string, resulting in the entire LED string being ON or OFF depending only on the LED driver.
S2	OFF*	The on-board 1.25Hz oscillator circuit is disabled. If SW3 is in the BAT position, the LEDs are statically off. If SW3 is in the PWM position, the LEDs are statically on after sequencing once.
	ON	The on board 1.25Hz oscillator circuit is enabled. The LEDs continuously cycle on and off.
SW3	PWM	The 1.25Hz timing circuit output is connected to PWM of LED driver and EN of sequencer. Battery power to the board is fixed and the sequencing is done by toggling the PWM and EN inputs. The SW4 through SW9 sequencer configuration resistors are sampled only once, either at power up or at the moment SW3 is toggled from BAT to PWM.
	BAT*	The 1.25Hz timing circuit output is connected to battery switch, toggling the battery line for the board which causes the sequence to reset and start again on each new pulse. The SW4 through SW9 sequencer configuration resistors are resampled on each 1.25Hz cycle.
SW4	DOWN	U2 configured to DIM DOWN, with all LEDs starting out on, then LED6 turning off, followed by LED5 and continuing down to LED1.
	UP*	U2 configured to DIM UP, with all LEDs starting out off, then LED1 turning on, followed by LED2 and continuing up to LED6.
SW5	DOWN	U1 configured to DIM DOWN, with all LEDs starting out on, then LED12 turning off, followed by LED11 and continuing down to LED7.
	UP*	U1 configured to DIM UP, with all LEDs starting out off, then LED7 turning on, followed by LED8 and continuing up to LED12.
SW6	DOWN	U2 configured to wait for 1 SYNC pulse before starting to sequence. If SW7 is in the DOWN position, U1 starts the sequence and sends a SYNC pulse to U2 to continue the sequence.
	UP*	U2 configured to wait for 0 SYNC pulses before starting to sequence. This means U2 begins the sequence at the rising edge of the EN signal.
SW7	DOWN	U1 configured to wait for 0 SYNC pulses before starting to sequence. This means U1 begins the sequence at the rising edge of the EN signal.
	UP*	U1 configured to wait for 1 SYNC pulse before starting to sequence. If SW6 is in the UP position, U2 starts the sequence and sends a SYNC pulse to U1 to continue the sequence.
SW8	DOWN	U1 LED fading enabled.
	UP*	U1 LED fading disabled.
SW9	DOWN	U2 LED fading enabled.
	UP*	U2 LED fading disabled.
SW10	DOWN*	Hazard light option 1 method enabled. Hazard light is achieved by pulling the EN input of the sequencers low.
	UP	Hazard light option 2 method is enabled. Hazard light is achieved by reducing the RCLK value of the MAX25605 sequencer. This option only works when the sequencers are configured to DIM UP (SW4 and SW5 in UP position).

*Default position.

Dim Up and Dim Down

The MAX25605 EV kit is configured by default to “dim up”, meaning the LEDs are off at the beginning of the sequence, then turn on one-by-one until all 12 LEDs are on at the end of the sequence. To demonstrate a “dim down” sequence, toggle SW4–SW7 from the default up position to the down position. The “dim down” sequence starts with all 12 LEDs turning on, then each LED turns off one-by-one until all 12 LEDs are off at the end of the sequence.

Hazard Light Mode

The MAX25605 LED sequence can be bypassed, to allow the LEDs to all turn on and turn off at the same time. SW1 demonstrates this feature. When both SW1 and SW2 are in the ON position, the LEDs alternate on and off at the 1.25Hz rate, but without the single-LED sequence. All 12 LEDs turn on and turn off at the same time.

LED Fade

The MAX25605 has an optional logarithmic fade function. Rather than an LED stepping from 0% to 100% on each sequence step, the LED is PWM-switched on and off with a gradual change in PWM duty cycle, resulting in a smoother appearing transition of each LED in the sequence. The MAX25605 accommodates fade duration settings of 1, 2, or 3 t_{SEQ} periods. The EV kit includes SW8 and SW9 which toggle the A2 resistor value of the MAX25605 devices to either disable fade or enable it with a duration of 2 t_{SEQ} periods. The fade feature is typically used in applications with a smaller number of LEDs, where each sequence step becomes more noticeable.

Acrylic Shield

The MAX25605 EV kit comes with 12 yellow LEDs installed that are very bright, especially at the maximum current setting. It is recommended to use the included acrylic shield to cover the LEDs during operation.

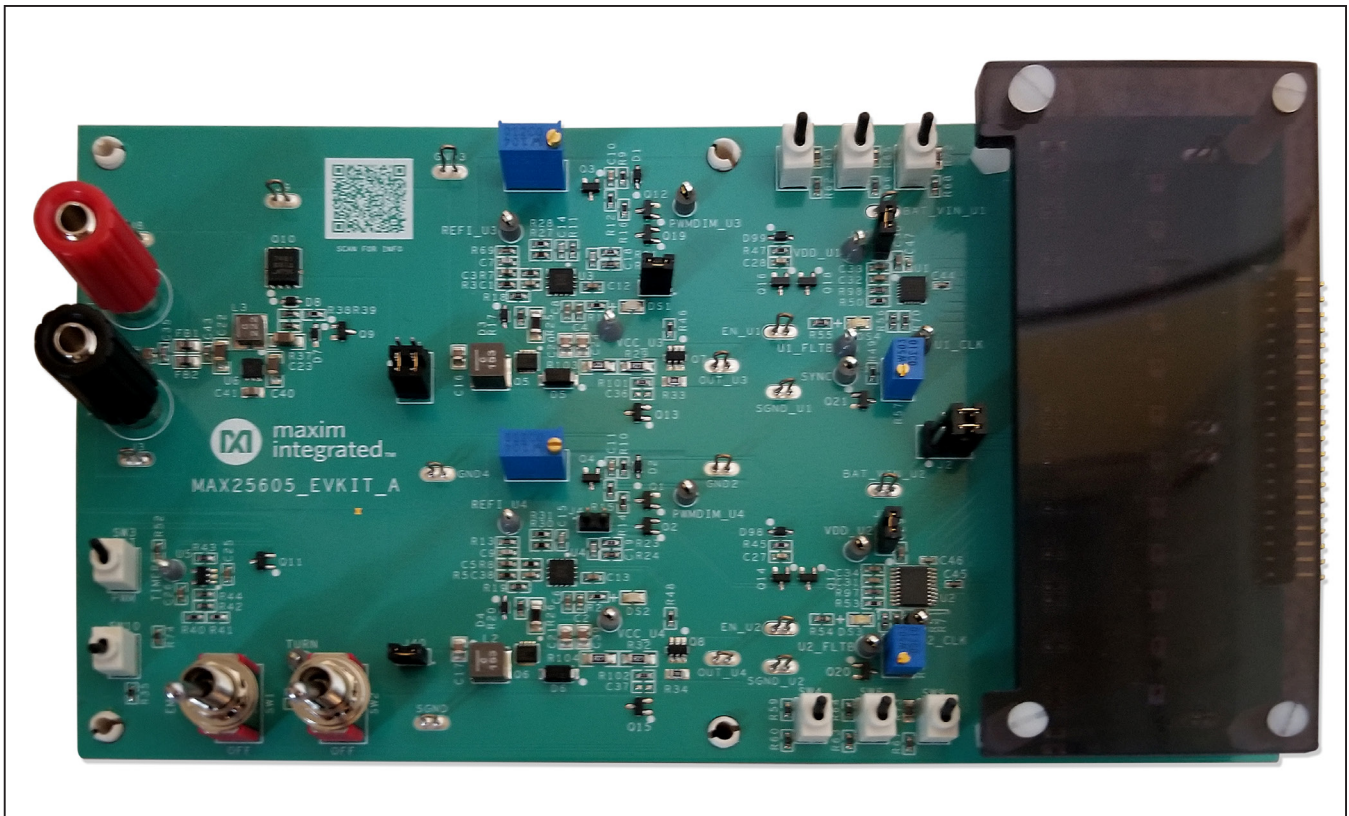

Figure 3. MAX25605EVKIT# with Acrylic Shield Installed

Ordering Information

PART	TYPE
MAX25605EVKIT#	EV Kit

#Denotes RoHS compliant.

MAX25605 EV Kit Bill of Materials

REF_DES	QTY	MFG PART #	MANUFACTURER	VALUE	DESCRIPTION
BAT_VIN_U1, BAT_VIN_U2, EN_U1, EN_U2, GND2-GND4, J3, J8, J9, LED1_K, LED6_A, LED7_K, LED12_A, OUT_U3, OUT_U4, SGND, SGND_U1, SGND_U2	19	9020 BUSS	WEICO WIRE	MAXIMPAD	EVK KIT PARTS; MAXIM PAD; WIRE; NATURAL; SOLID; WEICO WIRE; SOFT DRAWN BUS TYPE-S; 20AWG
C1, C38	2	C0603C103K2RAC	KEMET	0.01 μ F	CAPACITOR; SMT (0603); CERAMIC CHIP; 0.01 μ F; 200V; TOL = 10%; MODEL = ; TG = -55°C TO +125°C; TC = X7R
C2, C4	2	C0603C475K8PAC; LMK107BJ475KA; CGB3B1X5R1A475K; C1608X5R1A475K080AC; CL10A475KP8NNN	KEMET; TAIYO YUDEN; TDK; TDK; SAMSUNG ELECTRONICS	4.7 μ F	CAPACITOR; SMT (0603); CERAMIC CHIP; 4.7 μ F; 10V; TOL = 10%; TG = -55°C TO +85°C; TC = X5R
C3, C5	2	C0603C105K4RAC; GRM188R71C105KA12; C1608X7R1C105K080AC; EMK107B7105KA; CGA3E1X7R1C105K080AC; 0603YC105KAT2A	KEMET; MURATA; TDK; TAIYO YUDEN; TDK; AVX	1 μ F	CAPACITOR; SMT (0603); CERAMIC CHIP; 1 μ F; 16V; TOL = 10%; MODEL = ; TG = -55°C TO +125°C; TC = X7R
C6, C8, C26, C29, C30	5	CC0603KRX7R0BB104; GRM188R72A104KA35; HMK107B7104KA; 06031C104KAT2A; GRM188R72A104K	YAGEO; MURATA; TAIYO YUDEN; AVX; MURATA	0.1 μ F	CAPACITOR; SMT (0603); CERAMIC CHIP; 0.1 μ F; 100V; TOL = 10%; TG = -55°C TO +125°C; TC = X7R
C7, C9, C14, C15, C18, C19	6	GRM1885C1H102JA01; C1608C0G1H102J080AA; GCM1885C1H102JA16	MURATA; TDK; MURATA	1000PF	CAPACITOR; SMT (0603); CERAMIC CHIP; 1000PF; 50V; TOL = 5%; TG = -55°C TO +125°C
C16, C17, C20, C21, C24, C39	6	C2012X7R1H225K125AC	TDK	2.2 μ F	CAPACITOR; SMT (0805); CERAMIC CHIP; 2.2 μ F; 50V; TOL = 10%; TG = -55°C TO +125°C; TC = X7R
C22, C23, C40	3	GRM31CR71H475KA12; GRJ31CR71H475KE11; GXM31CR71H475KA10; UMK316AB7475KL	MURATA; MURATA; MURATA; TAIYO YUDEN	4.7 μ F	CAPACITOR; SMT (1206); CERAMIC CHIP; 4.7 μ F; 50V; TOL = 10%; MODEL = ; TG = -55°C TO +125°C; TC = X7R

MAX25605 EV Kit Bill of Materials (continued)

REF_DES	QTY	MFG PART #	MANUFACTURER	VALUE	DESCRIPTION
C25, C31, C32	3	C1608X5R1E225K; TMK107ABJ225KA; TMK107BJ225KA; GRM188R61E225KA12	TDK; TAIYO YUDEN; TAIYO YUDEN; MURATA	2.2µF	CAPACITOR; SMT (0603); CERAMIC CHIP; 2.2µF; 25V; TOL = 10%; MODEL = ; TG = -55°C TO +85°C; TC = X5R
C35, C43	2	C0603C102K1GAC; C1608C0G2A102K080AA	KEMET; TDK	1000PF	CAPACITOR; SMT (0603); CERAMIC CHIP; 1000PF; 100V; TOL = 10%; MODEL = C0G; TG = -55°C TO +125°C; TC =
C41	1	GRM21BR61A106KE19; ECJ-2FB1A106; CL21A106KPCLQNC; GRM219R61A106KE44	MURATA; PANASONIC; SAMSUNG ELECTRONICS; MURATA	10µF	CAPACITOR; SMT (0805); CERAMIC CHIP; 10UF; 10V; TOL = 10%; MODEL = ; TG = -55°C TO +85°C; TC = X5R
C42	1	NFM21HC223R1H3	MURATA	0.022µF	CAP; SMT (0805); 0.022UF; 20%; 50V; CERAMIC CHIP
C44-C47	4	C0402C103K5RAC; GRM155R71H103KA88; C1005X7R1H103K050BE; CL05B103KB5NNN; UMK105B7103KV	KEMET; MURATA; TDK; SAMSUNG ELECTRONIC; TAIYO YUDEN	0.01µF	CAPACITOR; SMT (0402); CERAMIC CHIP; 0.01µF; 50V; TOL = 10%; TG = -55°C TO +125°C; TC = X7R
D1-D4, D98, D99	6	1N4148WS-7-F	DIODES INCORPORATED	1N4148WS-7-F	DIODE; SWT; SMT (SOD-323); PIV = 75V; IF = 0.3A
D5, D6	2	B160-13-F	DIODES INCORPORATED	B160-13-F	DIODE; SCH; SMA; PIV = 60V; IF = 1A
D7	1	BZX384B5V1-E3-08	VISHAY SEMICONDUCTORS	5.1V	DIODE; ZNR; SMT (SOD-323); Vz = 5.1V; Izm = 0.002A
D8	1	TDZ15J	NEXPERIA	15V	DIODE; ZNR; SMT (SOD-323F); VZ = 15V; IZ = 0.005A
DS1, DS2	2	SML-LXT0805GW	LUMEX OPTO COMPONENTS INC.	SML-LXT0805GW-TR	DIODE; LIGHT EMITTING GREEN; SMT (0805); IF(PEAK) = 0.15A; I(STEADY) = 0.025A; PD = 0.105W; VF = 2.0V
DS3, DS4	2	APT2012SURCK	KINGBRIGHT	APT2012SURCK	DIODE; LED; SMD CHIP LED LAMP; RED; SMT; PIV = 1.95V; IF = 0.02A
EMG, PWMDIM_U3, PWMDIM_U4, REFL_U3, REFL_U4, SYNC, TIMER, TURN, U1_CLK, U1_FLTB, U2_CLK, U2_FLTB, VCC_U3, VCC_U4, VDD_U1, VDD_U2	16	5123	KEYSTONE	N/A	TEST POINT; PIN DIA = 0.125IN; TOTAL LENGTH = 0.35IN; BOARD HOLE = 0.063IN; GRAY; PHOSPHOR BRONZE WIRE SILVER PLATE FINISH;

MAX25605 EV Kit Bill of Materials (continued)

REF_DES	QTY	MFG PART #	MANUFACTURER	VALUE	DESCRIPTION
FB1, FB2	2	BLM21PG220SN1	MURATA	22	INDUCTOR; SMT (0805); FERRITE-BEAD; 22; TOL = ±25%; 6A; -55°C TO +125°C
J1, J2	2	PEC03DAAN	SULLINS ELECTRONICS CORP.	PEC03DAAN	CONNECTOR; MALE; THROUGH HOLE; BREAKAWAY; STRAIGHT THROUGH; 6PINS; -65°C TO +125°C
J10, J20, J30, J40, J41	5	PCC02SAAN	SULLINS	PCC02SAAN	CONNECTOR; MALE; THROUGH HOLE; BREAKAWAY; STRAIGHT THROUGH; 2 PINS; -65°C TO +125°C
J12	1	PBC20SBAN	SULLINS CONNECTOR	PBC20SBAN	CONNECTOR; MALE; THROUGH HOLE; BREAKAWAY HEADERS; RIGHT ANGLE; 20 PINS;
JU1, JU2	2	MNT-102-BK-G	SAMTEC	MNT-102-BK-G	CONNECTOR; FEMALE; 0.100IN MULTI POSITION SHUNT; OPEN TOP; JUMPER; STRAIGHT; 4PINS
JU10, JU20, JU30, JU40	4	SNT-100-BK-G	SAMTEC	SNT-100-BK-G	TEST POINT; SHUNT AND JUMPER; STR; TOTAL LENGTH = 6.10MM; BLACK; INSULATION = GLASS FILLED POLYESTER; CONTACT = PHOSPHOR BRONZE
L1, L2	2	XAL5050-153ME	COILCRAFT	15µH	INDUCTOR; SMT; COMPOSITE; 15µH; 20%; 3.9A
L3	1	XAL4020-222ME	COILCRAFT	2.2µH	INDUCTOR; SMT; COMPOSITE CORE; 2.2µH; TOL = ±20%; 4A
LED1-LED12	12	KY DMLS31.23-8J7L-46-M3W3	OSRAM	KY DMLS31.23-8J7L-46-M3W3	DIODE; LED; YELLOW; SMT; VF = 2.55V; IF = 0.7A
MECH1-MECH4	4	1902B	GENERIC PART	1902B	STANDOFF; FEMALE-THREADED; HEX; 4-40IN; 3/8IN; NYLON
Q1-Q4, Q9, Q12, Q14, Q16-Q21	13	2N7002; 2N7002; 2N7002; 2N7002	DIODES INCORPORATED; ST MICRO ELECTRONICS; ON SEMICONDUCTOR; MICRO COMMERCIAL COMPONENTS	2N7002	TRAN; ; NCH; SOT-23; PD-(0.33W); IC-(0.5A); VCEO-(60V); -55°C TO +150°C
Q5, Q6	2	BUK9M19-60E	NEXPERIA	BUK9M19-60E	TRAN; NCH; 60V; LPAK; PD-(62W); I-(38A); V-(60V)
Q7, Q8	2	FDC3535	FAIRCHILD SEMICONDUCTOR	FDC3535	TRAN; P-CHANNEL POWER TRENCH MOSFET; PCH; SSOT-6; PD-(1.6W); I-(-2.1A); V-(-80V)
Q10	1	SI7461DP-T1-GE3	VISHAY SILICONIX	SI7461DP-T1-GE3	TRAN; P-CHANNEL 60V MOSFET; PCH; SO-8; PD-(1.9W); I-(-8.6A); V-(-60V)

MAX25605 EV Kit Bill of Materials (continued)

REF_DES	QTY	MFG PART #	MANUFACTURER	VALUE	DESCRIPTION
Q11	1	FDN342P	FAIRCHILD SEMICONDUCTOR	FDN342P	MOSFET, P-CHANNEL, SOT-23, PD = 0.5W, ID = -2.0A, VDSS = -20V, VGS = ±12V, RDS (on) = 0.062Ω
Q13, Q15	2	MMBT2907A	FAIRCHILD SEMICONDUCTOR	MMBT2907A	TRAN; SMALL SIGNAL TRANSISTOR; PNP; SOT-23; PD-(0.35W); IC-(-0.6A); VCEO-(-60V)
R1, R2, R12, R14-R16, R39, R46, R48, R70, R71	11	CRCW06032K0FK; ERJ-3EKF2001; RC0603FR-072KL; CRCW06032K00FK	VISHAY; PANASONIC; YAGEO; VISHAY	2K	RESISTOR, 0603, 2KΩ, 1%, 100PPM, 0.10W, THICK FILM
R3, R5	2	CRCW0603100KFK; RC0603FR-07100KL; RC0603FR-13100KL; ERJ-3EKF1003; AC0603FR-07100KL	VISHAY DALE; YAGEO; YAGEO; PANASONIC	100K	RESISTOR; 0603; 100K; 1%; 100PPM; 0.10W; THICK FILM
R4, R6	2	3296W-1-104LF	BOURNS	100K	RESISTOR; THROUGH-HOLE-RADIAL LEAD; 100KΩ; 10%; 100PPM; 0.5W; MOLDER CERAMIC OVER METAL FILM
R7, R8	2	CRCW060349R9FK	VISHAY DALE	49.9	RESISTOR; 0603; 49.9Ω; 1%; 100PPM; 0.10W; THICK FILM
R9, R10, R28, R31, R40, R41, R45, R47, R49, R50, R53	11	CRCW060310K0FK; ERJ-3EKF1002; AC0603FR-0710KL; RMCF0603FT10K0	VISHAY DALE; PANASONIC; YAGEO	10K	RESISTOR; 0603; 10K; 1%; 100PPM; 0.10W; THICK FILM
R11, R21, R23, R51, R56, R81-R96, R101, R102	23	CRCW06030000ZS; MCR03EZPJ000; ERJ-3GEY0R00; CR0603AJ/- 000ELF	VISHAY; ROHM SEMICONDUCTOR; PANASONIC; BOURNS	0	RESISTOR; 0603; 0Ω; 0%; JUMPER; 0.10W; THICK FILM
R13, R52, R69	3	CRCW06031M00FK; MCR03EZPFX1004	VISHAY DALE; ROHM	1M	RESISTOR, 0603, 1M Ω, 1%, 100PPM, 0.10W, THICK FILM
R17, R20	2	CRCW06033K32FK	VISHAY DALE	3.32K	RESISTOR; 0603; 3.32K; 1%; 100PPM; 0.10W; THICK FILM
R18, R19	2	CRCW06032R00FN	VISHAY DALE	2	RESISTOR, 0603, 2Ω, 1%, 100PPM, 0.10W, THICK FILM
R22, R24	2	CRCW0603100RFK; ERJ-3EKF1000; RC0603FR-07100RL	VISHAY DALE; PANASONIC	100	RESISTOR; 0603; 100Ω; 1%; 100PPM; 0.10W; THICK FILM
R25, R26	2	ERJ-8CWFR043	PANASONIC	0.043	RESISTOR; 1206; 0.043Ω; 1%; 75PPM; 1W; THICK FILM

MAX25605 EV Kit Bill of Materials (continued)

REF_DES	QTY	MFG PART #	MANUFACTURER	VALUE	DESCRIPTION
R27, R30	2	CRCW0603390KFK	VISHAY DALE	390K	RESISTOR, 0603, 390K Ω , 1%, 100PPM, 0.10W, THICK FILM
R29, R32, R103, R104	4	ERJ-8BQFR27	PANASONIC	0.27	RESISTOR; 1206; 0.27 Ω ; 1%; 250PPM; 0.5W; THICK FILM
R33, R34, R99, R100	4	CRCW08050000ZS; RC2012J000	DIGI-KEY	0	RESISTOR; 0805; 0 Ω ; JUMPER; 0.125W; THICK FILM
R35, R36, R74	3	CRCW06034K99FK; ERJ-3EKF4991	VISHAY DALE; PANASONIC	4.99K	RESISTOR; 0603; 4.99K Ω ; 1%; 100PPM; 0.10W; THICK FILM
R37, R38	2	CRCW060349K9FK; ERJ-3EKF4992	VISHAY DALE; PANASONIC	49.9K	RESISTOR; 0603; 49.9K Ω ; 1%; 100PPM; 0.10W; THICK FILM
R42-R44	3	CRCW06032003FK	VISHAY DALE	200K	RESISTOR; 0603; 200K Ω ; 1%; 100PPM; 0.10W; THICK FILM
R54, R55	2	CRCW0603330RFK	VISHAY DALE	330	RESISTOR; 0603; 330 Ω ; 1%; 100PPM; 0.10W; THICK FILM
R57, R58	2	3266W-1-503LF	BOURNS	50K	RESISTOR; THROUGH-HOLE-RADIAL LEAD; SQUARE TRIMMING POTENTIOMETER; 12 TURNS; 50K Ω ; 10%; 100PPM; ; TADJ; MOLDER CERAMIC OVER METAL FILM
R59, R61, R63, R65	4	CRCW060395R3FK	VISHAY DALE	95.3	RESISTOR; 0603; 95.3 Ω ; 1%; 100PPM; 0.10W; THICK FILM
R60, R62	2	CRCW06031K05FK	VISHAY DALE	1.05K	RESISTOR; 0603; 1.05K Ω ; 1%; 100PPM; 0.10W; THICK FILM
R64, R66	2	CRCW06032000FK	VISHAY DALE	200	RESISTOR; 0603; 200 Ω ; 1%; 100PPM; 0.10W; THICK FILM
R67, R68	2	NRC06F4220TRF	NIC COMPONENTS CORP.	422	RESISTOR; 0603; 422 Ω ; 1%; 100PPM; 0.10W; THICK FILM
R72, R73	2	CRCW08051K62FK; RM10F1621CT	VISHAY DALE; CAL-CHIP	1.62K	RESISTOR; 0805; 1.62K Ω ; 1%; 100PPM; 0.125W; THICK FILM
R97, R98	2	CRCW060382K0FK	VISHAY DALE	82K	RESISTOR, 0603, 82K Ω , 1%, 100PPM, 0.10W, THICK FILM
SCREW1-SCREW6	6	561-P440.375	GENERIC PART	P440.375	MACHINE SCREW; SLOTTED; PAN; 4-40IN; 3/8IN; NYLON
SPACER1-SPACER8	8	9032	KEYSTONE	9032	MACHINE FABRICATED; ROUND-THRU HOLE SPACER; NO THREAD; M3.5; 5/8IN; NYLON
SW1, SW2	2	100SP1T1B1M1QEHE	E-SWITCH	100SP1T1B1M1QEHE	SWITCH; SPDT; THROUGH HOLE; STRAIGHT; +28VDC; 5A; RINSULATION = 1G Ω

MAX25605 EV Kit Bill of Materials (continued)

REF_DES	QTY	MFG PART #	MANUFACTURER	VALUE	DESCRIPTION
SW3-SW10	8	GT11MCBE	C&K	GT11MCBE	SWITCH; TGL; TH; STRAIGHT; 20V; GT SERIES; RCOIL = 0.05Ω; RINSULATION = 1GΩ
TP1	1	7006	KEYSTONE	7006	CONNECTOR; PANELMOUNT; BINDING POST; STRAIGHT THROUGH; 1PIN; RED
TP2	1	7007	KEYSTONE	7007	CONNECTOR; PANELMOUNT; BINDING POST; STRAIGHT THROUGH; 1PIN; BLACK
U1	1	MAX25605ATP/VY+	MAXIM	MAX25605ATP/VY+	EVKIT PART - IC; MAX25605ATP/VY+; 6 SWITCH SEQUENTIAL CONTROLLER; TQFN20-EP; PACKAGE CODE: T2044Y+3C; PACKAGE OUTLINE NUMBER: 21-100068; LAND PATTERN NUMBER: 90-0037
U2	1	MAX25605AUP/V+	MAXIM	MAX25605AUP/V+	EVKIT PART - IC; MAX25605AUP/V+; 6 SWITCH SEQUENTIAL CONTROLLER; TQFN20-EP; PACKAGE CODE: U20E+3C; PACKAGE OUTLINE: 21-100132; PACKAGE LAND PATTERN: 90-100049
U3, U4	2	MAX25611AATC/VY+	MAXIM	MAX25611AATC/VY+	IC; CTRL; AUTOMOTIVE HIGH-VOLTAGE HB LED CONTROLLER; TQFN12-EP
U5	1	MAX9031AUK+	MAXIM	MAX9031AUK+	IC; COMP; LOW-COST; ULTRA-SMALL; SINGLE; SINGLE-SUPPLY COMPARATORS; SOT23-5
U6	1	MAX5084ATT+	MAXIM	MAX5084ATT+T	IC; VREG; LOW-QUIESCENT-CURRENT LINEAR REGULATOR; TDFN6
PCB	1	MAX25605	MAXIM	PCB	PCB:MAX25605
COVER1	1	MAX25605_COVER	MAXIM	MAX25605_COVER	COVER; EVKIT; MAX25605; 4.2INX1.9INX0.125IN; ACRYLIC

MAX25605 EV Kit Schematic

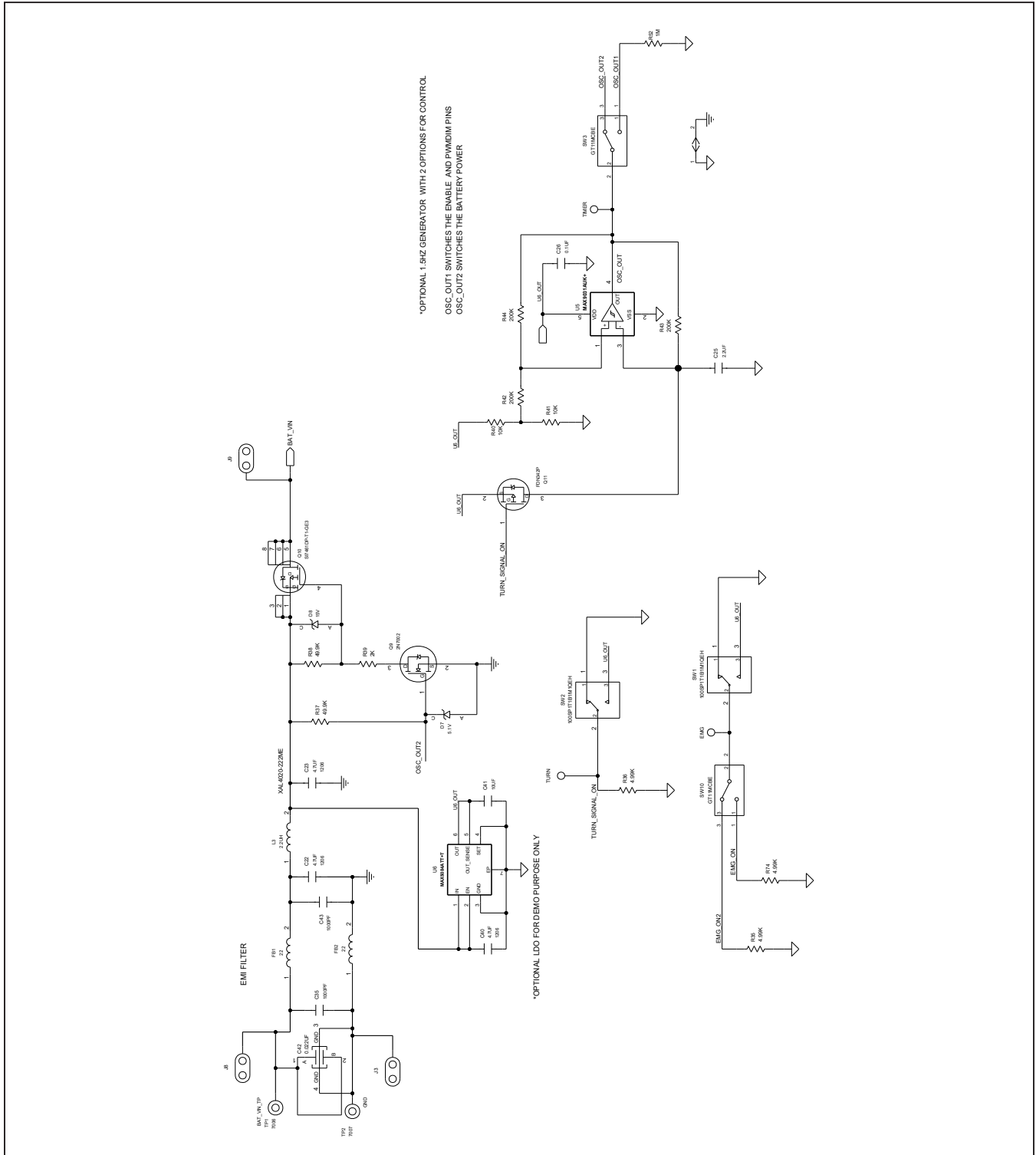

MAX25605 EV Kit Schematic (continued)

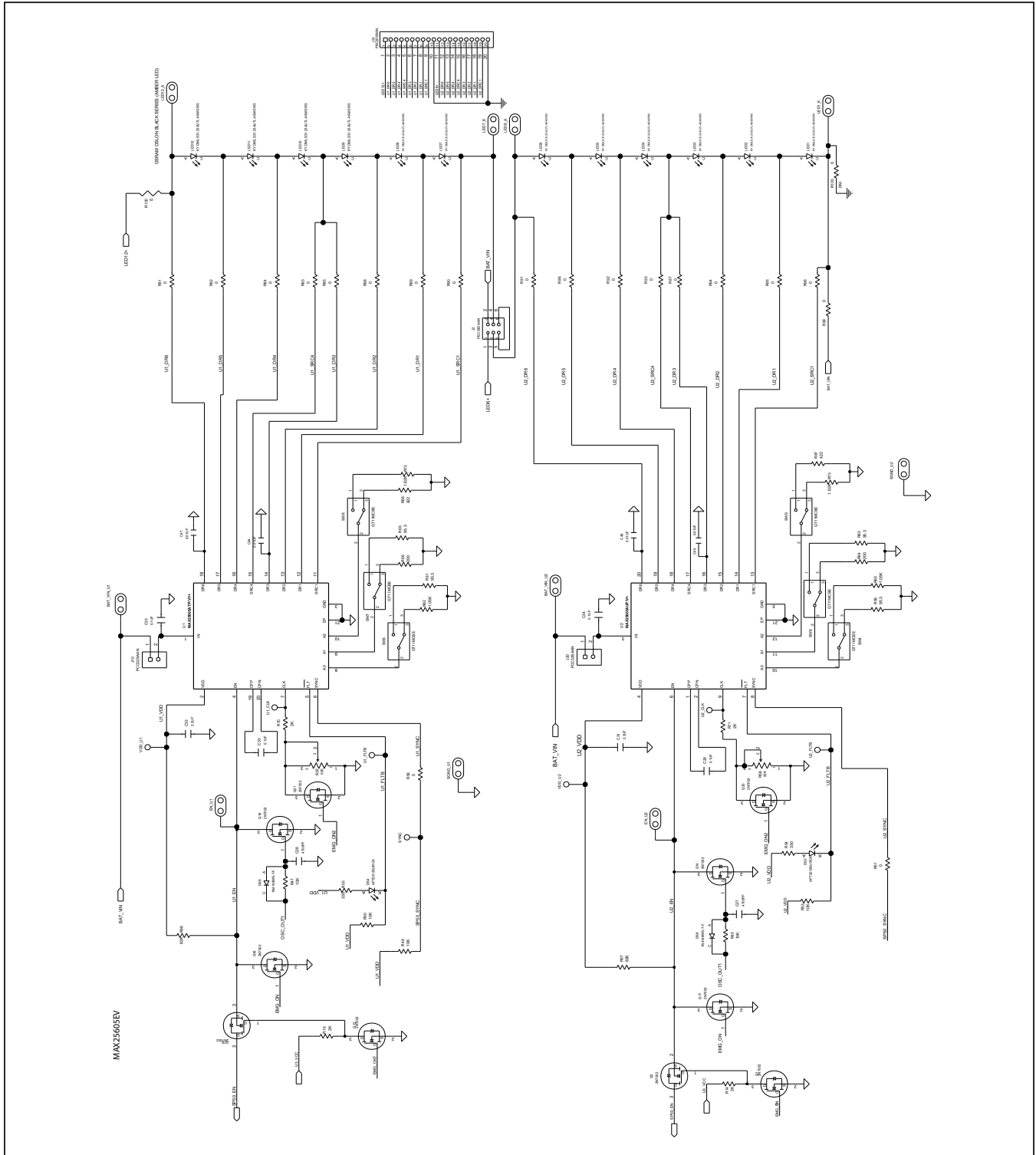

MAX25605 EV Kit PCB Layouts

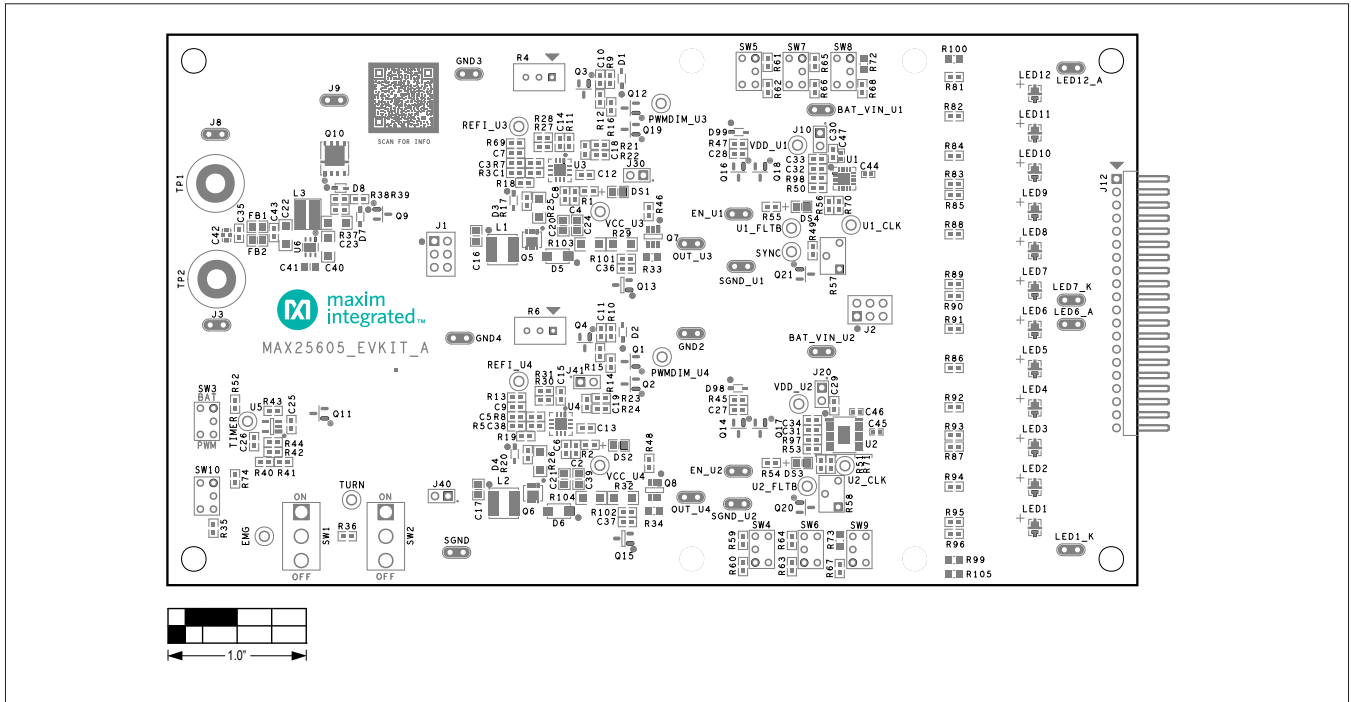

MAX25605 EV Kit PCB Layout—Top Silkscreen

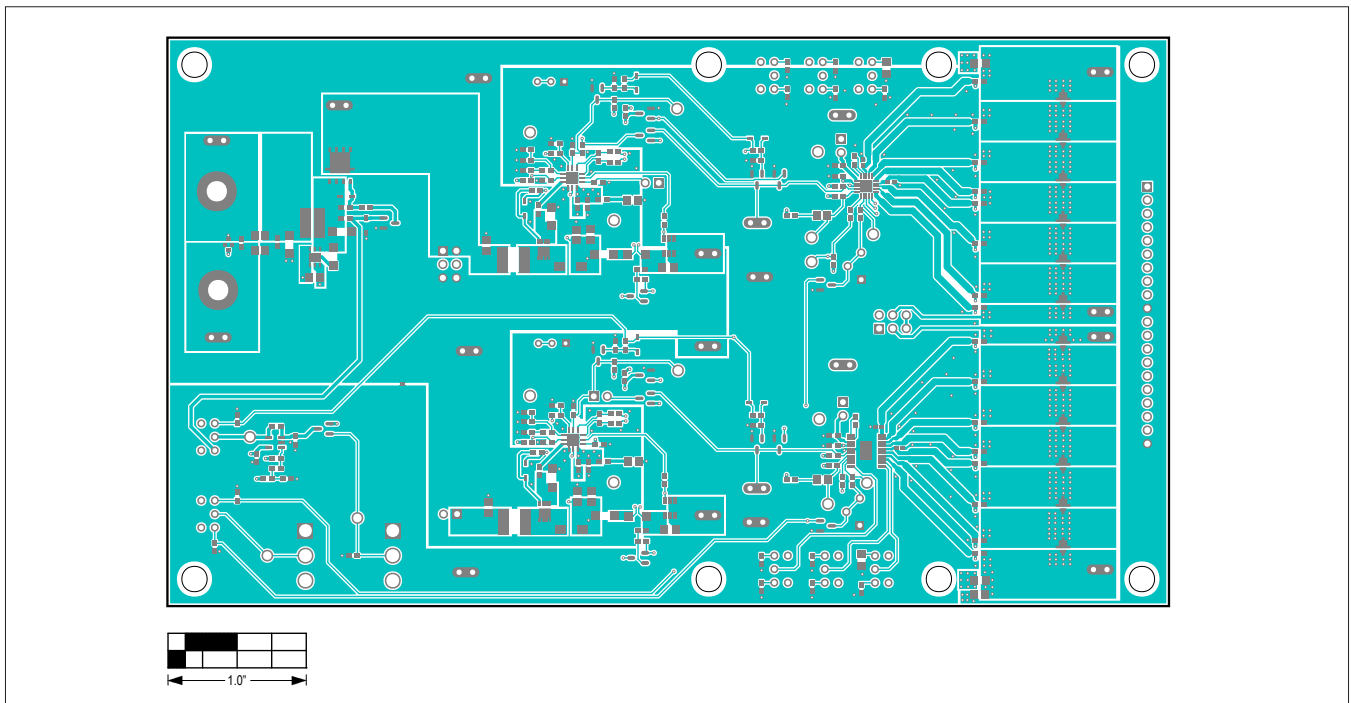

MAX25605 EV Kit PCB Layout—Top View

MAX25605 EV Kit PCB Layouts (continued)

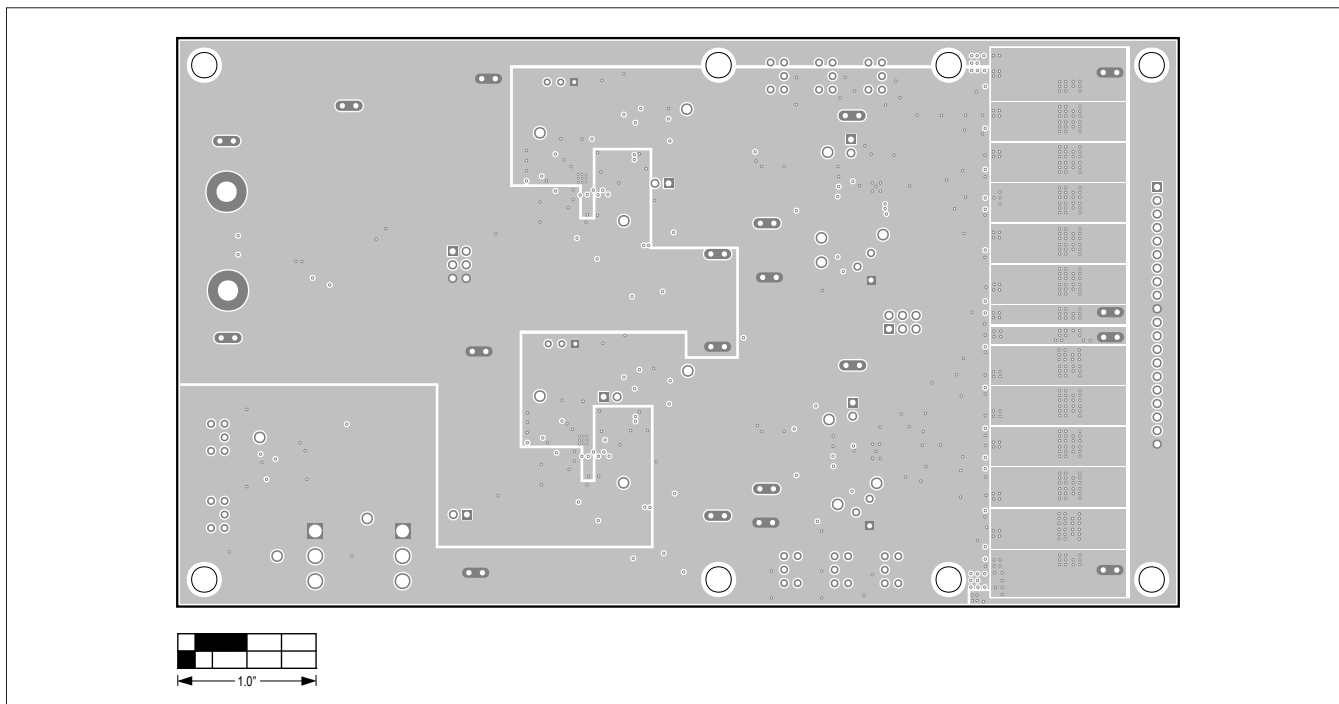

MAX25605 EV Kit PCB Layout—Layer 2

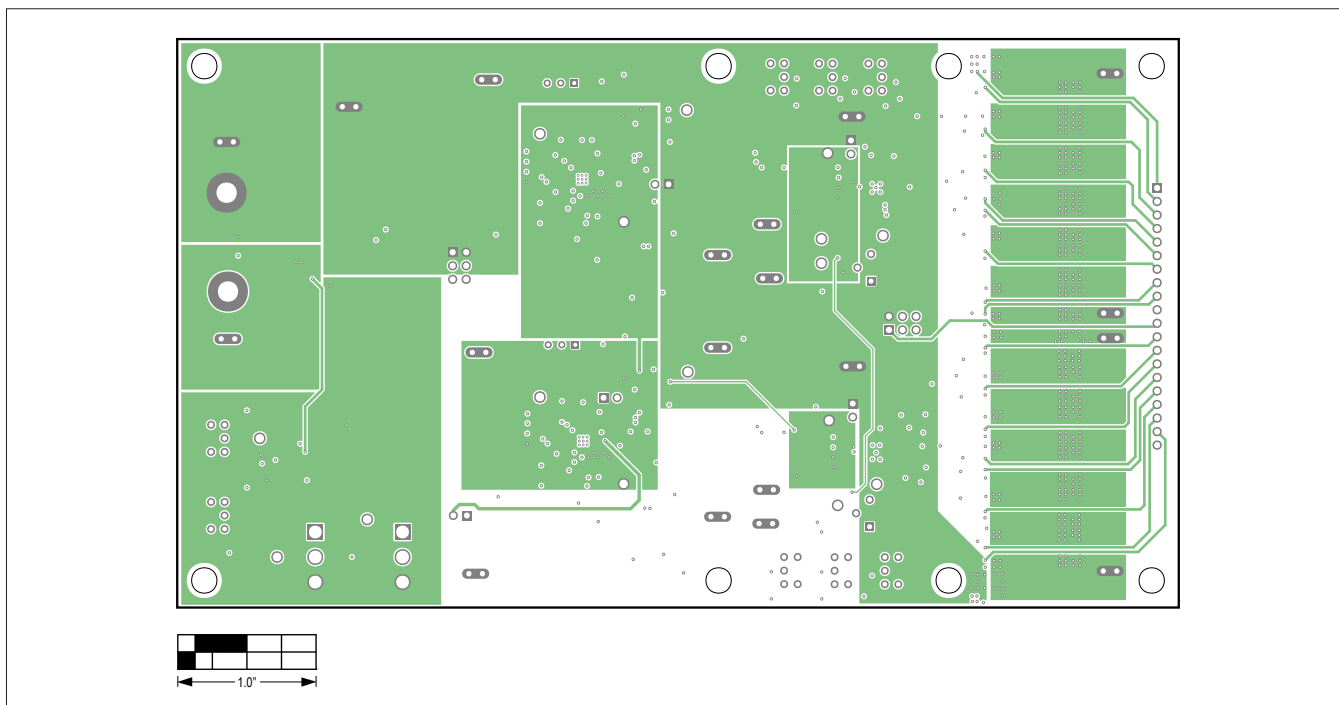

MAX25605 EV Kit PCB Layout—Layer 3

MAX25605 EV Kit PCB Layouts (continued)

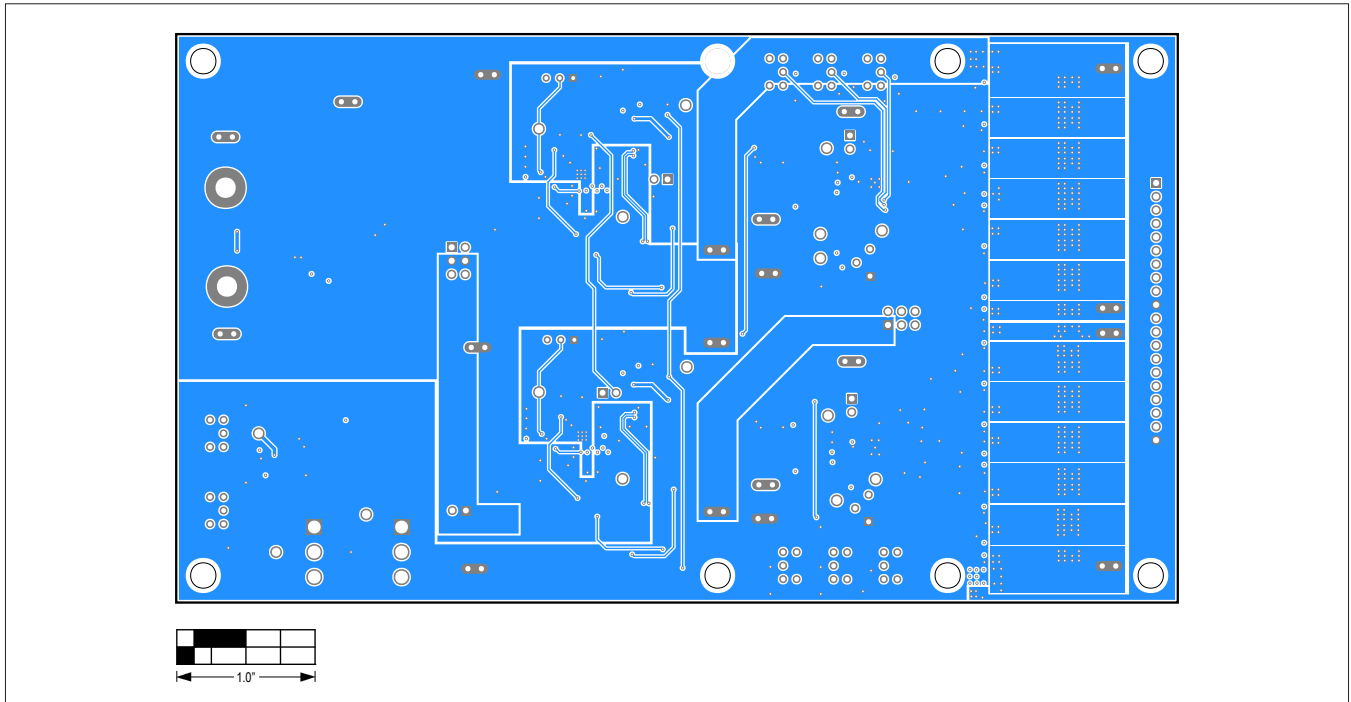

MAX25605 EV Kit PCB Layout—Bottom View