

## MAX28200 Evaluation Kit

Evaluates: MAX28200

### General Description

The MAX28200 evaluation kit (EV kit) is a development platform that enables access to all the features of the MAX28200 in a tiny, easy-to-use board. The ROM-based bootloader is accessed through JTAG or an I<sup>2</sup>C interface. Connectors are provided for a host bus adapter, the DS9481P programming tool, and for JTAG. Board power can be supplied by USB, host bus adapter, JTAG, or the DS9481P programming tool. This board provides a powerful processing subsystem in a very small space that can be easily integrated into a variety of applications.

### EV Kit Contents

- MAX28200 EV kit board with a sample device preprogrammed with demo
- DS9481P-300# programming tool
- USB Type-A to Micro-B cable

### Features

- MAX28200 Microcontroller
  - MAXQ20 16-Bit Core
  - 16KB Flash Memory
  - 2KB SRAM
  - PWM/Timer
  - 2-Channel, 10-Bit ADC
  - I<sup>2</sup>C
  - Hardware SHA-3 Engine
  - Comparator
- Integrated Peripherals
  - Status LEDs
  - Temperature Sensor
  - Potentiometer

*Ordering Information appears at end of data sheet.*

### MAX28200 EV Kit Board

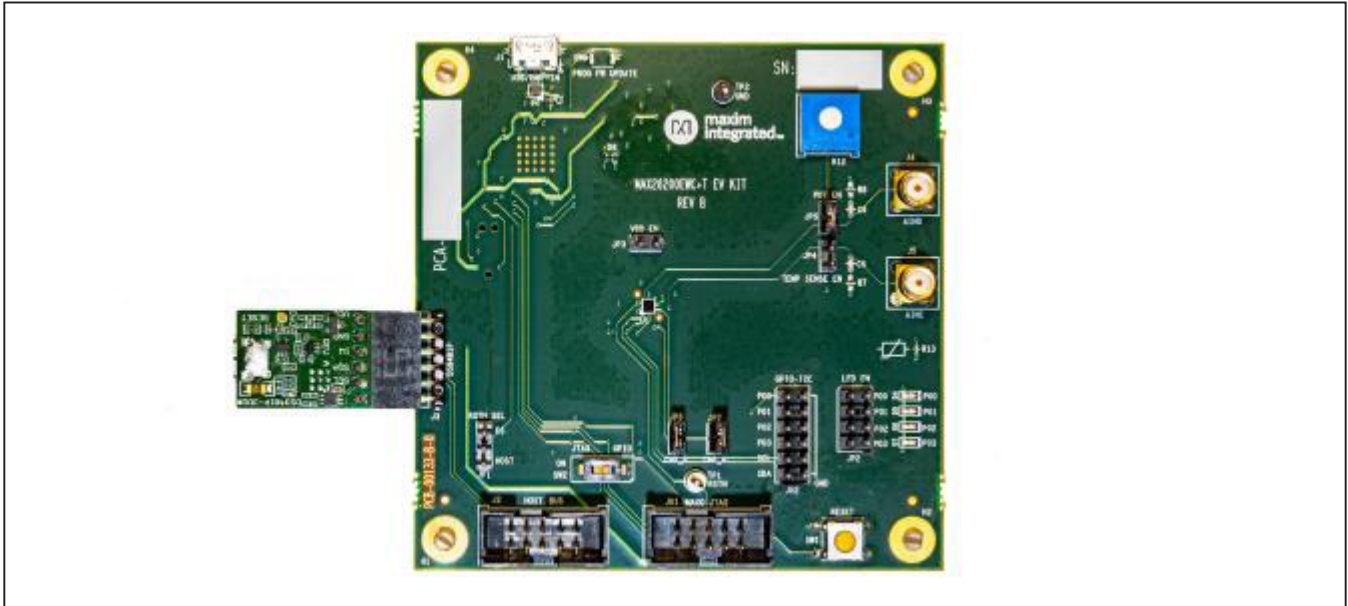

### Software Requirements

- NET Framework 4.0—Setup automatically downloads and installs, if needed.
- USB drivers (DS9481P-300.inf and DS9481P-300.cat files)
- MAX28200 EV Kit Software

### Hardware Requirements

- DS9481P-300 USB to 1-Wire®/I2C adapter
- MAX28200 EV Kit board
- Mini USB cable

### Driver Installation

Follow these steps prior to plugging in the DS9481P-300 into a USB port:

- 1) Download and fully extract the MAX28200 EV kit software from <https://www.maximintegrated.com/en/design/software-description.html/swpart=SFW0008060B>.
- 2) Click on the **I accept the agreement** radio button in the **Software License Agreement** pop-up window and press **OK**.
- 3) Sign into your MyMaxim account to download the ZIP file.
- 4) Right click on the DS9481P-300.inf and select **Install** from the pop-up menu.
- 5) Once the operation completes successfully, plug in the device into a USB port. Then plug the device into the

EV kit board with the silkscreen signal names facing up, as shown in the [MAX28200 EV Kit Board](#) photo.

- 6) Confirm the device appears as shown in [Figure 2](#).
- 7) Proceed to the [Software Installation](#) section.

### Software Installation

This section describes how to install the MAX28200 EV kit software.

- 1) Start the installation process by double-clicking on the setup.exe file.
- 2) A pop-up window appears. Confirm the publisher is Maxim Integrated prior to clicking the **Install** button.

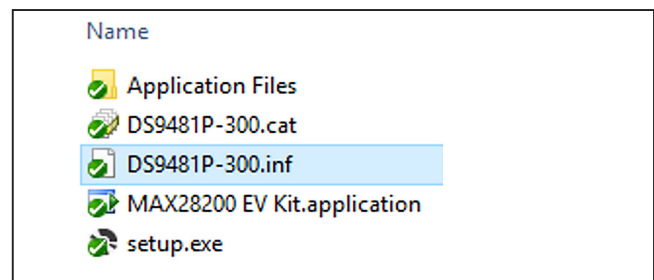

Figure 1. Contents of MAX28200 EV Kit Folder

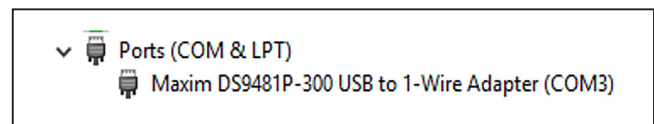

Figure 2. Device Manager Confirming Device Is Recognized

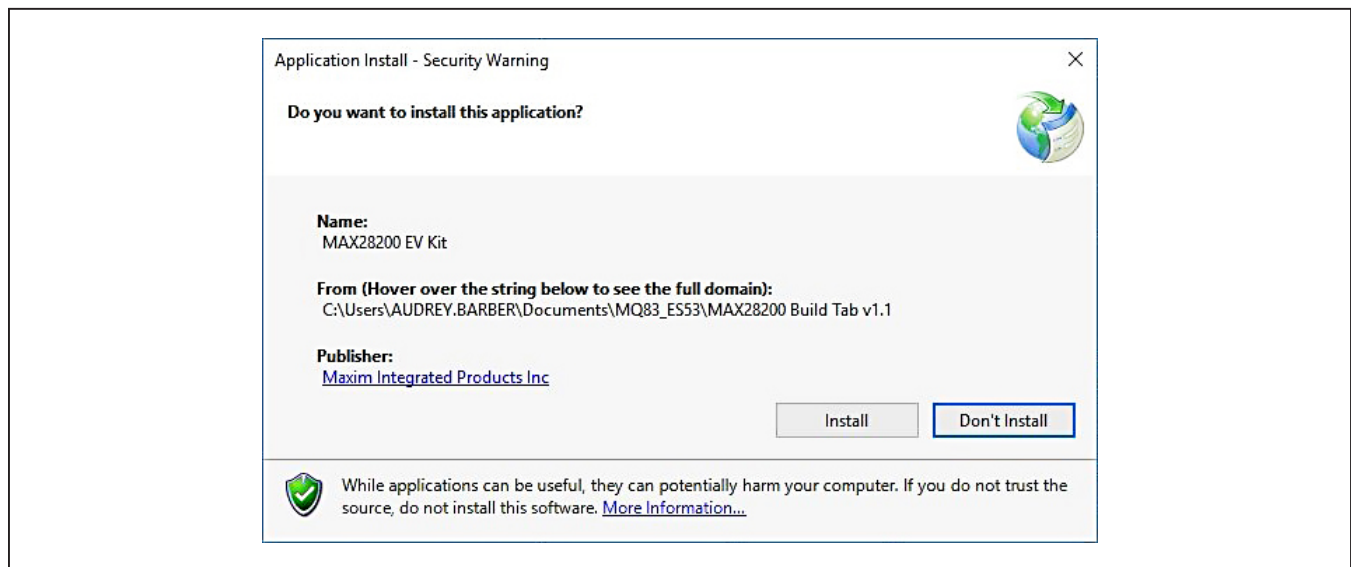

Figure 3. Installation Dialog Box

- 3) Click on the **I accept the agreement** radio button in the **Software License Agreement** pop-up window and click **OK**.
- 4) The splash screen momentarily displays, followed by the application's main form.
- 5) If the device is not detected, go to the **Tools** menu and click **Connect** (Figure 4).
- 6) See the [Loading Hex File into the MAX28200](#) section for instructions on using the software application.
- 7) To restart the software, use the shortcut located at **Start Menu | MAX28200 EV Kit**.

**IMPORTANT:** Do not attempt to launch the program using **setup.exe** or any files in the same directory because this will install multiple instances of the application. Only use the shortcut link after the initial setup is complete.

## Quick Start

The EV kit is fully assembled, tested, and preprogrammed with demo firmware, EvKitTest.hex. Follow the steps below to begin evaluation with this FW:

- 1) Inspect the installed jumpers, which should match the defaults specified in [Table 1](#).
- 2) Set the switch SW2 to GPIO mode (open).
- 3) Power the board by connecting the supplied USB cable to a PC or USB 5V source, or alternately by connecting the USB cable to the DS9481P that is in turn connected to J3.

- 4) Verify that the demo is running by observing the LEDs blinking in a pattern.
- 5) Evaluate the analog input by turning the potentiometer R12 fully clockwise and then fully counter-clockwise two times and observe the LEDs change.
- 6) Touch the thermistor R13 with your finger. You should observe the LEDs change three times.
- 7) If desired, press the RESET button to start over. To retest, allow the thermistor to cool for several seconds and then press the reset button before testing again.
- 8) To use the MAX28200 as an I<sup>2</sup>C master when evaluating the MAX28200 as a PMIC companion, make sure to remove the jumpers on Port 0 and Port 1 on JP2.

## Detailed Description of Hardware (or Software)

The MAX28200 EV kit board is designed to make developing with the MAX28200 quick and easy. In addition to making all the GPIOs accessible at 100mil pitch headers, the EV kit also offers programming access to flash memory using a ROM-resident bootloader. Electrical interface to the bootloader is by JTAG or I<sup>2</sup>C. I<sup>2</sup>C can be accessed through connectors for a host bus adapter or the included DS9481P programming tool. Configurable status LEDs and a thermistor plus potentiometer provide a convenient way to monitor port activity and exercise the ADC/comparator block.

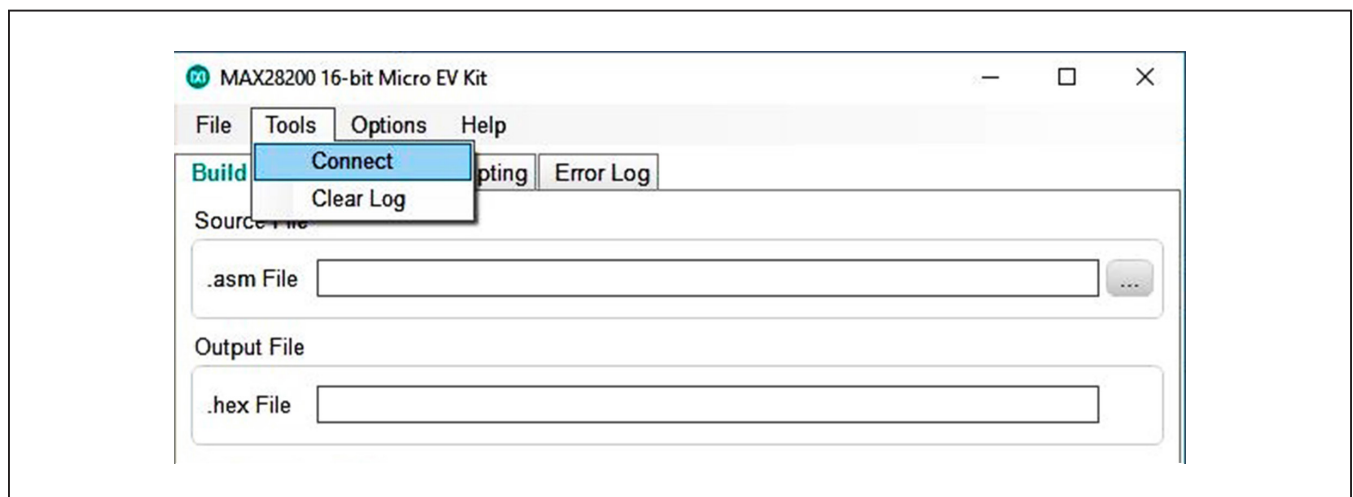

Figure 4. Connecting to Device

### Programming the MAX28200

The [Loading Hex File into the MAX28200](#) section presents the most straightforward use case for the MAX28200, in which the MAX28200 is programmed directly with firmware that is already in a hex file format. The [Using the Assembler to Create Hex Files](#) and [Creating I2C Master Firmware from the CSV File](#) sections show the versatility of the EV kit software and showcase its ability to take an assembly or CSV file, and convert either file format into a hex file that can be used to program the MAX28200.

The [Using the Assembler to Create Hex Files](#) section reviews the first case, in which an assembly file is converted into a hex file and then is used to program the MAX28200. Assembly language allows for a wide range of applications and highly efficient device operation.

The [Creating I2C Master Firmware from the CSV File](#) section shows the steps to create and load the firmware necessary to implement an I<sup>2</sup>C master that programs volatile registers in I<sup>2</sup>C slaves at power-up. One example of an I<sup>2</sup>C slave that can be programmed by the MAX28200 is the MAX77714 PMIC, which has an EV Kit GUI capable of generating a compatible .csv file. For other cases where the .csv file is being built manually, make sure to use the following format: Slave, Address, Name, Hex. If the MAX28200 is being used as a PMIC companion, see Step 8 in the [Quick Start](#) section.

### Loading Hex File into the MAX28200

- 1) From the **Start** menu, select **MAX28200 EV Kit**.
- 2) Select the **Boot Loader** tab ([Figure 6](#)).
- 3) Select the **File** tab and click **Open Intel Hex File** and navigate to the desired .hex file ([Figure 7](#)).
- 4) For faster performance, make sure that the bootloader data log is off. Do this by clicking the **Options** tab at the top, hovering over **Bootloader Data Log**, and selecting **OFF** ([Figure 8](#)).

- 5) Click the **Program/Verify** button to program the device ([Figure 9](#)).
- 6) If this operation was successful, you will see “//Programming Successful!” at the bottom of the log ([Figure 10](#)).

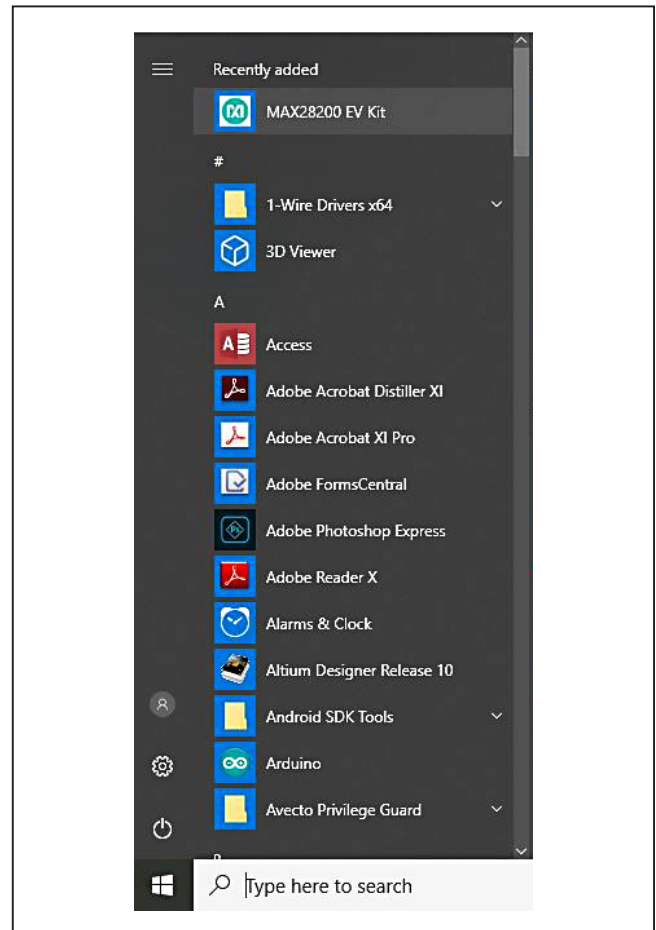

Figure 5. Windows Start Menu to Start EV Kit Program

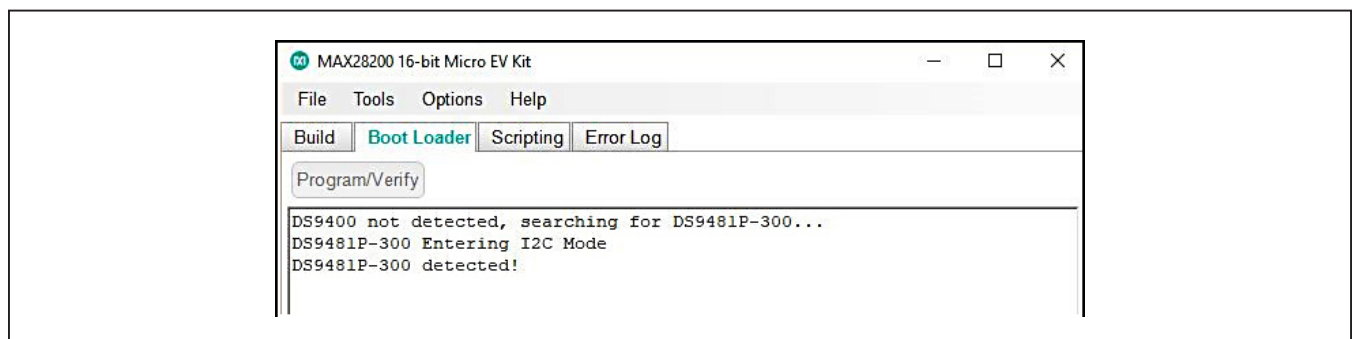

Figure 6. DS9481 Device Detected. If a Device Is Not Detected, See Step 5 in the [Software Installation](#) Section.

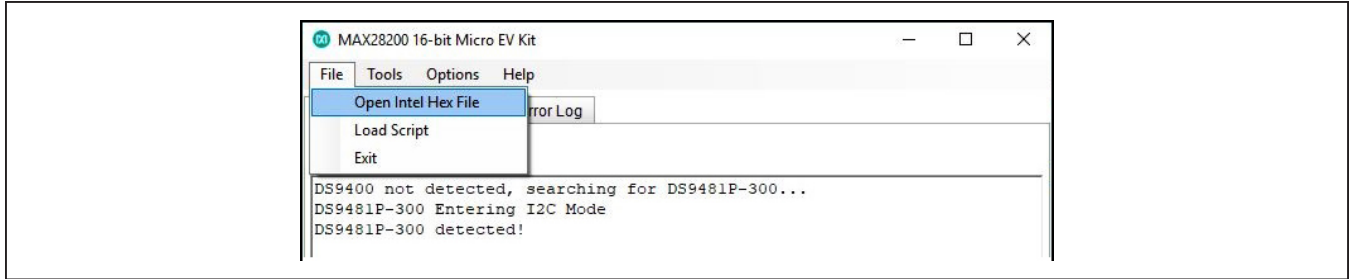

Figure 7. Select .hex File to Load into the Device

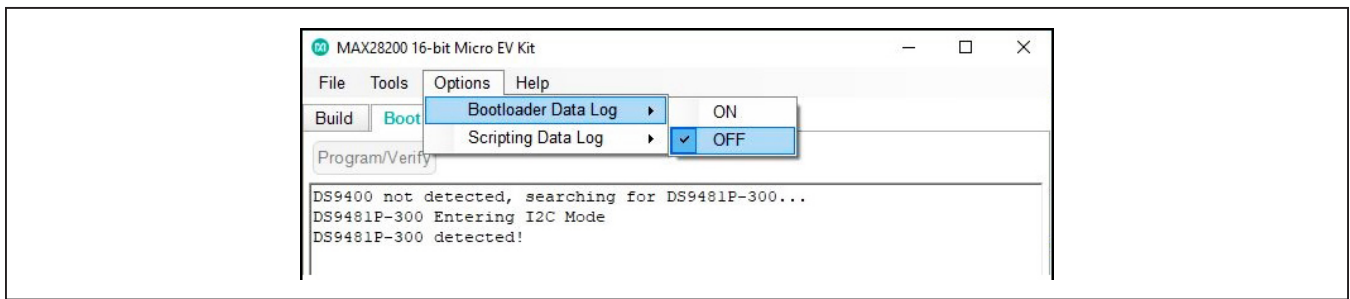

Figure 8. Turning Off the **Bootloader Data Log** for Faster Performance

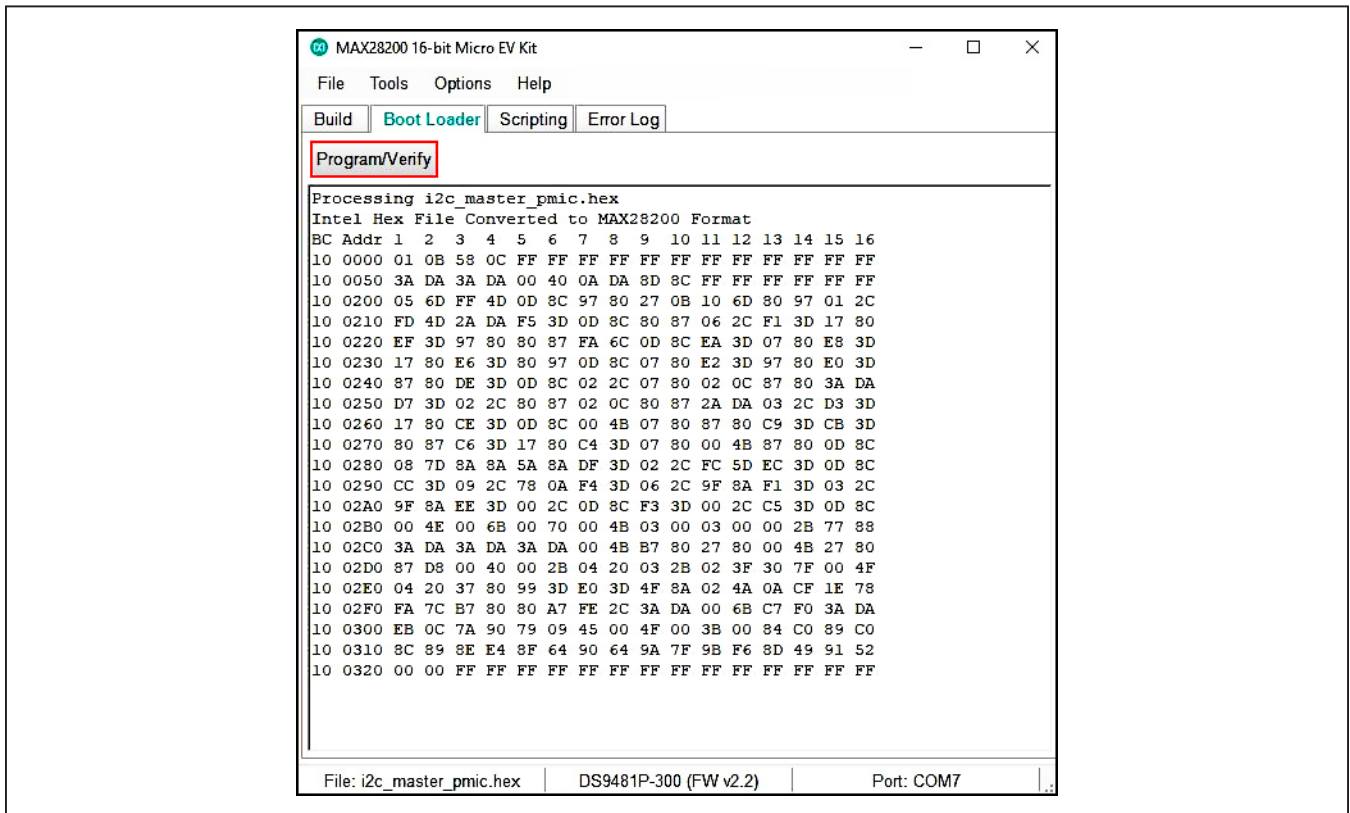

Figure 9. Programming Device

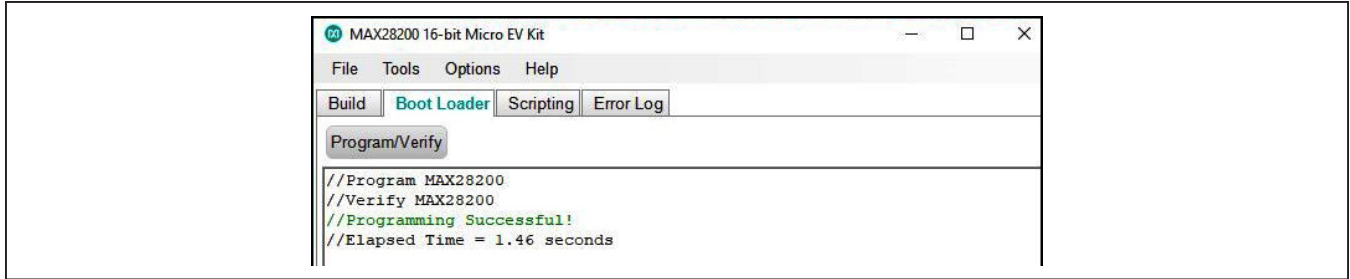

Figure 10. Device Successfully Programmed

### Using the Assembler to Create Hex Files

- 1) From the **Windows Start** menu, select **MAX28200 EV Kit** (Figure 11).

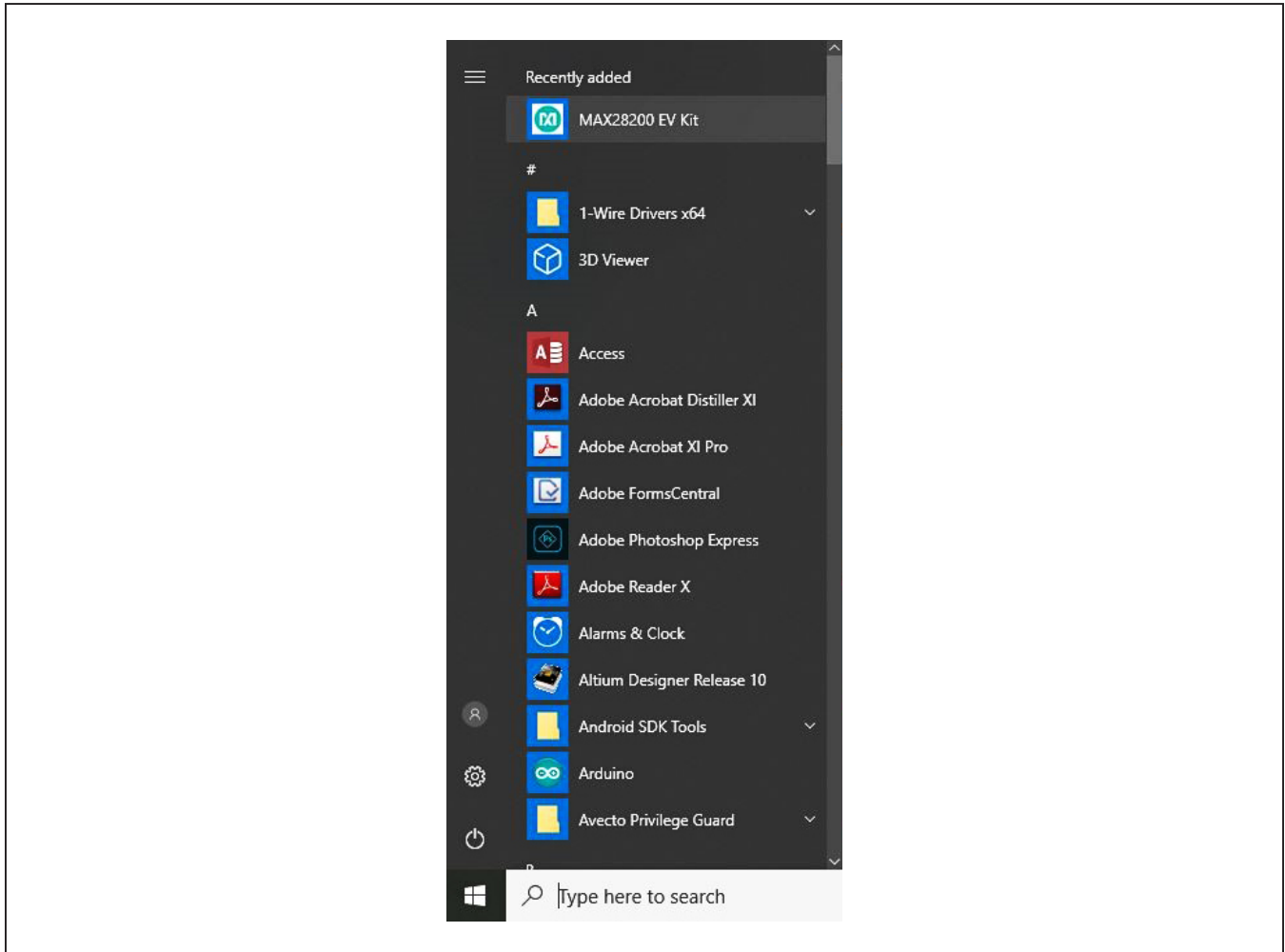

Figure 11. Windows Start Menu to Start EV Kit Program

- 2) On the **Build** tab, click the ... button to the right of the **Source File** text box to select an .asm file (Figure 12).

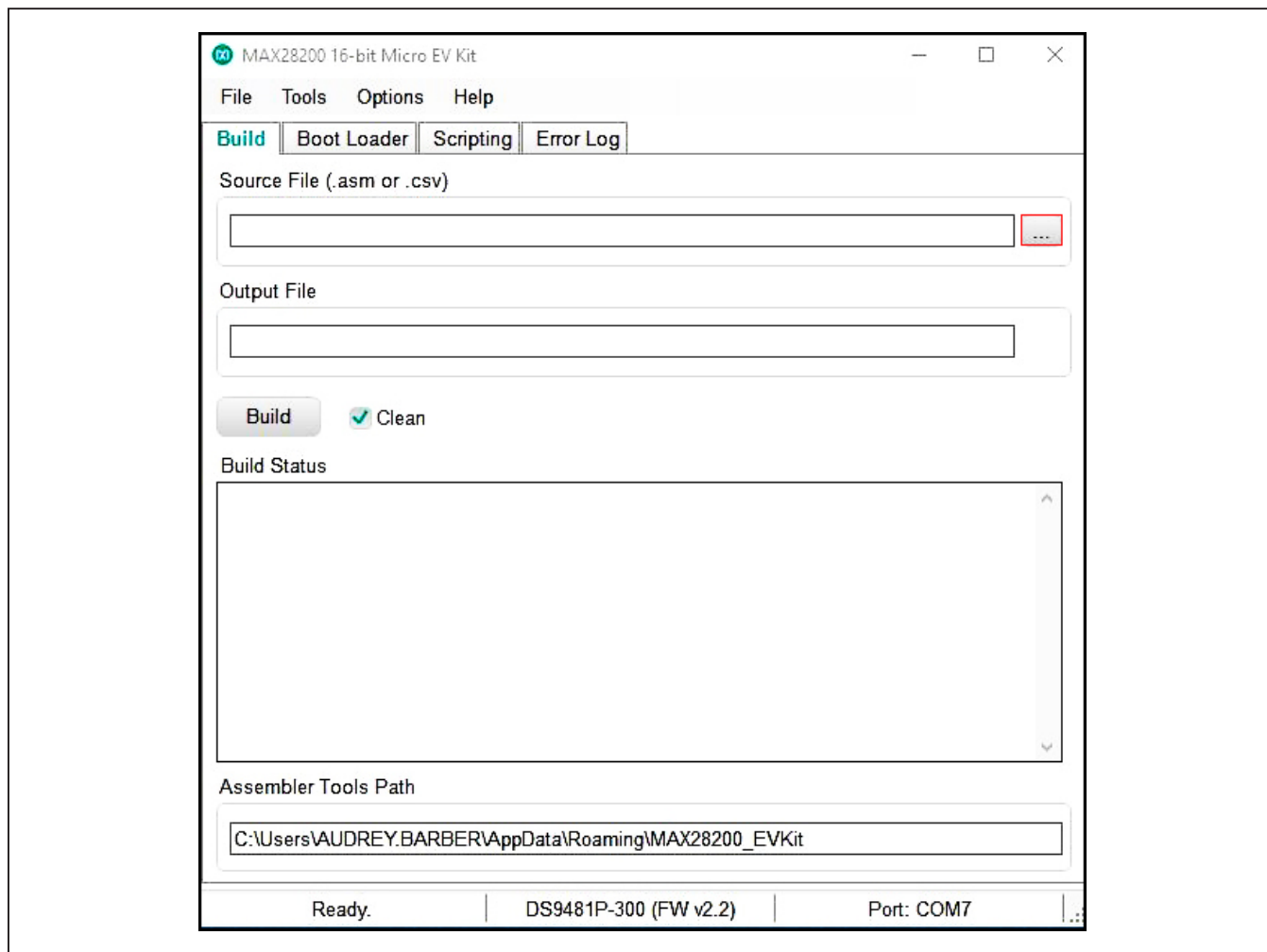

Figure 12. Select an .asm File from the Directory to Convert into .hex File

3) Once the file is selected, click the **Build** button to build the assembly file (Figure 13).

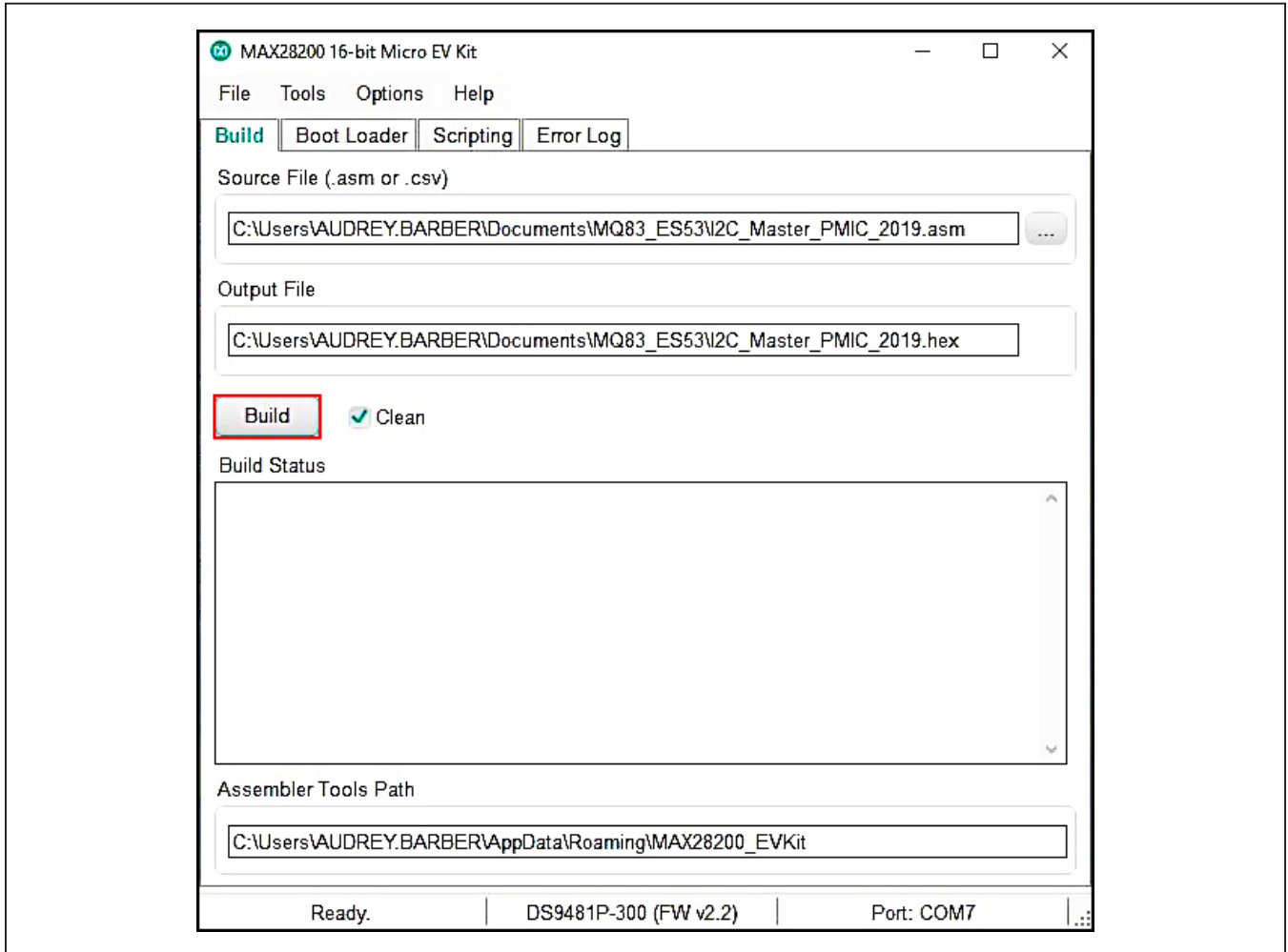

Figure 13. Build the hex file from the original assembly file.



- 4) This action produces a successful completion message (Figure 14) and a hex file of the same name (shown in the **Output File** text box) appears in the directory with the .hex file extension.

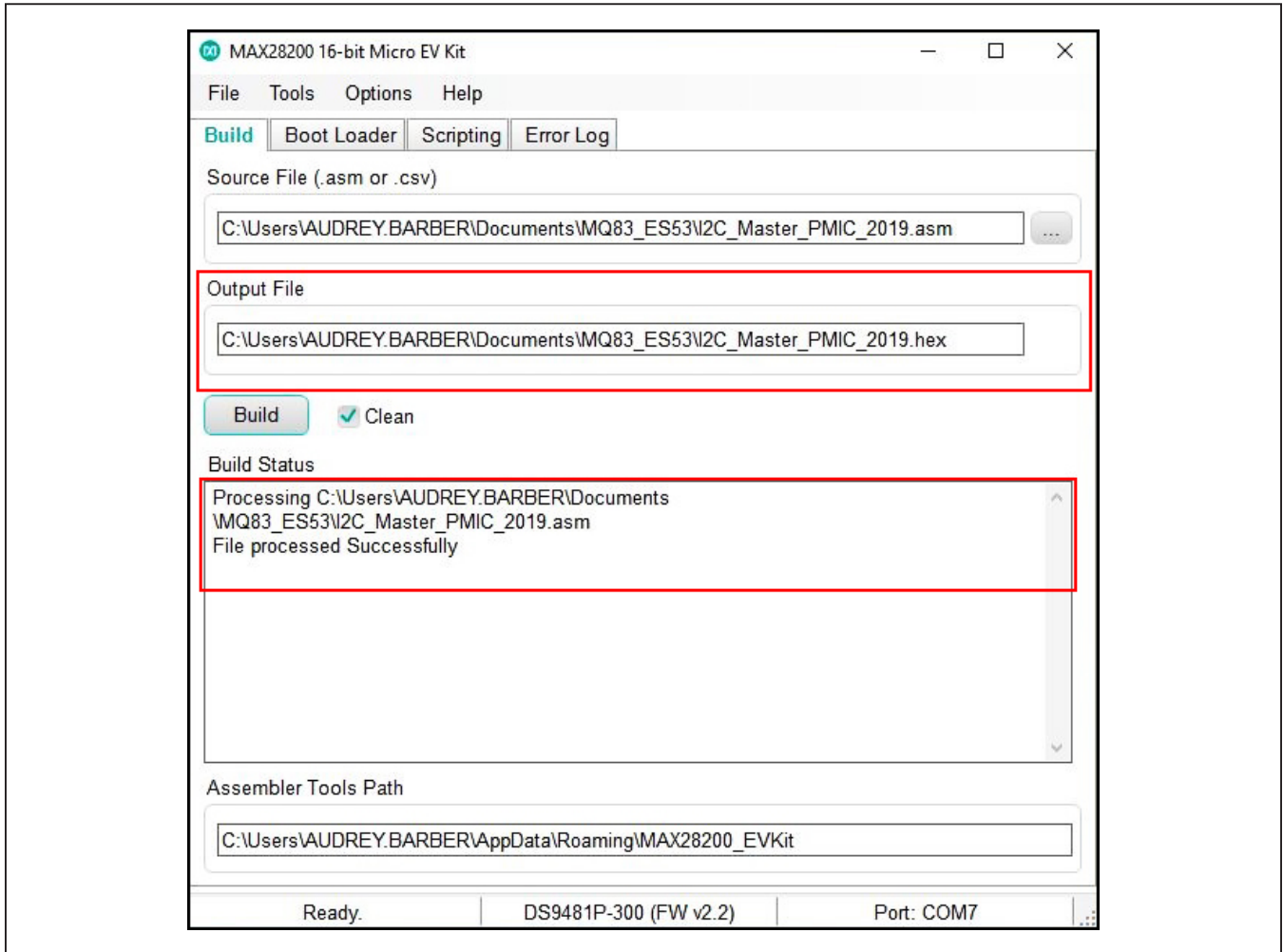

Figure 14. Assembly File Successfully Converted into .hex File

- 5) Go to the **Boot Loader** tab, and under the **File** menu, select **Open Intel Hex File**. Choose the .hex file that was created from the original assembly file (Figure 15).
- 6) The data pattern appears (Figure 16). Click the **Program/Verify** button to program the MAX28200.

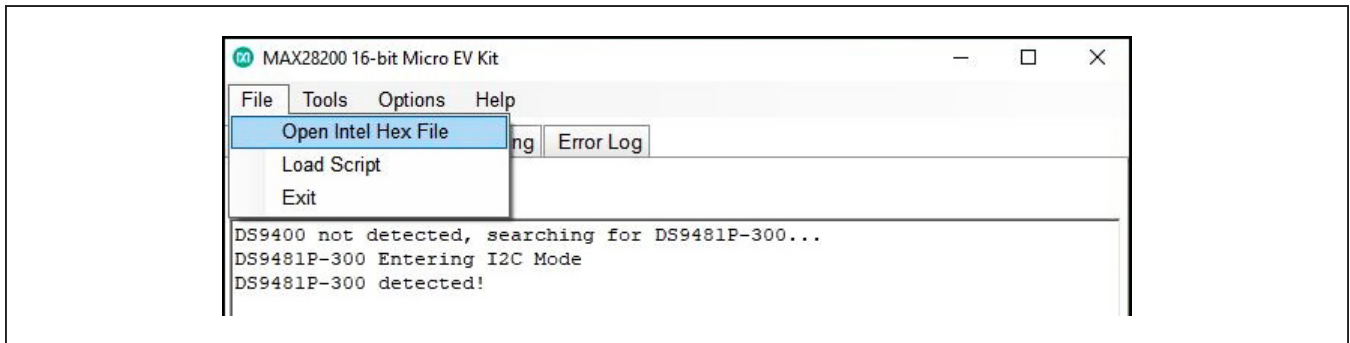

Figure 15. Programming Device with Selected Script

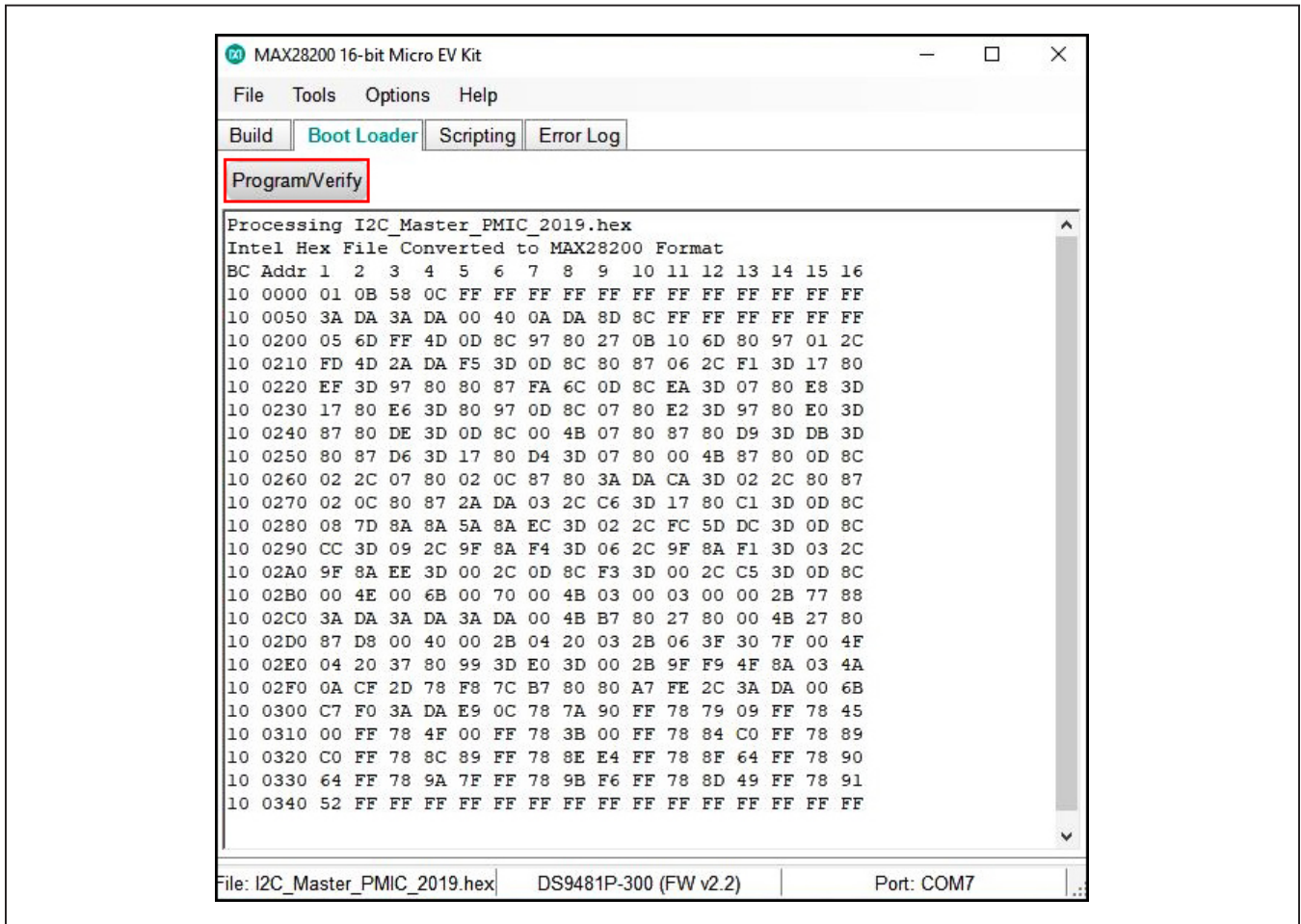

Figure 16. Program the Device with the Data Pattern

7) If this operation is successful, **Programming Successful!** appears at the bottom of the log.

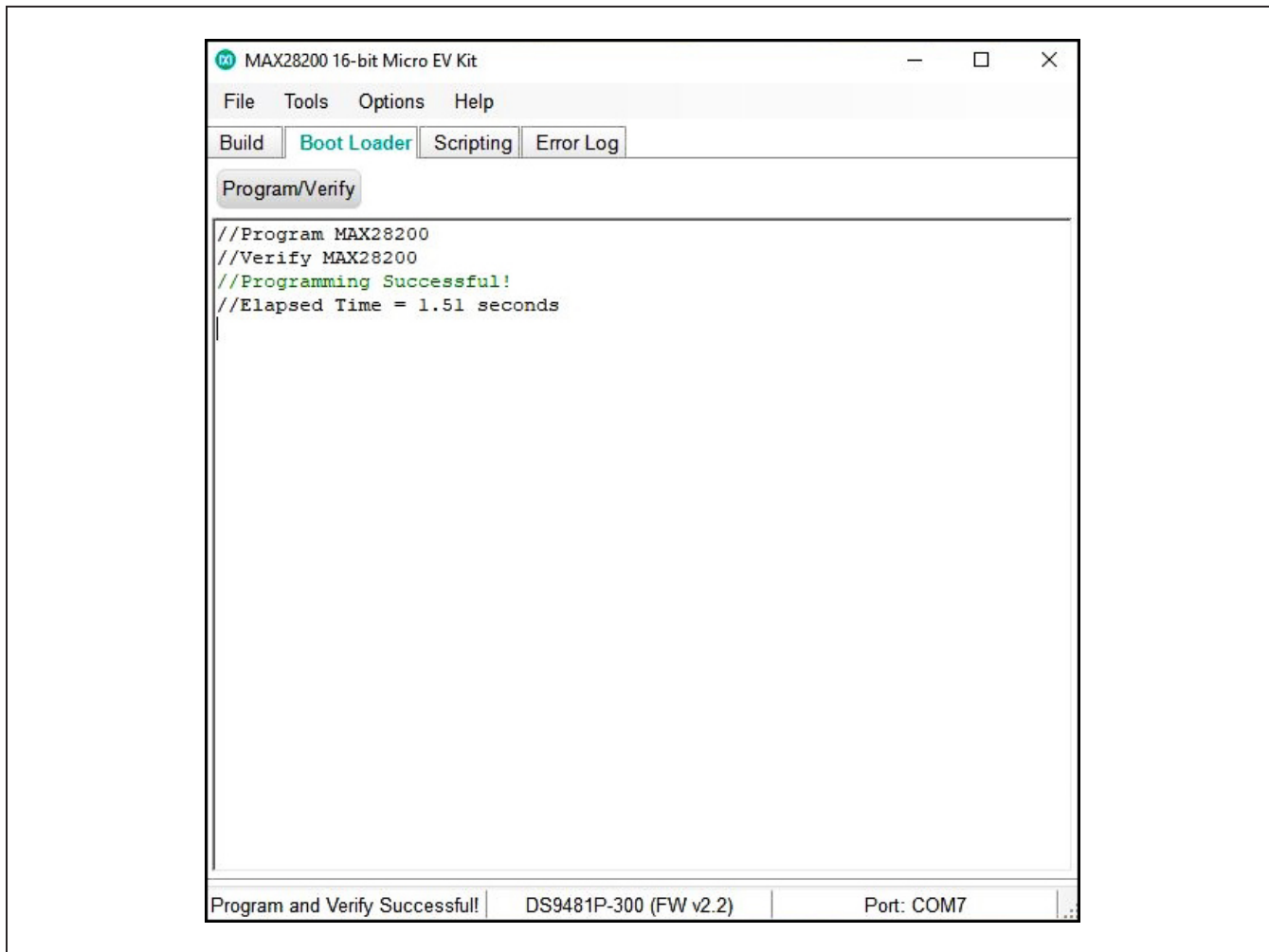

Figure 17. Device successfully programmed.

### Creating I<sup>2</sup>C Master Firmware from the CSV File

- 1) From the **Windows Start** menu, select **MAX28200 EV Kit**.
- 2) On the **Build** tab (Figure 19), click ... button to the right of the **Source File** field to select a .csv file.
- 3) When the file viewer window appears, be sure to change from the default **Assembly files** to **CSV files** in the bottom right corner drop-down menu to display the CSV files within the directory (Figure 20).
- 4) Once the file is selected, click the **Build** button to build the CSV file (Figure 21).
- 5) This action produces a successful completion message (Figure 22). A .hex file of the same name (shown in the **Output File** text box) appears in the directory with the .hex file extension.

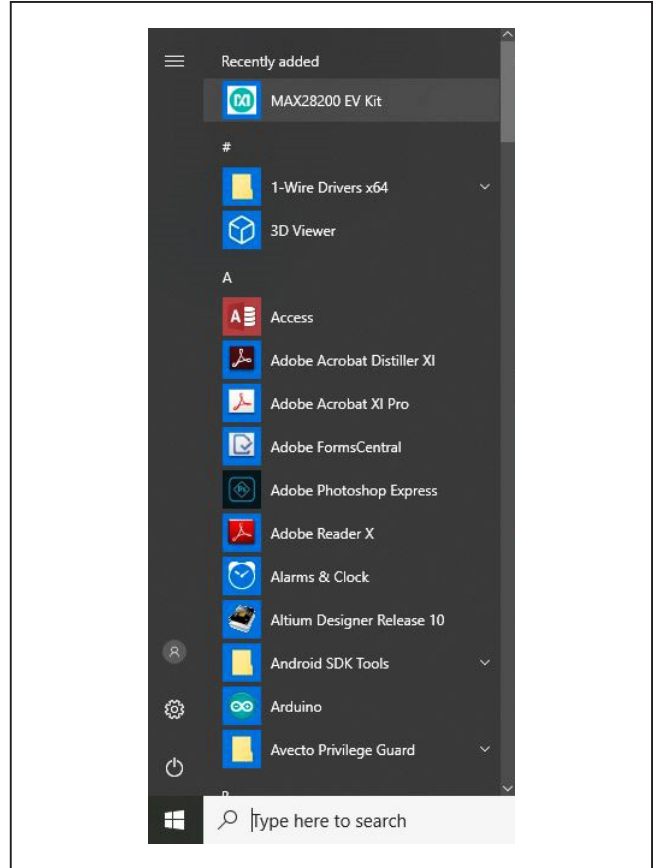

Figure 18. Windows Start Menu to Start EV Kit Program

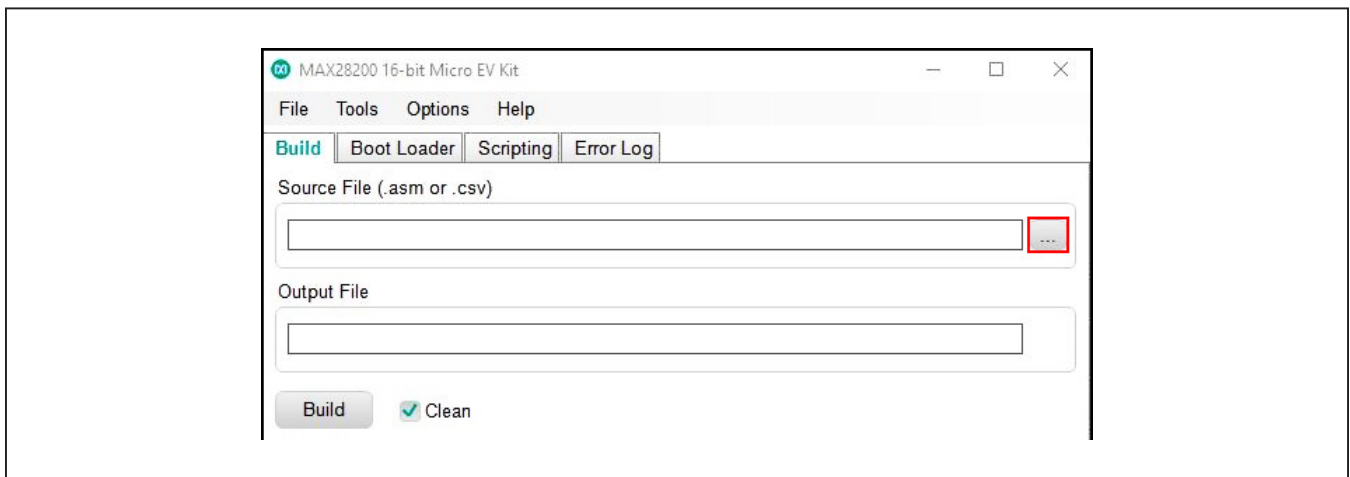

Figure 19. Selecting a .csv File from the Directory to Convert into .hex File



Figure 20. Select the “CSV files” option in the bottom right hand corner of the file viewer window to display the csv files.

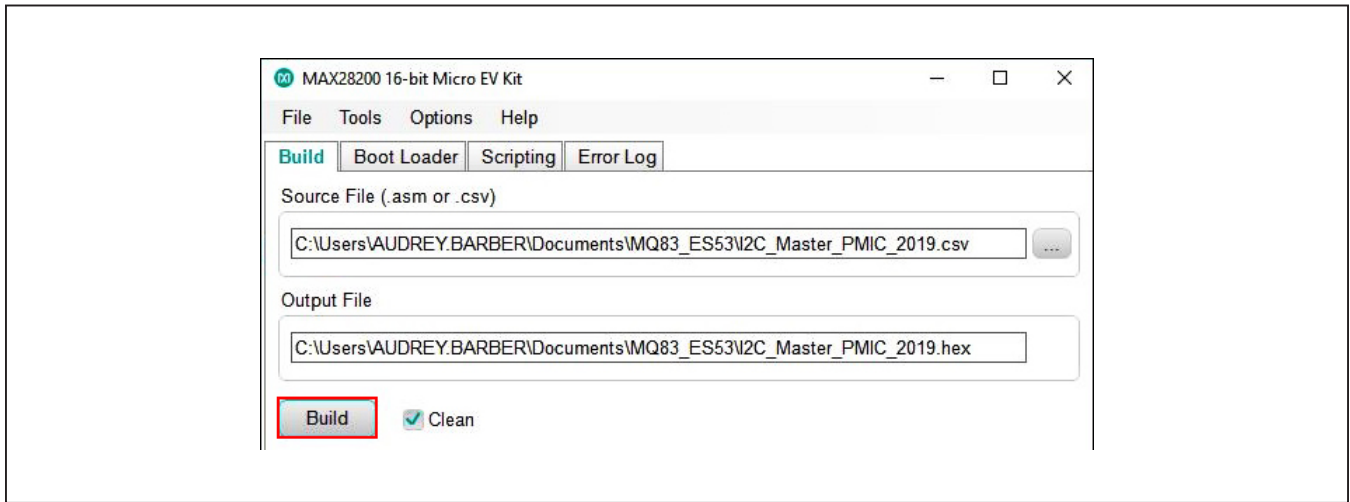

Figure 21. Building the .hex File from the Original .csv File

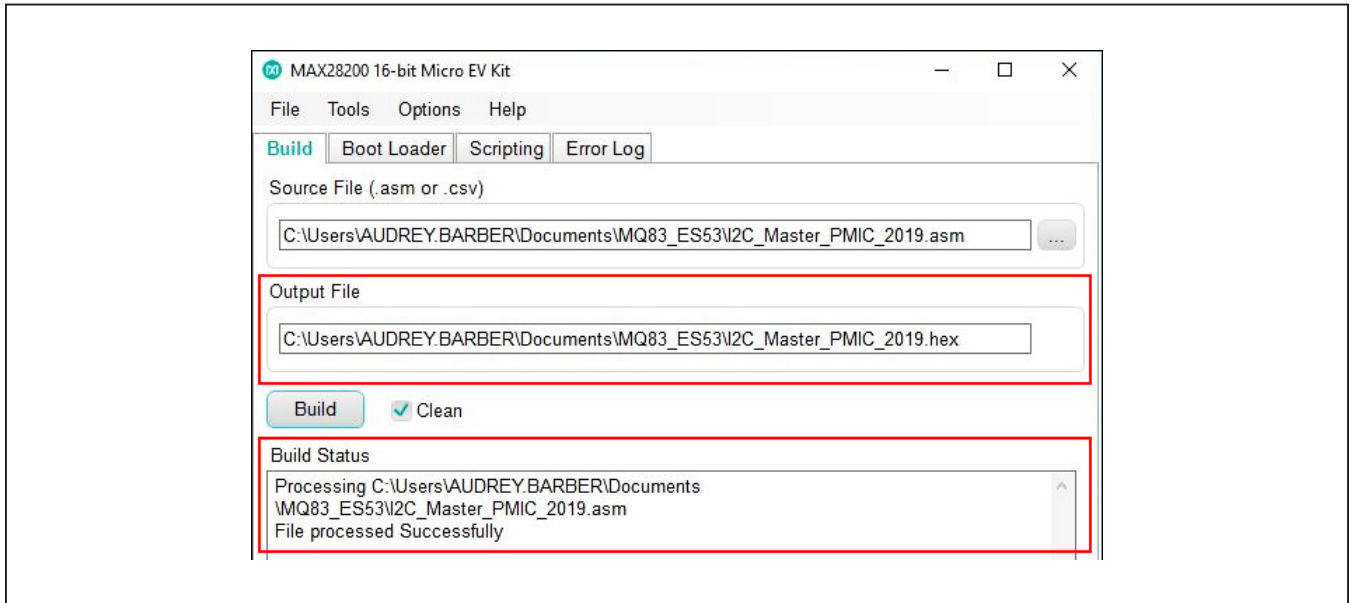

Figure 22. Successful Conversion of a .csv File into .hex File

- 6) Go to the **Boot Loader** tab, and under the **File** menu, select **Open Intel Hex File**. Choose the .hex file that was created from the original .csv file.
- 7) The data pattern appears (Figure 24). Click the **Program/Verify** button to program the MAX28200.

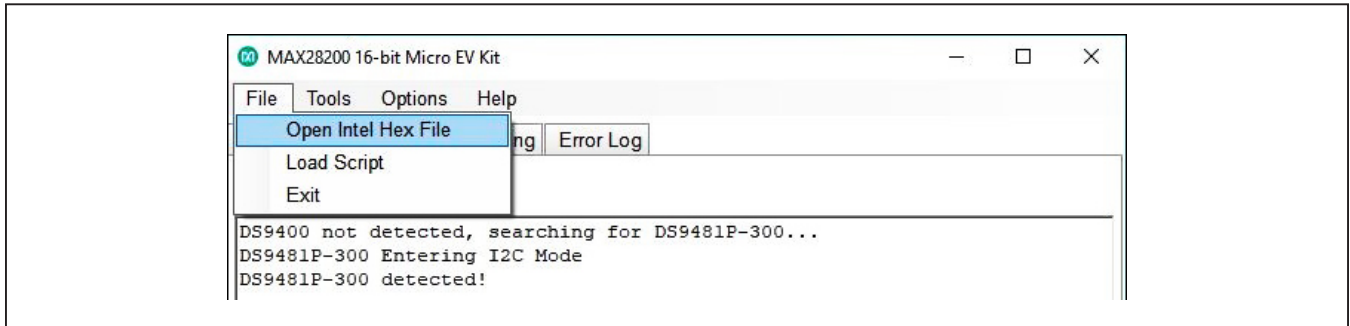

Figure 23. Programming the Device with the Selected Script

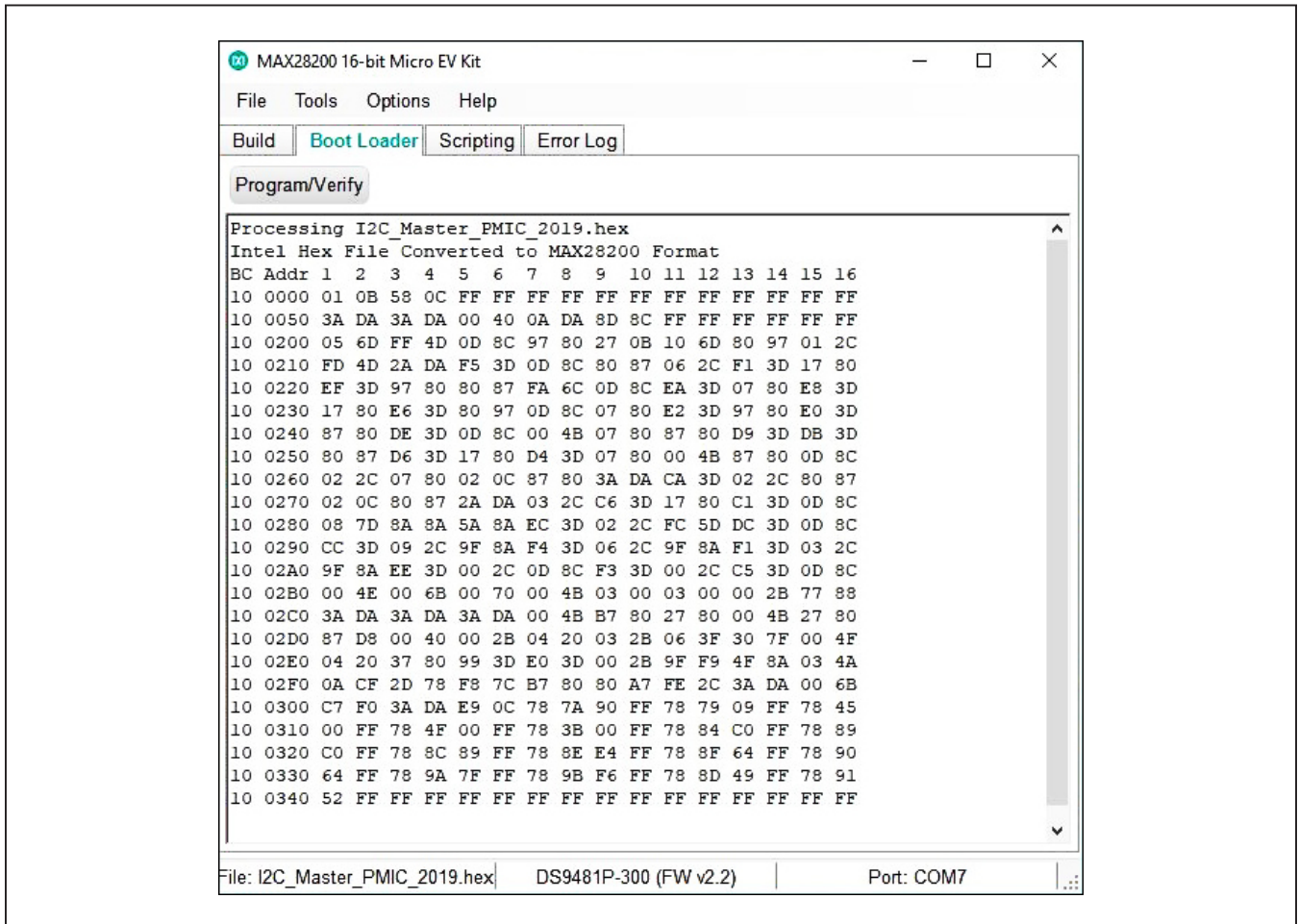

Figure 24. Programming the Device with the Data Pattern

8) If this operation is successful, **Programming Successful!** appears at the bottom of the log (Figure 25).

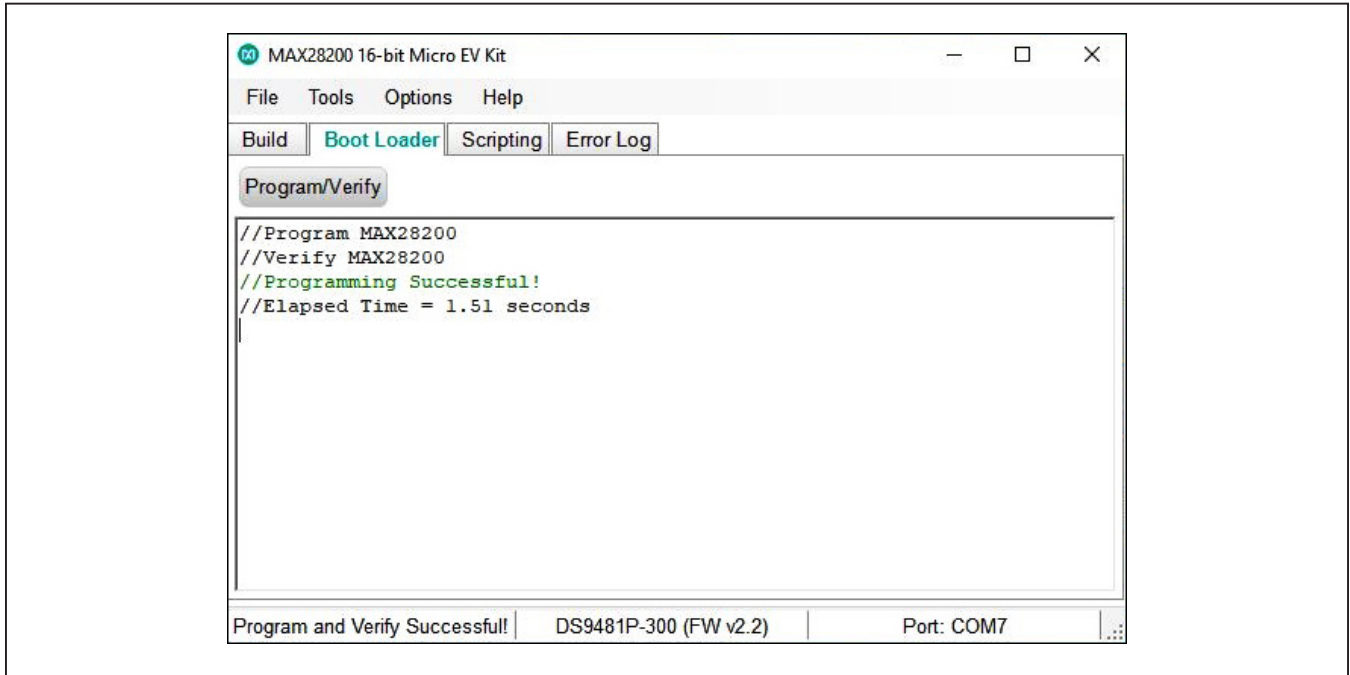

Figure 25. Device Successfully Programmed

**Table 1. Default Jumper Settings**

JUMPER	FUNCTION	SETTINGS	DESCRIPTION
JP1	RSTN SEL	1-2	Allows host bus adapter to assert a reset.
		2-3*	Allows DS9481P to assert a reset.
JP2	LED EN	1-2	PORT 0 LED enabled active low.
		3-4	PORT 1 LED enabled active low.
		5-6	PORT 2 LED enabled active low.
		7-8	PORT 3 LED enabled active low.
JP3	VDD EN	1-2*	Connects 3V3 power to DUT.
		2-3	Open to provide DUT current monitoring.
JP4	TEMP SENSE EN	1-2	Connects thermistor voltage-divider network to AIN1.
		Open*	Open to apply external signals through J5 SMA.
JP5	POT EN	1-2	Connects POT voltage-divider network to AIN0.
		Open*	Open to apply external signals through J4 SMA.
JP6	CMP_P	1-2*	Normal JTAG and GPIO functions available.
		Open	Pin 1 of header provides direct path to comparator P for high-impedance sources.
JP7	CMP_N	1-2*	Normal JTAG and GPIO functions available.
		Open	Pin 1 of header provides direct path to comparator N for high-impedance sources.

\*Default jumper settings

**Power Supply**

System power can be supplied by USB, the host bus adapter, or the DS9481P programming tool. Automatic source switching and voltage regulation is provided for the MAX28200.

**Programming**

A ROM-resident bootloader provides access to flash memory by way of JTAG or I<sup>2</sup>C. I<sup>2</sup>C communication is handled through connectors for a host bus adapter, the DS9481P programming tool, or direct header connection.

**JTAG/GPIO Mux**

The four GPIOs provided on the MAX28200 double as JTAG connections. Switch SW2 controls routing of the GPIOs. Closing SW2 enables JTAG mode, and opening SW2 enables GPIO mode.

**Status LEDs**

User-configurable status LEDs are provided for each GPIO. Jumpers provide an easy and positive way to deactivate LEDs when not needed.

**Comparator and ADC**

The comparator and 10-bit, dual-channel ADC are accessed through SMA connectors J4 and J5. An on-board NTC thermistor and potentiometer can also be connected to these analog inputs. Jumpers JP6 and JP7 provide an alternate path to the comparators for high-impedance signals. Install shunts for normal GPIO operation.

**Ordering Information**

PART	TYPE
MAX28200WEVKIT#	EV Kit

#Denotes RoHS compliance.



MAX28200 EV Kit Bill of Materials

QUANTITY	PART REFERENCE	VALUE	BOM_DESCRIPTION	MANUFACTURER_PN	MANUFACTURER
11	C1,C2,C3,C9, C10,C14,C15,C16, C17,C18,C19	1µF	CAP CER 1µF 6.3V X5R 0402	GRM155R60J105KE19D	Murata
1	C4	100nF	CAP CER 0.1µF 16V 10% X7R 0402	GRM155R71C104KA88D	Murata Electronics
2	C5,C6	1nF	CAP CER 1nF 50V 5% NP0 0603	GRM1885C1H102JA01D	Murata
2	C7,C8	470nF	CAP CER 0.47µF 10V 10% X5R 0402	GRM155R61A474KE15J	Murata Electronics North America
2	C11,C12	4.7µF	CAP CER 4.7µF 10V 10% X5R 0603	C0603C475K8PACTU	Kemet
1	C13	10nF	CAP CER 10000PF 16V 10% X7R 0402	GRM155R71C103KA01D	Murata Electronics North America
1	C20	10nF	CAP CER 10nF 25V 10% X7R 0603	GRM188R71E103KA01D	Murata
3	D1,D2,D3	DFLS240-7	DIODE SCHOTTKY 40V 2A POWERDI12	DFLS240-7	Diodes Inc
2	D4,D6	RED	LED SMARTLED RED 633NM 0603	LS L296-P2Q2-1-Z	OSRAM Opto Semiconductors Inc
2	D5,D7	GRN	LED SMARTLED GREEN 570NM 0603	LG L29K-G2J1-24-Z	OSRAM Opto Semiconductors Inc
1	D8	SML-LX0404SIUPGUSB	LED RGB CLEAR 0404 SMD	SML-LX0404SIUPGUSB	Lumex Opto/Components Inc.
4	H1,H2,H3,H4	DNI	DNI MTG 125DRL 300PAD		
1	J1	MICRO USB B R/A	CONN RCPT 5POS MICRO USB B R/A	47346-0001	Molex
1	J2	HOST I2C SPI	HOST I2C SPI 10P HEADER	5104338-1	TE Connectivity
1	J3	6P 1x6 RA	CONN HEADER .100" SNGL R/A 6POS	PRPC006SBCN-M71RC	Sullins
2	J4,J5	SMA	CONN SMA JACK STR 50 OHM PCB	5-1814832-1	TE Connectivity
1	J6	MAXDAP	MAXDAP_POGO_PIN CBL PLUG-OF-NAI LS 10-PIN	TC2050-IDC-NL	Tag-Connect LLC
1	JH1	JTAG MAXQ	CONN HEADER LOPRO STR 10POS GOLD	5104338-1	TE Connectivity
1	JH2	12P 2x6	CONN HEADER .100 DUAL STR 12POS	PEC06DAAN	Sullins
1	JP1	3P JUMPER	CONN HEADER .100 SINGL STR 3POS	PEC03SAAN	Sullins
1	JP2	8P 2x4	CONN HEADER .100 DUAL STR 8POS	PEC04DAAN	Sullins
5	JP3,JP4,JP5, JP6,JP7	JUMPER	CONN HEADER .100 SINGL STR 2POS (2x1)	PEC02SAAN	Sullins
1	L1	BLM41PG102SN1L	FERRITE CHIP 1KΩ 1500MA 1806	BLM41PG102SN1L	Murata Electronics
1	PCB1	PCB			
7	R1,R2,R3,R4, R11,R14,R15	10K	RES SMD 10KΩ 1% 1/16W 0402	RC0402FR-0710KL	Yageo
4	R5,R6,R9,R10	330	RES SMD 330Ω 1% 1/10W 0603	ERJ-3EKF3300V	Panasonic
2	R7,R8	1K	RES 1KΩ 1/10W 1% 0603 SMD	ERJ-3EKF1001V	Panasonic
1	R12	10K	TRIMMER 10KΩ 0.5W PC PIN	3386P-1-103LF	Bourns Inc.
1	R13	10K	NTC THERMISTOR 10KΩ 1% 0402	NCP15XH103F03RC	Murata Electronics North America
1	R16	2.7K	RES SMD 2.7KΩ 1% 1/10W 0402	ERJ-2RKF2701X	Panasonic
1	R17	1.4K	RES SMD 1.4KΩ 1% 1/10W 0402	ERJ-2RKF1401X	Panasonic Electronic Components
1	R18	1K	RES 1K OHM 1/10W 1% 0402 SMD	ERJ-2RKF1001X	Panasonic
1	SW1	B3S-1002 BY OMZ	SWITCH TACTILE SPST-NO 0.05A 24V	B3S-1002 BY OMZ	Omron Electronics
1	SW2	DIP SW 1POS	SWITCH AUTODIP 1POS TOP ACT 24V	A6T-1104	Omron Electronics
1	SW3	B3U-1000P	SWITCH TACTILE SPST-NO 0.05A 12V	B3U-1000P	Omron Electronics
1	TP1	WHT	TEST POINT PC MULTI PURPOSE WHT	5012	Keystone Electronics
1	TP2	BLK	TEST POINT PC MULTI PURPOSE BLK	5011	Keystone Electronics
1	U1	MAX28200EWC+T	MAX28200EWC+T 12P_WLP	MAX28200EWC+T	Maxim Integrated
1	U2	MAX13202EALT+T	ESD PROTECT 2CH 6-UDFN	MAX13202EALT+	Maxim Integrated
1	U3	MAX4674EUE+T	IC MULTIPLEXER QUAD 2X1 16TSSOP	MAX4674EUE+T	Maxim Integrated
1	U4	MAX8841ELT18+T	IC REG LINEAR 1.8V 150MA 6UDFN	MAX8841ELT18+T	Maxim Integrated
1	U5	MAX32625ITK+	MAX32625ITK+ 68P TQFN	MAX32625ITK+	Maxim Integrated
1	U6	MAX38902AATA+	IC REG LDO LINEAR ADJ. 5A 8TDFN	MAX38902AATA+	Maxim Integrated
1	U7	MAX8841ELT33+T	IC REG LINEAR 3.3V 150MA 6UDFN	MAX8841ELT33+T	Maxim Integrated
1	Y1	32.768KHz	CRYSTAL 32.768KHZ 6PF SMD	ECS-.327-6-12-TR	ECS Inc.

MAX28200EWC+T EV Kit—Block Diagram

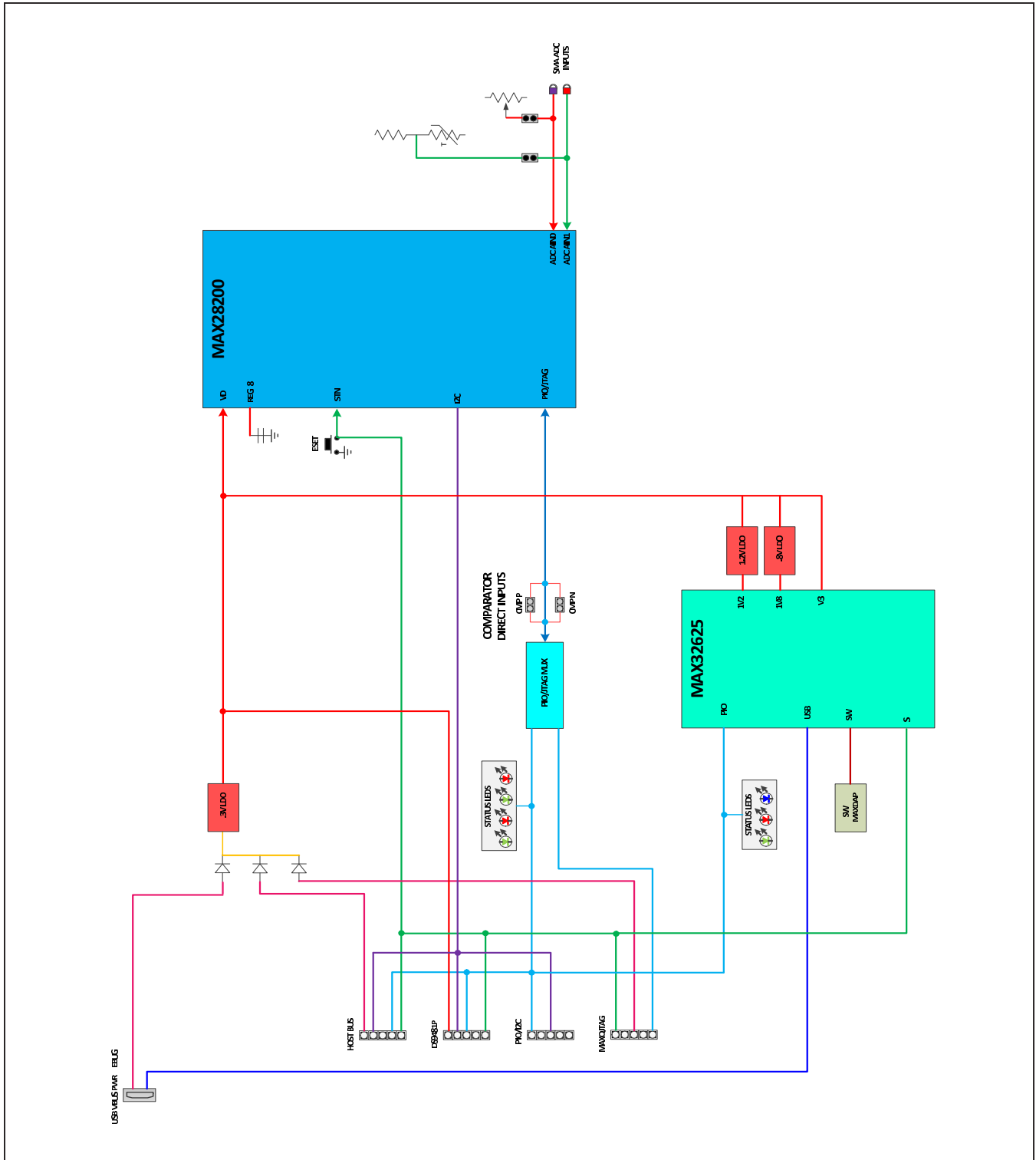

MAX28200EWC+T EV KIT—DUT, PWR, JTAG, Host Bus and IO

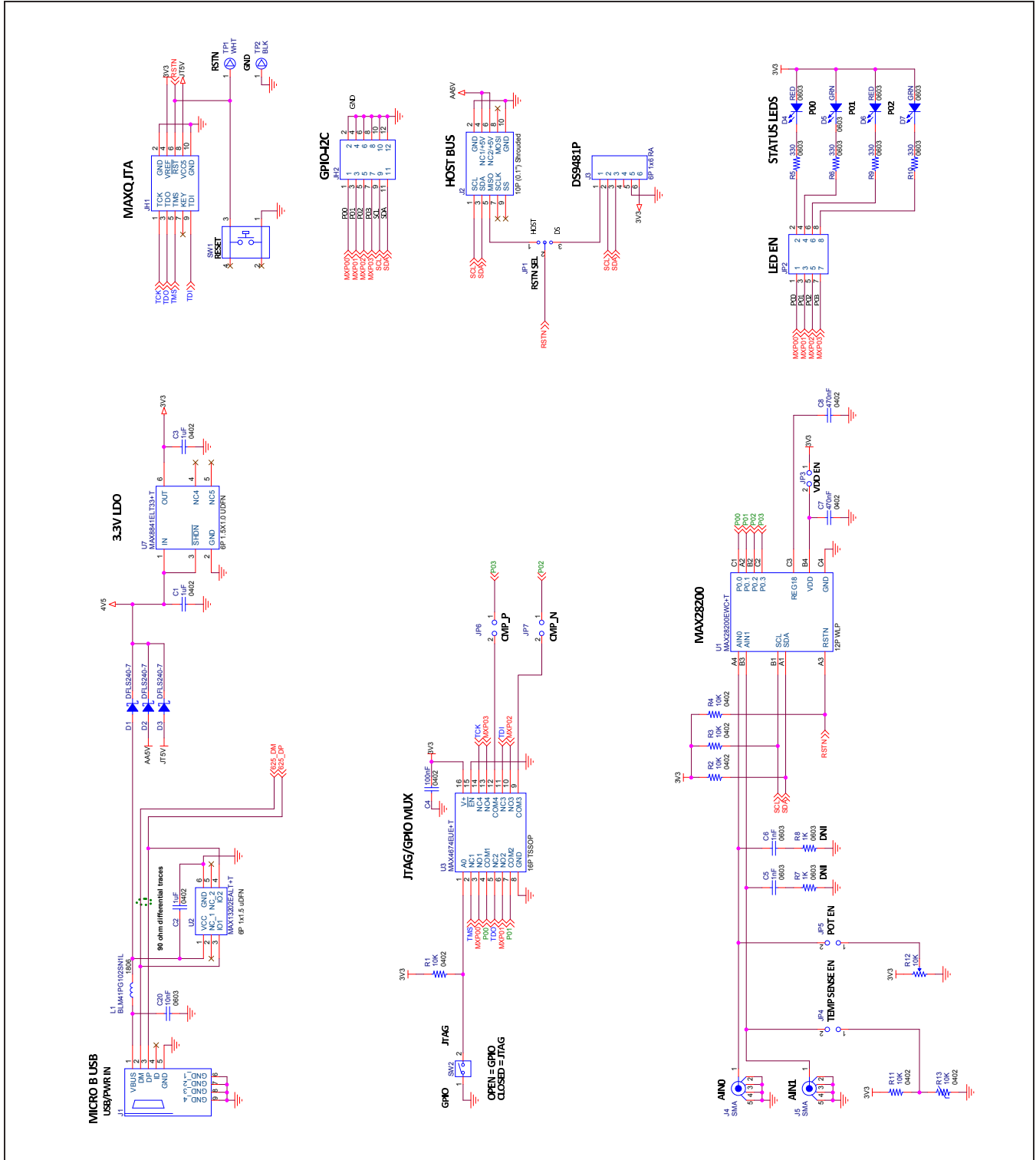

MAX28200EWC+T EV Kit—Block Diagram

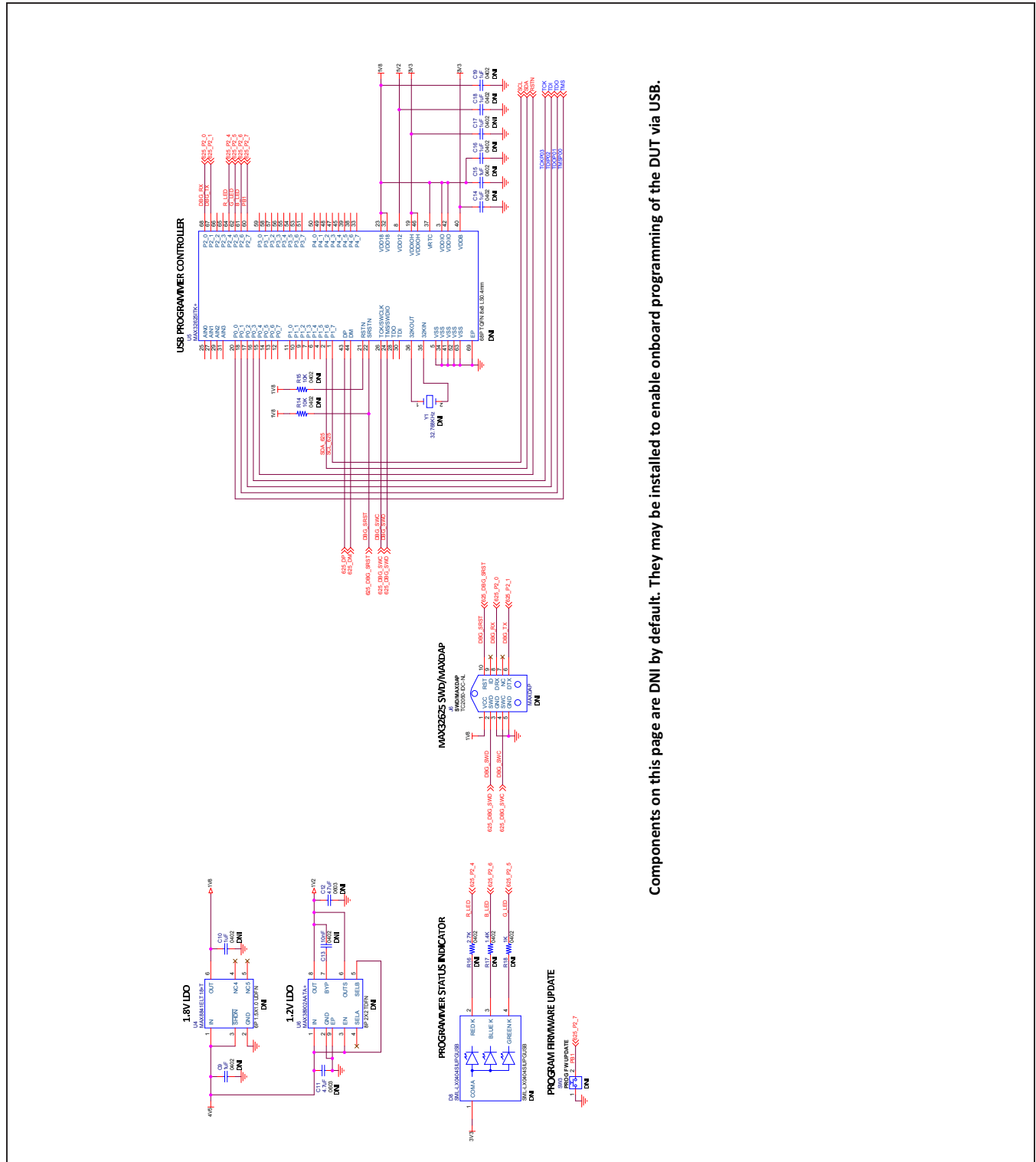

Components on this page are DNI by default. They may be installed to enable on-board programming of the DUT via USB.