

8th-Order, Lowpass, Switched-Capacitor Filters

General Description

The MAX291/MAX292/MAX295/MAX296 are easy-to-use, 8th-order, lowpass, switched-capacitor filters that can be set up with corner frequencies from 0.1Hz to 25kHz (MAX291/MAX292) or 0.1Hz to 50kHz (MAX295/MAX296).

The MAX291/MAX295 Butterworth filters provide maximally flat passband response, and the MAX292/MAX296 Bessel filters provide low overshoot and fast settling. All four filters have fixed responses, so the design task is limited to selecting the clock frequency that controls the filter's corner frequency.

An external capacitor is used to generate a clock using the internal oscillator, or an external clock signal can be used. An uncommitted operational amplifier (noninverting input grounded) is provided for building a continuous-time lowpass filter for post-filtering or anti-aliasing.

Produced in an 8-pin DIP/SO and a 16-pin wide SO package, and requiring a minimum of external components, the MAX291 series delivers very aggressive performance from a tiny area.

Applications

ADC Anti-Aliasing Filter
 Noise Analysis
 DAC Post-Filtering
 50Hz/60Hz Line-Noise Filtering

Typical Operating Circuit

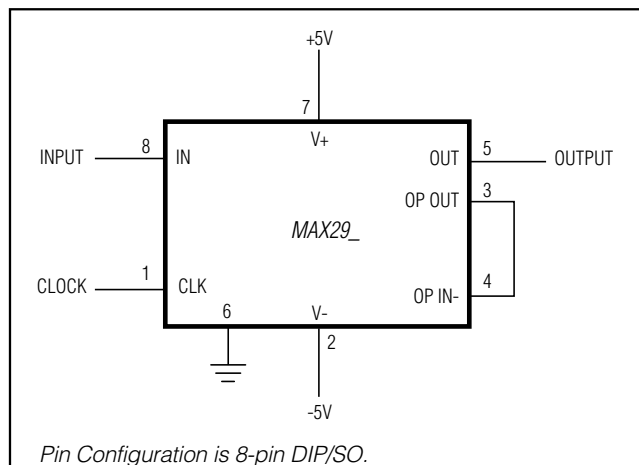

Features

- ◆ **8th-Order Lowpass Filters:**
Butterworth (MAX291/MAX295)
Bessel (MAX292/MAX296)
- ◆ **Clock-Tunable Corner-Frequency Range:**
0.1Hz to 25kHz (MAX291/MAX292)
0.1Hz to 50kHz (MAX295/MAX296)
- ◆ **No External Resistors or Capacitors Required**
- ◆ **Internal or External Clock**
- ◆ **Clock to Corner Frequency Ratio:**
100:1 (MAX291/MAX292)
50:1 (MAX295/MAX296)
- ◆ **Low Noise: -70dB THD + Noise (Typ)**
- ◆ **Operate with a Single +5V Supply or Dual ±5V Supplies**
- ◆ **Uncommitted Op Amp for Anti-Aliasing or Clock-Noise Filtering**
- ◆ **8-Pin DIP and SO Packages**

Ordering Information

| PART | TEMP. RANGE | PIN-PACKAGE |
|-----------|-----------------|---------------|
| MAX291CPA | 0°C to +70°C | 8 Plastic DIP |
| MAX291CSA | 0°C to +70°C | 8 SO |
| MAX291CWE | 0°C to +70°C | 16 Wide SO |
| MAX291C/D | 0°C to +70°C | Dice* |
| MAX291EPA | -40°C to +85°C | 8 Plastic DIP |
| MAX291ESA | -40°C to +85°C | 8 SO |
| MAX291EWE | -40°C to +85°C | 16 Wide SO |
| MAX291MJA | -55°C to +125°C | 8 CERDIP** |

Ordering Information continued at end of data sheet.

* Contact factory for dice specifications.

** Contact factory for availability and processing to MIL-STD-883.

Pin Configurations

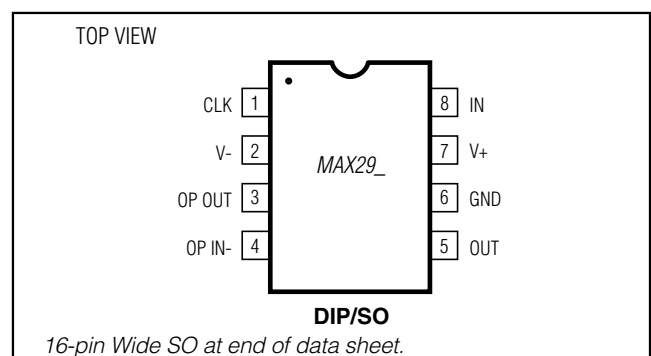

MAX291/MAX292/MAX295/MAX296

8th-Order, Lowpass, Switched-Capacitor Filters

ABSOLUTE MAXIMUM RATINGS

Supply Voltage (V+ to V-).....12V
 Input Voltage at Any Pin..... $V- + (-0.3V) \leq V_{IN} \leq V+ + (0.3V)$
 Continuous Power Dissipation
 8-Pin Plastic DIP (derate 9.09mW/°C above +70°C) ...727mW
 8-Pin SO (derate 5.88mW/°C above +70°C).....471mW
 16-Pin Wide SO (derate 9.52mW/°C above +70°C)762mW
 8-Pin CERDIP (derate 8.00mW/°C above +70°C).....640mW

Operating Temperature Ranges

MAX29_C0°C to +70°C
 MAX29_E-40°C to +85°C
 MAX29_MJA-55°C to +125°C
 Storage Temperature Range-65°C to +160°C
 Lead Temperature (soldering, 10s)+300°C
 Soldering Temperature (reflow)+240°C

Stresses beyond those listed under "Absolute Maximum Ratings" may cause permanent damage to the device. These are stress ratings only, and functional operation of the device at these or any other conditions beyond those indicated in the operational sections of the specifications is not implied. Exposure to absolute maximum rating conditions for extended periods may affect device reliability.

ELECTRICAL CHARACTERISTICS

(V+ = 5V, V- = -5V, filter output measured at OUT pin, 20kΩ load resistor to ground at OUT and OP OUT, f_{CLK} = 100kHz (MAX291/MAX292) or f_{CLK} = 50kHz (MAX295/MAX296), T_A = T_{MIN} to T_{MAX}, unless otherwise noted.)

| PARAMETER | CONDITIONS | | MIN | TYP | MAX | UNITS |
|------------------------------------|---------------|---------------------------------------|---------|-------|-------|--------|
| FILTER CHARACTERISTICS | | | | | | |
| Corner-Frequency Range | MAX291/MAX292 | | 0.1-25k | | | Hz |
| | MAX295/MAX296 | | 0.1-50k | | | |
| Clock to Corner Frequency Ratio | MAX291/MAX292 | | 100:1 | | | |
| | MAX295/MAX296 | | 50:1 | | | |
| Clock to Corner Frequency Tempco | MAX291 | | 10 | | | ppm/°C |
| | MAX292 | | 40 | | | |
| | MAX295 | | 5 | | | |
| | MAX296 | | 60 | | | |
| Insertion Gain Relative to DC Gain | MAX291 | f _{IN} = 0.50 F _O | -0.02 | -0.1 | | dB |
| | | f _{IN} = 1.00 F _O | -2.2 | -2.7 | -3.2 | |
| | | f _{IN} = 2.00 F _O | -43.0 | -48.0 | | |
| | | f _{IN} = 3.00 F _O | -70.0 | -76.0 | | |
| | MAX292 | f _{IN} = 0.25 F _O | -0.1 | -0.2 | -0.3 | |
| | | f _{IN} = 0.50 F _O | -0.6 | -0.8 | -1.0 | |
| | | f _{IN} = 1.00 F _O | -2.7 | -3.0 | -3.3 | |
| | | f _{IN} = 2.00 F _O | -11.0 | -13.0 | -15.0 | |
| | | f _{IN} = 3.00 F _O | -30.0 | -34.0 | | |
| | | f _{IN} = 4.00 F _O | -47.0 | -51.0 | | |
| | MAX295 | f _{IN} = 0.50 F _O | -0.02 | -0.1 | | |
| | | f _{IN} = 1.00 F _O | -2.2 | -2.7 | -3.2 | |
| | | f _{IN} = 2.00 F _O | -43.0 | -48.0 | | |
| | | f _{IN} = 3.00 F _O | -70.0 | -76.0 | | |
| | MAX296 | f _{IN} = 0.25 F _O | -0.1 | -0.2 | -0.3 | |
| | | f _{IN} = 0.50 F _O | -0.6 | -0.8 | -1.0 | |
| | | f _{IN} = 1.00 F _O | -2.7 | -3.0 | -3.3 | |
| | | f _{IN} = 2.00 F _O | -11.0 | -13.0 | -15.0 | |
| | | f _{IN} = 3.00 F _O | -30.0 | -34.0 | | |
| | | f _{IN} = 4.00 F _O | -47.0 | -51.0 | | |
| | | f _{IN} = 6.00 F _O | -74.0 | -78.0 | | |

MAX291/MAX292/MAX295/MAX296

8th-Order, Lowpass, Switched-Capacitor Filters

ELECTRICAL CHARACTERISTICS (continued)

(V+ = 5V, V- = -5V, filter output measured at OUT pin, 20kΩ load resistor to ground at OUT and OP OUT, f_{CLK} = 100kHz (MAX291/MAX292) or f_{CLK} = 50kHz (MAX295/MAX296), T_A = T_{MIN} to T_{MAX}, unless otherwise noted.)

| PARAMETER | CONDITIONS | MIN | TYP | MAX | UNITS |
|--|---|--------|------|--------|-------|
| Output DC Swing | | ±4 | | | V |
| Output Offset Voltage | IN = GND | | ±150 | ±400 | mV |
| DC Insertion Gain Error with Output Offset Removed | | 0.15 | 0 | -0.15 | dB |
| Total Harmonic Distortion plus Noise | T _A = +25°C, f _{CLK} = 100kHz | | -70 | | dB |
| Clock Feedthrough | f _{CLK} = 100kHz | | 6 | | mVp-p |
| CLOCK | | | | | |
| Internal Oscillator Frequency | C _{OSC} = 1000pF | 29 | 35 | 43 | kHz |
| Internal Oscillator Current Source/Sink | V _{CLK} = 0V or 5V | | ±70 | ±120 | μA |
| Clock Input High (Note 1) | | 4.0 | | | V |
| Low | | | | 1.0 | V |
| UNCOMMITTED OP AMP | | | | | |
| Input Offset Voltage | | | ±10 | ±50 | mV |
| Output DC Swing | | ±4 | | | V |
| Input Bias Current | | | 0.05 | | μA |
| POWER REQUIREMENTS | | | | | |
| Supply Voltage Dual Supply | | ±2.375 | | ±5.500 | V |
| Single Supply | V- = 0V, GND = V±2 | 4.750 | | 11.000 | V |
| Supply Current | V+ = 5V, V- = -5V, V _{CLK} = 0V to 5V | | 15 | 22 | mA |
| | V+ = 2.375V, V- = -2.375V, V _{CLK} = -2V to 2V | | 7 | 12 | |

Note 1. Guaranteed by design.

Typical Operating Characteristics

(V+ = 5V, V- = -5V, T_A = +25°C, f_{CLK} = 100kHz (MAX291/MAX292) or f_{CLK} = 50kHz (MAX295/MAX296), unless otherwise noted.)

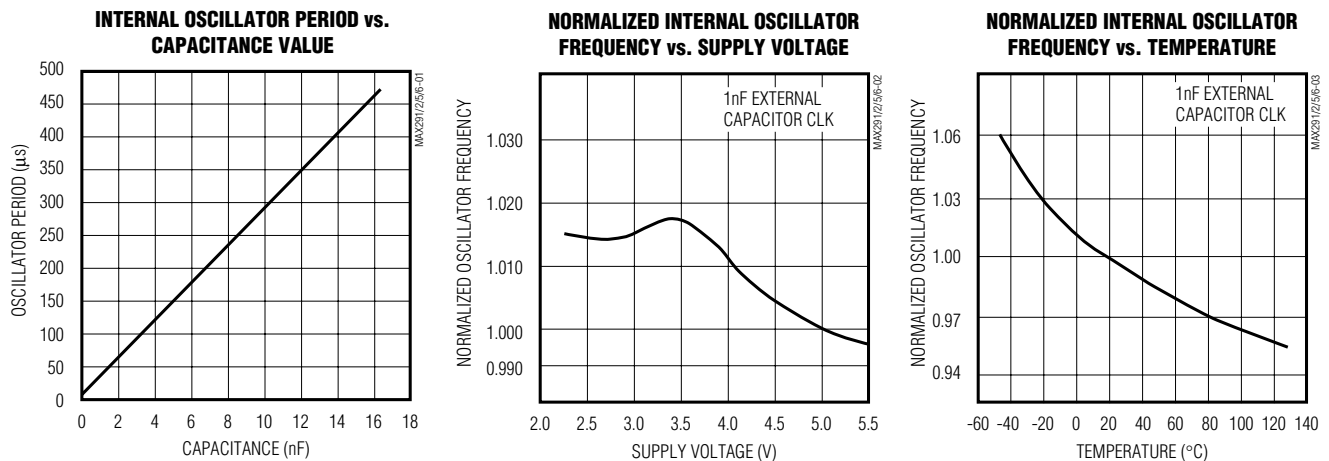

MAX291/MAX292/MAX295/MAX296

8th-Order, Lowpass, Switched-Capacitor Filters

Typical Operating Characteristics (continued)

($V_+ = 5V$, $V_- = -5V$, $T_A = +25^\circ C$, $f_{CLK} = 100kHz$ (MAX291/MAX292) or $f_{CLK} = 50kHz$ (MAX295/MAX296), unless otherwise noted.)

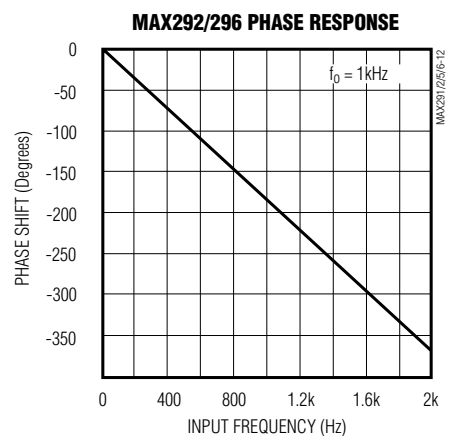
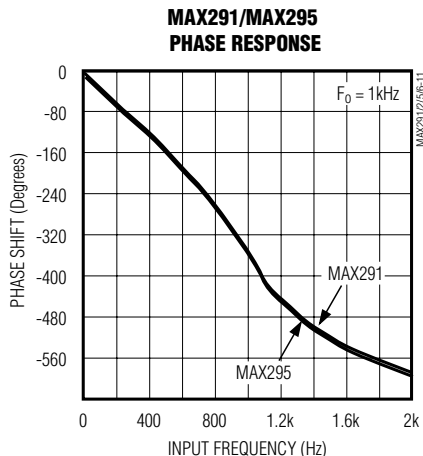
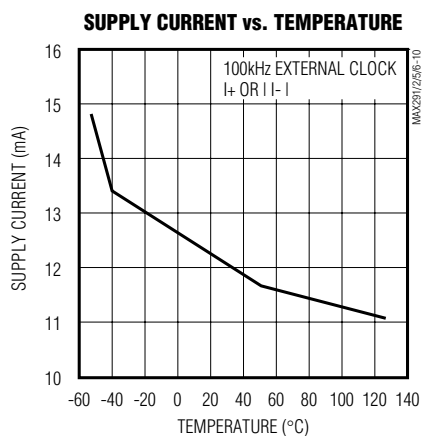
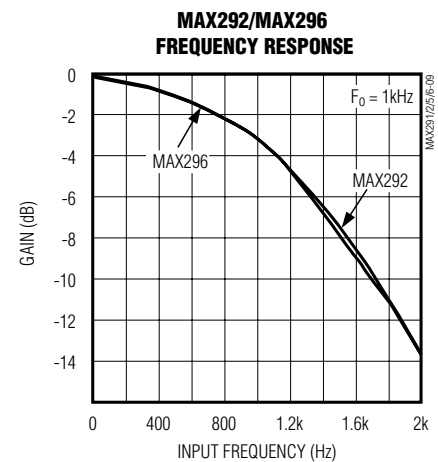
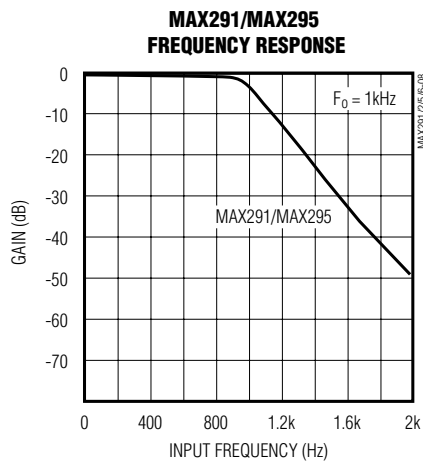
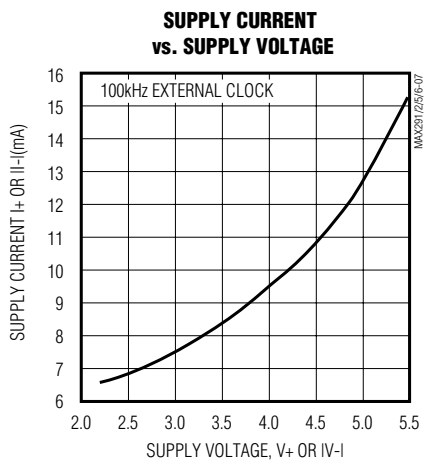
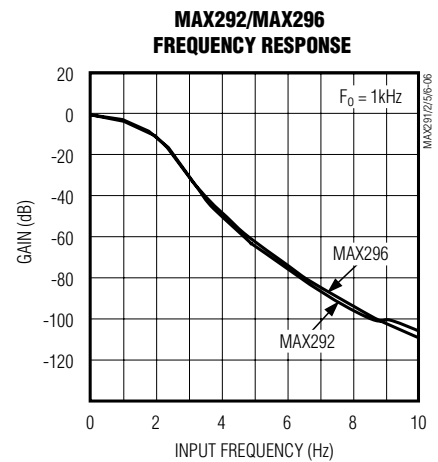
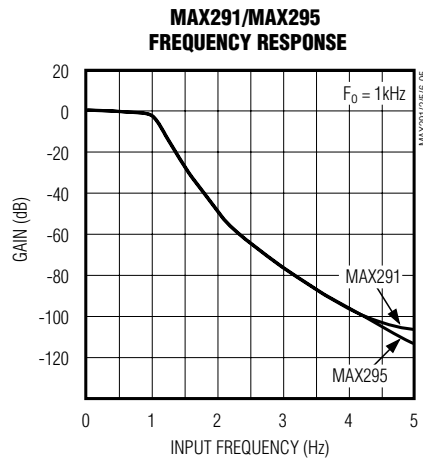
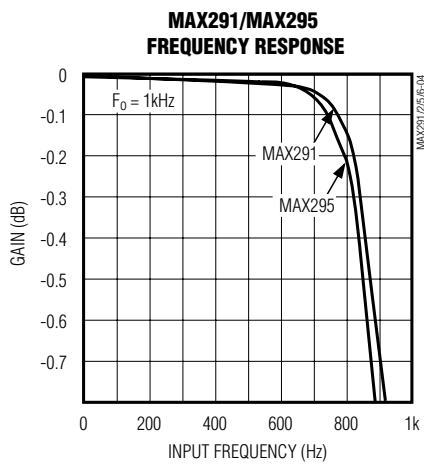

MAX291/MAX292/MAX295/MAX296

8th-Order, Lowpass, Switched-Capacitor Filters

Typical Operating Characteristics (continued)

($V_+ = 5V$, $V_- = -5V$, $R_{LOAD} = 5k\Omega$, $T_A = +25^\circ C$, unless otherwise noted.)

MAX296 LOW-VOLTAGE FREQUENCY RESPONSE

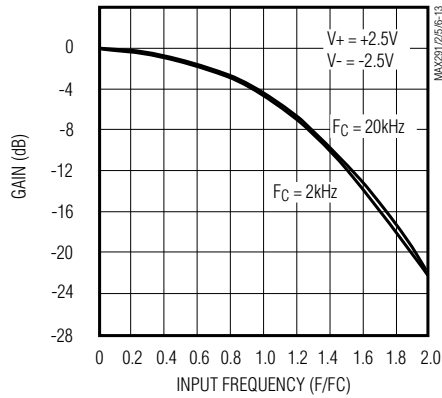

MAX291 LOW-VOLTAGE FREQUENCY RESPONSE

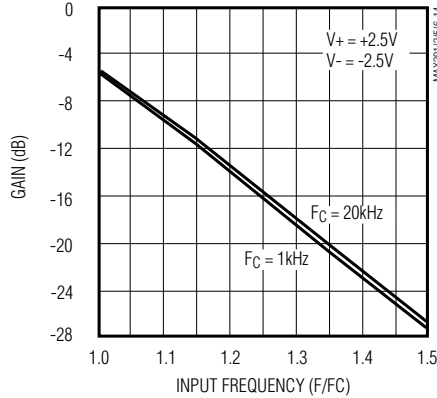

MAX291 THD + NOISE vs. INPUT SIGNAL AMPLITUDE

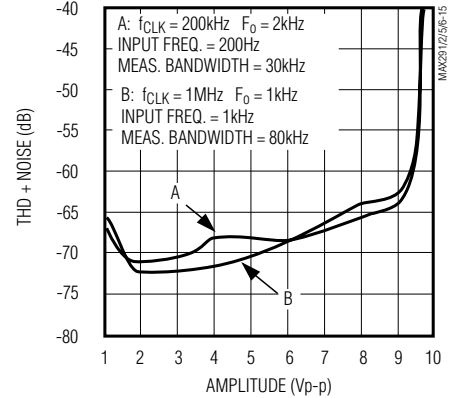

MAX296 LOW-VOLTAGE PHASE RESPONSE

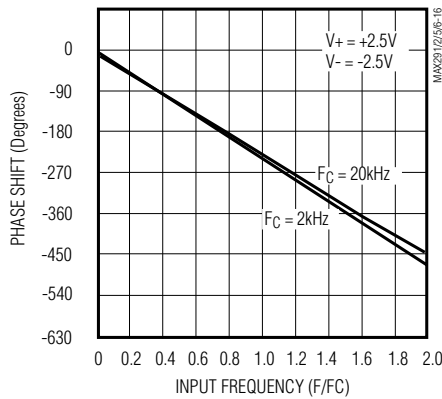

MAX291 LOW-FREQUENCY PHASE RESPONSE

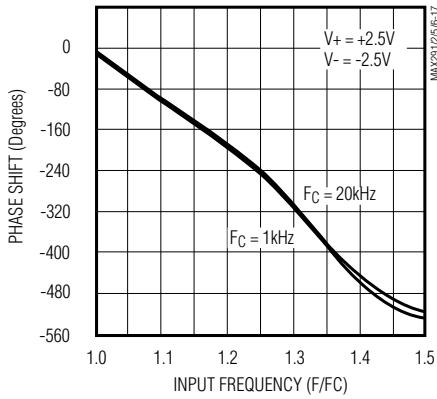

MAX292 THD + NOISE vs. INPUT SIGNAL AMPLITUDE

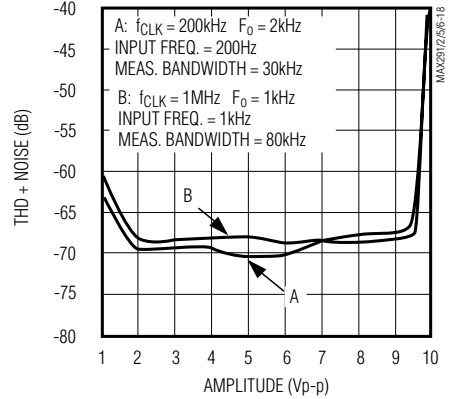

MAX295 THD + NOISE vs. INPUT SIGNAL AMPLITUDE

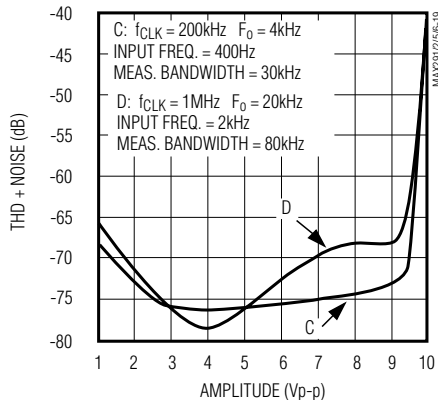

MAX296 THD + NOISE vs. INPUT SIGNAL AMPLITUDE

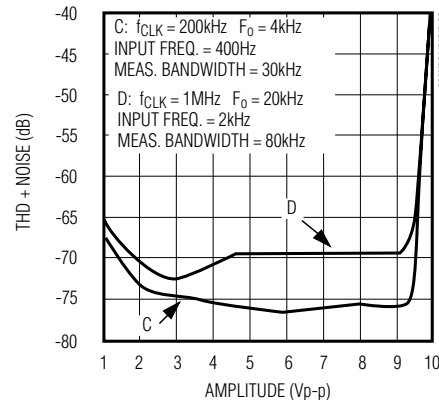

MAX291/MAX292/MAX295/MAX296

8th-Order, Lowpass, Switched-Capacitor Filters

Pin Description

| 8-PIN | 16-PIN | NAME | FUNCTION |
|-------|---------------------------|--------|--|
| | 1, 2, 7, 8, 9, 10, 15, 16 | N.C. | No Connect |
| 1 | 3 | CLK | Clock Input. Use internal or external clock. |
| 2 | 4 | V- | Negative Supply pin. Dual supplies: -2.375V to -5.500V. Single supplies: V- = 0V. |
| 3 | 5 | OP OUT | Uncommitted Op-Amp Output |
| 4 | 6 | OP IN- | Inverting Input to the uncommitted op amp. The noninverting op amp is internally tied to ground. |
| 5 | 11 | OUT | Filter Output |
| 6 | 12 | GND | Ground. In single-supply operation, GND must be biased to the mid-supply voltage level. |
| 7 | 13 | V+ | Positive Supply pin. Dual supplies: +2.375V to +5.500V. Single supplies: +4.75V to +11.0V. |
| 8 | 14 | IN | Filter Input |

Detailed Description

Lowpass Butterworth filters such as the MAX291/MAX295 provide maximally flat passband response, making them ideal for instrumentation applications that require minimum deviation from the DC gain throughout the passband.

Lowpass Bessel filters such as the MAX292/MAX296 delay all frequency components equally, preserving the shape of step inputs, subject to the attenuation of the higher frequencies. They also settle faster than Butterworth filters. Faster settling can be important in applications that use a multiplexer (mux) to select one signal to be sent to an analog-to-digital converter (ADC)—an anti-aliasing filter placed between the mux and the ADC must settle quickly after a new channel is selected by the mux.

The difference in the filters' responses can be observed when a 3kHz square wave is applied to the filter input (Figure 1, trace A). With the filter cutoff frequencies set at 10kHz, trace C shows the MAX291/MAX295 Butterworth filter response and trace B shows the MAX292/MAX296 Bessel filter response. Since the MAX292/MAX296 have a linear phase response in the passband, all frequency components are delayed equally, which preserves the square wave. The filters attenuate higher frequencies of the input square wave, giving rise to the rounded edges at the output. The MAX291/MAX295 delay different frequency components by varying times, causing the overshoot and ringing shown in trace C.

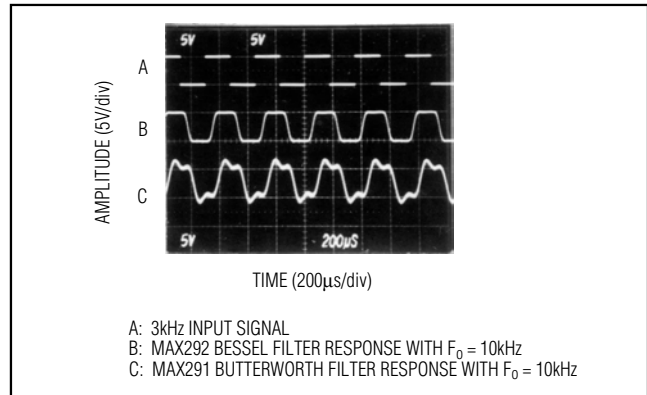

Figure 1. Bessel vs. Butterworth Filter Responses

The MAX291/MAX295 give more attenuation outside the passband. The phase and frequency response curves in the *Typical Operating Characteristics* reveal the differences between the two types of filters.

MAX291/MAX292/MAX295/MAX296 phase shift and gain do not vary significantly from part to part. Typical phase shift and gain differences are less than 0.5% at the corner frequency (F_c).

Corner Frequency and Filter Attenuation

The MAX291/MAX292 operate with a 100:1 clock to corner frequency ratio and a 25kHz maximum corner frequency, where corner frequency is defined as the point where the filter output is 3dB below the filter's DC gain. The MAX295/MAX296 operate with a 50:1 clock to corner frequency ratio with a 50kHz maximum corner frequency. The 8 poles provide 48dB of attenuation per octave.

Background Information

Most switched-capacitor filters are designed with biquadratic sections. Each section implements two filtering poles, and the sections can be cascaded to produce higher-order filters. The advantage to this approach is ease of design. However, this type of design can display poor sensitivity if any section's Q is high.

An alternative approach is to emulate a passive network using switched-capacitor integrators with summing and scaling. The passive network can be synthesized using CAD programs, or can be found in many filter books. Figure 2 shows the basic ladder filter structure.

A switched-capacitor filter that emulates a passive ladder filter retains many of its advantages. The filter's component sensitivity is low when compared to a cascaded biquad design because each component affects the entire filter shape, not just one pole pair. That is, a mismatched component in a biquad design will have a concentrated

MAX291/MAX292/MAX295/MAX296

8th-Order, Lowpass, Switched-Capacitor Filters

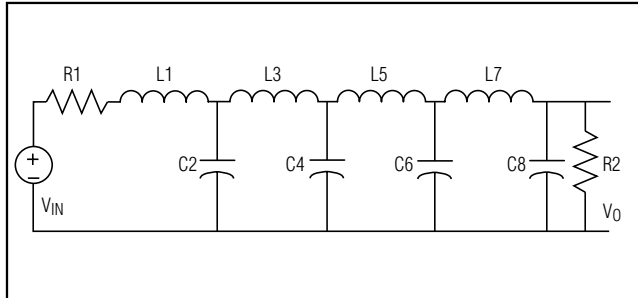

Figure 2. 8th-Order Ladder Filter Network

error on its respective poles, while the same mismatch in a ladder filter design will spread its error over all poles.

The MAX291/MAX292/MAX295/MAX296 input impedance is effectively that of a switched-capacitor resistor (see equation below, and Table 1), and it is inversely proportional to frequency. The input impedance values determined below represent average input impedance, since the input current is not continuous. The input current flows in a series of pulses that charge the input capacitor every time the appropriate switch is closed. A good rule of thumb is that the driver's input source resistance should be less than 10% of the filter's input impedance. The input impedance of the filter can be estimated using the following formula:

$$Z = 1 / (f_{CLK} * C)$$

where: f_{CLK} = Clock Frequency

The input impedance for various clock frequencies is given below:

Table 1. Input Impedance for Various Clock Frequencies

| PART | C (pF) | 10kHz (MΩ) | 100kHz (MΩ) | 1000kHz (kΩ) |
|--------|--------|------------|-------------|--------------|
| MAX291 | 2.24 | 44.6 | 4.46 | 446 |
| MAX292 | 3.28 | 30.5 | 3.05 | 305 |
| MAX295 | 4.47 | 22.4 | 2.24 | 224 |
| MAX296 | 4.22 | 23.7 | 2.37 | 237 |

Clock-Signal Requirements

The MAX291/MAX292/MAX295/MAX296 maximum recommended clock frequency is 2.5MHz, producing a cutoff frequency of 25kHz for the MAX291/MAX292 and 50kHz for the MAX295/MAX296. The CLK pin can be driven by an external clock or by the internal oscillator with an external capacitor. For external clock applications, the clock circuitry has been designed to interface with +5V CMOS logic. Drive the CLK pin with a CMOS gate powered from 0V and +5V when using either a single +5V supply or dual +5V supplies. The MAX291/MAX292/MAX295/MAX296 supply current increases slightly (<3%) with increasing

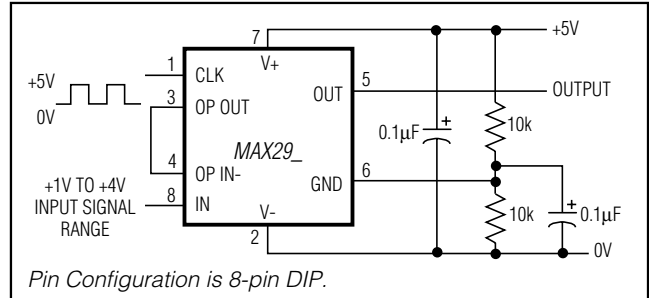

Figure 3. +5V Single-Supply Operation

clock frequency over the clock range 100kHz to 1MHz. Varying the rate of an external clock will dynamically adjust the corner frequency of the filter.

Ideally, the MAX291/MAX292/MAX295/MAX296 should be clocked symmetrically (50% duty cycle). MAX291/MAX292/MAX295/MAX296 can be operated with clock asymmetry of up to 60/40% (or 40/60%) if the clock remains HIGH and LOW for at least 200ns. For example, if the part has a maximum clock rate of 2.5MHz, then the clock should be high for at least 200ns, and low for at least 200ns.

When using the internal oscillator, the capacitance (C_{OSC}) from CLK to ground determines the oscillator frequency:

$$f_{OSC} \text{ (kHz)} \approx \frac{10^5}{3C_{OSC} \text{ (pF)}}$$

The stray capacitance at CLK should be minimized because it will affect the internal oscillator frequency.

Application Information

Power Supplies

The MAX291/MAX292/MAX295/MAX296 operate from either dual or single power supplies. The dual-supply voltage range is +2.375V to +5.500V. The ±2.5V dual supply is equivalent to single-supply operation (Figure 3). Minor performance degradation could occur due to the external resistor divider network, where the GND pin is biased to mid-supply.

Input Signal Range

The ideal input signal range is determined by observing at what voltage level the total harmonic distortion plus noise (THD + Noise) ratio is maximized for a given corner frequency. The *Typical Operating Characteristics* show the MAX291/MAX292/MAX295/MAX296 THD + Noise response as the input signal's peak-to-peak amplitude is varied.

Uncommitted Op Amp

The uncommitted op amp has its noninverting input tied to the GND pin, and can be used to build a 1st- or 2nd-

MAX291/MAX292/MAX295/MAX296

8th-Order, Lowpass, Switched-Capacitor Filters

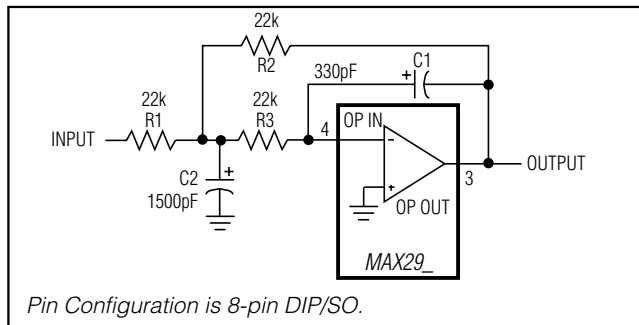

Figure 4. Uncommitted Op Amp Configured as a 2nd-Order Butterworth Lowpass Filter ($F_o = 10\text{kHz}$)

order continuous lowpass filter. This filter is convenient for anti-aliasing applications, or for clock noise attenuation at the switched-capacitor filter's output. Figure 4 shows a 2nd-order lowpass Butterworth filter built using the uncommitted op amp with a 10kHz corner frequency. This filter's input resistance of 22k satisfies the minimum load requirements of the switched-capacitor filter.

The uncommitted op amp (with a 2MHz gain bandwidth product) can alternatively be used at the input of the switched-capacitor filter to help reduce any possible clock ripple feedthrough to the output.

DAC Post-Filtering

When using the MAX291/MAX292/MAX295/MAX296 for DAC post-filtering, synchronize the DAC and the filter clocks. If clocks are not synchronized, beat frequencies will alias into the desired passband. The DAC's clock should be generated by dividing down the switched-capacitor filter's clock.

Harmonic Distortion

Harmonic distortion arises from nonlinearities within the filters. These nonlinearities generate harmonics when a pure sine wave is applied to the filter input. Table 2 lists typical harmonic distortion values for the MAX291/MAX292/MAX295/MAX296 with a 1kHz 5Vp-p sine-wave input signal, a 1MHz clock frequency, and a 5k Ω load.

Table 2. Typical Harmonic Distortion (dB)

| | | Harmonic | | | |
|--------|--------|----------|-----|-----|-----|
| | | 2nd | 3rd | 4th | 5th |
| Filter | MAX291 | -72 | -78 | -83 | -89 |
| | MAX292 | -71 | -82 | -82 | -88 |
| | MAX295 | -93 | -86 | -92 | -97 |
| | MAX296 | -71 | -89 | -96 | -96 |

Ordering Information (continued)

| PART | TEMP. RANGE | PIN-PACKAGE |
|-----------|-----------------|---------------|
| MAX292CPA | 0°C to +70°C | 8 Plastic DIP |
| MAX292CSA | 0°C to +70°C | 8 SO |
| MAX292CWE | 0°C to +70°C | 16 Wide SO |
| MAX292C/D | 0°C to +70°C | Dice* |
| MAX292EPA | -40°C to +85°C | 8 Plastic DIP |
| MAX292ESA | -40°C to +85°C | 8 SO |
| MAX292EWE | -40°C to +85°C | 16 Wide SO |
| MAX292MJA | -55°C to +125°C | 8 CERDIP** |
| MAX295CPA | 0°C to +70°C | 8 Plastic DIP |
| MAX295CSA | 0°C to +70°C | 8 SO |
| MAX295CWE | 0°C to +70°C | 16 Wide SO |
| MAX295C/D | 0°C to +70°C | Dice* |
| MAX295EPA | -40°C to +85°C | 8 Plastic DIP |
| MAX295ESA | -40°C to +85°C | 8 SO |
| MAX295EWE | -40°C to +85°C | 16 Wide SO |
| MAX295MJA | -55°C to +125°C | 8 CERDIP** |
| MAX296CPA | 0°C to +70°C | 8 Plastic DIP |
| MAX296CSA | 0°C to +70°C | 8 SO |
| MAX296CWE | 0°C to +70°C | 16 Wide SO |
| MAX296C/D | 0°C to +70°C | Dice* |
| MAX296EPA | -40°C to +85°C | 8 Plastic DIP |
| MAX296ESA | -40°C to +85°C | 8 SO |
| MAX296EWE | -40°C to +85°C | 16 Wide SO |
| MAX296MJA | -55°C to +125°C | 8 CERDIP** |

* Contact factory for dice specifications.

** Contact factory for availability and processing to MIL-STD-883.

MAX291/MAX292/MAX295/MAX296

8th-Order, Lowpass, Switched-Capacitor Filters

Pin Configurations (continued)

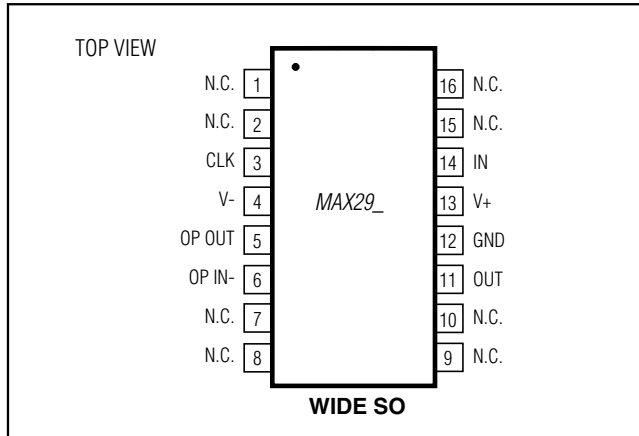

Package Information

For the latest package outline information and land patterns, go to www.maxim-ic.com/packages. Note that a "+", "#", or "-" in the package code indicates RoHS status only. Package drawings may show a different suffix character, but the drawing pertains to the package regardless of RoHS status.

| PACKAGE TYPE | PACKAGE CODE | DOCUMENT NO. |
|---------------|--------------|-------------------------|
| 8 CERDIP | J8-2 | 21-0045 |
| 8 Plastic DIP | P8-2 | 21-0043 |
| 8 SO | S8-5 | 21-0041 |
| 16 Wide SO | W16-1 | 21-0042 |