



[Evaluation Kit
Available](#)



[Design
Resources](#)



[Tools
and Models](#)



[Support](#)

Click [here](#) to ask an associate for production status of specific part numbers.

Ultra-Low Power, Single-Channel Integrated Biopotential (ECG, R-to-R Detection) AFE

MAX30003

General Description

The MAX30003 is a complete, biopotential, analog front-end solution for wearable applications. It offers high performance for clinical and fitness applications, with ultra-low power for long battery life. The MAX30003 is a single biopotential channel providing ECG waveforms and heart rate detection.

The biopotential channel has ESD protection, EMI filtering, internal lead biasing, DC leads-off detection, ultra-low power leads-on detection during standby mode, and extensive calibration voltages for built-in self-test. Soft power-up sequencing ensures no large transients are injected into the electrodes. The biopotential channel also has high input impedance, low noise, high CMRR, programmable gain, various low-pass and high-pass filter options, and a high resolution analog-to-digital converter. The biopotential channel is DC coupled, can handle large electrode voltage offsets, and has a fast recovery mode to quickly recover from overdrive conditions, such as defibrillation and electrosurgery.

The MAX30003 is available in a 28-pin TQFN and 30-bump wafer-level package (WLP), operating over the 0°C to +70°C commercial temperature range.

Applications

- Single-Lead Event Monitors for Arrhythmia Detection
- Single-Lead Wireless Patches for At-Home/ In-Hospital Monitoring
- Chest Band Heart Rate Monitors for Fitness Applications
- Bio Authentication and ECG-On-Demand Applications

[Ordering Information](#) appears at end of data sheet.

Benefits and Features

- Clinical-Grade ECG AFE with High-Resolution Data Converter
 - 15.5 Bits Effective Resolution with 5 μ V_{P-P} Noise
- Better Dry Starts Due to Much Improved Real World CMRR and High Input Impedance
 - Fully Differential Input Structure with CMRR > 100dB
- Offers Better Common-Mode to Differential Mode Conversion Due to High Input Impedance
 - High Input Impedance > 500M Ω for Extremely Low Common-to-Differential Mode Conversion
- Minimum Signal Attenuation at the Input During Dry Start Due to High Electrode Impedance
- High DC Offset Range of \pm 650mV (1.8V, typ) Allows to Be Used with Wide Variety of Electrodes
- High AC Dynamic Range of 65mV_{P-P} Will Help the AFE Not Saturate in the Presence of Motion/Direct Electrode Hits
- Longer Battery Life Compared to Competing Solutions
 - 85 μ W at 1.1V Supply Voltage
- Leads-On Interrupt Feature Allows to Keep μ C in Deep Sleep Mode with RTC Off Until Valid Lead Condition is Detected
 - Lead-On Detect Current: 0.7 μ A (typ)
- Built-In Heart Rate Detection with Interrupt Feature Eliminates the Need to Run HR Algorithm on the μ Controller
 - Robust R-R Detection in High Motion Environment at Extremely Low Power
- Configurable Interrupts Allows the μ C Wake-Up Only on Every Heart Beat Reducing the Overall System Power
- High Accuracy Allows for More Physiological Data Extractions
- 32-Word FIFO Allows You to Wake Up μ Controller Every 256ms with Full ECG Acquisition
- High-Speed SPI Interface
- Shutdown Current of 0.5 μ A (typ)

Functional Diagram

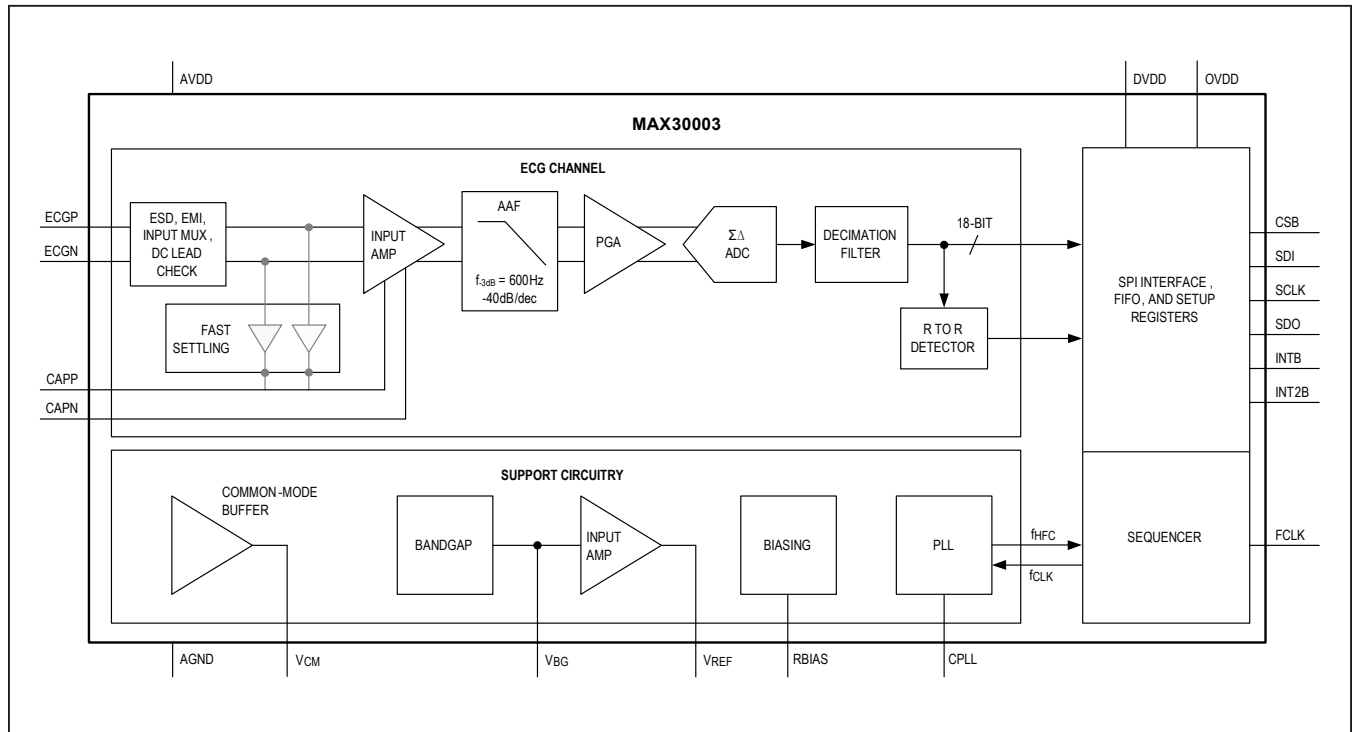

Absolute Maximum Ratings

AV_{DD} to AGND-0.3V to +2.0V
 DV_{DD} to DGND-0.3V to +2.0V
 AV_{DD} to DV_{DD}.....-0.3V to +0.3V
 OV_{DD} to DGND-0.3V to +3.6V
 AGND to DGND-0.3V to +0.3V
 CSB, SCLK, SDI, FCLK to DGND-0.3V to +3.6V
 SDO, INTB, INT2B to
 DGND-0.3V to the lower of (3.6V and OV_{DD} + 0.3V)
 All other pins to
 AGND-0.3V to the lower of (2.0V and AV_{DD} + 0.3V)
 Maximum Current into Any Pin..... ±50mA

Continuous Power Dissipation (T_A = +70°C)
 28-Pin TQFN (derate 34.5mW/°C above +70°C) ...2758.6mW
 30-Bump WLP (derate 24.3mW/°C
 above +70°C)1945.5mW
 Operating Temperature Range.....0°C to +70°C
 Junction Temperature.....+150°C
 Storage Temperature Range.....-65°C to +150°C
 Lead Temperature (Soldering, 10sec).....+300°C
 Soldering Temperature (reflow).....+260°C

Package Thermal Characteristics (Note 1)

TQFN
 Junction-to-Ambient Thermal Resistance (θ_{JA})29°C/W
 Junction-to-Case Thermal Resistance (θ_{JC}).....2°C/W

WLP
 Junction-to-Ambient Thermal Resistance (θ_{JA})44°C/W

Note 1: Package thermal resistances were obtained using the method described in JEDEC specification JESD51-7, using a four-layer board. For detailed information on package thermal considerations, refer to www.maximintegrated.com/thermal-tutorial.

Stresses beyond those listed under "Absolute Maximum Ratings" may cause permanent damage to the device. These are stress ratings only, and functional operation of the device at these or any other conditions beyond those indicated in the operational sections of the specifications is not implied. Exposure to absolute maximum rating conditions for extended periods may affect device reliability.

Electrical Characteristics

(V_{DVDD} = V_{AVDD} = +1.1V to +2.0V, V_{OVDD} = +1.65V to +3.6V, f_{FCLK} = 32.768kHz, T_A = T_{MIN} to T_{MAX}, unless otherwise noted. Typical values are at V_{DVDD} = V_{AVDD} = +1.8V, V_{OVDD} = +2.5V, T_A = +25°C.) (Note 2)

PARAMETER	SYMBOL	CONDITIONS	MIN	TYP	MAX	UNITS
ECG CHANNEL						
AC Differential Input Range		V _{AVDD} = +1.1V, THD < 0.3%	-15		+15	mV _{p-p}
		V _{AVDD} = +1.8V, THD < 0.3%	±32.5			
DC Differential Input Range		V _{AVDD} = +1.1V, shift from nominal gain < 2%	-300		+300	mV
		V _{AVDD} = +1.8V	±650			
Common Mode Input Range		V _{AVDD} = +1.1V, from V _{MID} , shift from nominal gain < 2%	-150		+150	mV
		V _{AVDD} = +1.8V, from V _{MID} , shift from nominal gain < 2%	±550			
Common Mode Rejection Ratio	CMRR	0Ω source impedance, f = 64Hz (Note 3)	105	115		dB
		(Note 4)	77			
ECG Channel Input Referred Noise		BW = 0.05 - 150Hz, G _{CH} = 20x	0.82			μV _{RMS}
			5.4			μV _{p-p}
		BW = 0.05 - 40Hz, G _{CH} = 20x (Note 3)	0.53	1.0		μV _{RMS}
			3.5	6.6		μV _{p-p}
Input Leakage Current		T _A = +25°C	-1	0.1	+1	nA
Input Impedance (INA)		Common-mode, DC	45			GΩ
		Differential, DC	1500			MΩ

Electrical Characteristics (continued)

($V_{DVDD} = V_{AVDD} = +1.1V$ to $+2.0V$, $V_{OVDD} = +1.65V$ to $+3.6V$, $f_{FCLK} = 32.768kHz$, $T_A = T_{MIN}$ to T_{MAX} , unless otherwise noted. Typical values are at $V_{DVDD} = V_{AVDD} = +1.8V$, $V_{OVDD} = +2.5V$, $T_A = +25^{\circ}C$.) (Note 2)

PARAMETER	SYMBOL	CONDITIONS	MIN	TYP	MAX	UNITS
ECG Channel Total Harmonic Distortion	THD	$V_{AVDD} = +1.80V$, $V_{IN} = 65mV_{p-p}$, $F_{IN} = 64Hz$, $G_{CH} = 20x$, electrode offset = $\pm 300mV$		0.025		%
		$V_{AVDD} = +1.1V$, $V_{IN} = 30mV_{p-p}$, $F_{IN} = 64Hz$, $G_{CH} = 20x$, electrode offset = $\pm 300mV$			0.3	
ECG Channel Gain Setting	G_{CH}	Programmable, see register map		20 to 160		V/V
ECG Channel Gain Error		$V_{AVDD} = +1.8V$, $G_{CH} = 20x$, $ECGP = ECGN = VMID$	-2.5		+2.5	%
		$V_{AVDD} = +1.1V$, $G_{CH} = 20x$, $ECGP = ECGN = VMID$	-4.5		+4.5	%
ECG Channel Offset Error		(Note 5)		0.1		% of FSR
ADC Resolution				18		Bits
ADC Sample Rate		Programmable, see register map		125 to 512		SPS
CAPP to CAPN Impedance	R_{HPF}	$FHP = 1/(2R \times R_{HPF} \times C_{HPF})$, C_{HPF} = capacitance between CAPP and CAPN	320	450	600	k Ω
Analog High-Pass Filter Slew Current		Fast recovery enabled (1.8V)		160		μA
		Fast recovery enabled (1.1V)		55		
		Fast recovery disabled		0.09		
Fast Settling Recovery Time		$C_{HPF} = 10\mu F$, Note: varies by sample rate, see Table 3.		500		ms
Digital Low-Pass Filter	Linear phase FIR filter.	DLPF[0:1] = 01		40		Hz
		DLPF[0:1] = 10		100		
		DLPF[0:1] = 11		150		
Digital High-Pass Filter		Phase-corrected 1st-order IIR filter. DHPF = 1		0.5		Hz
ECG Power Supply Rejection	PSRR	Lead bias disabled, DC		107		dB
		Lead bias disabled, $f_{SW} = 64Hz$		110		
ECG INPUT MUX						
DC Lead Off Check	Pullup/pulldown	DCLOFF_IMAG[2:0] = 001		5		nA
		DCLOFF_IMAG[2:0] = 010		10		
		DCLOFF_IMAG[2:0] = 011		20		
		DCLOFF_IMAG[2:0] = 100		50		
		DCLOFF_IMAG[2:0] = 101		100		

Electrical Characteristics (continued)

(V_{DVDD} = V_{AVDD} = +1.1V to +2.0V, V_{OVDD} = +1.65V to +3.6V, f_{FCLK} = 32.768kHz, T_A = T_{MIN} to T_{MAX}, unless otherwise noted. Typical values are at V_{DVDD} = V_{AVDD} = +1.8V, V_{OVDD} = +2.5V, T_A = +25°C.) (Note 2)

PARAMETER	SYMBOL	CONDITIONS		MIN	TYP	MAX	UNITS
DC Lead Off Comparator Low Threshold		DCLOFF_VTH[1:0] = 11 (Note 6)		V _{MID} - 0.50			V
		DCLOFF_VTH[1:0] = 10 (Note 7)		V _{MID} - 0.45			
		DCLOFF_VTH[1:0] = 01 (Note 8)		V _{MID} - 0.40			
		DCLOFF_VTH[1:0] = 00		V _{MID} - 0.30			
DC Lead Off Comparator High Threshold		DCLOFF_VTH[1:0] = 11 (Note 6)		V _{MID} + 0.50			V
		DCLOFF_VTH[1:0] = 10 (Note 7)		V _{MID} + 0.45			
		DCLOFF_VTH[1:0] = 01 (Note 8)		V _{MID} + 0.40			
		DCLOFF_VTH[1:0] = 00		V _{MID} + 0.30			
Lead Bias Impedance		Lead bias enabled	RBIASV[1:0] = 00	50		MΩ	
			RBIASV[1:0] = 01	100			
			RBIASV[1:0] = 10	200			
Lead Bias Voltage	V _{MID}	Lead bias enabled		V _{AVDD} /2.15		V	
Calibration Voltage Magnitude		Single-ended	VMAG = 0	0.25		mV	
			VMAG = 1	0.50			
Calibration Voltage Magnitude Error		Single-ended (Note 9)		-2		+2	%
Calibration Voltage Frequency		Programmable, see register map		0.0156 to 256		Hz	
Calibration Voltage Pulse Time		Programmable, see register map	FIFTY = 0	0.03052 to 62.474		ms	
			FIFTY = 1	50		%	
INTERNAL REFERENCE/Common-Mode							
V _{BG} Output Voltage	V _{BG}			0.650		V	
V _{BG} Output Impedance				100		kΩ	
External V _{BG} Compensation Capacitor	C _{VBG}			1		μF	
V _{REF} Output Voltage	V _{REF}	T _A = +25°C		0.995	1.000	1.005	V
V _{REF} Temperature Coefficient	TC _{REF}	T _A = 0°C to +70°C		10		ppm/°C	
V _{REF} Buffer Line Regulation				330		μV/V	
V _{REF} Buffer Load Regulation		I _{LOAD} = 0 to 100μA		25		μV/μA	

Electrical Characteristics (continued)

($V_{DVDD} = V_{AVDD} = +1.1V$ to $+2.0V$, $V_{OVDD} = +1.65V$ to $+3.6V$, $f_{FCLK} = 32.768kHz$, $T_A = T_{MIN}$ to T_{MAX} , unless otherwise noted. Typical values are at $V_{DVDD} = V_{AVDD} = +1.8V$, $V_{OVDD} = +2.5V$, $T_A = +25^{\circ}C$.) (Note 2)

PARAMETER	SYMBOL	CONDITIONS	MIN	TYP	MAX	UNITS
External V_{REF} Compensation Capacitor	C_{REF}		1	10		μF
V_{CM} Output Voltage	V_{CM}			0.650		V
External V_{CM} Compensation Capacitor	C_{CM}		1	10		μF
DIGITAL INPUTS (SDI, SCLK, CSB, FCLK)						
Input-Voltage High	V_{IH}		$0.7 \times V_{OVDD}$			V
Input-Voltage Low	V_{IL}			$0.3 \times V_{OVDD}$		V
Input Hysteresis	V_{HYS}			$0.05 \times V_{OVDD}$		V
Input Capacitance	C_{IN}			10		pF
Input Current	I_{IN}		-1		+1	μA
DIGITAL OUTPUTS (SDO, INTB, INT2B)						
Output Voltage High	V_{OH}	$I_{SOURCE} = 1mA$	$V_{OVDD} - 0.04$			V
Output Voltage Low	V_{OL}	$I_{SINK} = 1mA$			0.4	V
Three-State Leakage Current			-1		+1	μA
Three-State Output Capacitance				15		pF
POWER SUPPLY						
Analog Supply Voltage	V_{AVDD}	Connect V_{AVDD} to V_{DVDD}	1.1		2.0	V
Digital Supply Voltage	V_{DVDD}	Connect V_{DVDD} to V_{AVDD}	1.1		2.0	V
Interface Supply Voltage	V_{OVDD}	Power for I/O drivers only	1.65		3.6	V
Supply Current	$I_{AVDD} + I_{DVDD}$	ECG channel	$V_{AVDD} = V_{DVDD} = +1.1V$		76	μA
			$V_{AVDD} = V_{DVDD} = +1.8V$		100	
			$V_{AVDD} = V_{DVDD} = +2.0V$		109 120	
		ULP Lead On Detect	$T_A = +70^{\circ}C$		0.98	
$T_A = +25^{\circ}C$			0.73 2.5			
Interface Supply Current	I_{OVDD}	$V_{OVDD} = +1.65V$, ECG channel at 512sps (Note 10)		0.2	μA	
		$V_{OVDD} = +3.6V$, ECG channel at 512sps (Note 10)		0.6 1.6		

Electrical Characteristics (continued)

($V_{DVDD} = V_{AVDD} = +1.1V$ to $+2.0V$, $V_{OVDD} = +1.65V$ to $+3.6V$, $f_{CLK} = 32.768kHz$, $T_A = T_{MIN}$ to T_{MAX} , unless otherwise noted. Typical values are at $V_{DVDD} = V_{AVDD} = +1.8V$, $V_{OVDD} = +2.5V$, $T_A = +25^\circ C$.) (Note 2)

PARAMETER	SYMBOL	CONDITIONS	MIN	TYP	MAX	UNITS
Shutdown Current	$I_{SAVDD} + I_{SDVDD}$	$V_{AVDD} = V_{DVDD} = 2.0V$ $T_A = +70^\circ C$		0.79		μA
		$T_A = +25^\circ C$		0.51	2.5	
	I_{SOVDD}	$V_{OVDD} = +3.6V$, $V_{AVDD} = V_{DVDD} = +2.0V$			1.1	
ESD PROTECTION						
ECGP, ECGN		IEC61000-4-2 Contact Discharge (Note 11)		± 8		kV
		IEC61000-4-2 Air-Gap Discharge (Note 11)		± 15		
		HMM		± 8		

Timing Characteristics

($V_{DVDD} = V_{AVDD} = +1.1V$ to $+2.0V$, $V_{OVDD} = +1.65V$ to $+3.6V$, $T_A = T_{MIN}$ to T_{MAX} , unless otherwise noted. Typical values are at $V_{DVDD} = +1.8V$, $V_{OVDD} = +2.5V$, $T_A = +25^\circ C$.) (Notes 2, 3)

PARAMETER	SYMBOL	CONDITIONS	MIN	TYP	MAX	UNITS
TIMING CHARACTERISTICS						
SCLK Frequency	f_{SCLK}		0		12	MHz
SCLK Period	t_{CP}		83			ns
SCLK Pulse Width High	t_{CH}		15			ns
SCLK Pulse Width Low	t_{CL}		15			ns
CSB Fall to SCLK Rise Setup Time	t_{CSS0}	To 1st SCLK rising edge (RE)	15			ns
CSB Fall to SCLK Rise Hold Time	t_{CSH0}	Applies to inactive RE preceding 1st RE	0			ns
CSB Rise to SCLK Rise Hold Time	t_{CSH1}	Applies to 32nd RE, executed write	10			ns
CSB Rise to SCLK Rise	t_{CSA}	Applies to 32nd RE, aborted write sequence	15			ns
SCLK Rise to CSB Fall	t_{CSF}	Applies to 32nd RE	100			ns
CSB Pulse-Width High	t_{CSPW}		20			ns
SDI-to-SCLK Rise Setup Time	t_{DS}		8			ns
SDI to SCLK Rise Hold Time	t_{DH}		8			ns
SCLK Fall to SDO Transition	t_{DOT}	$C_{LOAD} = 20pf$			40	ns
		$C_{LOAD} = 20pf$, $V_{AVDD} = V_{DVDD} \geq 1.8V$, $V_{DVDD} \geq 2.5V$			20	ns
SCLK Fall to SDO Hold	t_{DOH}	$C_{LOAD} = 20pf$	2			ns

Timing Characteristics (continued)

($V_{DVDD} = V_{AVDD} = +1.1V$ to $+2.0V$, $V_{OVDD} = +1.65V$ to $+3.6V$, $T_A = T_{MIN}$ to T_{MAX} , unless otherwise noted. Typical values are at $V_{DVDD} = +1.8V$, $V_{OVDD} = +2.5V$, $T_A = +25^{\circ}C$.) (Notes 2, 3)

PARAMETER	SYMBOL	CONDITIONS	MIN	TYP	MAX	UNITS
CSB Fall to SDO Fall	t_{DOE}	Enable time, $C_{LOAD} = 20pf$			30	ns
CSB Rise to SDO Hi-Z	t_{DOZ}	Disable time			35	ns
FCLK Frequency	f_{FCLK}	External reference clock		32.768		kHz
FCLK Period	t_{FP}			30.52		μs
FCLK Pulse-Width High	t_{FH}	50% duty cycle assumed		15.26		μs
FCLK Pulse-Width Low	t_{FL}	50% duty cycle assumed		15.26		μs

- Note 2:** Limits are 100% tested at $T_A = +25^{\circ}C$. Limits over the operating temperature range and relevant supply voltage range are guaranteed by design and characterization.
- Note 3:** Guaranteed by design and characterization. Not tested in production.
- Note 4:** One electrode drive with $<10\Omega$ source impedance, the other driven with $51k\Omega$ in parallel with a $47nF$ per IEC60601-2-47.
- Note 5:** Inputs connected to $51k\Omega$ in parallel with a $47nF$ to V_{CM} .
- Note 6:** Use this setting only for $V_{AVDD} = V_{DVDD} \geq 1.65V$.
- Note 7:** Use this setting only for $V_{AVDD} = V_{DVDD} \geq 1.55V$.
- Note 8:** Use this setting only for $V_{AVDD} = V_{DVDD} \geq 1.45V$.
- Note 9:** This specification defines the accuracy of the calibration voltage source as applied to the ECG input, not as measured through the ADC channel.
- Note 10:** $f_{SCLK} = 4MHz$, burst mode, $EFIT = 8$, $C_{SDO} = C_{INTB} = 50pF$.
- Note 11:** ESD test performed with $1k\Omega$ series resistor designed to withstand $8kV$ surge voltage.

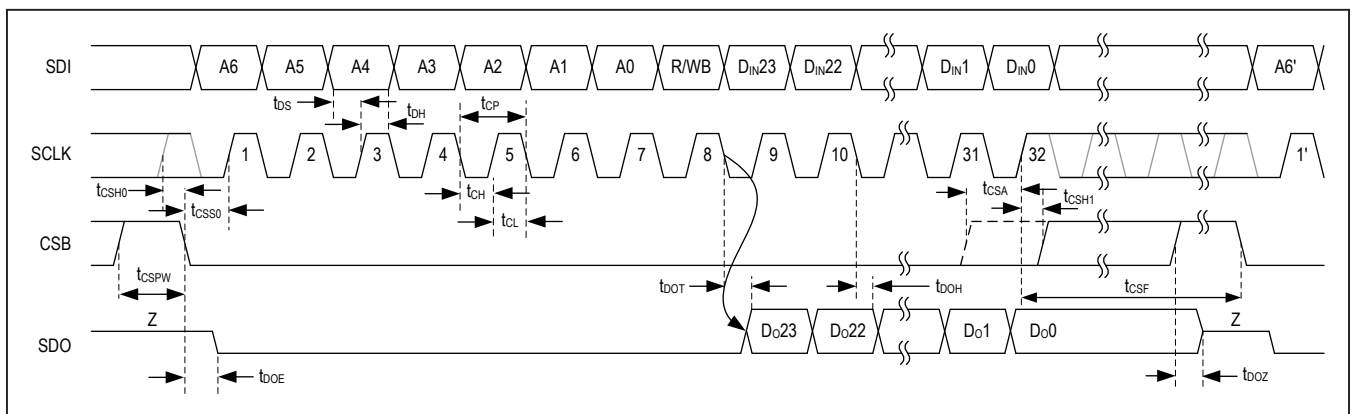

Figure 1a. SPI Timing Diagram

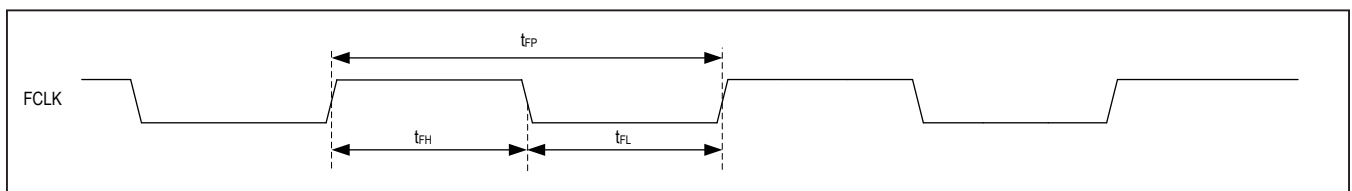
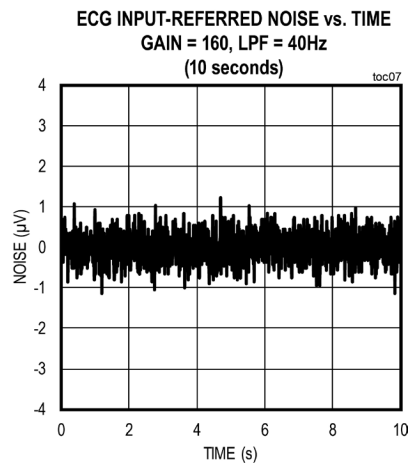
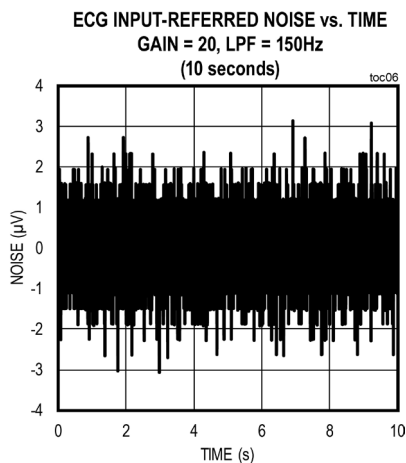
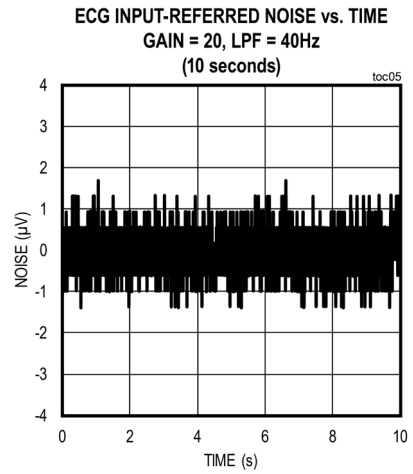
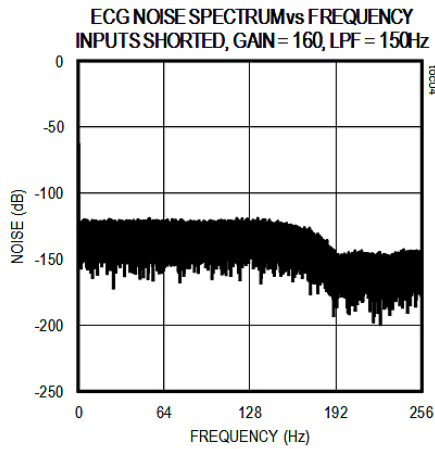
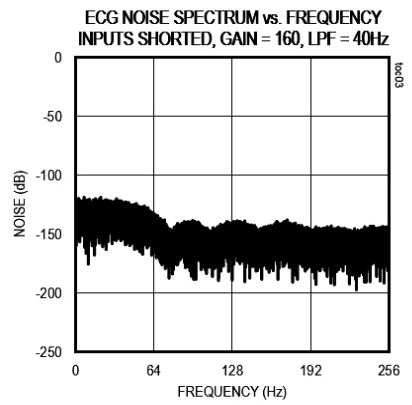
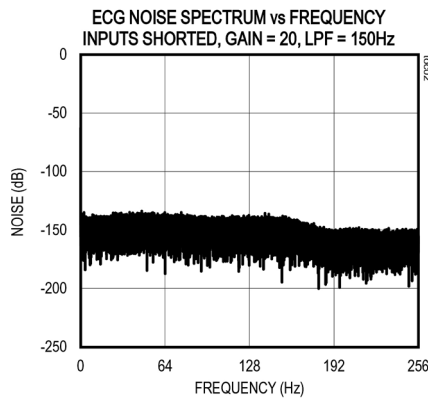
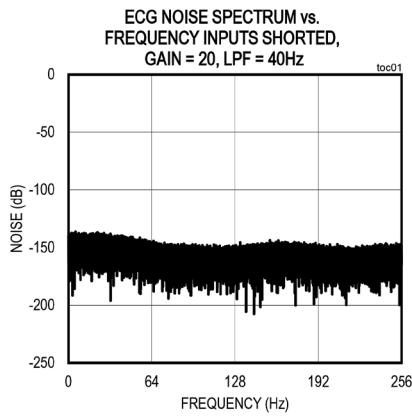

Figure 1b. FCLK Timing Diagram

Typical Operating Characteristics

($V_{DVDD} = V_{AVDD} = +1.8V$, $V_{OVDD} = 2.5V$, $T_A = +25^\circ C$, unless otherwise noted.)



Typical Operating Characteristics (continued)

($V_{DVDD} = V_{AVDD} = +1.8V$, $V_{OVDD} = 2.5V$, $T_A = +25^\circ C$, unless otherwise noted.)

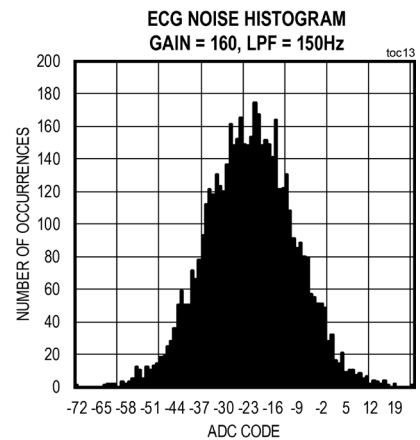
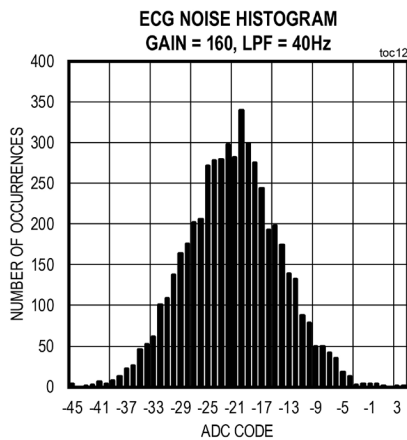
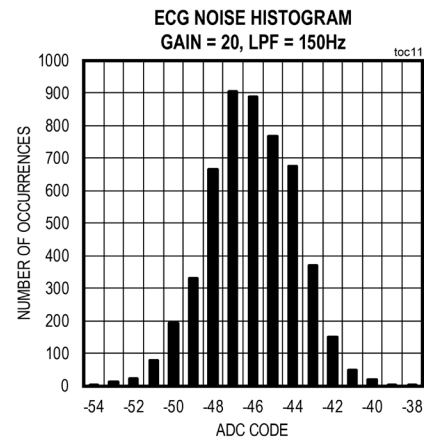
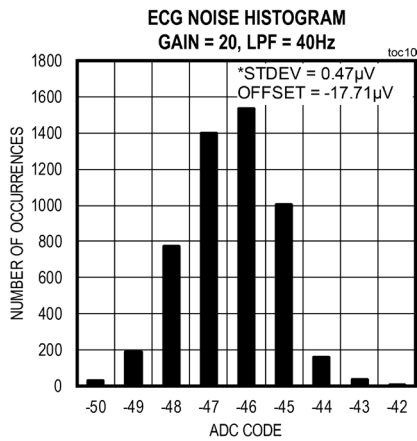
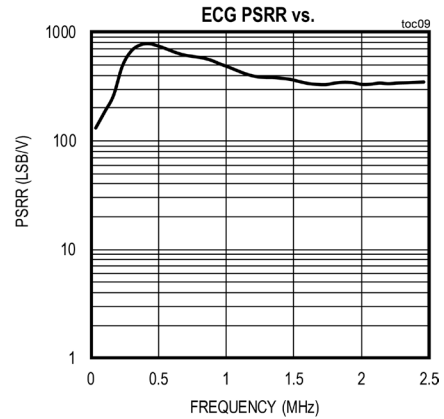
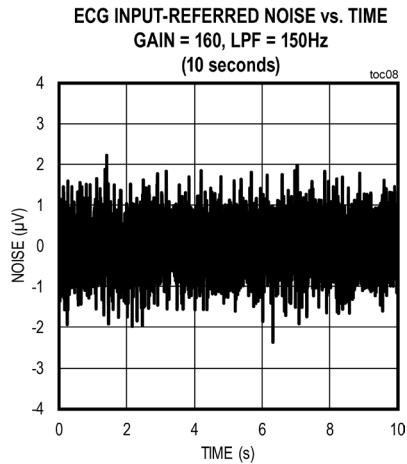

Typical Operating Characteristics (continued)

($V_{DVDD} = V_{AVDD} = +1.8V$, $V_{OVDD} = 2.5V$, $T_A = +25^\circ C$, unless otherwise noted.)

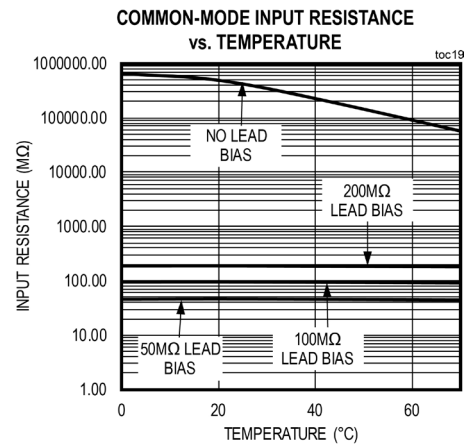
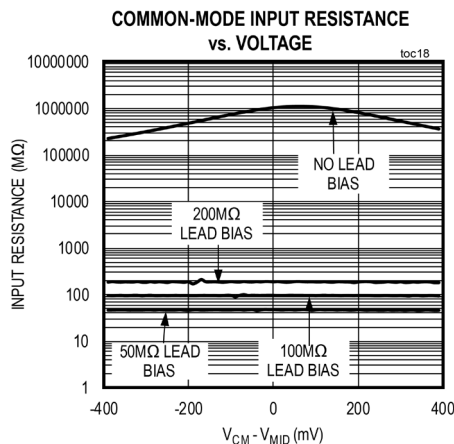
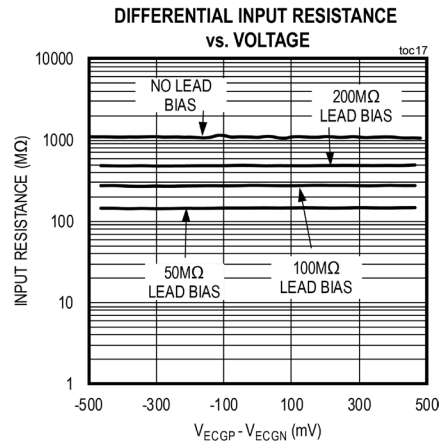
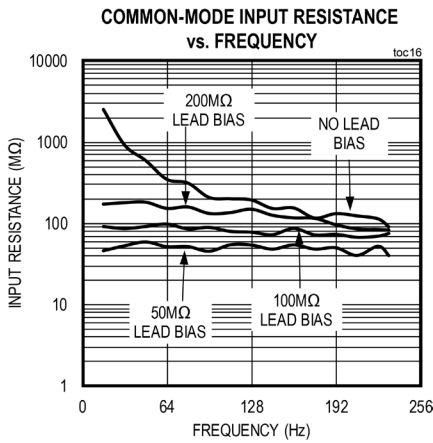
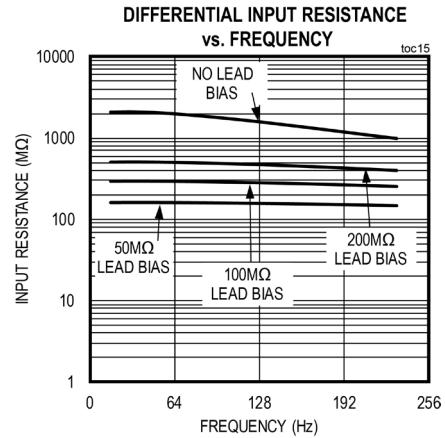
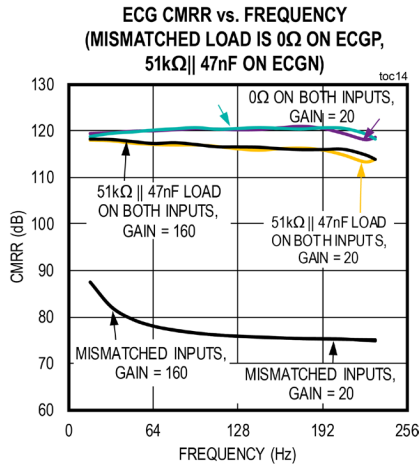

Typical Operating Characteristics (continued)

($V_{DVDD} = V_{AVDD} = +1.8V$, $V_{OVDD} = 2.5V$, $T_A = +25^\circ C$, unless otherwise noted.)

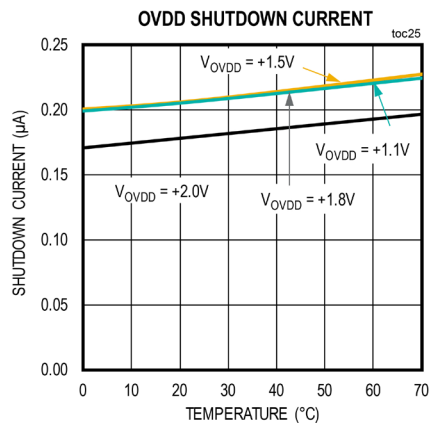
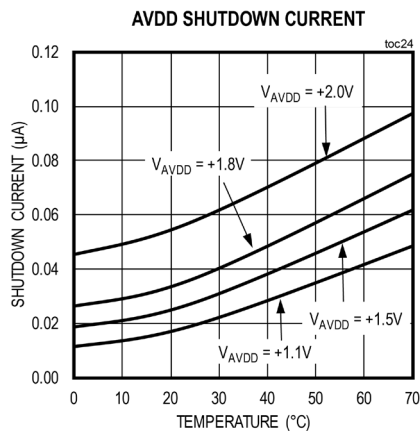
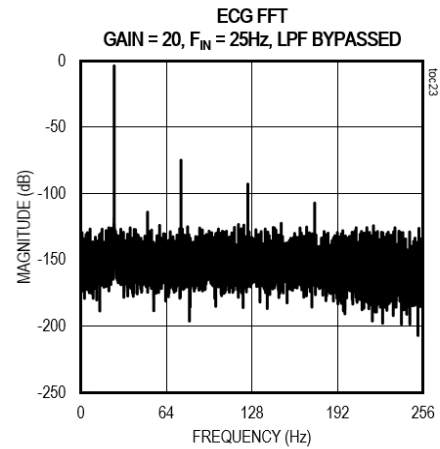
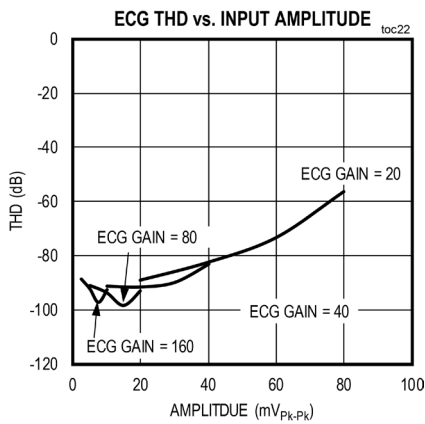
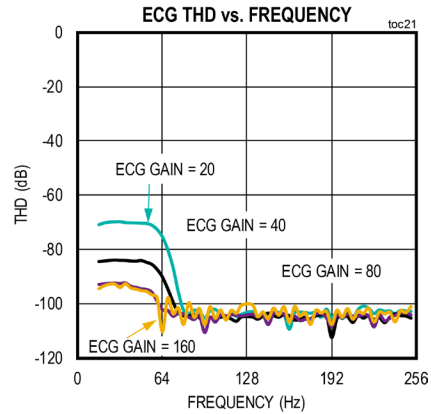
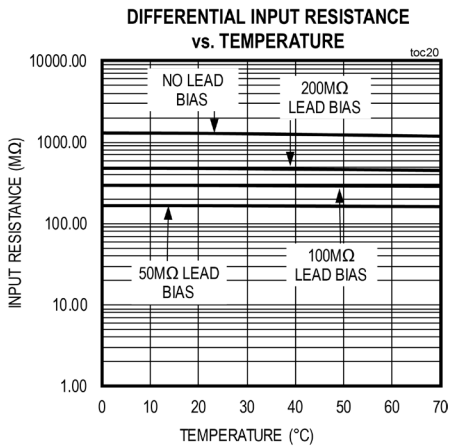

MAX30003

Ultra-Low Power, Single-Channel Integrated Biopotential (ECG, R-to-R Detection) AFE

Pin Configurations

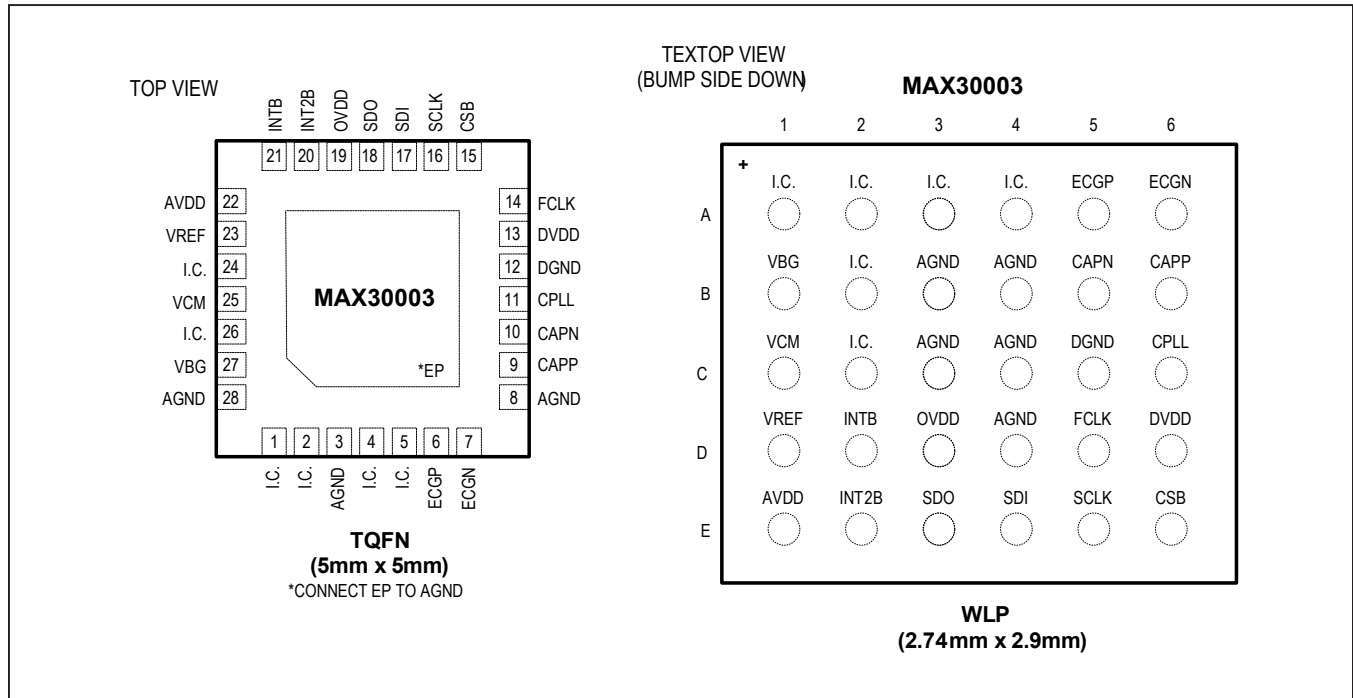

Pin Description

PIN	BUMP	NAME	FUNCTION
TQFN	WLP		
1, 2, 4, 5, 24, 26	A1, A2, A3, A4, B2, C2	I.C.	Internally Connected. Connect to AGND.
3, 8, 28	B3, B4, C3, C4, D4	AGND	Analog Power and Reference Ground. Connect into the printed circuit board ground plane.
6	A5	ECGP	ECG Positive Input
7	A6	ECGN	ECG Negative Input
9	B6	CAPP	Analog High-Pass Filter Input. Connect a 1µF X7R capacitor (CHPF) between CAPP and CAPN to form a 0.5Hz high-pass response in the ECG channel.
10	B5	CAPN	Analog High-Pass Filter Input. Connect a 1µF X7R capacitor (CHPF) between CAPP and CAPN to form a 0.5Hz high-pass response in the ECG channel.
11	C6	CPLL	PLL Loop Filter Input. Connect 1nF COG cap between CPLL and AGND.
12	C5	DGND	Digital Ground for Both Digital Core and I/O Pad Drivers. Recommended to connect to AGND plane.
13	D6	DVDD	Digital Core Supply Voltage. Connect to AVDD

Pin Description (continued)

PIN	BUMP	NAME	FUNCTION
TQFN	WLP		
14	D5	FCLK	External 32.768kHz Clock that Controls the Sampling of the Internal Sigma-Delta Converters and Decimator.
15	E6	CSB	Active-Low Chip-Select Input. Enables the serial interface.
16	E5	SCLK	Serial Clock Input. Clocks data in and out of the serial interface when CSB is low.
17	E4	SDI	Serial Data Input. SDI is sampled into the device on the rising edge of SCLK when CSB is low.
18	E3	SDO	Serial Data Output. SDO will change state on the falling edge of SCLK when CSB is low. SDO is three-stated when CSB is high.
19	D3	OVDD	Logic Interface Supply Voltage
20	E2	INT2B	Interrupt 2 Output. INT2B is an active-low status output. It can be used to interrupt an external device.
21	D2	INTB	Interrupt Output. INTB is an active low status output. It can be used to interrupt an external device.
22	E1	AVDD	Analog Core Supply Voltage. Connect to DVDD.
23	D1	V _{REF}	ADC Reference Buffer Output. Connect a 10μF X5R ceramic capacitor between V _{REF} and AGND.
25	C1	V _{CM}	Common Mode Buffer Output. Connect a 10μF X5R ceramic capacitor between V _{CM} and AGND.
27	B1	V _{BG}	Bandgap Noise Filter Output. Connect a 1.0μF X7R ceramic capacitor between V _{BG} and AGND.
EP	—	—	Exposed Paddle. Connect to AGND.

Detailed Description

ECG Channel

Figure 2 illustrates the ECG channel block diagram, excluding the ADC. The channel comprises an input MUX, a fast-recovering instrumentation amplifier, an anti-alias filter, and a programmable gain amplifier. The MUX includes several features such as ESD protection, EMI filtering, lead biasing, leads off checking, and ultra-low power leads-on checking. The output of this analog channel drives a high-resolution ADC.

Input MUX

The ECG input MUX shown in Figure 3 contains integrated ESD and EMI protection, DC leads off detect current sources, lead-on detect, series isolation switches, lead biasing, and a programmable calibration voltage source to enable channel built-in self-test.

EMI Filtering and ESD Protection

EMI filtering of the ECGP and ECGN inputs consists of a single pole, low pass, differential, and common mode filter with the pole located at approximately 2MHz. The ECGP and ECGN inputs also have input clamps that protect the inputs from ESD events.

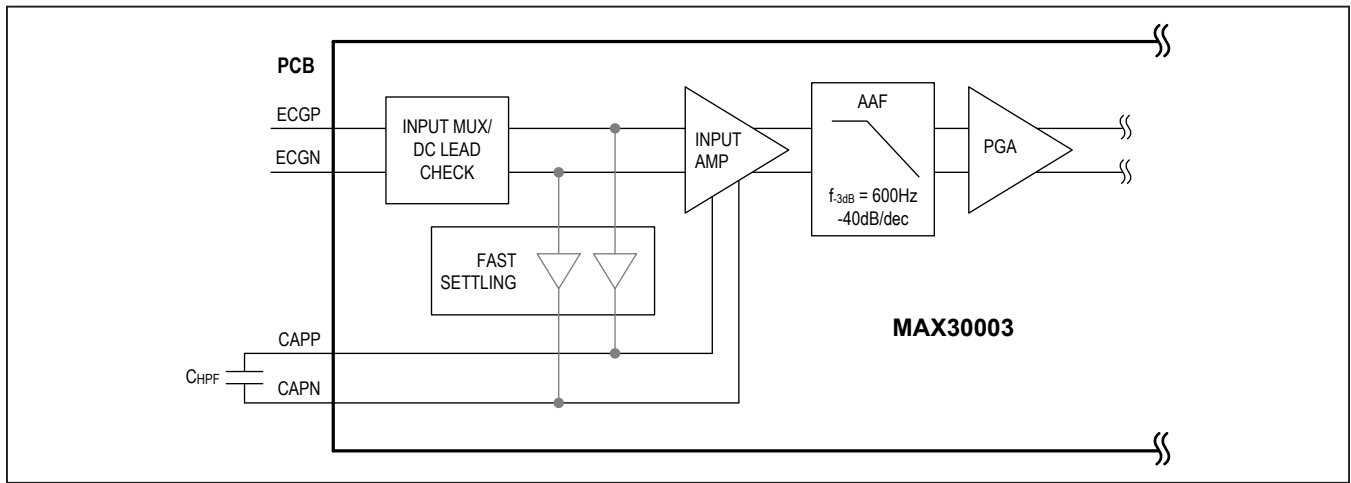

Figure 2. ECG Channel Input Amplifier and PGA Excluding the ADC

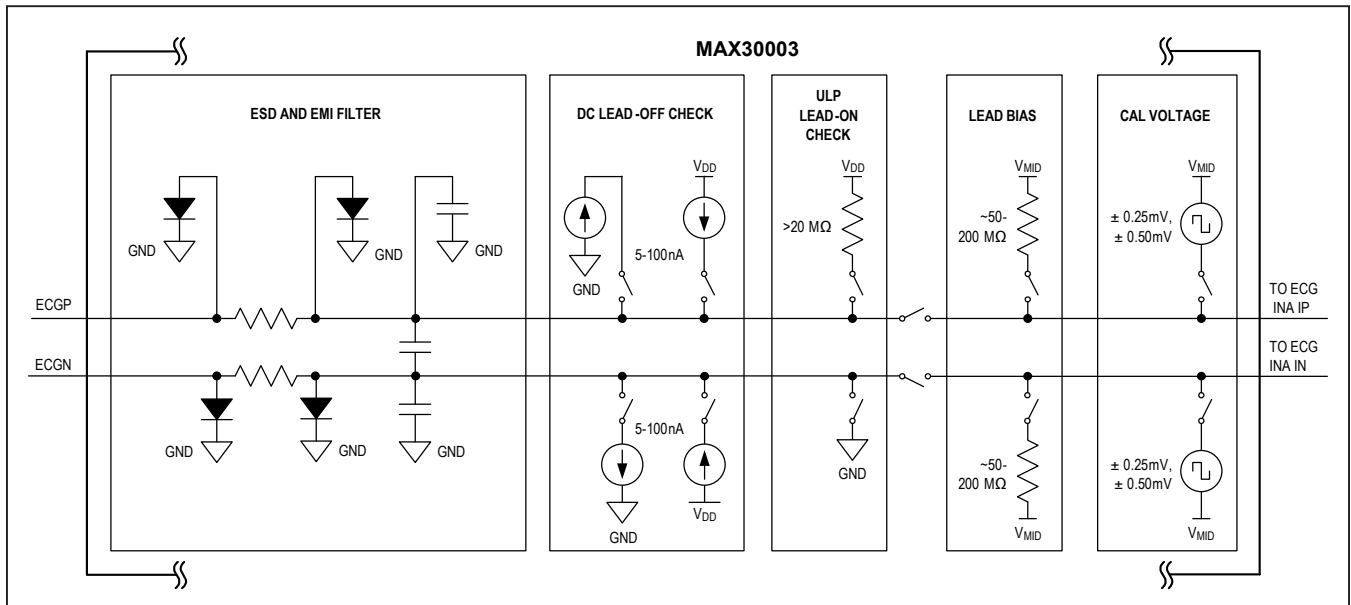

Figure 3. ECG Input MUX

- ±8kV using the Contact Discharge method specified in IEC61000-4-2 ESD
- ±15kV using the Air Gap Discharge method specified in IEC61000-4-2 ESD
- ±8kV HBM
- For IEC61000-4-2 ESD protection, use 1kΩ series resistors on ECGP and ECGN that is rated to withstand 8kV surge voltages.

DC Leads-Off Detection and ULP Leads-On Detection

The input MUX leads-off detect circuitry consists of programmable sink/source DC current sources that allow for DC leads-off detection, while the channel is powered up in normal operation and an ultra-low-power (ULP) leads-on detect while the channel is powered-down.

The MAX30003 accomplishes DC leads-off detection by applying a DC current to pull the ECG input voltage up to above $V_{MID} + V_{TH}$ or down to below $V_{MID} - V_{TH}$. The current sources have user selectable values of 0nA, 5nA, 10nA, 20nA, 50nA, and 100nA that allow coverage of dry and wet electrode impedance ranges. Supported thresholds are $V_{MID} \pm 0.30V$ (recommended), $V_{MID} \pm 0.40V$, $V_{MID} \pm 0.45V$, and $V_{MID} \pm 0.50V$. A threshold of 400mV, 450mV, and 500mV should only be used when $V_{AVDD} \geq 1.45V$, 1.55V, and 1.65V, respectively. A dynamic comparator protects against false flags generated by the input amplifier and input chopping. The comparator checks for a minimum continuous violation (or threshold exceeded) of 115ms to 140ms depending on the setting of FMSTR[1:0] before asserting any one of the LDOFF_* interrupt flags (Figure 4). See registers CNFG_GEN (0x10) and CNFG_EMUX (0x14) for configuration settings and see Table 1 for recommended values given electrode type and supply voltage.

The ULP lead on detect operates by pulling ECGN low with a pulldown resistance larger than 5mΩ and pulling ECGP high with a pullup resistance larger than 15MΩ. A low-power comparator determines if ECGP is pulled below a predefined threshold that occurs when both electrodes make contact with the body. When the impedance between ECGP and ECGN is less than 20mΩ, an interrupt LONINT is asserted, alerting the μC to a leads-on condition.

A 0nA/ $V_{MID} \pm 300mV$ selection is available allowing monitoring of the input compliance of the INA during non-DC lead-off checks.

Lead Bias

The MAX30003 limits the ECGP and ECGN DC input common mode range to $V_{MID} \pm 150mV$. This range can be maintained either through external/internal lead-biasing.

Internal DC lead-biasing consists of 50MΩ, 100MΩ, or 200MΩ selectable resistors to V_{MID} that drive the

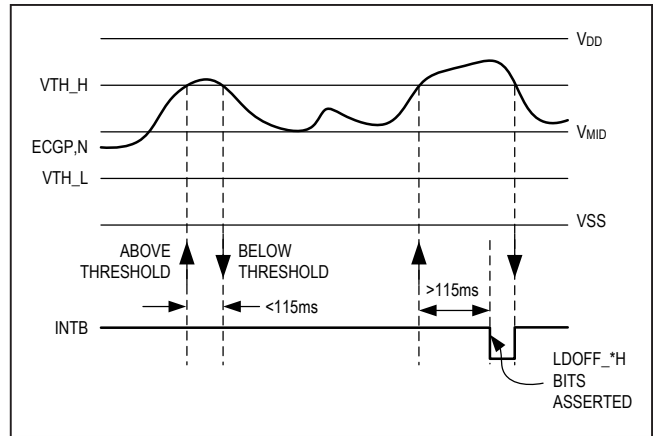

Figure 4. Lead-Off Detect Behavior

electrodes within the input common mode requirements of the ECG channel and can drive the connected body to the proper common mode voltage level. See register CNFG_GEN (0x10) to select a configuration.

Isolation Switches

The series switches in the MAX30003 isolate ECGP and ECGN pins (subject) from the internal signal path. The series switches are disabled by default. They must be enabled to record ECG.

Calibration Voltage Sources

Calibration voltage sources are available to provide $\pm 0.25mV$ (0.5mV_{P-P}) or $\pm 0.5mV$ (1.0mV_{P-P}) inputs to the ECG channel with programmable frequency and duty cycle. The sources can be unipolar/bipolar relative to V_{MID} .

Figure 5 illustrates the possible calibration waveforms. Frequency selections are available in 4X increments from 15.625mHz to 256Hz with selected pulse widths varying from 30.5μs to 31.723ms and 50% duty cycle. Signals can be single-ended, differential, or common mode. This flexibility allows end-to-end channel-testing of the ECG signal path.

When applying calibration voltage sources with the device connected to a subject, the series input switches must be disconnected so as not to drive signals into the subject. See registers CNFG_CAL (0x12) and CNFG_EMUX (0x14) to select configuration.

Table 1. Recommended Lead Bias, Current Source Values, and Thresholds for Electrode Impedance

I_{DC} V_{TH}	ELECTRODES IMPEDANCE							
	<100kΩ	100kΩ - 200kΩ	200kΩ - 400kΩ	400kΩ - 1MΩ	1MΩ - 2MΩ	2MΩ - 4 MΩ	4MΩ - 10MΩ	10MΩ - 20MΩ
$I_{DC} = 10nA$	All settings of R_b $V_{TH} = V_{MID}$ $\pm 300mV, \pm 400mV$							
$I_{DC} = 20nA$	All settings of R_b All settings of V_{TH}							All settings of R_b $V_{TH} = V_{MID}$ $\pm 400mV, \pm 450mV, \pm 500mV$
$I_{DC} = 50nA$	All settings of R_b All settings of V_{TH}						All settings of R_b $V_{TH} = V_{MID}$ $\pm 450mV, \pm 500mV$	
$I_{DC} = 100nA$	All settings of R_b All settings of V_{TH}					All settings of R_b $V_{TH} = V_{MID}$ $\pm 400mV, \pm 450mV, \pm 500mV$		

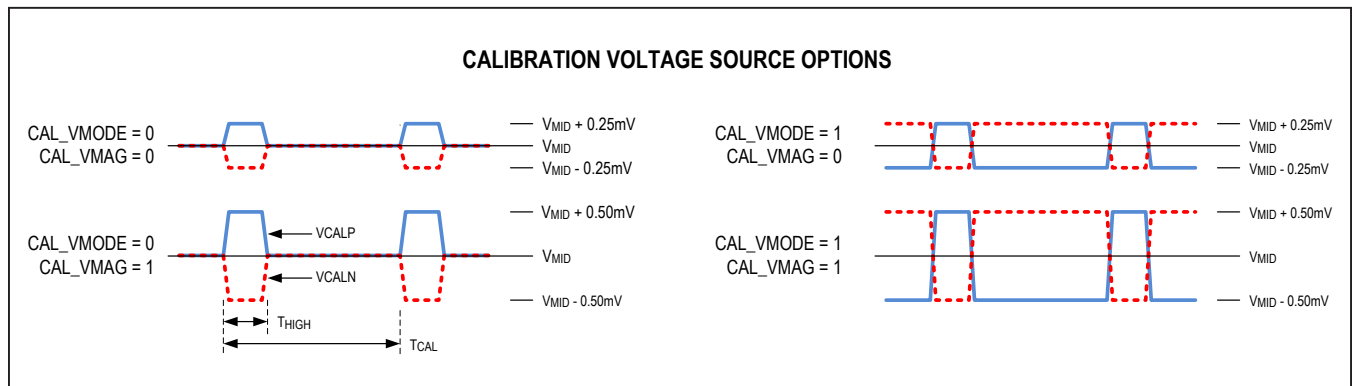

Figure 5. Calibration Voltage Source Options

Gain Settings and Input Range

The device's ECG channel contains an input instrumentation amplifier that provides low-noise, fixed-gain amplification of the differential signal, rejects differential DC voltage due to electrode polarization, rejects common-mode interference primarily due to AC mains interference, and provides high input impedance to guarantee high CMRR even in the presence of severe electrode impedance mismatch (see [Figure 2](#)). The differential DC rejection corner frequency is set by an external capacitor (C_{HPF}) placed between pins CAPP and CAPN, refer to [Table 2](#) for appropriate value selection. There are three recommended options for the cutoff frequency: 4.4Hz, 0.4Hz, and 0.04Hz. Setting the cutoff frequency to 4.4Hz provides the most motion artifact rejection at the expense of ECG waveform quality, making it best suited for heart rate monitoring. For ambulatory applications requiring more robust ECG waveforms with moderate motion artifact rejection, 0.4Hz is recommended. Select 0.04Hz for patient monitoring applications in which ECG waveform quality is the primary concern and poor rejection of motion artifacts can be tolerated. The high-pass corner frequency is calculated by the following equation:

$$1/(2\pi \times R_{HPF} \times C_{HPF})$$

R_{HPF} is specified in the [Electrical Characteristics](#) table.

Following the instrumentation amplifier is a 2-pole active anti-aliasing filter with a 600Hz -3dB frequency that provides 57dB of attenuation at half the modulator sampling rate (approximately 16kHz) and a PGA with programmable gains of 1, 2, 4, and 8V/V for an overall gain of 20, 40, 80, and 160V/V. The instrumentation amplifier and PGA are chopped to minimize offset and 1/f noise. Gain settings are configured via the CNFG_ECG (0x15) register. The useable common-mode range is $V_{MID} \pm 150\text{mV}$, internal lead biasing can be used to meet this requirement. The useable DC differential range is $\pm 300\text{mV}$ to allow for electrode polarization voltages on each electrode. The input AC differential range is $\pm 32.5\text{mV}$ or $\pm 65\text{mV}_{P-P}$.

Fast Recovery Mode

The input instrumentation amplifier has the ability to rapidly recover from an excessive overdrive event such as a defibrillation pulse, high-voltage external pacing, and electro-surgery interference. There are two modes of recovery that can be used: automatic or manual recovery. The mode is programmed by the FAST[1:0] bits in the MNGR_DYN (0x05) register.

Automatic mode engages once the saturation counter exceeds approximately 125ms (t_{SAT}). The counter is activated the first time the ADC output exceeds the symmetrical threshold defined by the FAST_TH[5:0] bits

in the MNGR_DYN (0x05) register and accumulates the time that the ADC output exceeds either the positive or negative threshold. If the saturation counter exceeds 125ms, it triggers the fast settling mode (if enabled) and resets. The saturation counter can also be reset prior to triggering the fast settling mode if the ADC output falls below the threshold continuously for 125ms (t_{BLW}). This feature is designed to avoid false triggers due to the QRS complex. Once triggered, fast settling mode will be engaged for 500ms, see [Figure 6](#). ECG samples are tagged if they were taken while fast settling mode was asserted.

In manual mode, a user algorithm running on the host microcontroller or an external stimulus input will generate the trigger to enter fast recovery mode. The host microcontroller then enables the manual fast recovery mode in the MNGR_DYN (0x05) register. The manual fast recovery mode can be of a much shorter duration than the automatic mode and allows for more rapid recovery. One such example is recovery from external high-voltage pacing signals in a few milliseconds to allow the observation of a subsequent p-wave.

Table 2. ECG Analog HPF Corner Frequency Selection

C_{HPF}	HPF CORNER FREQUENCY
0.1 μ	$\leq 5\text{Hz}$
1.0 μ	$\leq 0.5\text{Hz}$
10 μ	$\leq 0.05\text{Hz}$

Table 3. Fast Recovery Mode Recovery Time vs. Number of Samples

SAMPLE RATE (sps)	NUMBER OF SAMPLES	RECOVERY TIME (APPROXIMATE) (ms)
512	255	498
256	127	496
128	63	492
500	249	498
250	124	496
125	64	512
200	99	495
199.8	99	495.5

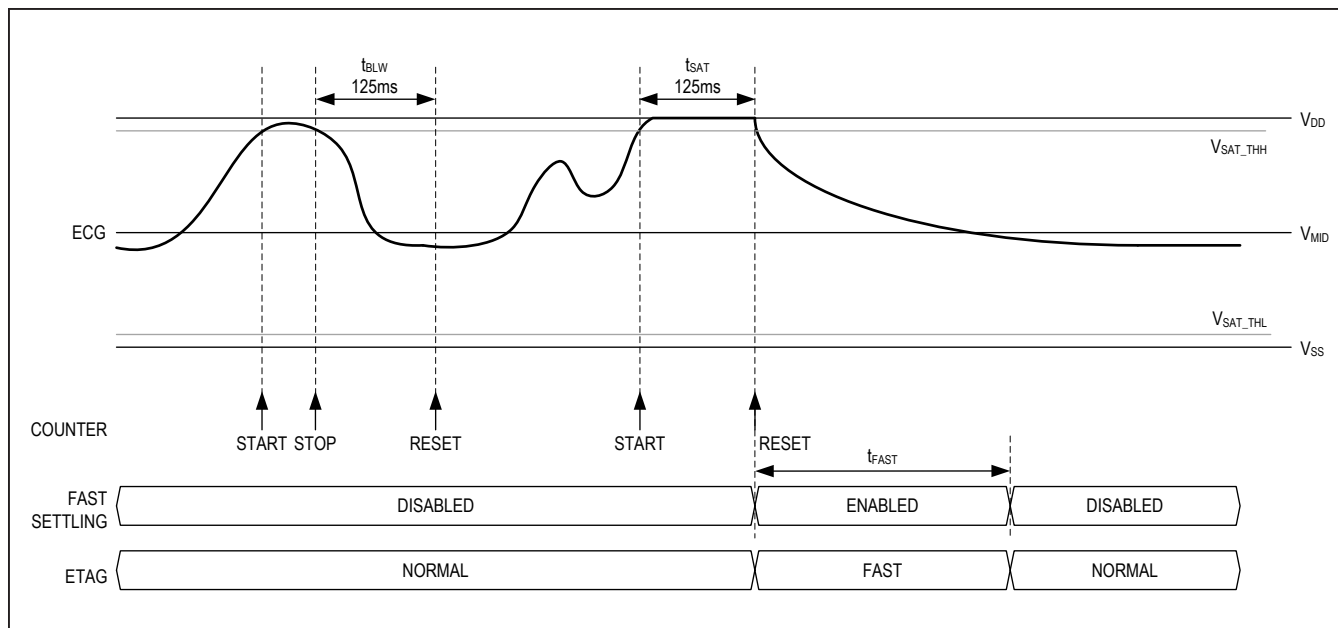

Figure 6. Automatic Fast Settling Behavior

Decimation Filter

The decimation filter consists of a Cascaded Integrator Comb (CIC) decimation filter to the data rate followed by a programmable FIR filter to implement HPF and LPF selections.

The high-pass filter options include a 1st-order IIR Butterworth filter with a 0.4Hz corner frequency along with a pass-through setting for DC coupling.

Low-pass filter options include a 12-tap linear phase (constant group delay) FIR filter with approximately 40Hz, 100Hz, or 150Hz corner frequencies, depending on the sampling rate. See register CNFG_ECG (0x15) to configure the filters. Table 4 illustrates the ECG latency in samples and time for each ADC data rate.

Table 4. ECG Latency in Samples and Time as a Function of ECG Data Rate and Decimation

ECG CHANNEL SETTINGS			LATENCY			
INPUT SAMPLE RATE (Hz)	OUTPUT DATA RATE (sps)	DECIMATION RATIO	WITHOUT LFP (INPUT SAMPLES)	WITH LFP (INPUT SAMPLES)	WITHOUT LFP (ms)	WITH LFP (ms)
32,768	512	64	650	1,034	19.836	31.555
32,000	500	64	650	1,034	20.313	32.313
32,768	256	128	2,922	3,690	89.172	112.610
32,000	250	128	2,922	3,690	91.313	115.313
32,000	200	160	1,242	2,202	38.813	68.813
31,968	199.8	160	1,242	2,202	38.851	68.881
32,768	128	256	3,370	4,906	102.844	149.719
32,000	125	256	3,370	4,906	105.313	153.313

Noise Measurements

Table 5 shows the noise performance of the ECG channel of MAX30003 referred to the ECG inputs.

R-to-R Detection

The MAX30003 contains built-in hardware to detect R-R intervals using an adaptation of the Pan-Tompkins QRS detection algorithm¹. The timing resolution of the R-R interval is approximately 8ms and depends on the setting of FMSTR [1:0] in CNFG_GEN (0x10) register. See Table 22 for the timing resolution of each setting.

When an R event is identified, the RRINT status bit is asserted and the RTOR_REG (0x25) register is updated with the count seen since the last R event. Figure 7 illustrates the R-R interval on a QRS complex. Refer to registers CNFG_RTOR1 (0x1D) and CNFG_RTOR2 (0x1E) for selection details.

Table 5. Biopotential (ECG) Channel Noise Performance

GAIN	BANDWIDTH	NOISE		SNR	ENOB
		μV_{RMS}	μV_{PP}		
V/V	Hz			dB	Bits
20	40	0.53	3.50	96.5	15.7
	100	0.64	4.20	94.9	15.5
	150	0.82	5.44	92.6	15.1
40	40	0.40	2.64	92.9	15.1
	100	0.54	3.56	90.3	14.7
	150	0.66	4.34	88.6	14.4
80	40	0.35	2.31	88.0	14.3
	100	0.50	3.33	84.9	13.8
	150	0.62	4.09	83.1	13.5
160	40	0.34	2.22	82.4	13.4
	100	0.49	3.24	79.1	12.8
	150	0.61	4.01	77.2	12.5

Note: $\text{SNR} = 20\log\left(\frac{V_{\text{IN}}(\text{RMS})}{V_{\text{N}}(\text{RMS})}\right)$, $\text{ENOB} = (\text{SNR} - 1.76)/6.02$

Note: $V_{\text{INP-P}} = 100\text{mV}$, $V_{\text{INRMS}} = 35.4\text{mV}$ for a gain of 20V/V. The input amplitude is reduced accordingly for high gain settings.

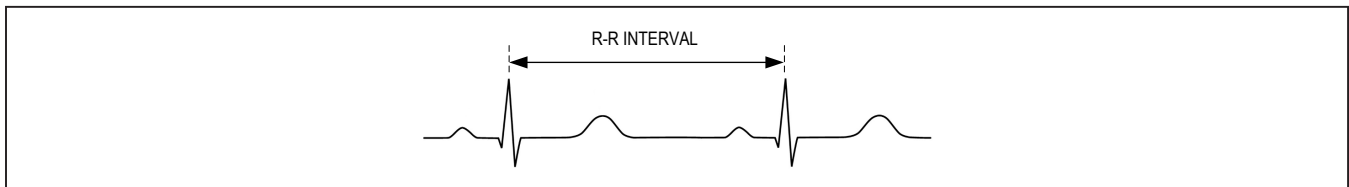

Figure 7. R-to-R Interval Illustration

¹J. Pan and W.J. Tompkins, "A Real-Time QRS Detection Algorithm," *IEEE Trans. Biomed. Eng.*, vol. 32, pp. 230-236

The latency of the R-to-R value written to the RTOR Interval Memory Register is the sum of the R-to-R decimation delay and the R-to-R detection delay blocks. The R-to-R decimation factor is fixed at 256 and the decimation delay (t_{R2R_DEC}) is always 3,370 FMSTR clocks, as shown in [Table 6](#).

The detection circuit consists of several digital filters and signal processing delays. These depend on the WNDW[3:0] bits in the CNFG_RTOR (0x1D) register. The detection delay (t_{R2R_DET}) is described by the following equation:

$t_{R2R_DET} = 5,376 + 256 \times \text{WNDW}$ in FMSTR clocks where WNDW is an integer from 0 to 15 and the total latency (t_{R2R_DEL}) is the sum of the two delays and summarized in the equation below:

$$t_{R2R_DEL} = t_{R2R_DEC} + t_{R2R_DET} = 3,370 + 5,376 + 256 \times \text{WNDW}$$

in FMSTR clocks where WNDW is an integer from 0 to 15.

The total R-to-R latency minus the ECG latency is delay of the R-to-R value relative to the ECG data and can be used to place the first R-to-R value on the ECG data plot. The succeeding values in the R-to-R Interval Memory Register can be used as is to locate subsequent R-to-R values on the ECG data plot relative to the initial placement.

Reference and Common Mode Buffer

The MAX30003 features internally generated reference voltages. The bandgap output (V_{BG}) pin requires an external 1.0 μ F capacitor to AGND and the reference output (V_{REF}) pin requires a 10 μ F external capacitor to AGND for compensation and noise filtering.

A common-mode buffer is provided to buffer 650mV which is used to drive common mode voltages for internal

blocks. Use a 10 μ F external capacitor between V_{CM} to AGND to provide compensation and noise filtering.

SPI Interface Description

32 Bit Normal Mode Read/Write Sequences

The MAX30003 interface is SPI/QSPI/Micro-wire/DSP compatible. The operation of the SPI interface is shown in [Figure 1](#). Data is strobed into the MAX30003 on SCLK rising edges. The device is programmed and accessed by a 32 cycle SPI instruction framed by a CSB low interval. The content of the SPI operation consists of a one byte command word (comprised of a seven bit address and a Read/Write mode indicator, i.e., A[6:0] + R/W) followed by a three-byte data word. The MAX30003 is compatible with CPOL = 0/CPHA = 0 and CPOL = 1/CPHA = 1 modes of operation.

Write mode operations will be executed on the 32nd SCLK rising edge using the first four bytes of data available. In write mode, any data supplied after the 32nd SCLK rising edge will be ignored. Subsequent writes require CSB to de-assert high and then assert low for the next write command. In order to abort a command sequence, the rise of CSB must precede the updating (32nd) rising-edge of SCLK, meeting the t_{CSA} requirement.

Read mode operations will access the requested data on the 8th SCLK rising edge, and present the MSB of the requested data on the following SCLK falling edge, allowing the μ C to sample the data MSB on the 9th SCLK rising edge. Configuration, Status, and FIFO data are all available via normal mode read back sequences. If more than 32 SCLK rising edges are provided in a normal read sequence then the excess edges will be ignored and the device will read back zeros.

Table 6. R to R Decimation Delay in ms and FMSTR CLK vs. Register Settings, FCLK = 32.768Hz

FMSTR [1:0]	FMSTR FREQ IN FCLKs	FMSTR FREQ (Hz)	DECIMATION	RTOR TIME RESOLUTION (ms)	DELAY IN R TO R DECIMATION	
					IN FMSTR CLKs	IN ms
00	FCLK	32,768	256	7.8125	3370	102.844
01	FCLK x 625/640	32,000	256	8.0	3370	105.313
10	FCLK x 625/640	32,000	256	8.0	3370	105.313
11	FCLK x 640/656	31,968.78	256	8.0078	3370	105.415

If accessing the STATUS register or the ECG FIFO memories, all interrupt updates will be made and the internal FIFO read pointer will be incremented in response to the 30th SCLK rising edge, allowing for internal synchronization operations to occur. See the data tag structures used within each FIFO for means of detecting end-of-file (EOF) samples, invalid (empty samples) and other aides for efficiently using and managing normal mode read back operations.

Burst Mode Read Sequence

The MAX30003 provides commands to read back the ECG FIFO memory in a burst mode to increase data transfer efficiency. Burst mode uses different register addresses than the normal read sequence register addresses. The first 32 SCLK cycles operate exactly as described for the normal mode. If the μ C

continues to provide SCLK edges beyond the 32nd rising edge, the MSB of the next available FIFO word will be presented on the next falling SCLK edge, allowing the μ C to sample the MSB of the next word on the 33rd SCLK rising edge. Any affected interrupts and/or FIFO read pointers will be incremented in response to the $(30+n \times 24)$ th SCLK rising edge where n is an integer starting at 0. (i.e., on the 30th, 54th, and 78th SCLK rising-edges for a three-word, burst-mode transfer).

This mode of operation will continue for every 24 cycle sub frame, as long as there is valid data in the FIFO. See the data tag structures used within each FIFO for means of detecting end-of-file (EOF) samples, invalid (empty samples) and other aides for efficiently using and managing burst mode read back operations.

There is no burst mode equivalent in write mode.

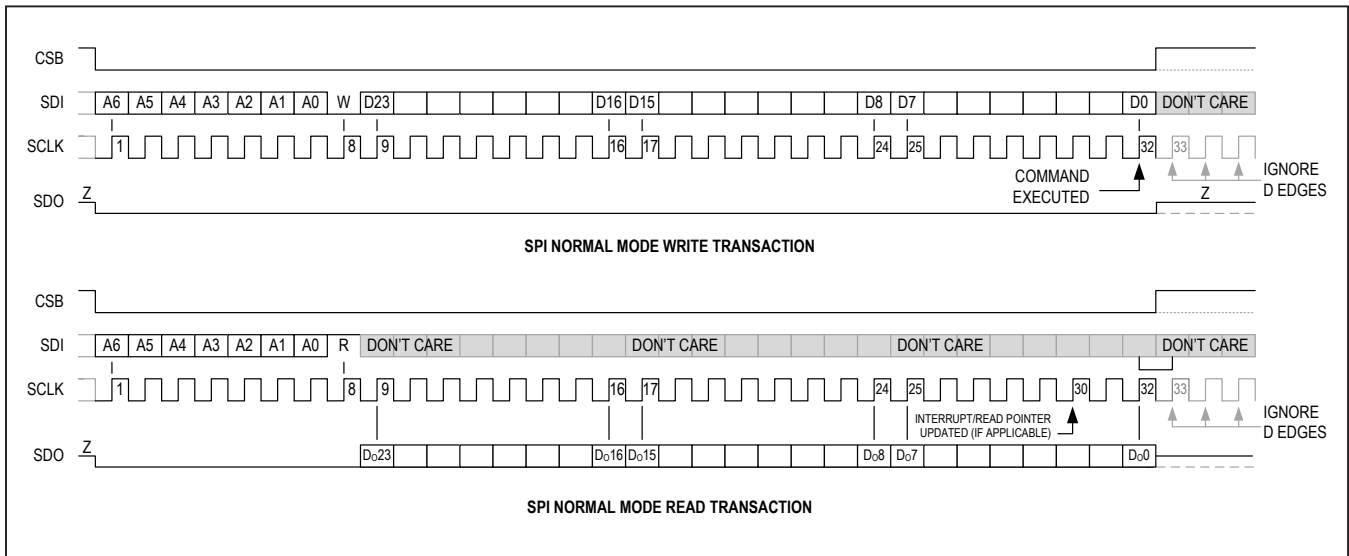

Figure 8. SPI Normal Mode Transaction Diagrams

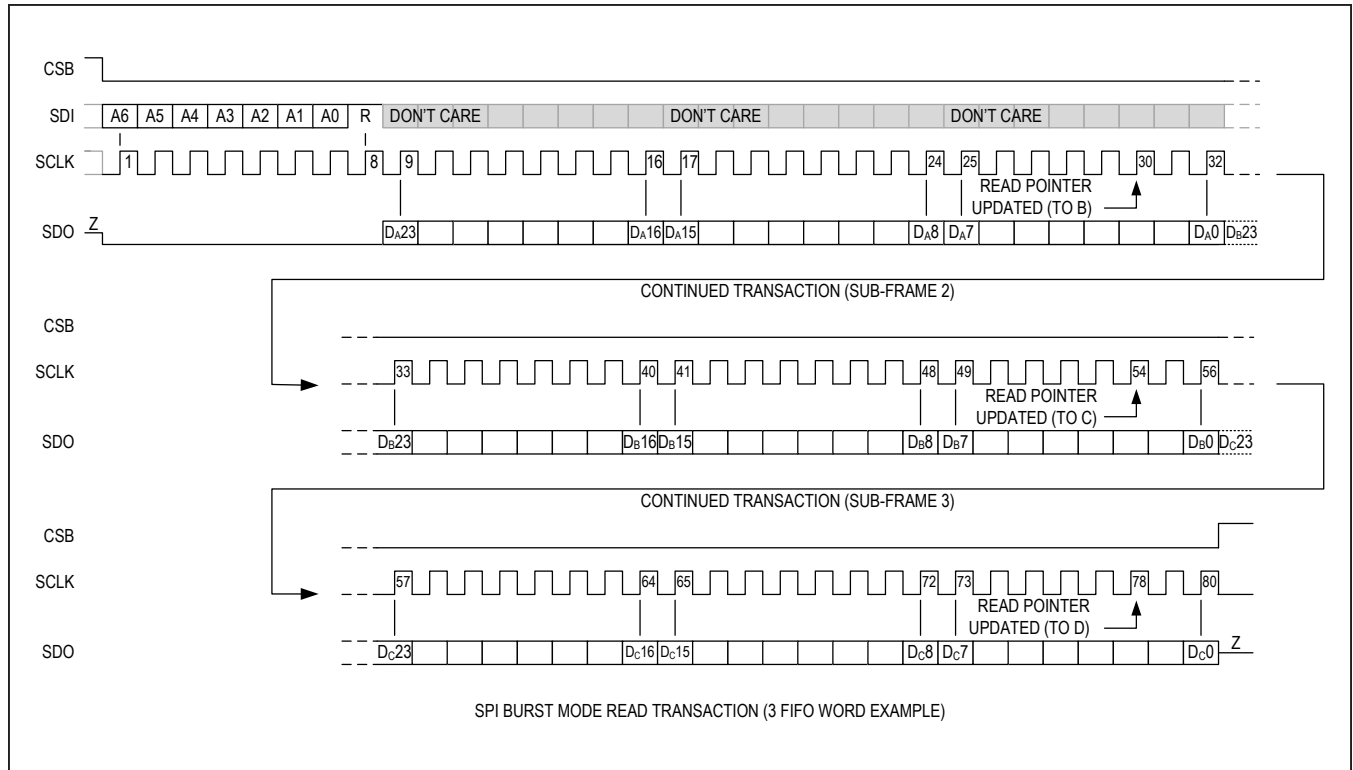

Figure 9. SPI Burst Mode Read Transactions Diagrams

User Command and Register Map

REG [6:0]	R/W MODE	NAME	DATA INDEX (DINDEX)												
			23 / 15 / 7	22 / 14 / 6	21 / 13 / 5	20 / 12 / 4	19 / 11 / 3	18 / 10 / 2	17 / 9 / 1	16 / 8 / 0					
0x00	R/W	NO-OP	x/x/x	x/x/x	x/x/x	x/x/x	x/x/x	x/x/x	x/x/x	x/x/x	x/x/x	x/x/x	x/x/x		
0x01	R	STATUS	EINT	EOVF	FSTINT	DCLOFFINT	DCLOFFINT	LONINT	RRINT	LOFF_PL	LOFF_NH	SAMP	PLLINT		
0x02	R/W	EN_INT EN_INT2	0	0	x	x	EN_EOVF	LOFF_PH	RRINT	LOFF_PL	LOFF_NH	SAMP	PLLINT		
0x03			EN_EINT	EN_EOVF	EN_FSTINT	EN_DCLOFFINT	x	x	EN_SAMP	EN_PLINT	INTB_TYPE[1:0]				
			x	x	x	x	x	x	x	x	x	x	x	x	
0x04	R/W	MNGR_INT	EFIT[4:0]												
			x	x	x	x	x	x	x	x	x	x	x		
0x05	R/W	MNGR_DYN	x	CLR_FAST	CLR_RRINT[1:0]	x	x	FAST_TH[5:0]	CLR_SAMP	SAMP_IT[3:0]					
			x	x	x	x	x	x	x	x	x	x			
0x08	W	SW_RST	Data Required for Execution = 0x0000000												
0x09	W	SYNCH	Data Required for Execution = 0x0000000												
0x0A	W	FIFO_RST	Data Required for Execution = 0x0000000												
0x0F	R	INFO	0	1	0	1	REV_ID[3:0]								
			x	x	1	1	x	x	x	x	x	x	x		
0x10	R/W	CNFG_GEN	x	x	x	FMSTR[1:0]	EN_ECG	IPOL	IMAG[2:0]						
			x	x	EN_DCLOFF[1:0]	EN_RBIAS[1:0]	RBIASV[1:0]	RBIASP	RBIASN						
			VTH[1:0]												

User Command and Register Map (continued)

REG [6:0]	R/W MODE	NAME	DATA INDEX (DINDEX)												
			23 / 15 / 7	22 / 14 / 6	21 / 13 / 5	20 / 12 / 4	19 / 11 / 3	18 / 10 / 2	17 / 9 / 1	16 / 8 / 0					
0x12	R/W	CNFG_CAL	x	EN_VCAL	VMODE	VMAG	x	x	x	FIFTY			THIGH[10:8]		
			THIGH[7:0]												
0x14	R/W	CNFG_EMUX	POL	x	OPENP	OPENN	CALP_SEL[1:0]	CALN_SEL[1:0]							
			x	x	x	x	x	x	x	x	x	x	x	x	
0x15	R/W	CNFG_ECG	RATE[1:0]		x		x	x	x	GAIN[1:0]					
			x	DHPF	DLPF[1:0]		x	x	x	x	x	x	x	x	
0x1D	R/W	CNFG_RTOR1	WNDW[3:0]			PAVG[1:0]			RGAIN[3:0]			PTSF[3:0]			
			x	x	x	x	x	x	x	x	x	x	x	x	
0x1E	R/W	CNFG_RTOR2	x	x		RAVG[1:0]			HOFF[5:0]			RHSF[2:0]			
			x	x	x	x	x	x	x	x	x	x	x	x	
0x20	R+	ECG_FIFO_BURST	ECG FIFO Burst Mode Read Back												
0x21	R	ECG_FIFO	ECG FIFO Normal Mode Read Back												
0x25	R	RTOR	R to R Interval Register Read Back												
0x7F	R/W	NO-OP	x/x/x	x/x/x	x/x/x	x/x/x	x/x/x	x/x/x	x/x/x	x/x/x	x/x/x	x/x/x	x/x/x	x/x/x	

Register Descriptions

NO_OP (0x00 and 0x7F) Registers

No Operation (NO_OP) registers are read-write registers that have no internal effect on the device. If these registers are read back, DOUT remains zero for the entire SPI transaction. Any attempt to write to these registers is ignored without impact to internal operation.

STATUS (0x01) Register

STATUS is a read-only register that provides a comprehensive overview of the current status of the device. The first two bytes indicate the state of all interrupt terms (regardless of whether interrupts are enabled in registers EN_INT (0x02) or EN_INT2 (0x03)). All interrupt terms are active high. The last byte includes detailed status information for conditions associated with the interrupt terms.

Table 7. STATUS (0x01) Register Map

REG	NAME	R/W	23 / 15 / 7	22 / 14 / 6	21 / 13 / 5	20 / 12 / 4	19 / 11 / 3	18 / 10 / 2	17 / 9 / 1	16 / 8 / 0
0x01	STATUS	R	EINT	EOVF	FSTINT	DCLOFF INT	x	x	x	x
			x	x	x	x	LONINT	RRINT	SAMP	PLLINT
			x	x	x	x	LDOFF_ PH	LDOFF_ PL	LDOFF_ NH	LDOFF_ NL

Table 8. Status (0x01) Register Meaning

INDEX	NAME	MEANING
D[23]	EINT	ECG FIFO Interrupt. Indicates that ECG records meeting/exceeding the ECG FIFO Interrupt Threshold (EFIT) are available for readback. Remains active until ECG FIFO is read back to the extent required to clear the EFIT condition.
D[22]	EOVF	ECG FIFO Overflow. Indicates that the ECG FIFO has overflowed and the data record has been corrupted. Remains active until a FIFO Reset (recommended) or SYNCH operation is issued.
D[21]	FSTINT	ECG Fast Recovery Mode. Issued when the ECG Fast Recovery Mode is engaged (either manually or automatically). Status and Interrupt Clear behavior is defined by CLR_FAST, see MNGR_INT for details.
D[20]	DCLOFFINT	DC Lead-Off Detection Interrupt. Indicates that the MAX30003 has determined it is in an ECG leads off condition (as selected in CNFG_GEN) for more than 115ms. Remains active as long as the leads-off condition persists, then held until cleared by STATUS read back (32nd SCLK).

Table 8. Status (0x01) Register Meaning (continued)

INDEX	NAME	MEANING
D[11]	LONINT	Ultra-Low Power (ULP) Leads-On Detection Interrupt. Indicates that the MAX30003 has determined it is in a leads-on condition (as selected in CNFG_GEN). LONINT is asserted whenever EN_ULP_LON[1:0] in register CNFG_GEN is set to either 0b01 or 0b10 to indicate that the ULP leads on detection mode has been enabled. The STATUS register has to be read back once after ULP leads on detection mode has been activated to clear LONINT and enable leads on detection. LONINT remains active while the leads-on condition persists, then held until cleared by STATUS read back (32nd SCLK).
D[10]	RRINT	ECG R to R Detector R Event Interrupt. Issued when the R to R detector has identified a new R event. Clear behavior is defined by CLR_RRINT[1:0]; see MNGR_INT for details.
D[9]	SAMP	Sample Synchronization Pulse. Issued on the ECG base-rate sampling instant, for use in assisting μ C monitoring and synchronizing other peripheral operations and data, generally recommended for use as a dedicated interrupt. Frequency is selected by SAMP_IT[1:0], see MNGR_INT for details. Clear behavior is defined by CLR_SAMP, see MNGR_INT for details.
D[8]	PLLINT	PLL Unlocked Interrupt. Indicates that the PLL has not yet achieved or has lost its phase lock. PLLINT will only be asserted when the PLL is powered up and active (ECG and/or BIOZ Channel enabled). Remains asserted while the PLL unlocked condition persists, then held until cleared by STATUS read back (32nd SCLK).
D[3]	LDOFF_PH	DC Lead Off Detection Detailed Status. Indicates that the MAX30003 has determined (as selected by CNFG_GEN): ECGP is above the high threshold (V_{THH}), ECGP is below the low threshold (V_{THL}), ECGN is above the high threshold (V_{THH}), ECGN is below the low threshold (V_{THL}), respectively. Remains active as long as the leads-off detection is active and the leads-off condition persists, then held until cleared by STATUS read back (32nd SCLK). LDOFF_PH to LDOFF_NL are detailed status bits that are asserted at the same time as DCLOFFINT.
D[2]	LDOFF_PL	
D[1]	LDOFF_NH	
D[0]	LDOFF_NL	

EN_INT (0x02) and EN_INT2 (0x03) Registers

EN_INT and EN_INT2 are read/write registers that govern the operation of the INTB output and INT2B output, respectively. The first two bytes indicate which interrupt input terms are included in the interrupt output OR term (ex. a one in an EN_INT register indicates that the corresponding input term is included in the INTB interrupt output OR term). See the STATUS register for detailed descriptions of the interrupt terms. The power-on reset state of all EN_INT terms is 0 (ignored by INT).

EN_INT and EN_INT2 can also be used to mask persistent interrupt conditions in order to perform other interrupt-driven operations until the persistent conditions are resolved.

INTB_TYPE[1:0] allows the user to select between a CMOS or an open-drain NMOS mode INTB output. If using open-drain mode, an option for an internal 125kΩ pullup resistor is also offered.

All INTB and INT2B types are active-low (INTB low indicates the device requires servicing by the μC); however, the open-drain mode allows the INTB line to be shared with other devices in a wired-or configuration.

In general, it is suggested that INT2B be used to support specialized/dedicated interrupts of use in specific applications, such as the self-clearing versions of SAMP or RRINT.

Table 9. EN_INT (0x02) and EN_INT2 (0x03) Register Maps

REG	NAME	R/W	23 / 15 / 7	22 / 14 / 6	21 / 13 / 5	20 / 12 / 4	19 / 11 / 3	18 / 10 / 2	17 / 9 / 1	16 / 8 / 0
0x02 0x03	EN_INT EN_INT2	R/W	EN_EINT	EN_EOVF	EN_FSTINT	EN_DCL OFFINT	x	x	x	x
			x	x	x	x	EN_ LONINT	EN_ RRINT	EN_ SAMP	EN_ PLLINT
			x	x	x	x	x	x	INTB_TYPE[1:0]	

Table 10. EN_INT (0x02 and 0x03) Register Meaning

INDEX	NAME	DEFAULT	FUNCTION
D[23:20] D[11:8]	EN_EINT EN_EOVF EN_FSTINT EN_DCLOFFINT EN_LONINT EN_RRINT EN_SAMP EN_PLLINT	0x0000	Interrupt Enables for interrupt terms in STATUS[23:8] 0 = Individual interrupt term is not included in the interrupt OR term 1 = Individual interrupt term is included in the interrupt OR term
D[1:0]	INTB_TYPE[1:0]	11	INTB Port Type (EN_INT Selections) 00 = Disabled (Three-state) 01 = CMOS Driver 10 = Open-Drain NMOS Driver 11 = Open-Drain NMOS Driver with Internal 125kΩ Pullup Resistance
		11	INT2B Port Type (EN_INT2 Selections) 00 = Disabled (three-state) 01 = CMOS Driver 10 = Open-Drain nMOS Driver 11 = Open-Drain nMOS Driver with Internal 125kΩ Pullup Resistance

MNGR_INT (0x04)

MNGR_INT is a read/write register that manages the operation of the configurable interrupt bits in response to ECG FIFO conditions (see the STATUS register and ECG

FIFO descriptions for more details). Finally, this register contains the configuration bits supporting the sample synchronization pulse (SAMP) and RTOR heart rate detection interrupt (RRINT).

Table 11. MNGR_INT (0x04) Register Map

REG	NAME	R/W	23 / 15 / 7	22 / 14 / 6	21 / 13 / 5	20 / 12 / 4	19 / 11 / 3	18 / 10 / 2	17 / 9 / 1	16 / 8 / 0	
0x04	MNGR_INT	R/W	EFIT[4:0]						x	x	x
			x	x	x	x	x	x	x	x	
			x	CLR_FAST	CLR_RRINT[1:0]	x	CLR_SAMP	SAMP_IT[1:0]			

Table 12. MNGR_INT (0x04) Register Functionality

INDEX	NAME	DEFAULT	FUNCTION
D[23:19]	EFIT[4:0]	01111	ECG FIFO Interrupt Threshold (issues EINT based on number of unread FIFO records) 00000 to 11111 = 1 to 32, respectively (i.e. EFIT[4:0]+1 unread records)
D[6]	CLR_FAST	0	FAST MODE Interrupt Clear Behavior: 0 = FSTINT remains active until the FAST mode is disengaged (manually or automatically), then held until cleared by STATUS read back (32nd SCLK). 1 = FSTINT remains active until cleared by STATUS read back (32nd SCLK), even if the MAX30003 remains in FAST recovery mode. Once cleared, FSTINT will not be re-asserted until FAST mode is exited and re-entered, either manually or automatically.
D[5:4]	CLR_RRINT[1:0]	00	RTOR R Detect Interrupt (RRINT) Clear Behavior: 00 = Clear RRINT on STATUS Register Read Back 01 = Clear RRINT on RTOR Register Read Back 10 = Self-Clear RRINT after one ECG data rate cycle, approximately 2ms to 8ms 11 = Reserved. Do not use.
D[2]	CLR_SAMP	1	Sample Synchronization Pulse (SAMP) Clear Behavior: 0 = Clear SAMP on STATUS Register Read Back (recommended for debug/evaluation only). 1 = Self-clear SAMP after approximately one-fourth of one data rate cycle.
D[1:0]	SAMP_IT[1:0]	00	Sample Synchronization Pulse (SAMP) Frequency 00 = issued every sample instant 01 = issued every 2nd sample instant 10 = issued every 4th sample instant 11 = issued every 16th sample instant

MNGR_DYN (0x05)

MNGR_DYN is a read/write register that manages the settings of any general/dynamic modes within the device. The ECG Fast Recovery modes and thresholds are managed here. Unlike many CNFG registers, changes to dynamic modes do not impact FIFO operations or require a SYNCH operation (though the affected circuits may require time to settle, resulting in invalid/corrupted FIFO output voltage information during the settling interval).

SW_RST (0x08)

SW_RST (Software Reset) is a write-only register/command that resets the MAX30003 to its original default conditions at the end of the SPI SW_RST transaction (i.e. the 32nd SCLK rising edge). Execution occurs only if DIN[23:0] = 0x000000. The effect of a SW_RST is identical to power-cycling the device.

Table 13. MNGR_DYN (0x05) Register Map

REG	NAME	R/W	23 / 15 / 7	22 / 14 / 6	21 / 13 / 5	20 / 12 / 4	19 / 11 / 3	18 / 10 / 2	17 / 9 / 1	16 / 8 / 0
0x05	MNGR_DYN	R/W	FAST[1:0]		FAST_TH[5:0]					
			x	x	x	x	x	x	x	x
			x	x	x	x	x	x	x	x

Table 14. MNGR_DYN (0x05) Register Functionality

INDEX	NAME	DEFAULT	FUNCTION
D[23:22]	FAST[1:0]	00	ECG Channel Fast Recovery Mode Selection (ECG High Pass Filter Bypass): 00 = Normal Mode (Fast Recovery Mode Disabled) 01 = Manual Fast Recovery Mode Enable (remains active until disabled) 10 = Automatic Fast Recovery Mode Enable (Fast Recovery automatically activated when/while ECG outputs are saturated, using FAST_TH). 11 = Reserved. Do not use.
D[21:16]	FAST_TH[5:0]	0x3F	Automatic Fast Recovery Threshold: If FAST[1:0] = 10 and the output of an ECG measurement exceeds the symmetric thresholds defined by 2048*FAST_TH for more than 125ms, the Fast Recovery mode will be automatically engaged and remain active for 500ms. For example, the default value (FAST_TH = 0x3F) corresponds to an ECG output upper threshold of 0x1F800, and an ECG output lower threshold of 0x20800.

Table 15. SW_RST (080x) Register Map

REG	NAME	R/W	23 / 15 / 7	22 / 14 / 6	21 / 13 / 5	20 / 12 / 4	19 / 11 / 3	18 / 10 / 2	17 / 9 / 1	16 / 8 / 0
0x08	SW_RST	R/W	D[23:16] = 0x00							
			D[15:8] = 0x00							
			D[7:0] = 0x00							

SYNCH (0x09)

SYNCH (Synchronize) is a write-only register/command that begins new ECG operations and recording, beginning on the internal MSTR clock edge following the end of the SPI SYNCH transaction (i.e. the 32nd SCLK rising edge). Execution occurs only if $DIN[23:0] = 0x000000$. In addition to resetting and synchronizing the operations of any active ECG and RtoR circuitry, SYNCH will also reset and clear the FIFO memories and the DSP filters (to midscale), allowing the user to effectively set the “Time Zero” for the FIFO records. No configuration settings are impacted. For best results, users should wait until the PLL has achieved lock before synchronizing if the CNFG_GEN settings have been altered.

Once the device is initially powered up, it will need to be fully configured prior to launching recording operations. Likewise, anytime a change to CNFG_GEN or CNFG_ECG registers are made there may be discontinuities in the ECG record and possibly changes to the size of the time steps recorded in the FIFOs. The SYNCH command provides a means to restart operations cleanly following any such disturbances.

During multi-channel operations, if a FIFO overflow event occurs and a portion of the record is lost, it is recommended to use the SYNCH command to recover and restart the recording (avoiding issues with missing data in one or more channel records). Note that the two channel records cannot be directly synchronized within the device, due to significant differences in group delays, depending on filter selections—alignment of the records will have to be done externally.

FIFO_RST (0x0A)

FIFO_RST (FIFO Reset) is a write-only register/command that begins a new ECG recording by resetting the FIFO memories and resuming the record with the next available ECG data. Execution occurs only if $DIN[23:0]=0x000000$. Unlike the SYNCH command, the operations of any active ECG and R-to-R circuitry are not impacted by FIFO_RST, so no settling/recovery transients apply. FIFO_RST can also be used to quickly recover from a FIFO overflow state (recommended for single-channel use, see above).

Table 16. SYNCH (0x09) Register Map

REG	NAME	R/W	23 / 15 / 7	22 / 14 / 6	21 / 13 / 5	20 / 12 / 4	19 / 11 / 3	18 / 10 / 2	17 / 9 / 1	16 / 8 / 0
0x09	SYNCH	R/W	D[23:16] = 0x00							
			D[15:8] = 0x00							
			D[7:0] = 0x00							

Table 17. FIFO_RST (0x0A) Register Map

REG	NAME	R/W	23 / 15 / 7	22 / 14 / 6	21 / 13 / 5	20 / 12 / 4	19 / 11 / 3	18 / 10 / 2	17 / 9 / 1	16 / 8 / 0
0x0A	FIFO_RST	R/W	D[23:16] = 0x00							
			D[15:8] = 0x00							
			D[7:0] = 0x00							

INFO (0x0F)

INFO is a read-only register that provides information about the MAX30003. The first nibble contains an alternating bit pattern to aid in interface verification. The second nibble contains the revision ID. The third nibble includes part ID information. The final 3 nibbles contain a serial number for Maxim internal use—note that individual units are not given unique serial numbers, and these bits should not be used as serial numbers for end products, though they may be useful during initial development efforts.

Note: due to internal initialization procedures, this command will not read-back valid data if it is the first command executed following either a power-cycle event, or a SW_RST event.

CNFG_GEN (0x10)

CNFG_GEN is a read/write register which governs general settings, most significantly the master clock rate for all internal timing operations. Anytime a change to CNFG_GEN is made, there may be discontinuities in the ECG record and possibly changes to the size of the time steps recorded in the FIFOs. The SYNCH command can be used to restore internal synchronization resulting from configuration changes. Note when EN_ECG is logic-low, the device is in one of two ultra-low power modes (determined by EN_ULP_LON).

Table 18. INFO (0x0F) Register Map

REG	NAME	R/W	23 / 15 / 7	22 / 14 / 6	21 / 13 / 5	20 / 12 / 4	19 / 11 / 3	18 / 10 / 2	17 / 9 / 1	16 / 8 / 0	
0x0F	FIFO_RST	R/W	0	1	0	1	REV_ID[3:0]				
			x	x	1	1	x	x	x	x	
			x	x	x	x	x	x	x	x	

Table 19. INFO (0x0F) Register Meaning

INDEX	NAME	MEANING
D[19:16]	REV_ID[3:0]	Revision ID

Table 20. CNFG_GEN (0x10) Register Map

REG	NAME	R/W	23 / 15 / 7	22 / 14 / 6	21 / 13 / 5	20 / 12 / 4	19 / 11 / 3	18 / 10 / 2	17 / 9 / 1	16 / 8 / 0
0x10	CNFG_GEN	R/W	EN_ULP_LON[1:0]		FMSTR[1:0]		EN_ECG	x	x	x
			x	x	EN_DCLOFF[1:0]	IPOL	IMAG[2:0]			
			VTH[1:0]		EN_RBIAS[1:0]	RBIASV[1:0]		RBIASP	RBIASN	

Table 21. CNFG_GEN (0x10) Register Functionality

INDEX	NAME	DEFAULT	FUNCTION
D[23:22]	EN_ULP_LON [1:0]	00	Ultra-Low Power Lead-On Detection Enable 00 = ULP Lead-On Detection disabled 01 = ECG ULP Lead-On Detection enabled 10 = Reserved. Do not use. 11 = Reserved. Do not use. ULP mode is only active when the ECG channel is powered down/disabled.
D[21:20]	FMSTR[1:0]	00	Master Clock Frequency. Selects the Master Clock Frequency (FMSTR), and Timing Resolution (T _{RES}), which also determines the ECG and CAL timing characteristics. These are generated from FCLK, which is always 32.768Khz. 00 = FMSTR = 32768Hz, T _{RES} = 15.26μs (512Hz ECG progressions) 01 = FMSTR = 32000Hz, T _{RES} = 15.63μs (500Hz ECG progressions) 10 = FMSTR = 32000Hz, T _{RES} = 15.63μs (200Hz ECG progressions) 11 = FMSTR = 31968.78Hz, T _{RES} = 15.64μs (199.8049Hz ECG progressions)
D[19]	EN_ECG	0	ECG Channel Enable 0 = ECG Channel disabled 1 = ECG Channel enabled Note: The ECG channel must be enabled to allow R-to-R operation.
D[13:12]	EN_DCLOFF	00	DC Lead-Off Detection Enable 00 = DC Lead-Off Detection disabled 01 = DCLOFF Detection applied to the ECGP/N pins 10 = Reserved. Do not use. 11 = Reserved. Do not use. DC Method, requires active selected channel, enables DCLOFF interrupt and status bit behavior. Uses current sources and comparator thresholds set below.
D[11]	DCLOFF_ IPOL	0	DC Lead-Off Current Polarity (if current sources are enabled/connected) 0 = ECGP - Pullup ECGN – Pulldown 1 = ECGP - Pulldown ECGN – Pullup
D[10:8]	DCLOFF_ IMAG[2:0]	000	DC Lead-Off Current Magnitude Selection 000 = 0nA (Disable and Disconnect Current Sources) 001 = 5nA 010 = 10nA 011 = 20nA 100 = 50nA 101 = 100nA 110 = Reserved. Do not use. 111 = Reserved. Do not use.
D[7:6]	DCLOFF_ VTH[1:0]	00	DC Lead-Off Voltage Threshold Selection 00 = V _{MID} ± 300mV 01 = V _{MID} ± 400mV 10 = V _{MID} ± 450mV 11 = V _{MID} ± 500mV
D[5:4]	EN_RBIAS[1:0]	00	Enable and Select Resistive Lead Bias Mode 00 = Resistive Bias disabled 01 = ECG Resistive Bias enabled if EN_ECG is also enabled 10 = Reserved. Do not use. 11 = Reserved. Do not use. If EN_ECG is not asserted at the same time as prior to EN_RBIAS[1:0] being set to 01, then EN_RBIAS[1:0] will remain set to 00.

Table 21. CNFG_GEN (0x10) Register Functionality (continued)

INDEX	NAME	DEFAULT	FUNCTION
D[3:2]	RBIASV[1:0]	01	Resistive Bias Mode Value Selection 00 = $R_{BIAS} = 50M\Omega$ 01 = $R_{BIAS} = 100M\Omega$ 10 = $R_{BIAS} = 200M\Omega$ 11 = Reserved. Do not use.
D[1]	RBIASP	0	Enables Resistive Bias on Positive Input 0 = ECGP is not resistively connected to V_{MID} 1 = ECGP is connected to V_{MID} through a resistor (selected by RBIASV).
D[0]	RBIASN	0	Enables Resistive Bias on Negative Input 0 = ECGN is not resistively connected to V_{MID} 1 = ECGN is connected to V_{MID} through a resistor (selected by RBIASV).

Table 22 shows the ECG data rates that can be realized with various setting of FMSTR, along with RATE configuration bits available in the CNFG_ECG register. Note FMSTR also determines the timing resolution of the CAL waveform generator.

Table 22. Master Frequency Summary Table

FMSTR [1:0]	MASTER FREQUENCY (f_{MSTR}) (Hz)	ECG DATA RATES & RELATED TIMING (RATE SELECTIONS)		CALIBRATION TIMING RESOLUTION (CAL_RES) (μ s)
		ECG	RTOR	
		DATA RATE (sps)	TIMING RESOLUTION (RTOR_RES) (ms)	
00	32768	00 = 512 01 = 256 10 = 128	7.8125	30.52
01	32000	00 = 500 01 = 250 10 = 125	8.000	31.25
10	32000	10 = 200	8.000	31.25
11	31968.78	10 = 199.8049	8.008	31.28

CNFG_CAL (0x12)

CNFG_CAL is a read/write register that configures the operation, settings, and function of the Internal Calibration Voltage Sources (VCALP and VCALN). The output of the voltage sources can be routed to the ECG inputs through the channel input MUXes to facilitate end-to-end testing operations. Note if a VCAL source is applied to a connected device, it is recommended that the appropriate channel MUX switches be placed in the OPEN position.

Table 23. CNFG_CAL (0x12) Register Map

REG	NAME	R/W	23 / 15 / 7	22 / 14 / 6	21 / 13 / 5	20 / 12 / 4	19 / 11 / 3	18 / 10 / 2	17 / 9 / 1	16 / 8 / 0
0x12	CNFG_CAL	R/W	x	EN_VCAL	VMODE	VMAG	x	x	x	x
			x	FCAL[14:12]			FIFTY	THIGH[10:8]		
			THIGH[7:0]							

Table 24. CNFG_CAL (0x12) Register Functionality

INDEX	NAME	DEFAULT	FUNCTION
D[22]	EN_VCAL	0	Calibration Source (VCALP and VCALN) Enable 0 = Calibration sources and modes disabled 1 = Calibration sources and modes enabled
D[21]	VMODE	0	Calibration Source Mode Selection 0 = Unipolar, sources swing between $V_{MID} \pm V_{MAG}$ and V_{MID} 1 = Bipolar, sources swing between $V_{MID} + V_{MAG}$ and $V_{MID} - V_{MAG}$
D[20]	VMAG	0	Calibration Source Magnitude Selection (V_{MAG}) 0 = 0.25mV 1 = 0.50mV
D[14:12]	FCAL[2:0]	100	Calibration Source Frequency Selection (FCAL) 000 = $F_{MSTR}/128$ (Approximately 256Hz) 001 = $F_{MSTR}/512$ (Approximately 64Hz) 010 = $F_{MSTR}/2048$ (Approximately 16Hz) 011 = $F_{MSTR}/8192$ (Approximately 4Hz) 100 = $F_{MSTR}/2^{15}$ (Approximately 1Hz) 101 = $F_{MSTR}/2^{17}$ (Approximately 1/4Hz) 110 = $F_{MSTR}/2^{19}$ (Approximately 1/16Hz) 111 = $F_{MSTR}/2^{21}$ (Approximately 1/64Hz) Actual frequencies are determined by FMSTR selection (see CNFG_GEN for details), approximate frequencies are based on a 32768Hz clock ($F_{MSTR}[2:0] = 000$). TCAL = 1/FCAL.
D[11]	FIFTY	1	Calibration Source Duty Cycle Mode Selection 0 = Use CAL_THIGH to select time high for VCALP and VCALN 1 = THIGH = 50% (CAL_THIGH[10:0] are ignored)
D[10:0]	THIGH[10:0]	0x000	Calibration Source Time High Selection If FIFTY = 1, $t_{HIGH} = 50%$ (and THIGH[10:0] are ignored), otherwise THIGH = THIGH[10:0] x CAL_RES CAL_RES is determined by FMSTR selection (see CNFG_GEN for details); for example, if FMSTR[2:0] = 000, CAL_RES = 30.52 μ s.

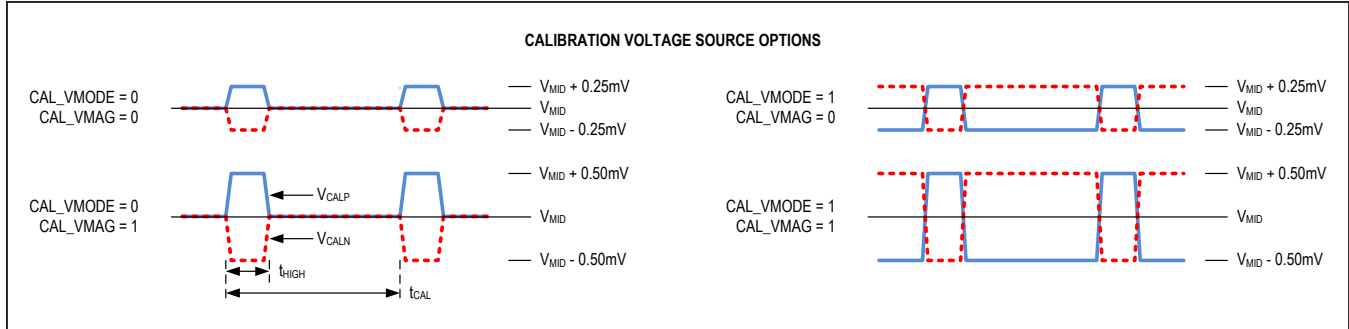

Figure 10. Calibration Voltage Source Options

CNFG_EMUX (0x14)

CNFG_EMUX is a read/write register which configures the operation, settings, and functionality of the Input Multiplexer associated with the ECG channel.

Table 25. CNFG_EMUX (0x14) Register Map

REG	NAME	R/W	23 / 15 / 7	22 / 14 / 6	21 / 13 / 5	20 / 12 / 4	19 / 11 / 3	18 / 10 / 2	17 / 9 / 1	16 / 8 / 0
0x14	CNFG_EMUX	R/W	POL	x	OPENP	OPENN	CALP_SEL[1:0]		CALN_SEL[1:0]	
			x	x	x	x	x	x	x	x
			x	x	x	x	x	x	x	x

Table 26. CNFG_EMUX (0x14) Register Functionality

INDEX	NAME	DEFAULT	FUNCTION
D[23]	POL	0	ECG Input Polarity Selection 0 = Non-inverted 1 = Inverted
D[21]	OPENP	1	Open the ECGP Input Switch (most often used for testing and calibration studies) 0 = ECGP is internally connected to the ECG AFE Channel 1 = ECGP is internally isolated from the ECG AFE Channel
D[20]	OPENN	1	Open the ECGN Input Switch (most often used for testing and calibration studies) 0 = ECGN is internally connected to the ECG AFE Channel 1 = ECGN is internally isolated from the ECG AFE Channel
D[19:18]	CALP_SEL[1:0]	00	ECGCP Calibration Selection 00 = No calibration signal applied 01 = Input is connected to V_MID 10 = Input is connected to V_CALP (only available if CAL_EN_VCAL = 1) 11 = Input is connected to V_CALN (only available if CAL_EN_VCAL = 1)
D[17:16]	CALN_SEL[1:0]	00	ECGNC Calibration Selection 00 = No calibration signal applied 01 = Input is connected to V_MID 10 = Input is connected to V_CALP (only available if CAL_EN_VCAL = 1) 11 = Input is connected to V_CALN (only available if CAL_EN_VCAL = 1)

CNFG_ECG (0x15)

CNFG_ECG is a read/write register which configures the operation, settings, and functionality of the ECG channel. Anytime a change to CNFG_ECG is made, there may be discontinuities in the ECG record and possibly changes to the size of the time steps recorded in the ECG FIFO. The SYNCH command can be used to restore internal synchronization resulting from configuration changes.

Table 27. CNFG_ECG (0x15) Register Map

REG	NAME	R/W	23 / 15 / 7	22 / 14 / 6	21 / 13 / 5	20 / 12 / 4	19 / 11 / 3	18 / 10 / 2	17 / 9 / 1	16 / 8 / 0
0x15	CNFG_ECG	R/W	RATE[1:0]		x	x	x	x	GAIN[1:0]	
			x	DHPF	DLPF[1:0]		x	x	x	x
			x	x	x	x	x	x	x	x

Table 28. CNFG_ECG (0x15) Register Functionality

INDEX	NAME	DEFAULT	FUNCTION
D[23:22]	RATE[1:0]	10	ECG Data Rate (also dependent on FMSTR selection, see CNFG_GEN Table 29):
			FMSTR = 00: f _{MSTR} = 32768Hz, t _{RES} = 15.26μs (512Hz ECG progressions) 00 = 512sps 01 = 256sps 10 = 128sps 11 = Reserved. Do not use.
			FMSTR = 01: f _{MSTR} = 32000Hz, t _{RES} = 15.63μs (500Hz ECG progressions) 00 = 500sps 01 = 250sps 10 = 125sps 11 = Reserved. Do not use.
			FMSTR = 10: f _{MSTR} = 32000Hz, t _{RES} = 15.63μs (200Hz ECG progressions) 00 = Reserved. Do not use. 01 = Reserved. Do not use. 10 = 200sps 11 = Reserved. Do not use.
D[17:16]	GAIN[1:0]	00	ECG Channel Gain Setting 00 = 20V/V 01 = 40V/V 10 = 80V/V 11 = 160V/V
			FMSTR = 11: f _{MSTR} = 31968Hz, t _{RES} = 15.64μs (199.8Hz ECG progressions) 00 = Reserved. Do not use. 01 = Reserved. Do not use. 10 = 199.8sps 11 = Reserved. Do not use.

Table 28. CNFG_ECG (0x15) Register Functionality (continued)

INDEX	NAME	DEFAULT	FUNCTION
D[14]	DHPF	1	ECG Channel Digital High-Pass Filter Cutoff Frequency 0 = Bypass (DC) 1 = 0.50Hz
D[13:12]	DLPF[1:0]	01	ECG Channel Digital Low-Pass Filter Cutoff Frequency 00 = Bypass (Decimation only, no FIR filter applied) 01 = approximately 40Hz (Except for 125 and 128sps settings) Note: See Table 33. 10 = approximately 100Hz (Available for 512, 256, 500, and 250sps ECG Rate selections only) 11 = approximately 150Hz (Available for 512 and 500sps ECG Rate selections only) Note: See Table 29. If an unsupported DLPF setting is specified, the 40Hz setting (DLPF[1:0] = 01) will be used internally; the CNFG_ECG register will continue to hold the value as written, but return the effective internal value when read back.

Table 29. Supported ECG_RATE and ECG_DLPF Options

CNFG_GEN FMSTR[1:0]	RATE[1:0] SAMPLE RATE (sps)	DLPF[1:0]/DIGITAL LPF CUTOFF			
		00	01 (Hz)	10 (Hz)	11 (Hz)
00 = 32768Hz	00 = 512	Bypass	40.96	102.4	153.6
	01 = 256	Bypass	40.96	102.4	40.96
	10 = 128	Bypass	28.35	28.35	28.35
01 = 32000Hz	00 = 500	Bypass	40.00	100.0	150.0
	01 = 250	Bypass	40.00	100.0	40.00
	10 = 125	Bypass	27.68	27.68	27.68
10 = 32000Hz	10 = 200	Bypass	40.00	40.00	40.00
11 = 31968Hz	10 = 199.8	Bypass	39.96	39.96	39.96

Note: Combinations shown in grey are unsupported and will be internally mapped to the default settings shown.

CNFG_RTOR1 and CNFG_RTOR2 (0x1D & 0x1E)

CNFG_RTOR is a two-part read/write register that configures the operation, settings, and function of the RTOR heart rate detection block. The first register contains algorithmic voltage gain and threshold parameters, the second contains algorithmic timing parameters.

Table 30. CNFG_RTOR and CNFG_RTOR2 (0x1D and 0x1E) Register Maps

REG	NAME	R/W	23 / 15 / 7	22 / 14 / 6	21 / 13 / 5	20 / 12 / 4	19 / 11 / 3	18 / 10 / 2	17 / 9 / 1	16 / 8 / 0
0x1D	CNFG_RTOR1	R/W	WNDW[3:0]				GAIN[3:0]			
			EN_RTOR	x	PAVG[1:0]		PTSF[3:0]			
			x	x	x	x	x	x	x	x
0x1E	CNFG_RTOR2	R/W	x	x	HOFF[5:0]					
			x	x	RAVG[1:0]		x	RHSF[2:0]		
			x	x	x	x	x	x	x	x

Table 31. CNFG_RTOR and CNFG_RTOR2 (0x1D and 0x1E) Register Functionality

INDEX	NAME	DEFAULT	FUNCTION
CNFG_RTOR1 (0x1D)			
D[23:20]	eWNDW[3:0]	0011	<p>This is the width of the averaging window, which adjusts the algorithm sensitivity to the width of the QRS complex. R to R Window Averaging (Window Width = RTOR_WNDW[3:0]*8ms) 0000 = 6 0001 = 8 0010 = 10 0011 = 12 (default = 96ms) 0100 = 14 0101 = 16 0110 = 18 0111 = 20 1000 = 22 1001 = 24 1010 = 26 1011 = 28 1100 = Reserved. Do not use. 1101 = Reserved. Do not use. 1110 = Reserved. Do not use. 1111 = Reserved. Do not use.</p>
D[19:16]	GAIN[3:0]	1111	<p>R to R Gain (where Gain = 2^GAIN[3:0], plus an auto-scale option). This is used to maximize the dynamic range of the algorithm. 0000 = 1 1000 = 256 0001 = 2 1001 = 512 0010 = 4 1010 = 1024 0011 = 8 1011 = 2048 0100 = 16 1100 = 4096 0101 = 32 1101 = 8192 0110 = 64 1110 = 16384 0111 = 128 1111 = Auto-Scale (default) In Auto-Scale mode, the initial gain is set to 64.</p>

Table 31. CNFG_RTOR and CNFG_RTOR2 (0x1D and 0x1E) Register Functionality (continued)

INDEX	NAME	DEFAULT	FUNCTION
D[15]	EN_RTOR	0	ECG RTOR Detection Enable 0 = RTOR Detection disabled 1 = RTOR Detection enabled if EN_ECG is also enabled.
D[13:12]	PAVG[1:0]	10	R to R Peak Averaging Weight Factor This is the weighting factor for the current RTOR peak observation vs. past peak observations when determining peak thresholds. Lower numbers weight current peaks more heavily. 00 = 2 01 = 4 10 = 8 (default) 11 = 16 Peak_Average(n) = $[\text{Peak}(n) + (\text{RTOR_PAVG}-1) \times \text{Peak_Average}(n-1)] / \text{RTOR_PAVG}$.
D[11:8]	PTSF[3:0]	0011	R to R Peak Threshold Scaling Factor This is the fraction of the Peak Average value used in the Threshold computation. Values of 1/16 to 16/16 are selected directly by $(\text{RTOR_PTSF}[3:0]+1)/16$, default is 4/16.
CNFG_RTOR2 (0x1E)D [21:16]	HOFF[5:0]	10_0000	R to R Minimum Hold Off This sets the absolute minimum interval used for the static portion of the Hold Off criteria. Values of 0 to 63 are supported, default is 32 $t_{\text{HOLD_OFF_MIN}} = \text{HOFF}[5:0] \times t_{\text{RTOR}}$, where t_{RTOR} is ~8ms, as determined by FMSTR[1:0] in the CNFG_GEN register. (representing approximately ¼ second). The R to R Hold Off qualification interval is $t_{\text{Hold_Off}} = \text{MAX}(t_{\text{Hold_Off_Min}}, t_{\text{Hold_Off_Dyn}})$ (see below).
D[13:12]	RAVG[1:0]	10	R to R Interval Averaging Weight Factor This is the weighting factor for the current RtoR interval observation vs. the past interval observations when determining dynamic holdoff criteria. Lower numbers weight current intervals more heavily. 00 = 2 01 = 4 10 = 8 (default) 11 = 16 $\text{Interval_Average}(n) = [\text{Interval}(n) + (\text{RAVG}-1) \times \text{Interval_Average}(n-1)] / \text{RAVG}$.
D[10:8]	RHSF[2:0]	100	R to R Interval Hold Off Scaling Factor This is the fraction of the RtoR average interval used for the dynamic portion of the holdoff criteria ($t_{\text{HOLD_OFFDYN}}$). Values of 0/8 to 7/8 are selected directly by $\text{RTOR_RHSF}[3:0]/8$, default is 4/8. If 000 (0/8) is selected, then no dynamic factor is used and the holdoff criteria is determined by HOFF[5:0] only (see above).

FIFO Memory Description

The device provides FIFO memory for ECG information. Single memory registers are also supported for heart rate detection output data (RTOR). The operation of these FIFO memories and registers is detailed in the following sections.

[Table 32](#) summarizes the method of access and data structure within the FIFO memory.

ECG FIFO Memory (32 Words x 24 Bits)

The ECG FIFO memory is a standard circular FIFO consisting of 32 words, each with 24 bits of information.

The ECG FIFO is independently managed by internal read and write pointers. The read pointer is updated in response to the 32nd SCLK rising edge in a normal mode read back transaction and on the (32+n x 24)th SCLK rising edge(s) in a burst mode transaction. Once a FIFO sample is marked as read, it cannot be accessed again.

The write pointer is governed internally. To aide data management and reduce μC overhead, the device provides a user-programmable ECG FIFO Interrupt Threshold (EFIT) governing the ECG Interrupt term (EINT). This threshold can be programmed with values from 1 to 32, representing the number of unread ECG FIFO entries required before the EINT term will be asserted, alerting the μC that there is a significant amount of data in the ECG FIFO ready for read back (see [MNGR_INT \(0x04\)](#) for details).

If the write pointer ever traverses the entire FIFO array and catches up to the read pointer (due to failure of the μC to read/maintain FIFO data), a FIFO overflow will occur and data will be corrupted. The EOVF STATUS and tag bits will indicate this condition and the FIFO should be cleared before continuing measurements using either a SYNCH or FIFO_RST command—note overflow events will result in the loss of samples and thus timing information, so these conditions should not occur in well-designed applications.

Table 32. FIFO Memory Access and Data Structure Summary

CMD	FIFO & MODE	DATA STRUCTURE (D _O [23:0])																									
		23	22	21	20	19	18	17	16	15	14	13	12	11	10	9	8	7	6	5	4	3	2	1	0		
0x20	ECG Burst	ECG Sample Voltage Data [17:0]																		ETAG [2:0]		PTAG [2:0]					
0x21	ECG	ECG Sample Voltage Data [17:0]																		ETAG [2:0]		PTAG [2:0]					
		23	22	21	20	19	18	17	16	15	14	13	12	11	10	9	8	7	6	5	4	3	2	1	0		
0x25	RTOR	RTOR Interval Timing Data [13:0]													0	0	0	0	0	0	0	0	0	0	0	0	0

ECG FIFO Data Structure

The data portion of the word contains the 18 Bit ECG voltage information measured at the requested sample rate in

left justified two's complement format. The remaining six bits of data hold important data tagging information (see details in [Table 33](#)).

Table 33. ECG FIFO Data Tags (ETAG[2:0] = DO[5:3])

ETAG [2:0]	MEANING	DETAILED DESCRIPTION	RECOMMENDED USER ACTION	DATA VALID	TIME VALID
000	Valid Sample	This is a valid FIFO sample.	Log sample into ECG record and increment the time step. Continue to gather data from the ECG FIFO.	Yes	Yes
001	Fast Mode Sample	This sample was taken while the ECG channel was in a FAST recovery mode. The voltage information is not valid, but the sample represents a valid time step.	Discard, note, or post-process this voltage sample, but increment the time base. Continue to gather data from the ECG FIFO.	No	Yes
010	Last Valid Sample (EOF)	This is a valid FIFO sample, but this is the last sample currently available in the FIFO (End of File indicator).	Log sample into ECG record and increment the time step. Suspend read back operations on the ECG FIFO until more samples are available.	Yes	Yes
011	Last Fast Mode Sample (EOF)	See above (ETAG=001), but in addition, this is the last sample currently available in the FIFO (End of File indicator).	Discard, note, or post-process this voltage sample, but increment the time base. Suspend read back operations on the ECG FIFO until more samples are available.	No	Yes
10x	Unused			--	--
110	FIFO Empty (Exception)	This is an invalid sample provided in response to an SPI request to read an empty FIFO.	Discard this sample, without incrementing the time base. Suspend read back operations on this FIFO until more samples are available.	No	No
111	FIFO Overflow (Exception)	The FIFO has been allowed to overflow – the data is corrupted.	Issue a FIFO_RST command to clear the FIFOs or re-SYNCH if necessary. Note the corresponding halt and resumption in ECG/BIOZ time/voltage records.	No	No

ECG Data Tags (ETAG)

Three bits in the sample record are used as a ECG data tag (ETAG[2:0] = DO[5:3]). This section outlines the meaning of the various data tags used in the ECG FIFO and recommended handling within the continuous ECG record.

VALID: ETAG = 000 indicates the ECG data for this sample represents both a valid voltage and time step in the ECG record.

FAST: ETAG = 001 indicates the ECG data for this sample was taken in the FAST settling mode and that the voltage information in the sample should be treated as transient and invalid. Note that while the voltage data is invalid, samples of this type do represent valid time steps in the ECG record.

VALID EOF: ETAG = 010 indicates the ECG data for this sample represents both a valid voltage and time step in the ECG record, and that this is the last sample currently available in the ECG FIFO (End-of-File, EOF). The μC should wait until further samples are available before requesting more data from the ECG FIFO.

FAST EOF: ETAG = 011 indicates the ECG data for this sample was taken in the FAST settling mode and that the voltage information in the sample should be treated as transient and invalid. Note that while the voltage data is invalid, samples of this type do represent valid time steps in the ECG record. In addition, this is the last sample currently available in the ECG FIFO (End-of-File, EOF). The μC should wait until further samples are available before requesting more data from the ECG FIFO.

EMPTY: ETAG = 110 is appended to any requested read back data from an empty ECG FIFO. The presence of this tag alerts the user that this FIFO data does not represent a valid sample or time step. Note that if handled properly by the μC , an occurrence of an empty tag will not compromise the integrity of a continuous ECG record – this tag only indicates that the read back request was either premature or unnecessary.

OVERFLOW: ETAG = 111 indicates that the ECG FIFO has overflowed and that there are interruptions or missing data in the sample records. The ECG Overflow (EOVF) bit is also included in the STATUS register. A FIFO_RESET is required to resolve this situation, effectively clearing the FIFO so that valid sampling going forward is assured. Depending on the application, it may also be necessary to resynchronize the MAX30003 internal channel operations to move forward with valid recordings, the SYNCH command can perform this function while also resetting the FIFO memories

RTOR Interval Memory Register (1 Word x 24 Bits)

The RTOR Interval (RTOR) memory register is a single read-only register consisting of 14 bits of timing interval information, left justified (and 8 unused bits, set to zero).

The RTOR register stores the time interval between the last two R events, as identified by the RTOR detection circuitry, which operates on the ECG output data. Each LSB in the RTOR register is approximately equal to 8ms (CNFG_GEN for exact figures). The resulting 14 bit storage interval can thus be approximately 130 seconds in length, again depending on device settings.

Each time the RTOR detector identifies a new R event, the RTOR register is updated, and the RRINT interrupt term is asserted (see STATUS register for details).

Users wishing to log heart rate based on RTOR register data should set CLR_RRINT equals 01 in the MNGR_INT register. This will clear the RRINT interrupt term after the RTOR register has been read back, preparing the device for identification of the next RTOR interval.

Users wishing to log heart rate based on the time elapsed between RRINT assertions using the μC to keep track of the time base (and ignoring the RTOR register data) have two choices for interrupt management. If CLR_RRINT equals 00 in the MNGR_INT register, the RRINT interrupt term will clear after each STATUS register read back, preparing the device for identification of the next RTOR interval. If CLR_RRINT equals 10 in the MNGR_INT register, the RRINT interrupt term will self-clear after each one full ECG data cycle has passed, preparing the device for identification of the next RTOR interval (this mode is recommended only if using the INT2B as a dedicated heart rate indicator).

If the RTOR detector reaches an overflow state after several minutes without detection of an R event, the counter will simply roll over, and the lack of the RRINT activity on the dedicated INT2B line will inform the μC that no RTOR activity was detected.

Typical Application Circuit

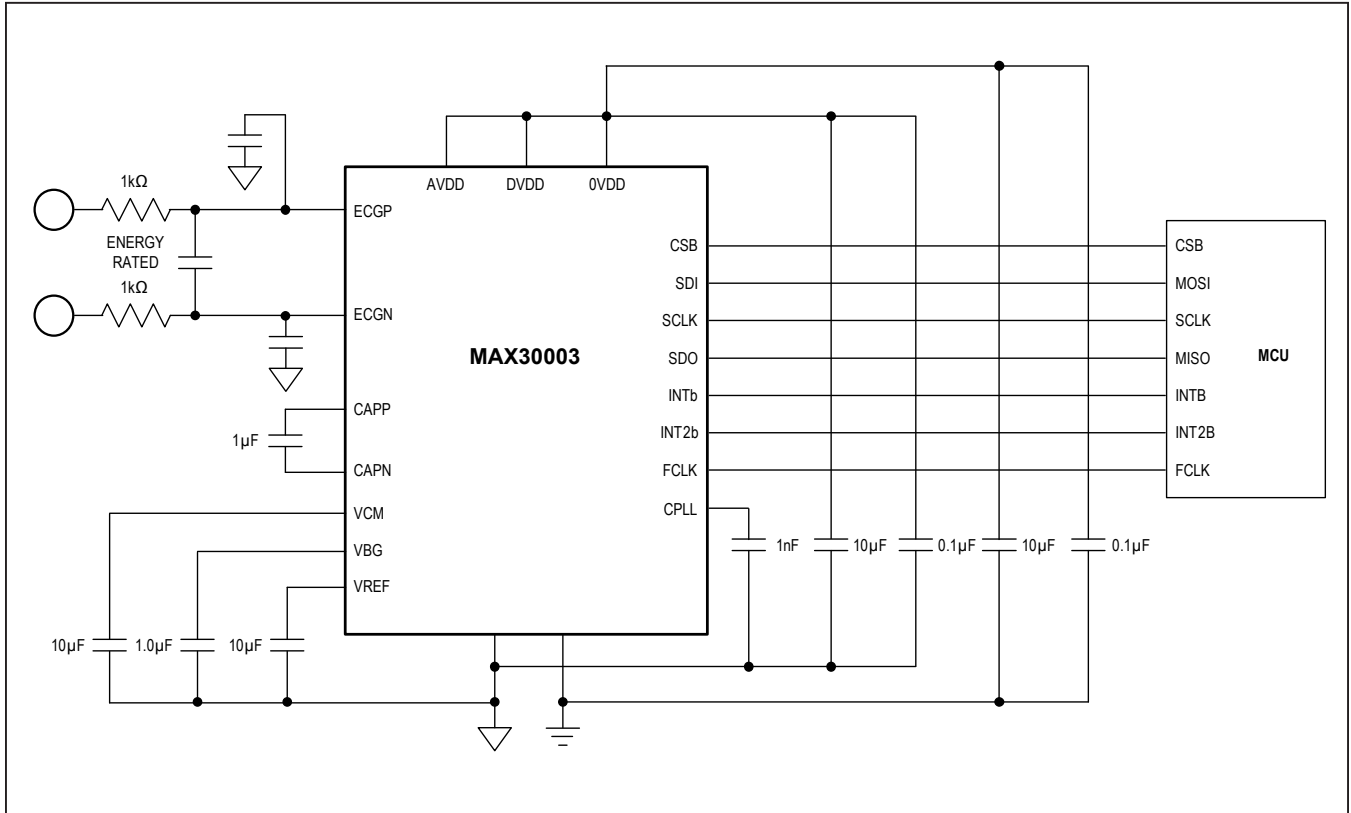

Figure 11. Two-terminal, with Differential and Common-Mode Filtering Typical Operating Circuit

Application Diagrams

Two Electrode Heart Rate Fitness

See [Figure 12](#) for an example of a fitness monitoring configuration.

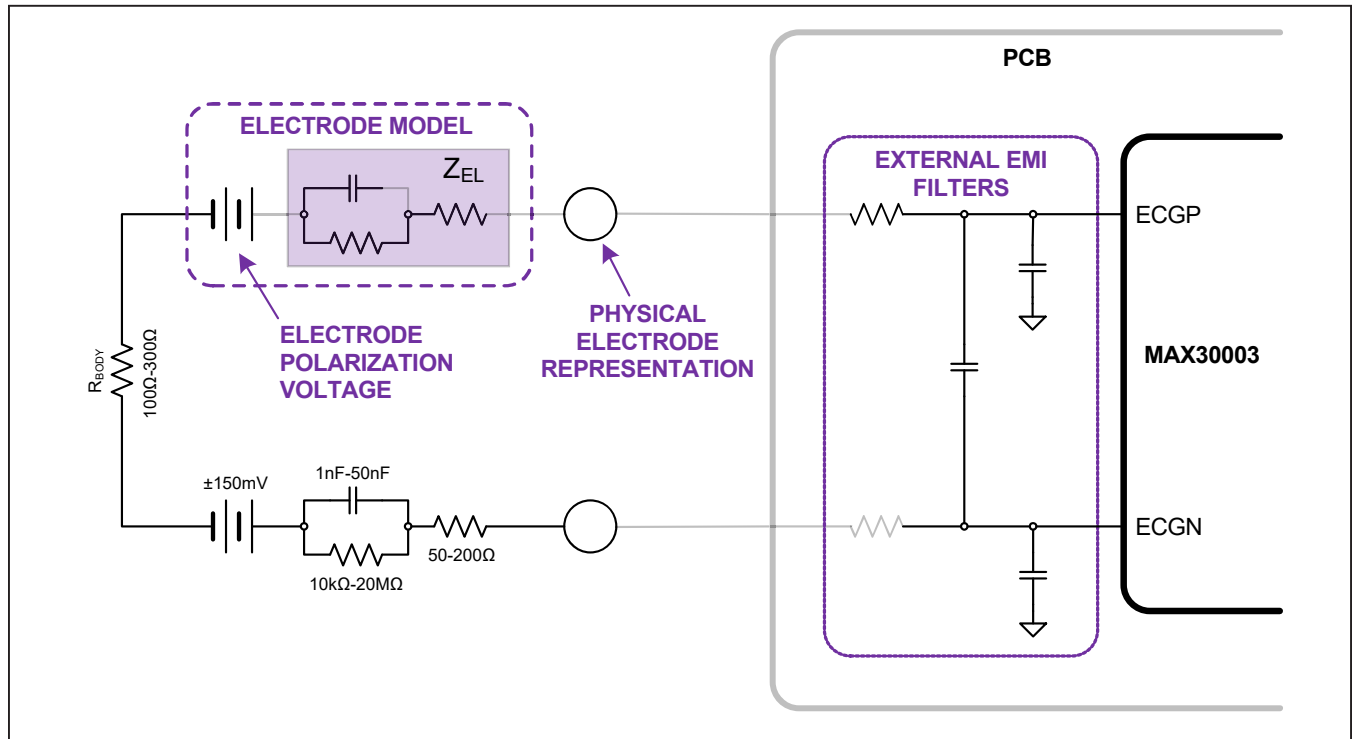

Figure 12. Two Electrode Heart Rate Monitoring for Fitness

Ordering Information

PART	TEMP RANGE	PIN-PACKAGE
MAX30003CTI+	0°C to +70°C	28 TQFN-EP**
MAX30003CTI+T	0°C to +70°C	28 TQFN-EP**
MAX30003CWV+T	0°C to +70°C	30 WLP

+Denotes a lead(Pb)-free/RoHS-compliant package.
 T = Tape and reel.
 **EP = Exposed pad.

Chip Information

PROCESS: CMOS

Package Information

For the latest package outline information and land patterns (footprints), go to www.maximintegrated.com/packages. Note that a "+", "#", or "-" in the package code indicates RoHS status only. Package drawings may show a different suffix character, but the drawing pertains to the package regardless of RoHS status.

PACKAGE TYPE	PACKAGE CODE	OUTLINE NO.	LAND PATTERN NO.
28-TQFN	T2855+8	21-0140	90-0028
30-WLP	W302L2+1	21-100074	Refer to Application Note 1891