

MAX30207 Evaluation Kit

Evaluates: MAX30207

General Description

The MAX30207 evaluation (EV) system provides a single platform to evaluate the MAX30207, a $\pm 0.1^{\circ}\text{C}$ accurate temperature sensor. The EV system consists of two boards connected through headers, a MAX32630FTHR microcontroller board, and the MAX30207_INTERFACE_EVKIT board. The EV system also includes a MAX30207_SENSOR_FLEX_EVKIT flex module that holds the MAX30207 IC. The MAX32630FTHR contains the firmware necessary to use the PC GUI program and provides power to the MAX30207 interface board. The MAX30207 interface board ships with jumpers preinstalled to allow quick evaluation of the MAX30207.

Benefits and Features

- Flexible PCB Design
 - Low Thermal Mass for Fast Response Time
 - Sense Temperature away from Extra Circuitry
- Easy to Reach Test Points
- Fully Assembled and Tested
- Windows® 10-Compatible Software

MAX30207 EV Kit Files

FILE	DESCRIPTION
MAX30207EVKitTool.exe	PC GUI Program

Ordering Information appears at end of data sheet.

MAX30207 EV Kit Photo

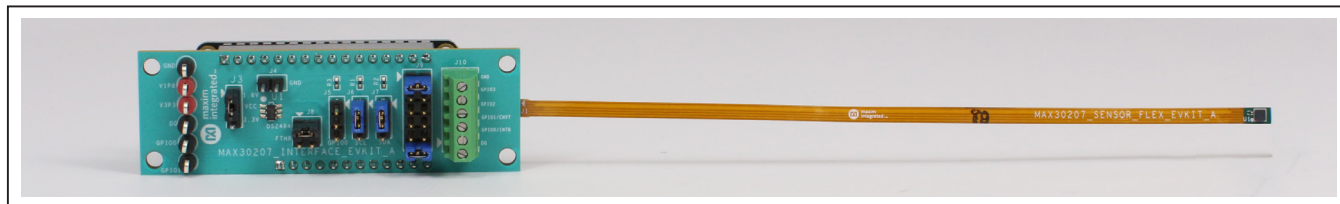

¹ Windows is a registered trademark and service mark of Microsoft Corporation.

Quick Start

Required Equipment

Note: In the following sections, software-related items are identified by bold text. Text in **bold** refers to items directly from the install of the EV kit software. **Bold and underlined** text refers to items from the Windows¹ operating system.

- MAX30207_INTERFACE_EVKIT REV-A
- MAX30207_SENSOR_FLEX_EVKIT REV-A
- MAX32630FTHR
- Micro-USB cable
- Windows PC with USB port
- MicroSD card (optional)
- Lithium-ion battery (optional)

Procedure

The EV kit is tested and shipped in three pieces. Follow these steps to assemble and verify board operation:

- 1) Plug the MAX32630FTHR into the MAX30207_INTERFACE_EVKIT_A.
- 2) Connect the MAX30207_SENSOR_FLEX_EVKIT_A to J11 on the interface board, ensuring the contact pads are on the bottom.
- 3) Set the EV kit hardware on a non-conductive surface to ensure nothing on the PCBs short together.
- 4) Connect the EV kit hardware to a PC with the provided USB cable. Attach the micro-USB end to the MAX32630FTHR. The other end to the PC. LED D1 on the MAX32630FTHR begins blinking blue.

- 5) Microsoft Windows automatically begins installing the necessary device driver. Once the driver installation is complete, a Windows message appears near the system icon menu, indicating the hardware is ready to use. Do not attempt to run the GUI prior to this message. To do so, close the application and restart it once the driver installation is complete. On some versions of Windows, administrator privileges are required to install the USB device.
- 6) Once the device drivers are installed, download the EV kit software from www.maximintegrated.com/evkit-software (MAX30207EVKitSoftwareInstall.ZIP) and extract it to a temporary folder.
- 7) Open the extracted ZIP folder and double-click the .EXE file to run the installer. If a message box stating 'The publisher could not be verified. Are you sure you want to run this software?' appears, select **Yes**.
- 8) When the installer GUI appears, click **Next**. Select the installation paths and if a shortcut should be created on the desktop. When prompted, press **Install**. Once complete, click **Close**.
- 9) If a shortcut is created, double-click on the created shortcut to start the GUI. Alternatively, go to Start | All Programs. Find the MAX30207EVKitTool folder and click on the MAX30207EVKitTool.EXE file inside the folder.
- 10) When the GUI appears, the text in the right field of the bottom status bar displays **Connected**. If the GUI displays **Not Connected**, ensure the flex PCB is properly connected and power-cycle the MAX30207 EV Kit.

Detailed Description of Software

Software Startup

If the EV system is connected when the software is opened, the software first initializes the hardware to communicate. The software then reads the device registers and updates all the associated control fields displayed on the GUI.

If the EV system is not connected on start-up, the GUI starts and displays no devices in the **Devices** section of the GUI and no temperature reading in the **Selected Device** section. The status bar at the bottom of the GUI states **Not Connected**.

Once an EV system is connected, the GUI automatically sets the device registers and begins taking temperature measurements.

ToolStrip Menu Bar

The ToolStrip menu bar ([Figure 1](#)) is located at the top of the GUI window. This bar comprises the **File**, **Device**, **Logging**, and **Help** menus, the functions of which are detailed in the following sections.

File Menu

The **File** menu contains the option to exit the GUI program.

Device Menu

The **Device** menu connects or disconnects an EV system to the GUI. If a board is disconnected while the GUI is open, the GUI displays **Hardware Not Connected** in the lower right corner. If the device is then plugged back in, navigate to the **Device** menu and select **Connect**. If successful, the bottom right corner of the GUI reads **Device Connected**.

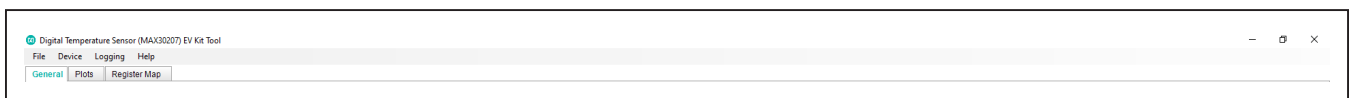

Figure 1. ToolStrip Menu Bar

Logging Menu

The only logging option is **MicroSD Logging**. MicroSD logging operates the EV kit without a connection to a host PC or power supply. First, insert a microSD card into the connector at the bottom of the MAX32630FTHR. For logging under battery powered, after selecting the logging interval and writing the selection to the microSD card (Figure 3), connect a 3.7V lithium-ion battery with a JST PH connector to the MAX32630FTHR and then disconnect the board from the host PC. Refer to the MAX32630FTHR documentation for details on connecting a Li+ battery. Press SW2 on the MAX32630FTHR board to start (LED D1 blinking red) saving measurements to the SD card. Pressing SW2 again (LED D1 blinking blue)

stops measurements. To transfer the logged data from the MicroSD card to a file on a PC, reconnect the MAX30207 EV kit to the PC and select microSD card logging from the **Logging** menu. Select the 'Save to File' option and a prompt appears to name the log file (Figure 2). For subsequent logging sessions, press 'Clear Log' on the 'Setup MicroSD Logging' screen to prevent multiple data sets being recorded to the same log file. Data logging can also be accomplished by using 'Save' in the 'Plot' tab.

Help Menu

The **Help** menu contains information to aid with any problems in the use of the GUI. **About** displays the GUI splash screen indicating the GUI version being used.

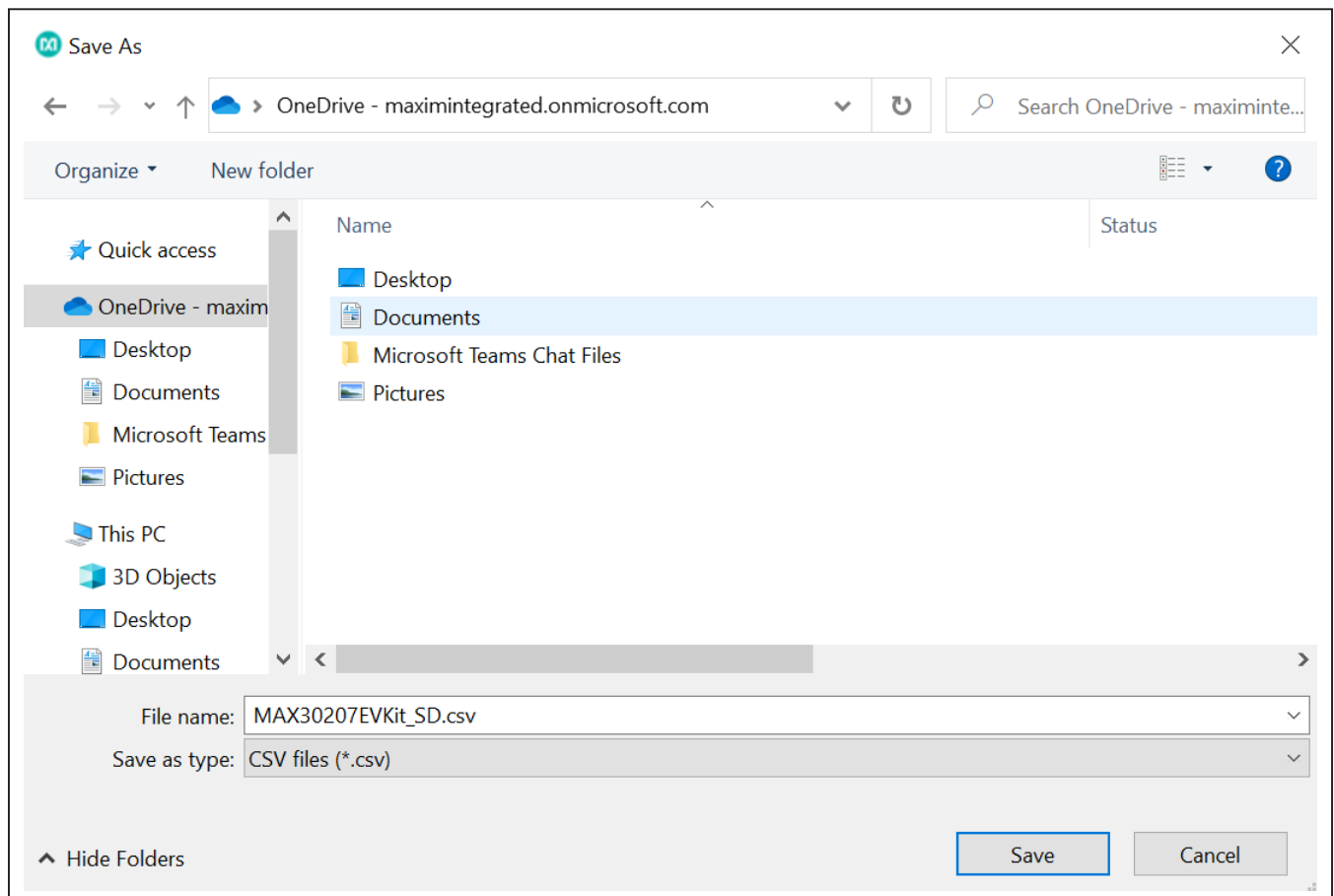

Figure 2. File Naming Screen for Logging

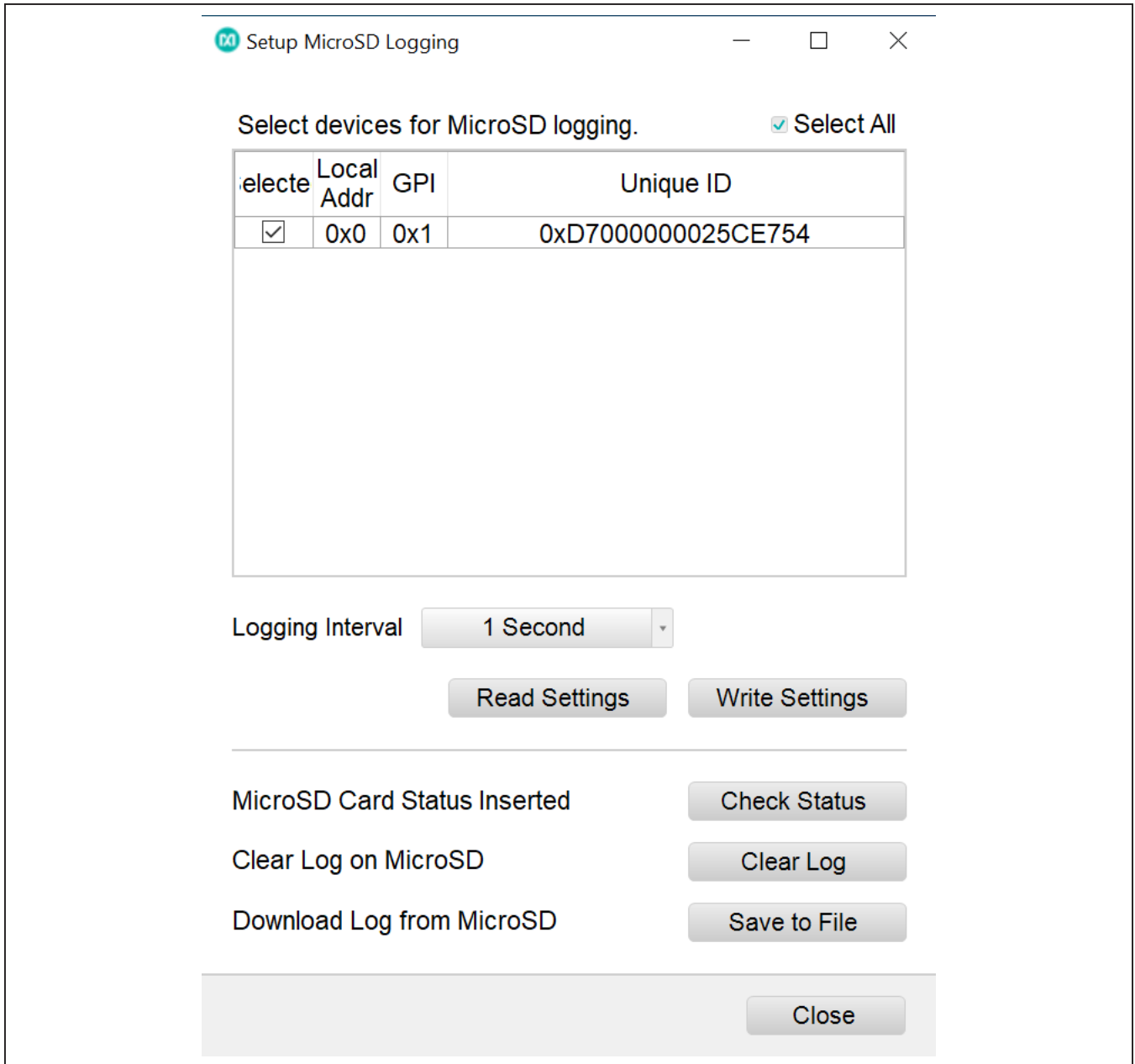

Figure 3. MicroSD Logging Prompt

Tab Control

The main interface structure of the GUI consists of the **General**, **Plot**, and **Register Map** tabs, where each tab contains controls relevant to various blocks of the device.

General Tab

The **General Tab** (Figure 4) displays a general overview of the MAX30207. The tab provides a list of devices connected, temperature data for a selected device, as well as controls for select registers.

Plot Tab

The Plot tab plots the measured data for a single MAX30207 temperature sensor (device), or a list of devices

connected by selecting the device using the check box in the plot column. Use 'Plot Duration' and 'Sample Temperature Every' to set the plot duration and sample rate, then click 'Start' (Figure 5). The other function of the plot tab is to log the temperature data that provides a way to export each data sample being measured by the device. After the plot is started, click 'Save' to save the plotted data to a file. A prompt then appears to choose a name for the comma-separated value (CSV) log file, as well as the location to save the generated file. Figure 6 shows the log file format. Click 'Reset' to clean the buffer and prevent multiple data sets being recorded to the same log file.

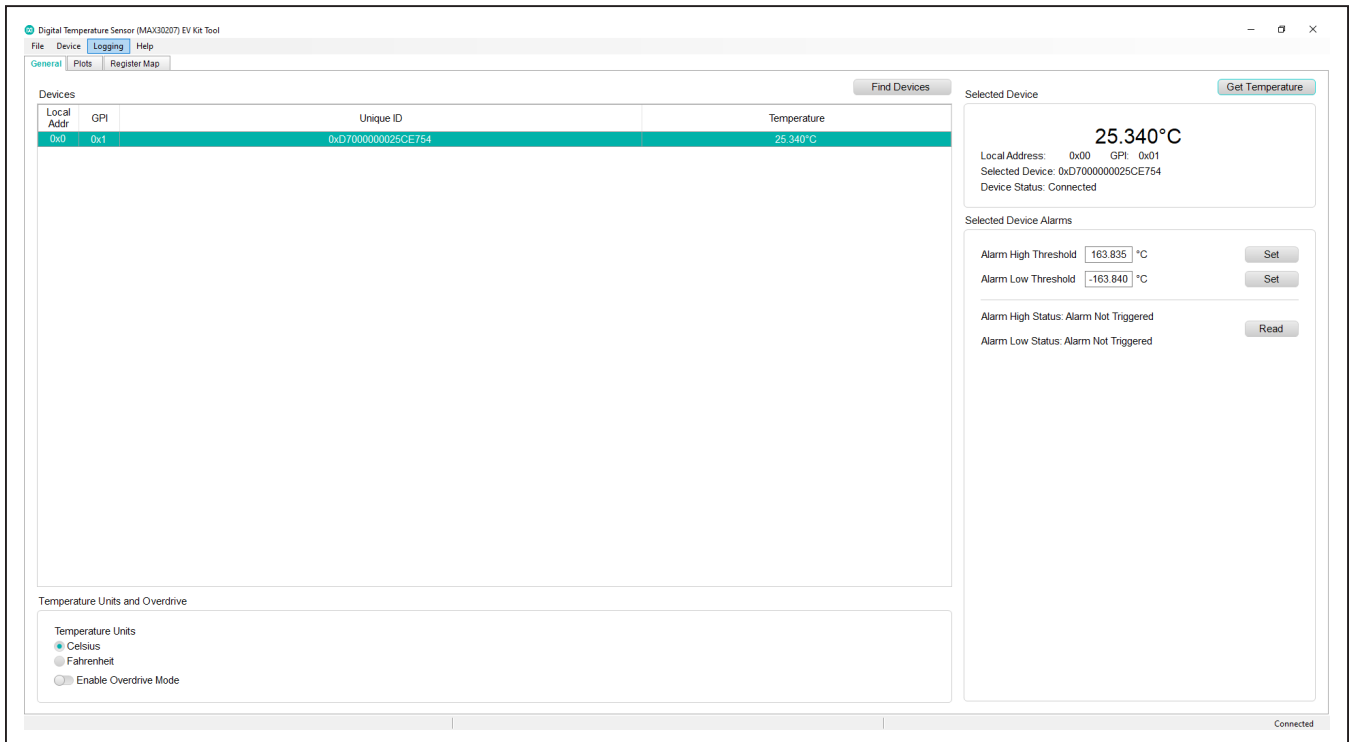

Figure 4. General Tab

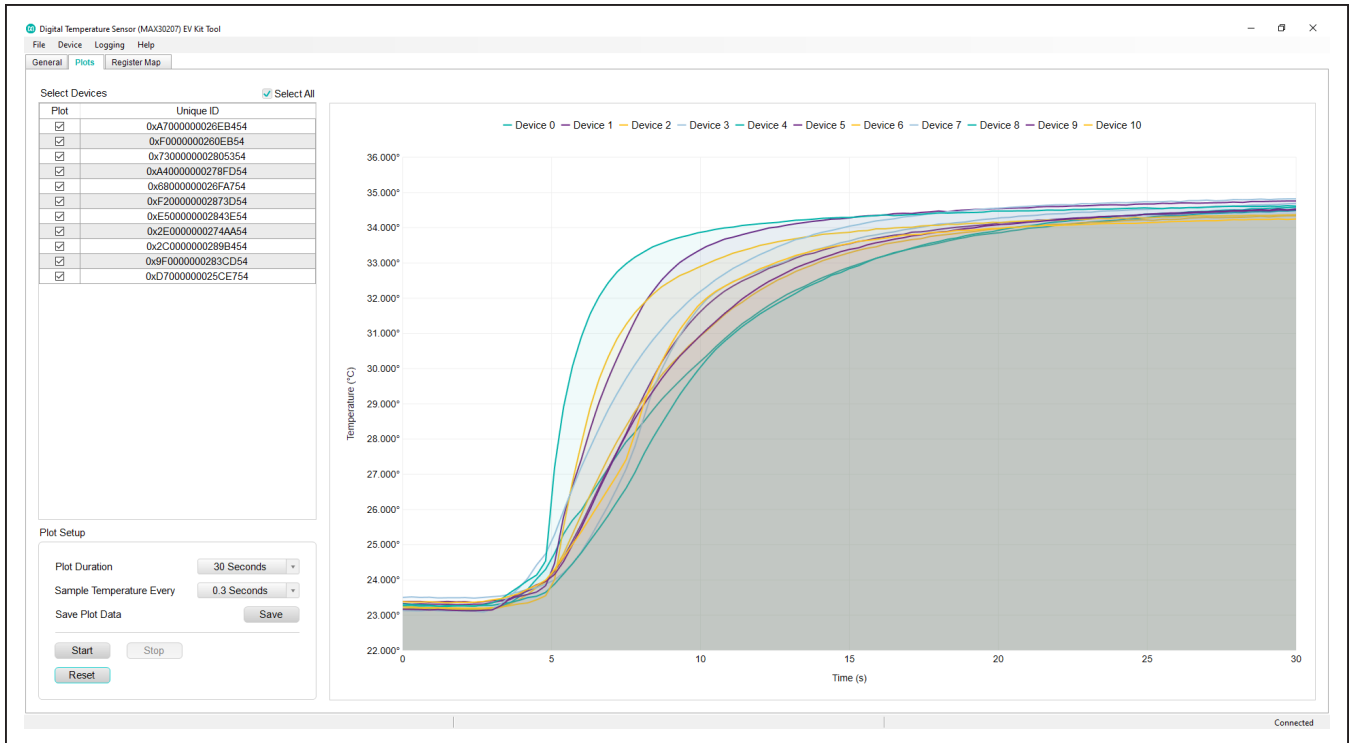

Figure 5. Plot Tab

Clipboard															
Font				Alignment				Number				Styles			
Device List															
A	B	C	D	E	F	G	H	I	J	K	L	M	N	O	P
Device List															
2	Device Nu	Local Addi	GPI	Unique ID											
3	0	0x0	0x0	0xA700000026EB454											
4	1	0x0	0x0	0x0F000000260EB54											
5	2	0x0	0x0	0x730000002805354											
6	3	0x0	0x0	0xA4000000278FD54											
7	4	0x0	0x0	0x6800000026FA754											
8	5	0x0	0x0	0xF20000002873D54											
9	6	0x0	0x0	0xE50000002843E54											
10	7	0x0	0x0	0x2E000000274AA54											
11	8	0x0	0x0	0x2C000000289B454											
12	9	0x0	0x0	0x9F000000283CD54											
13	10	0x0	0x0	0xD700000025CE754											
Temperature Log															
15	Time (s)	Device 0 T	Device 1 T	Device 2 T	Device 3 T	Device 4 T	Device 5 T	Device 6 T	Device 7 T	Device 8 T	Device 9 T	Device 10 T	Temperature (°C)		
16	0	23.405	23.55	23.4	23.49	23.54	23.64	23.415	23.38	23.48	23.43	23.565			
17	1	23.41	23.565	23.4	23.515	23.53	23.62	23.415	23.375	23.495	23.44	23.58			
18	2	23.425	23.555	23.425	23.495	23.535	23.63	23.435	23.39	23.505	23.445	23.58			
19	3	23.415	23.545	23.435	23.495	23.525	23.63	23.435	23.4	23.505	23.45	23.565			
20	4	23.4	23.525	23.425	23.465	23.52	23.615	23.435	23.39	23.475	23.42	23.54			
21	5	23.385	23.49	23.4	23.44	23.475	23.61	23.41	23.37	23.445	23.42	23.5			
MAX30207EVKit_Plot_2021-07-19_1															

Figure 6. Log File Format

Register Map Tab

The Registers Map tab (Figure 7) provides more direct access to the internal registers of the MAX30207. From this tab, read the contents of individual registers and manually enter the desired bit settings using a write operation. For the register address selected in the table, the bit values are displayed at the bottom of the tab and visualized as bold or non-bold bit names. When a bit is

bold, its value is 1. Otherwise, the bit is 0. Full descriptions of each bit are available in the table on the right for quick reference. Pressing **Read** reads the selected register. Pressing **Read All** reads all registers and updates their values in the **Registers** tab. To write to a register, set the desired bit values by clicking on the bit names to make bold or non-bold, and then select **Write**.

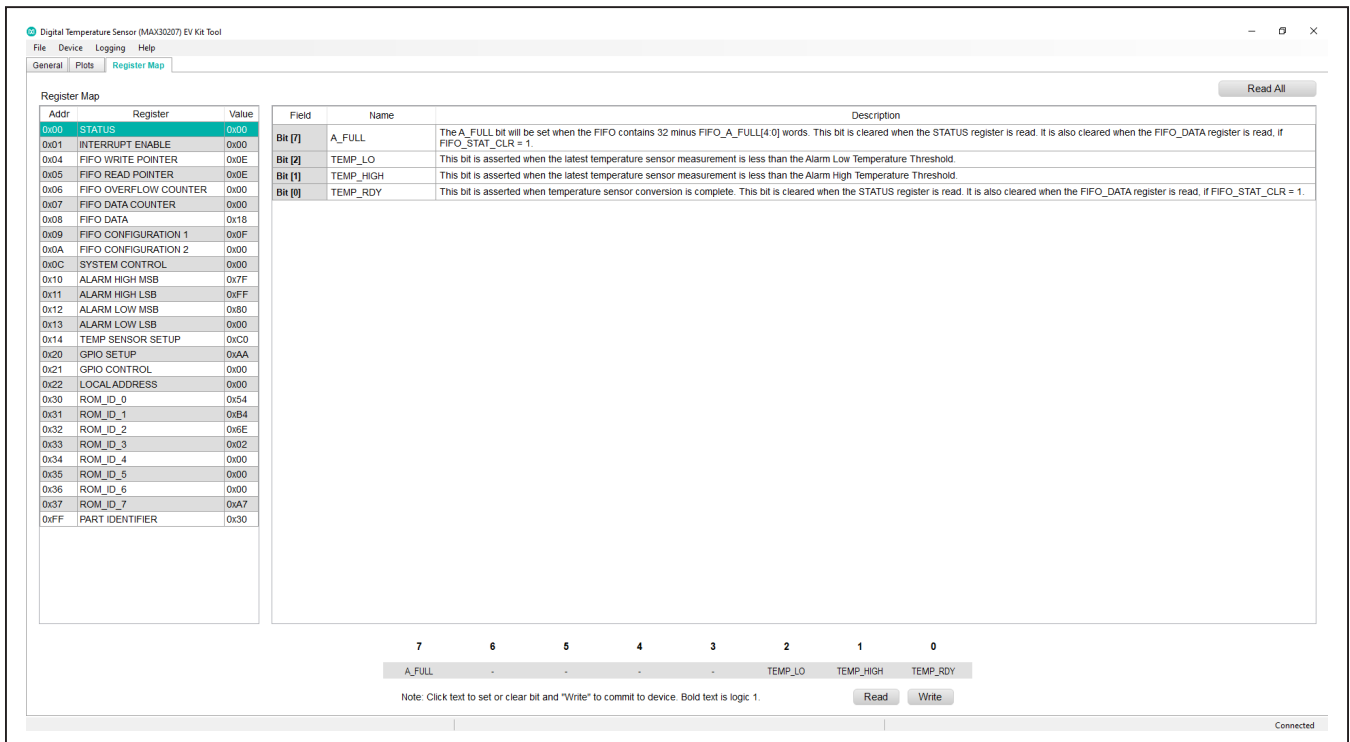

Figure 7. Register Map Tab

Detailed Description of Hardware

The MAX30207 EV kit provides a single platform to evaluate the functionality and features of the MAX30207. The board contains jumpers to test the MAX30207 under several conditions. A list of all jumpers and their respective functions is available in [Table 1](#).

The EV system utilizes the MAX32630FTHR Cortex-M4F Microcontroller for wearables to interface with the GUI and optionally provide power to the MAX30207. The MAX32630FTHR operates either from a host PC or directly from a Li+ battery. If an SD card is present in the

MAX32630FTHR, pressing SW2 on the MAX32630FTHR initiates measurements and saves log files to the SD card. Logging is stopped by pressing SW2 a second time.

Powering the EV Kit

The MAX30207 EV kit is powered directly from the MAX32630FTHR through either a lithium-ion battery or a USB to Micro-USB cable. J3 must be connected to the 1.8V option to supply power from the MAX32630FTHR. J9 and J10 can be used to connect the interface board, through wires, to another board that contains the MAX30207 IC.

Table 1. Description of Jumpers

JUMPER	DESCRIPTION
J3-1 to J3-2	Connect V _{CC} to 1.8V of the MAX32630FTHR.
J5-1 to J5-2	Connects GPIO0_INTB to 4.7kΩ pullup (optional).
J6-1 to J6-2	Connect SCL to 4.7kΩ pullup.
J7-1 to J7-2	Connect SDA to 4.7kΩ pullup.
J8-1 to J8-2	Select the 1-Wire communication protocol by connecting 'DS2484'.
J9	Connects each signal from the interface board to the flex module connector and the J10 terminal block. Ground (pin 1 and 2) and DQ (pin 11 and 12) must be connected.

Component Suppliers

SUPPLIER	WEBSITE
Keystone	www.keyelco.com
Maxim Integrated	www.maximintegrated.com
Molex	www.molex.com
Murata	www.murata.com
Panasonic	www.industrial.panasonic.com
Samtec	www.samtec.com
Sullins	www.sullinscorp.com
TE Connectivity	www.te.com

Note: Indicates using the MAX30207 when contacting these component suppliers.

Ordering Information

PART	TYPE
MAX30207EVSYS#	EV Kit

MAX30207 Flex PCB Bill of Materials (BOM)

ITEM	REF_DES	DNI/DNP	QTY	MFG PART #	MANUFACTURER	VALUE	DESCRIPTION
1	C1	-	1	GRM033C81E104KE14	MURATA	0.1UF	CAPACITOR; SMT (0201); CERAMIC CHIP; 0.1UF; 25V; TOL=10%; TG=-55 DEGC TO +105 DEGC; TC=X6S
2	U1	-	1	MAX30207CLB+	MAXIM	MAX30207	EVKIT PART - IC; MAX30207; 1-WIRE DIGITAL TEMPERATURE SENSOR; PACKAGE OUTLINE DRAWING: 21-100265; LGA10
3	PCB	-	1	MAX30207SENSORFLEX	MAXIM	PCB	PCB:MAX30207SENS ORFLEX
4	J1	DNP	0	5051100692_EDGE	MOLEX	5051100692_EDGE	CONNECTOR; FEMALE; SMT; FD19 SERIES; RIGHT ANGLE; 6PINS

MAX30207 Interface Board Bill of Materials (BOM)

ITEM	REF_DES	DNI/DNP	QTY	MFG PART #	MANUFACTURER	VALUE	DESCRIPTION
1	DQ_GND, GPIO0, GPIO1	-	4	5006	KEystone	N/A	TEST POINT; PIN DIA=0.125IN; TOTAL LENGTH=0.35IN; BOARD HOLE=0.063IN; BLACK; PHOSPHOR BRONZE WIRE SILVER PLATE FINISH
2	J1	-	1	PPPC161LFBN-RC	SULLINS ELECTRONICS CORP.	PPPC161LFBN-RC	CONNECTOR; FEMALE; THROUGH HOLE; LFB SERIES; 2.54MM CONTACT CENTER; STRAIGHT; 16PINS
3	J2	-	1	PPPC121LFBN-RC	SULLINS ELECTRONICS CORP.	PPPC121LFBN-RC	CONNECTOR; FEMALE; THROUGH HOLE; HEADER FEMALE; STRAIGHT; 12PINS
4	J3, J5-J7	-	4	TSW-103-07-L-S	SAMTEC	TSW-103-07-L-S	CONNECTOR; THROUGH HOLE; SINGLE ROW; STRAIGHT; 3PINS
5	J4	-	1	TSW-102-07-T-S	SAMTEC	TSW-102-07-T-S	CONNECTOR; THROUGH HOLE; TSW SERIES; SINGLE ROW; STRAIGHT; 2PINS; -55 DEGC TO +105 DEGC
6	J8	-	1	TSW-102-07-L-D	SAMTEC	TSW-102-07-L-D	CONNECTOR; MALE; THROUGH HOLE; TSW SERIES; STRAIGHT; 4PINS
7	J9	-	1	TSW-106-07-L-D	SAMTEC	TSW-106-07-L-D	CONNECTOR; MALE; THROUGH-HOLE .025 IN SQ POST HEADER; STRAIGHT; 12PINS
8	J10	-	1	282834-6	TE CONNECTIVITY	282834-6	CONNECTOR; FEMALE; THROUGH HOLE; TERMINAL BLOCK PCB MOUNT SIDE WIRE ENTRY STACKING; STRAIGHT; 6PINS
9	J11	-	1	5051100692	MOLEX	5051100692	CONNECTOR; FEMALE; SMT; FD19 SERIES; RIGHT ANGLE; 6PINS
10	R1-R3	-	3	ERJ-2RKF4701	PANASONIC	4.7K	RESISTOR; 0402; 4.7K OHM; 1%; 100PPM; 0.10W; THICK FILM

MAX30207 Interface Board Bill of Materials (BOM) (continued)

ITEM	REF_DES	DNI/DNP	QTY	MFG PART #	MANUFACTURER	VALUE	DESCRIPTION
11	U1	-	1	DS2484R+	MAXIM	DS2484R+	IC; INFC; SINGLE-CHANNEL 1-WIRE MASTER WITH ADJUSTABLE TIMING AND SLEEP MODE; SOT23-6
12	V1P8, V3P3	-	2	5005	KEYSTONE	N/A	TEST POINT; PIN DIA=0.125IN; TOTAL LENGTH=0.35IN; BOARD HOLE=0.063IN; RED; PHOSPHOR BRONZE WIRE SILVER PLATE FINISH
13	PCB		1	MAX30207INTERFACE	MAXIM	PCB	PCB:MAX30207INTERFACE

MAX30207 Flex Schematic

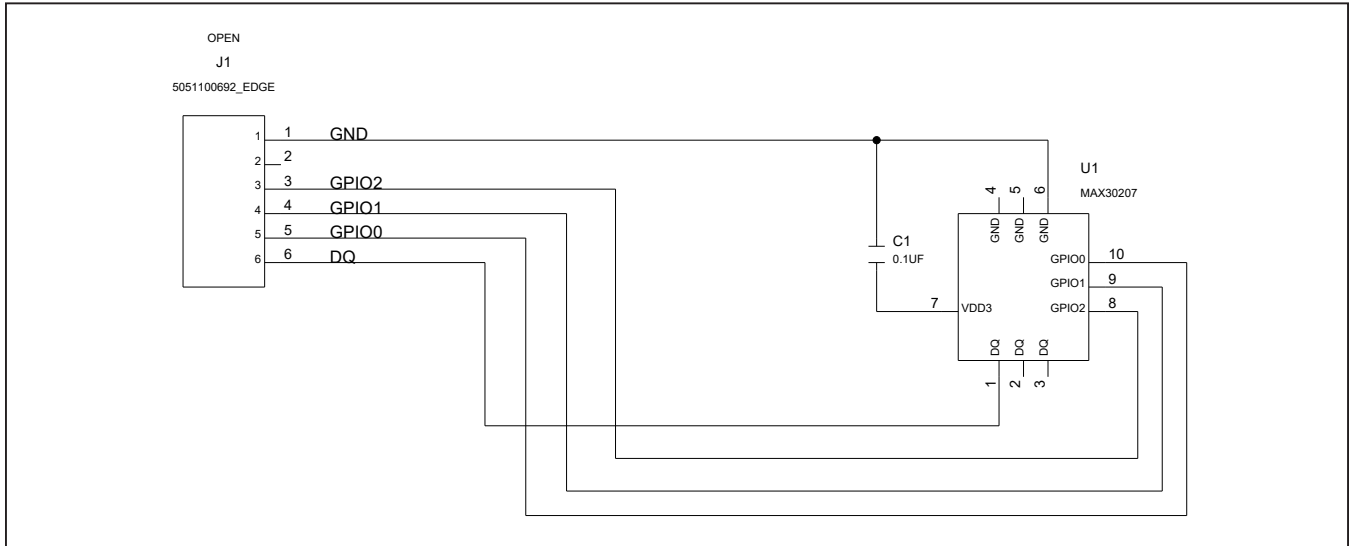

MAX30207 Interface Schematic

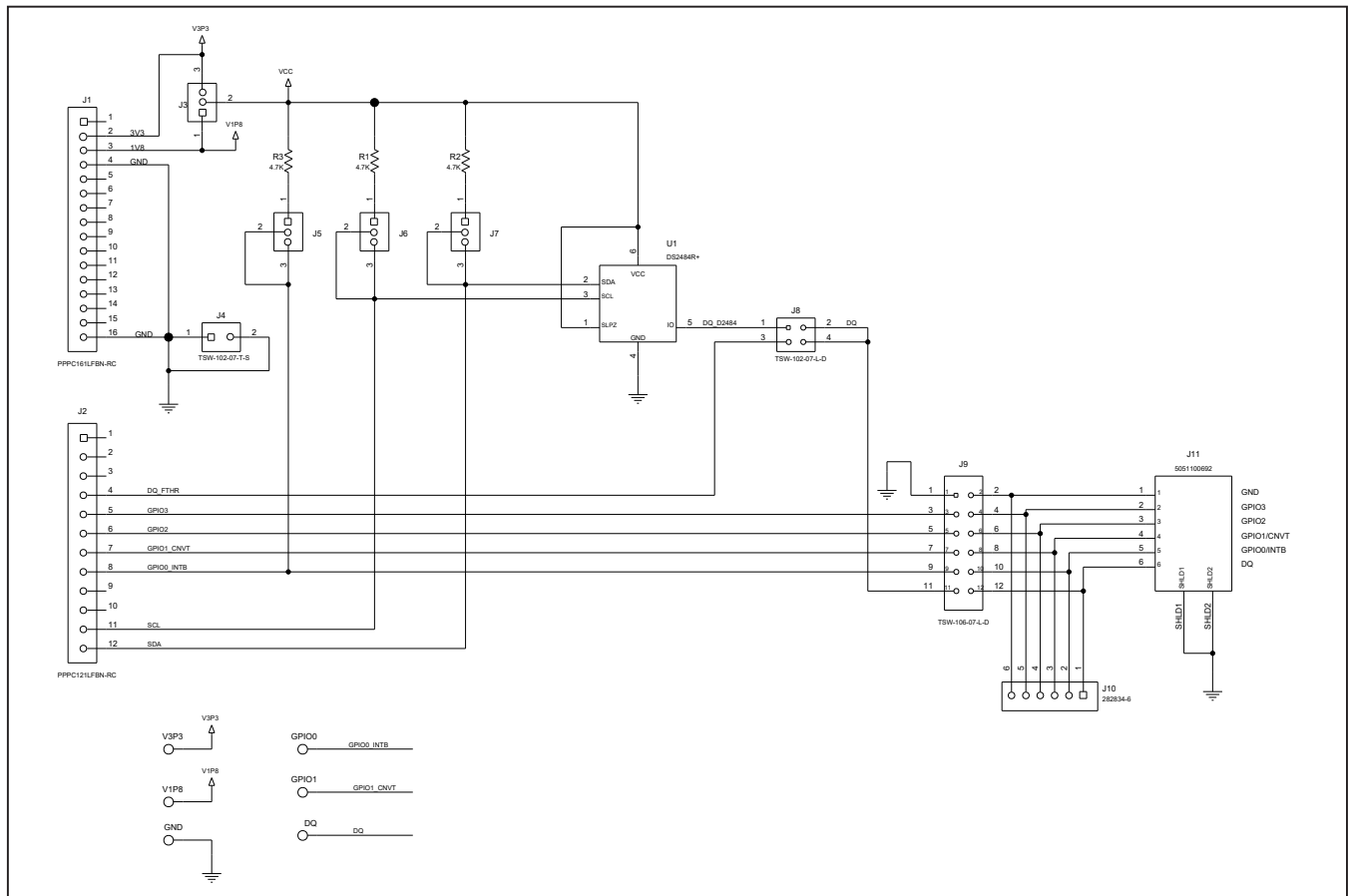

MAX30207 Flex PCB Layout

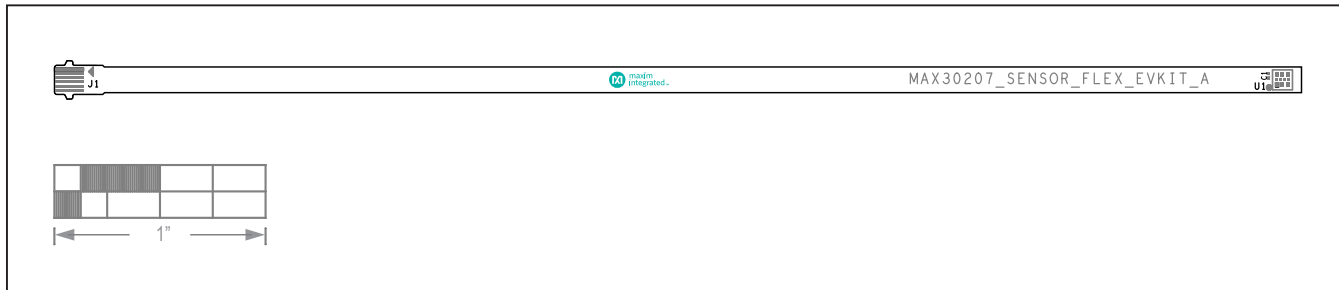

MAX30207EV Flex — Silk Top

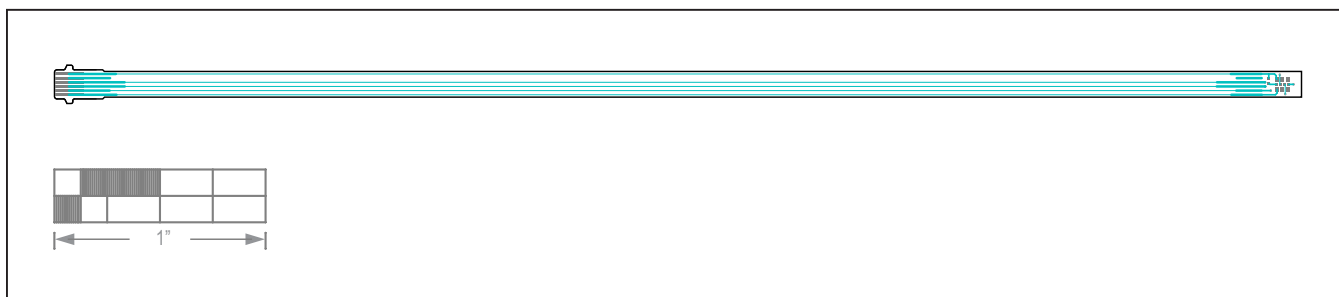

MAX30207EV Flex — Top

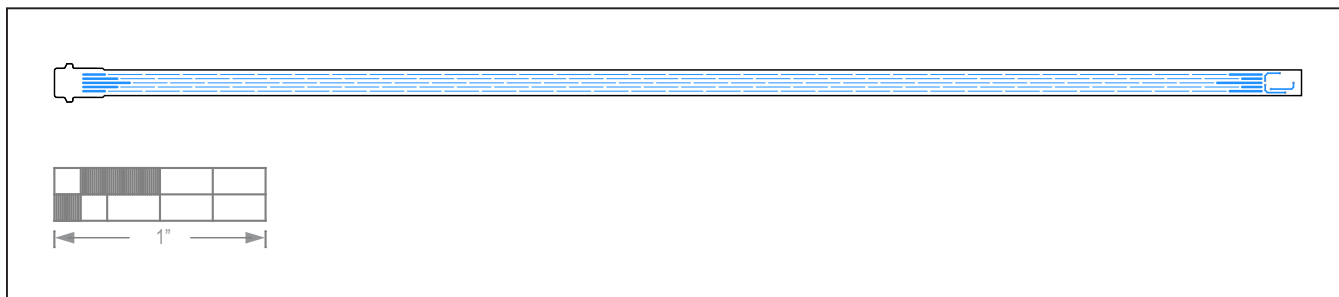

MAX30207EV Flex — Bottom

MAX30207 Interface PCB Layout

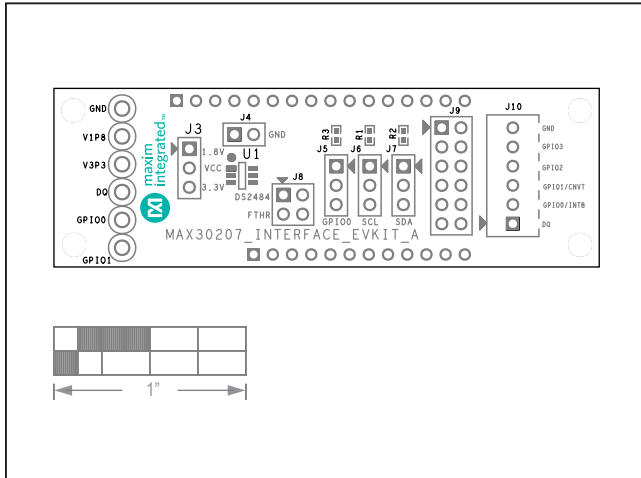

MAX30207EV Interface — Silk Top

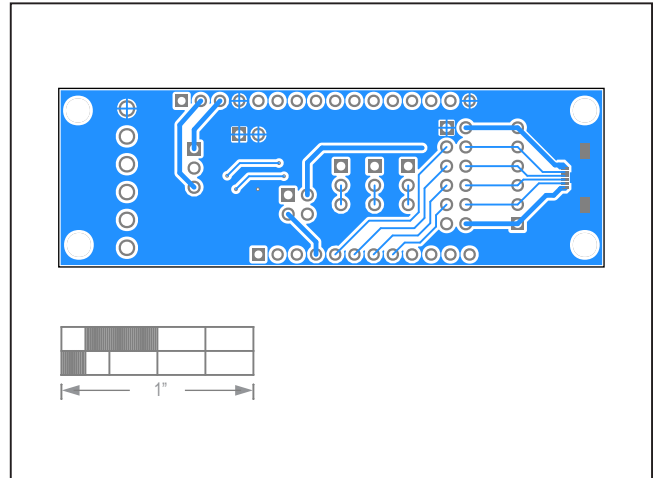

MAX30207EV Interface — Bottom

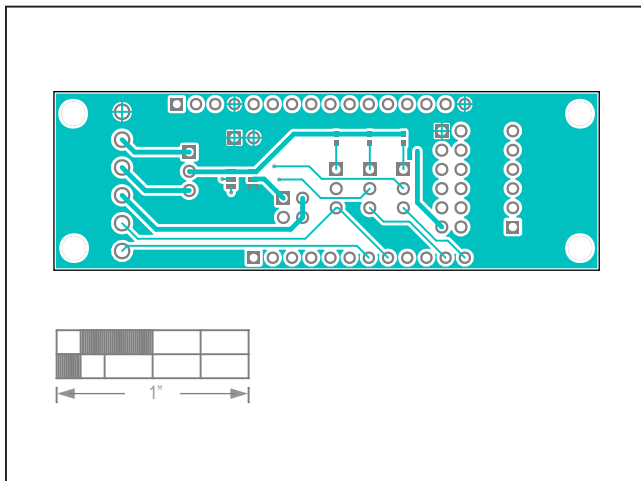

MAX30207EV Interface — Top

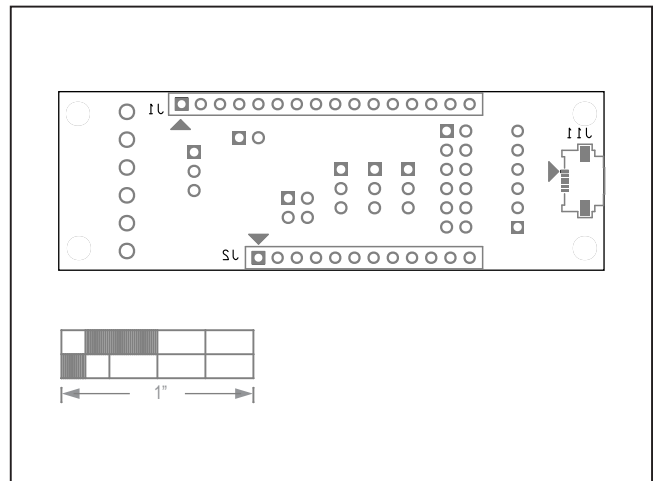

MAX30207EV Interface — Silk Bottom