



# Low-Profile, 3V, 120µA, IrDA Infrared Transceiver

MAX3120

## General Description

The MAX3120 IrDA 1.2-compatible infrared transceiver is optimized for battery-powered, space-constrained applications. It consumes only 120µA while supporting data rates up to 115kbps over a wide 3V to 5.5V operating range, and features a 10nA shutdown mode to further extend battery life.

The MAX3120 reduces the space required for IrDA applications by requiring a minimum of external components: photodiode, infrared LED, and current-setting resistor. Optical components are external to allow maximum flexibility in PC board design. The MAX3120 is available in 8-pin µMAX and SO packages. The µMAX package consumes half the board space of an 8-pin SO.

## Applications

- IrDA Applications
- Personal Digital Assistants (PDAs)
- Palmtop Computers
- Cell Phones
- Hand-Held Equipment
- Peripherals

## Pin Configuration

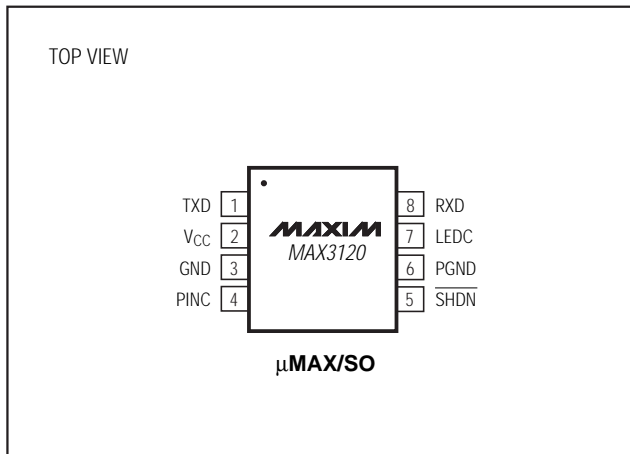

## Features

- ◆ IrDA 1.2 Compatible: 2.4kbps to 115.2kbps
- ◆ +3V to +5.5V Single-Supply Operation
- ◆ Flexible Optics Selection and Layout
- ◆ 120µA Supply Current
- ◆ 10nA Shutdown Supply Current
- ◆ 200mA, High-Current Infrared LED Drive

## Ordering Information

PART	TEMP. RANGE	PIN-PACKAGE
MAX3120CUA	0°C to +70°C	8 µMAX
MAX3120CSA	0°C to +70°C	8 SO
MAX3120EUA	-40°C to +85°C	8 µMAX
MAX3120ESA	-40°C to +85°C	8 SO

## Typical Operating Circuit

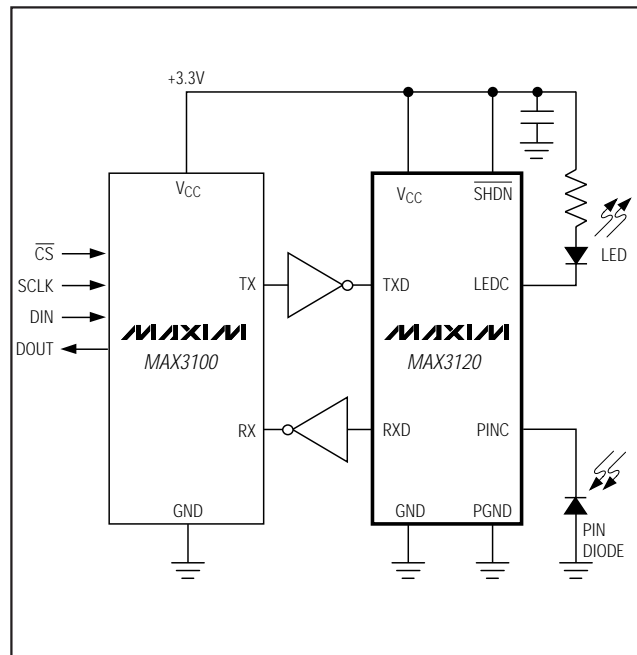

# Low-Profile, 3V, 120 $\mu$ A, IrDA Infrared Transceiver

## ABSOLUTE MAXIMUM RATINGS

(Referred to GND)

V <sub>CC</sub> .....	-0.3V to +6V
TXD, SHDN, LEDC.....	-0.3V to +6V
RXD.....	-0.3V to (V <sub>CC</sub> + 0.3V)
PGND.....	-0.1V to +0.1V
PINC.....	10mA
Continuous LEDC Current.....	200mA
Repetitive Pulsed LEDC Current (<90 $\mu$ s, duty cycle <20%).....	500mA

Continuous Power Dissipation (T<sub>A</sub> = +70°C)

$\mu$ MAX (derate 4.1mW/°C above +70°C).....	330mW
SO (derate 5.88mW/°C above +70°C).....	471mW
Operating Temperature Ranges	
MAX3120C_A.....	0°C to +70°C
MAX3120E_A.....	-40°C to +85°C
Junction Temperature.....	+150°C
Storage Temperature Range.....	-65°C to +160°C
Lead Temperature (soldering, 10sec).....	+300°C

Stresses beyond those listed under "Absolute Maximum Ratings" may cause permanent damage to the device. These are stress ratings only, and functional operation of the device at these or any other conditions beyond those indicated in the operational sections of the specifications is not implied. Exposure to absolute maximum rating conditions for extended periods may affect device reliability.

## ELECTRICAL CHARACTERISTICS

(V<sub>CC</sub> = +3.0V to +5.5V, T<sub>A</sub> = T<sub>MIN</sub> to T<sub>MAX</sub>, unless otherwise noted. Typical values are at T<sub>A</sub> = +25°C and V<sub>CC</sub> = +3.3V.)

PARAMETER	SYMBOL	CONDITIONS	MIN	TYP	MAX	UNITS
<b>DC CHARACTERISTICS</b>						
Supply Current	I <sub>CC</sub>	T <sub>A</sub> = +25°C, $\overline{\text{SHDN}} = \text{V}_{\text{CC}}$ (Note 1)		120	200	$\mu$ A
Shutdown Supply Current	I <sub>CC(SHDN)</sub>	T <sub>A</sub> = +25°C, $\overline{\text{SHDN}} = \text{GND}$ (Note 1)		0.01	1.0	$\mu$ A
<b>LOGIC INPUTS (TXD, SHDN)</b>						
Input Logic Threshold Low	V <sub>IL</sub>				0.8	V
Input Logic Threshold High	V <sub>IH</sub>	V <sub>CC</sub> = 3.3V	2.0			V
		V <sub>CC</sub> = 5.0V	2.4			
Input Leakage Current	I <sub>LEAK</sub>		-1		1	$\mu$ A
Input Capacitance	C <sub>IN</sub>			2		pF
<b>LOGIC OUTPUT (RXD)</b>						
Output Voltage	V <sub>OL</sub>	I <sub>SINK</sub> = 200 $\mu$ A		0.1	0.4	V
	V <sub>OH</sub>	I <sub>SOURCE</sub> = 100 $\mu$ A	V <sub>CC</sub> - 0.5	V <sub>CC</sub> - 0.05		
Output Rise and Fall Time	t <sub>r</sub> , t <sub>f</sub>	C <sub>LOAD</sub> = 50pF		50		ns
<b>IR RECEIVER</b>						
Supported Data Rates			2.4		115.2	kbps
Equivalent Input Noise Current	I <sub>NOISE</sub>	(Note 2)		10		nA <sub>RMS</sub>
Input Current Sensitivity		(Note 3)	0.0002		6	mA
Ambient DC Current Rejection		V <sub>CC</sub> = 3.3V		100		$\mu$ A
		V <sub>CC</sub> = 5.0V		375		
Shutdown Time		Delay until I <sub>CC</sub> < 1 $\mu$ A		10		$\mu$ s
Shutdown Disable Time		Delay until maximum IR receiver data rate is valid		300		$\mu$ s
IR Receiver Output Pulse Width		Data rate = 2.4kbps	1		90	$\mu$ s
		Data rate = 115.2kbps	1		8	

# Low-Profile, 3V, 120 $\mu$ A, IrDA Infrared Transceiver

MAX3120

## ELECTRICAL CHARACTERISTICS (continued)

( $V_{CC} = +3.0V$  to  $+5.5V$ ,  $T_A = T_{MIN}$  to  $T_{MAX}$ , unless otherwise noted. Typical values are at  $T_A = +25^\circ C$  and  $V_{CC} = +3.3V$ .)

PARAMETER	SYMBOL	CONDITIONS	MIN	TYP	MAX	UNITS
<b>IR TRANSMITTER</b>						
Transmitter Rise Time	$t_r$	10% to 90% of 200mA drive current		20	600	ns
Transmitter Fall Time	$t_f$	90% to 10% of 200mA drive current		20	600	ns
Transmitter Output Resistance		$I_{OUT} = 200mA$	$V_{CC} = 3.3V$	1.15	2.0	$\Omega$
			$V_{CC} = 5.0V$	0.9	1.6	
Off-Leakage Current				0.01	10	$\mu A$

**Note 1:** All supply current measurements are made under the following conditions: no load at all outputs, input voltages at GND or  $V_{CC}$ , no PIN diode input current.

**Note 2:** Equivalent input current noise is calculated by dividing the output noise of the transimpedance amplifier by the midband transimpedance gain.

**Note 3:** Sensitivity is measured with an IrDA-compliant input signal, where the data rate is within the Supported Data Rate, rise/fall times are less than 600ns, and pulse widths are between 1.41 $\mu$ s and 3/16 of the baud rate.

## Typical Operating Characteristics

( $T_A = +25^\circ C$ , unless otherwise noted.)

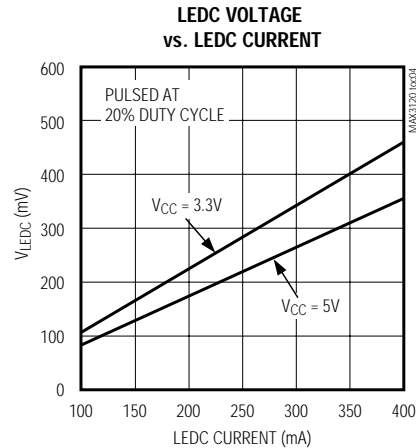
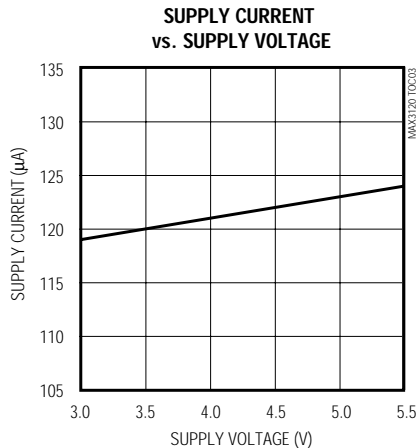
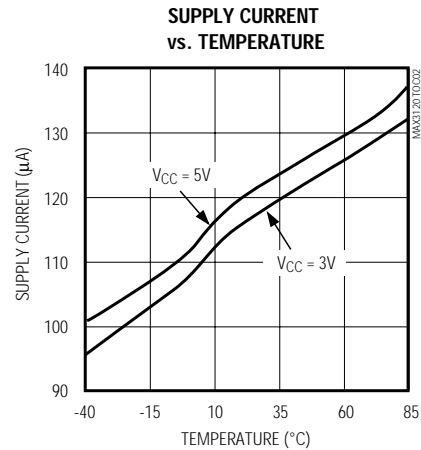
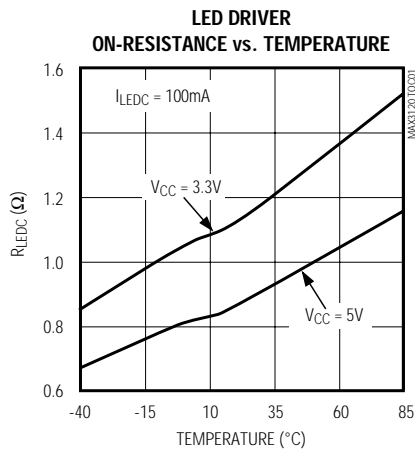

# Low-Profile, 3V, 120 $\mu$ A, IrDA Infrared Transceiver

## Typical Operating Characteristics (continued)

(T<sub>A</sub> = +25°C, unless otherwise noted.)

**AMBIENT PHOTODIODE CURRENT REJECTION vs. SUPPLY VOLTAGE**

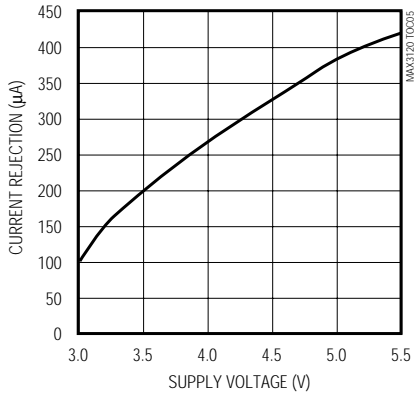

**RXD OUTPUT PULSE WIDTH vs. DISTANCE**

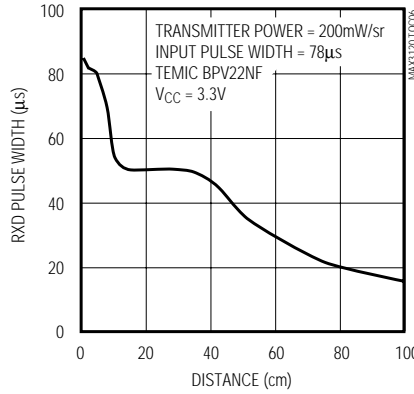

**RXD OUTPUT PULSE WIDTH vs. DISTANCE**

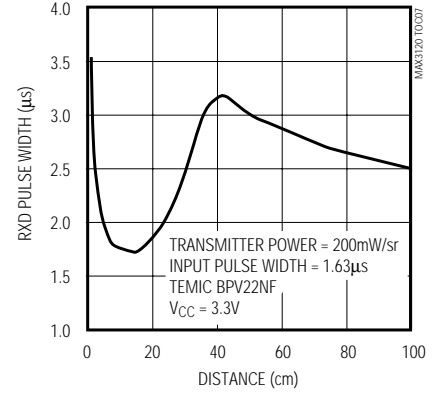

**RXD OUTPUT vs. INFRARED INPUT**

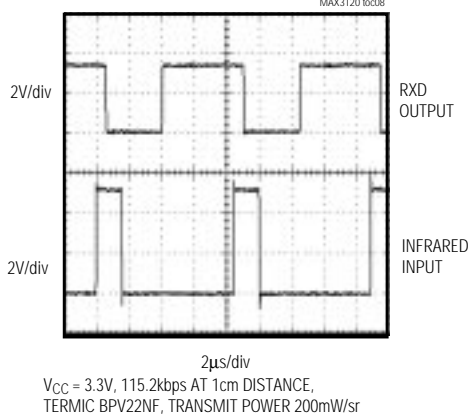

**RXD OUTPUT vs. INFRARED INPUT**

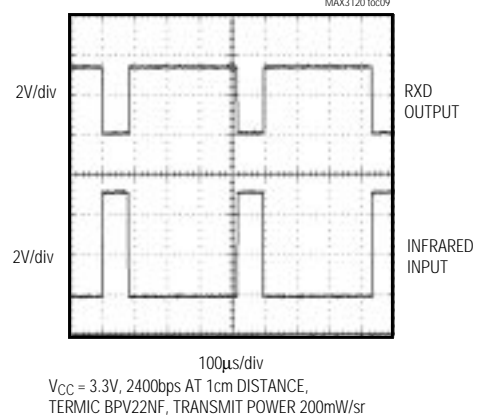

**RXD OUTPUT vs. INFRARED INPUT**

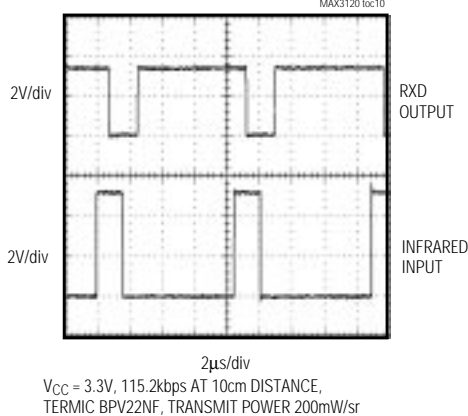

**RXD OUTPUT vs. INFRARED INPUT**

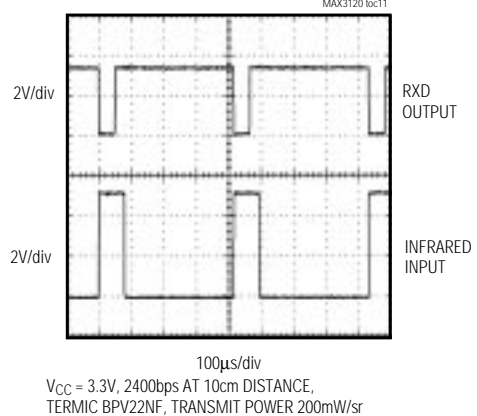

# Low-Profile, 3V, 120 $\mu$ A, IrDA Infrared Transceiver

MAX3120

## Typical Operating Characteristics (continued)

( $T_A = +25^\circ\text{C}$ , unless otherwise noted.)

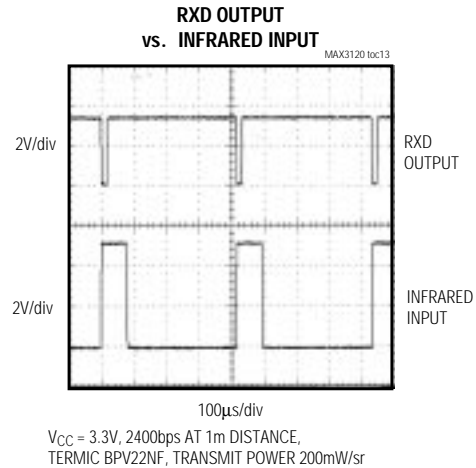
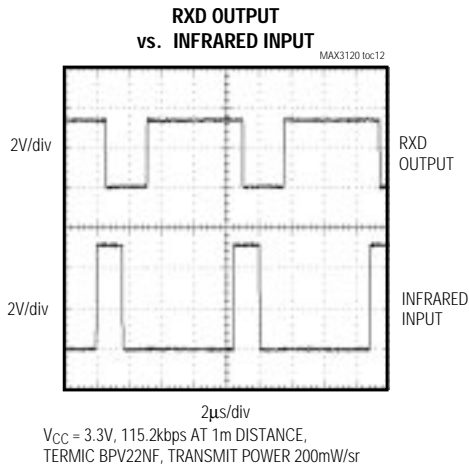

## Pin Description

PIN	NAME	FUNCTION
1	TXD	IR Transmitter TTL/CMOS Data Input. High = LED on.
2	V <sub>CC</sub>	Supply Voltage
3	GND	Ground. Connect anode of PIN diode to GND. Connect GND to PGND.
4	PINC	PIN Diode Cathode Input. Connect cathode of PIN diode to PINC.
5	SHDN	Shutdown Input. Active low.
6	PGND	Power Ground. Ground for IR LED driver. Connect PGND to GND.
7	LEDC	LED Driver Output. Connect cathode of IR-emitting LED to LEDC.
8	RXD	IR Receiver TTL/CMOS Data Output. Pulses low for IR input pulse.

## Detailed Description

The MAX3120 is an IrDA 1.2-compatible infrared (IR) transceiver. By selecting appropriate external optical components (see *IR LED and PIN Photodiode Selection* section), the MAX3120 will operate at data rates of 2.4kbps to 115kbps at distances from 1cm to 1m. Because of its low-noise design, the MAX3120 achieves a bit error rate (BER) below  $10^{-8}$  at maximum data rates when used with the appropriate external components. On-chip filtering rejects out-of-band ambient light signals that would otherwise interfere with IR communication. Also included in the MAX3120 is a high-power LED driver capable of sinking 200mA. It can drive most available IR LEDs at IrDA speeds of 2.4kbps to 115kbps.

## Receiver

The MAX3120's IR receiver amplifier reverse biases the PIN diode by approximately 1.2V, and the PIN diode converts pulses of IR light into pulses of current. The input transimpedance (current-to-voltage) amplifier then converts these current pulses into voltage pulses of a useful magnitude. The MAX3120 filters the resulting output voltage pulses to remove low-frequency ambient light interference and high-frequency circuit noise. Finally, a high-speed comparator translates these voltage pulses into usable CMOS output levels (Figure 1).

# Low-Profile, 3V, 120 $\mu$ A, IrDA Infrared Transceiver

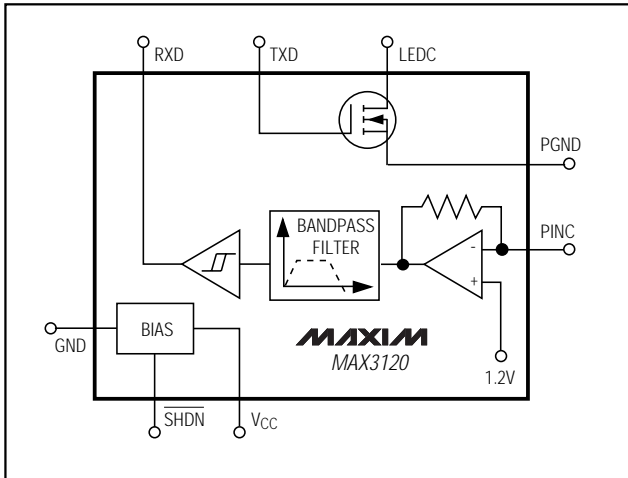

Figure 1. Functional Diagram

## Transmitter

The MAX3120's IR transmitter consists of a high-power MOS switch, capable of quickly switching 200mA with less than  $2\Omega$  of on-resistance. Internal buffering keeps the input capacitance of the TXD pin extremely low to ease the input drive requirement. Connect an IR LED in series with a current-setting resistor to select the appropriate IR output power (see the *Powering the IR LED* section). Note that the transmitter does not have an automatic shutoff circuit, so pay special attention to component power dissipation in high-duty-cycle transmit schemes.

## Applications Information

### IR LED and PIN Photodiode Selection

The IrDA specification calls for an IR transmitter with a peak wavelength between 850nm and 900nm. Within a  $\pm 15^\circ$  half-cone-angle, the output intensity of the IR LED must be between 40mW/sr and 500mW/sr. Outside a  $\pm 30^\circ$  half-cone-angle, the output intensity of the IR LED must fall below 40mW/sr. The optical rise and fall times of the IR LED must be less than 600ns. Based on these system requirements, the Hewlett Packard HSDL-4220 or the Temic TSHF5400 IR LEDs are two appropriate choices.

Appropriate PIN photodiode selection is extremely important to system performance. The PIN diode must generate at least 200nA (minimum sensitivity of the MAX3120) of current when aimed  $\pm 15^\circ$  off-axis with an incident irradiance of  $4\mu\text{W}/\text{cm}^2$ . Use the following equation to determine if the Temic BPV22NF meets these requirements:

$$I_{\text{PIN}} = (4\mu\text{W}/\text{cm}^2)(0.075\text{cm}^2)(1.8)(0.95)^2(0.6\text{A/W}) \\ = 291\text{nA}$$

The first term ( $4\mu\text{W}/\text{cm}^2$ ) is the minimum guaranteed irradiance in the  $\pm 15^\circ$  angular range. The second term ( $0.075\text{cm}^2$ ) is the effective sensitive area of the PIN diode. The factor of 1.8 accounts for the efficiency increase due to the spherical lens. The first 0.95 factor normalizes the sensitivity to the 875nm wavelength, while the second 0.95 factor adjusts for decreased receiver efficiency at  $\pm 15^\circ$  off-axis. The last term, 0.6A/W, is the sensitivity of the PIN diode. In this example, the Temic BPV22NF is an appropriate selection.

The final important factor in selecting a PIN diode is effective diode capacitance. It is important to keep this capacitance below 70pF at 1.2V reverse bias. Higher input capacitance can compromise system noise performance by increasing the noise gain of the input transimpedance amplifier.

### Powering the IR LED

Set the current in the IR LED using an external resistor. Consult the IR LED manufacturer's data sheet to select a forward current that will meet IrDA specifications discussed in the *IR LED and PIN Photodiode Selection* section. Look up the drop across the LED ( $V_{\text{LED}}$ ) and the drop across the MAX3120 LED driver (see *Typical Operating Characteristics -  $V_{\text{LEDC}}$* ) and choose the current-setting resistor based on the following equation:

$$R_{\text{SET}} = \frac{V_{\text{CC}} - V_{\text{LED}} - V_{\text{LEDC}}}{I_{\text{SET}}}$$

Using the Hewlett Packard HSDL-4220 IR LED as an example,  $V_{\text{CC}} = 5\text{V}$ ,  $I_{\text{SET}} = 100\text{mA}$ , and  $V_{\text{LED}} = 1.67\text{V}$ , therefore:

$$V_{\text{LEDC}} = 0.08\text{V}$$

$$R_{\text{SET}} = 32.5\Omega$$

# Low-Profile, 3V, 120μA, IrDA Infrared Transceiver

MAX3120

Power-dissipation requirements of the MAX3120, IR LED, and RSET must be met based on maximum duty cycle and output current requirements.

$$\text{MAX3120 Power Dissipation} = I_{\text{SET}} \cdot V_{\text{LEDC}} \cdot \text{Duty Cycle}$$

$$\text{IR LED Power Dissipation} = I_{\text{SET}} \cdot V_{\text{LED}} \cdot \text{Duty Cycle}$$

$$R_{\text{SET}} \text{ Power Dissipation} = I_{\text{SET}}^2 \cdot R_{\text{SET}} \cdot \text{Duty Cycle}$$

### Power-Supply Noise Rejection

Because of the extremely sensitive nature of photodiode amplifiers, it is important to maintain a quiet supply voltage. Use a separate analog supply voltage where possible. Place a 1μF ceramic bypass capacitor as close to the VCC pin as possible. In especially noisy systems, connect a small (10Ω) resistor in series with VCC, in addition to the normal bypass capacitor.

### Layout Considerations

The MAX3120 requires careful layout techniques to minimize parasitic signal coupling to the PINC input. Keep the lead length between the photodiode and PINC as short as possible. Be sure to keep PC board traces to the PIN diode separate from other noisy traces. To minimize coupling, run the AGND trace adjacent to the PINC trace on both sides. To prevent oscillation, avoid routing the RXD signal near the PINC signal. Connect the anode of the PIN diode, the GND pin, and the supply bypass capacitor pin in a star-ground connection. Connect PGND and GND together. Reduce the output trace length from RXD as much as possible to minimize coupling back to the input via parasitic capacitance.

### Chip Information

TRANSISTOR COUNT: 256

### Package Information

