

General Description

The MAX31875 evaluation kit (EV kit) demonstrates the MAX31875 $\pm 2^{\circ}\text{C}$ -accurate local temperature sensor with I²C/SMBus interface. The EV kit includes a graphical user interface (GUI) that provides communication over I²C with an on-board master IC.

The MAX31875 EV kit comes with the MAX31875ROTZS+ installed.

Features

- Windows® 7, Windows 8/8.1, and Windows 10 Compatible Software

Ordering Information appears at end of data sheet.

Quick Start

Required Equipment

- MAX31875 EV kit (includes Micro-USB cable)
- USB2PMB2 USB to I²C interface board
- Windows PC

Note: In the following sections, software-related items are identified by bolding. Text in **bold** refers to items directly from the EV kit software. Text in **bold and underlined** refers to items from the Windows operating system.

Procedure

The EV kit is fully assembled and tested. Follow the steps below to verify board operation:

- 1) Visit <http://www.maximintegrated.com/en/design/tools/applications/evkit-software/> to download the latest version of the EV kit software, MAX31875EVKitSetupV1.0.zip. Save the EV kit software to a temporary folder and uncompress the ZIP file.
- 2) Connect the MAX31875PMB1 board to the USB-2PMB2 board.
- 3) Connect the USB cable from the PC to the USB-2PMB2 board. Windows may require some time to install its device driver.
- 4) Open the EV kit GUI, MAX31875EVKit.exe and select **Device**→**MAX31875PMB** option (or **MAX31875PMB**).
- 5) Click the **Scan Adapters** button, then click the **Connect** button. See [Figure 1](#).
- 6) Click the **Sample Continuously** button to begin plotting temperature data.

Windows is a registered trademark and registered service mark of Microsoft Corporation.

General Description of Software

The main window of the MAX31875 EV kit software contains controls to evaluate the MAX31875 temperature sensor.

USB2PMB Adapter

The controls within the **USB2PMB** <https://datasheets.maximintegrated.com/en/ds/USB2PMB2.pdf> Adapter groupbox allow the user to select the appropriate USB2PMB devices. When **Scan Adapters** button is pressed, it updates the drop-down list with all USB2PMB devices. With the EV kit connected to the PC, either **PMOD031875** or a similar serial number appears within the drop-down list. Make the appropriate selection respective of the IC and press the **Connect** button.

The **Attached Device Search** scans the I2C bus for supported devices. The software GUI supports all eight varieties of the MAX31875, which differ only in the I2C slave device address.

Along the right side of the window, there are drop-down boxes for each of the fields of the configuration register. Additionally, the raw register values can be read and written by the **Temperature**, **Configuration**, **THyst**, and **TOS** controls in the upper right corner of the window.

Sample rate is determined by the **0x006 Conversion Rate[1:0]** drop-down box. Click **Sample Continuously** to read temperature register and plot on graph at the configured sample rate.

The **One-Shot Read** button triggers a single temperature reading. The MAX31875 must be in Shutdown mode to enable One-Shot Read.

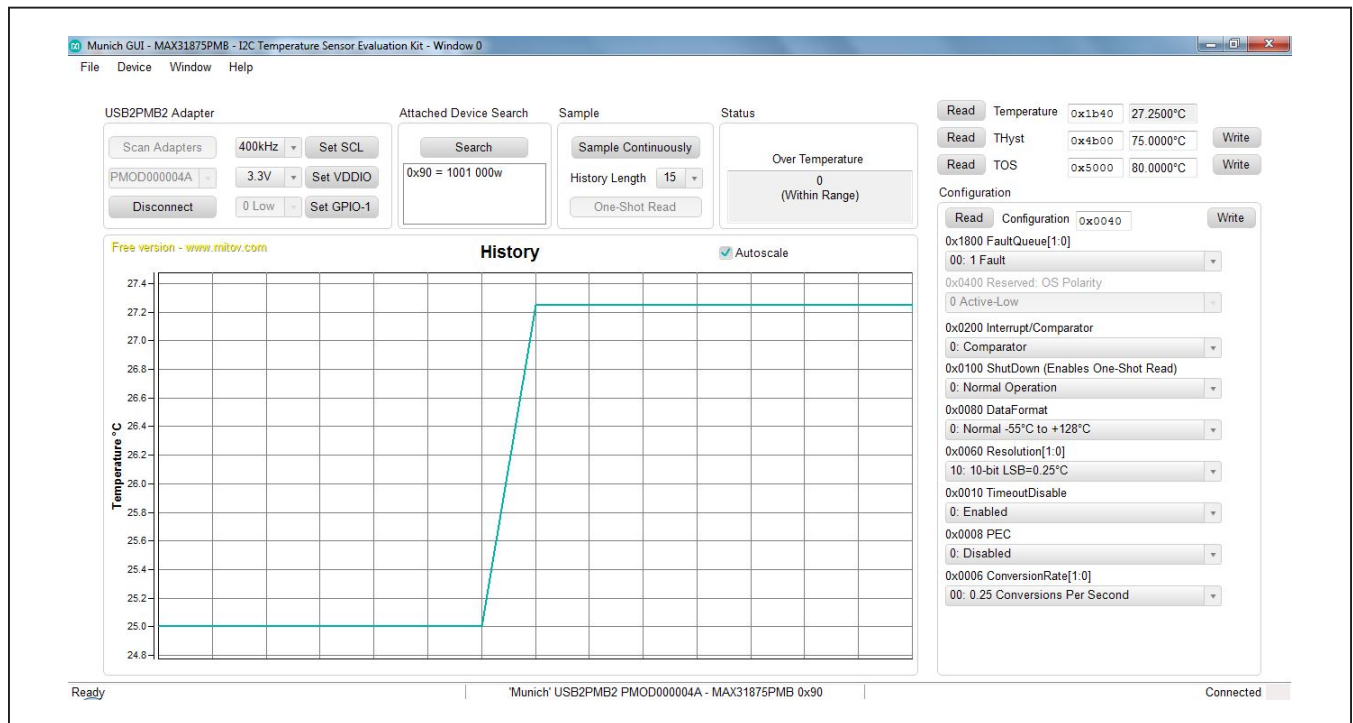

Figure 1. MAX31875 EV Kit Main Window

General Description of Hardware

The MAX31875 EV kit demonstrates the MAX31875 $\pm 2^{\circ}\text{C}$ -accurate local temperature sensor with I²C/SMBus interface. The EV kit includes the USB2PMB2 master for all I²C and I/O communication.

Extension Cable

If using a 6-pin extension cable between the USB2PMB2 and MAX31875PMB1 board, only the top row (pins 1–6) need to be connected.

Ordering Information

PART	TYPE
MAX31875EVKIT#	EV Kit

#Denotes RoHS compliant.

MAX31875 EV Kit Bill of Materials

ITEM	REF_DES	DNI/DNP	QTY	MFG PART #	MANUFACTURER	VALUE	DESCRIPTION	COMMENTS
1	C1		1	C1608X8R1E104K080AA	TDK	0.1UF	CAPACITOR; SMT (0603); CERAMIC CHIP; 0.1UF; 25V; TOL=10%; TG=-55 DEGC TO +150 DEGC; TC=X8R	
2	J1		1	PEC06SAAN	SULLINS ELECTRONICS CORP.	PEC06SAAN	CONNECTOR; MALE; THROUGH HOLE; BREAKAWAY; STRAIGHT; 6PINS	
3	JU4		1	TSW-106-08-S-D-RA	SAMTEC	TSW-106-08-S-D-RA	CONNECTOR; THROUGH HOLE; DOUBLE ROW; RIGHT ANGLE; 12PINS;	
4	U1		1	MAX31875	MAXIM	MAX31875	EVKIT PART-IC; MAX31875; PACKAGE OUTLINE: 21-100151A; PACKAGE CODE: Z40A0+1; WLP4;	
5	J2	DNI	1	PEC06SABN	SULLINS ELECTRONICS CORP.	PEC06SABN	CONNECTOR; MALE; THROUGH HOLE; BREAKAWAY; STRAIGHT; 6PINS; HEAD=0.230IN; TAIL=0.230IN	
6	PCB	-	1	MAX31875PMB	MAXIM	PCB	PCB Board:MAX31875PMB1 EVALUATION KIT	
TOTAL			6					

MAX31875 EV Kit Schematic

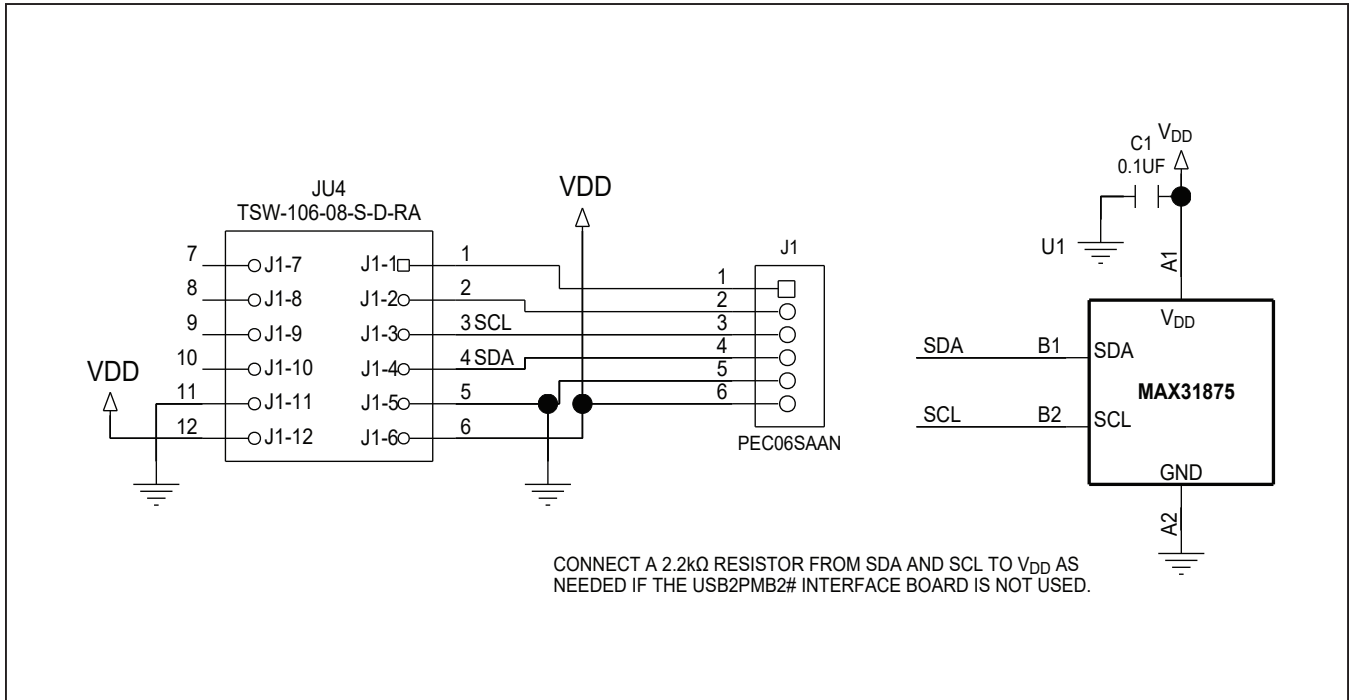

MAX31875 EV Kit PCB Layout Diagrams

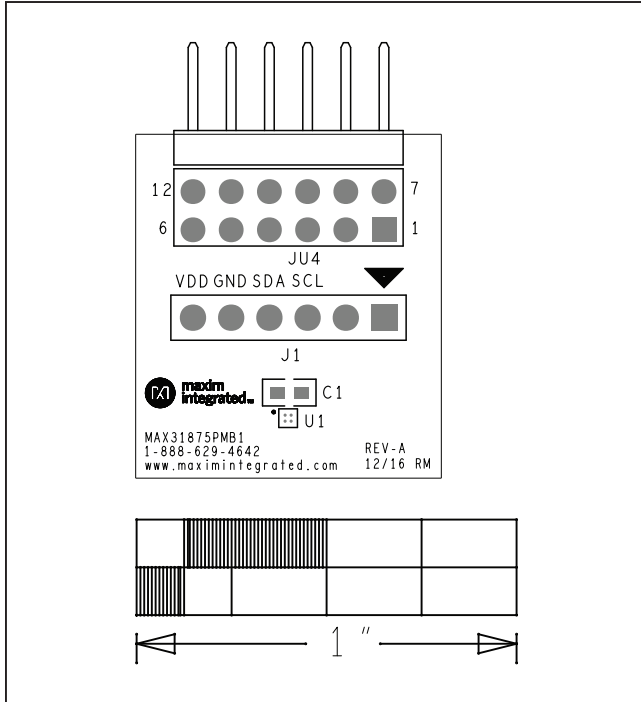

MAX31875 EV Kit—Top Silkscreen

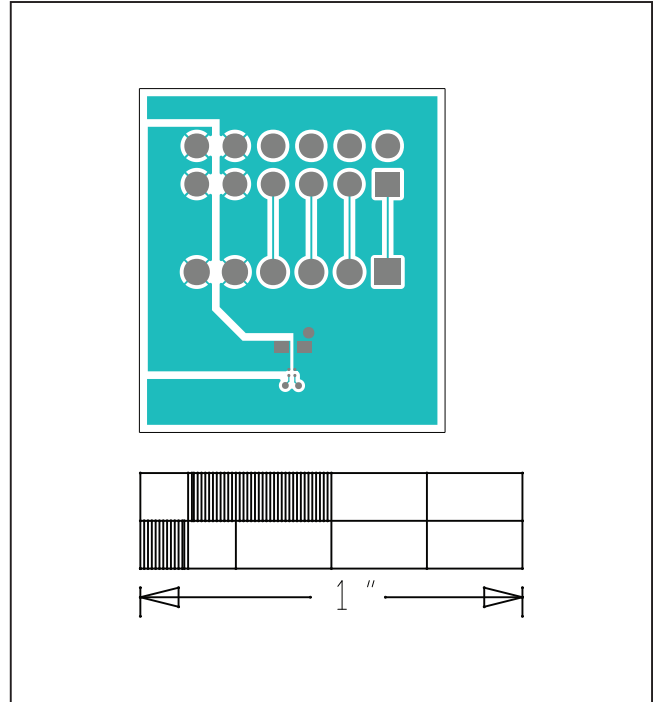

MAX31875 EV Kit—Top

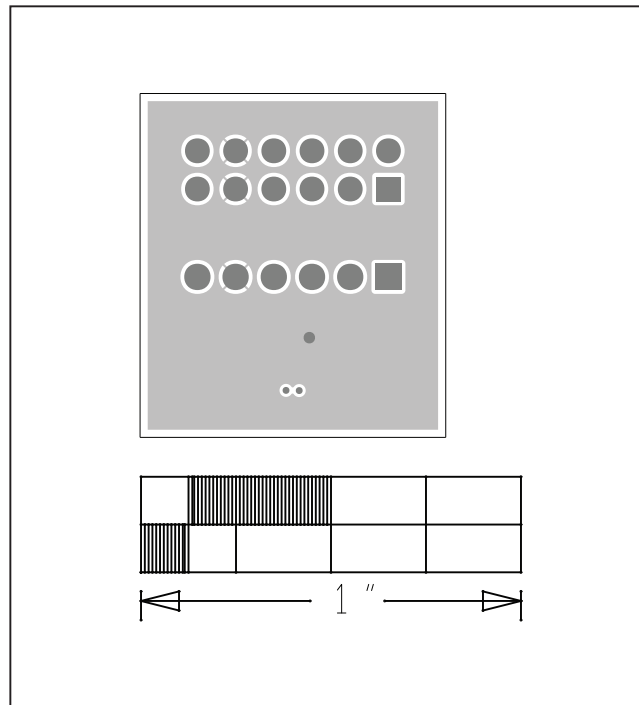

MAX31875 EV Kit—Layer 2

MAX31875 EV Kit PCB Layout Diagrams (continued)

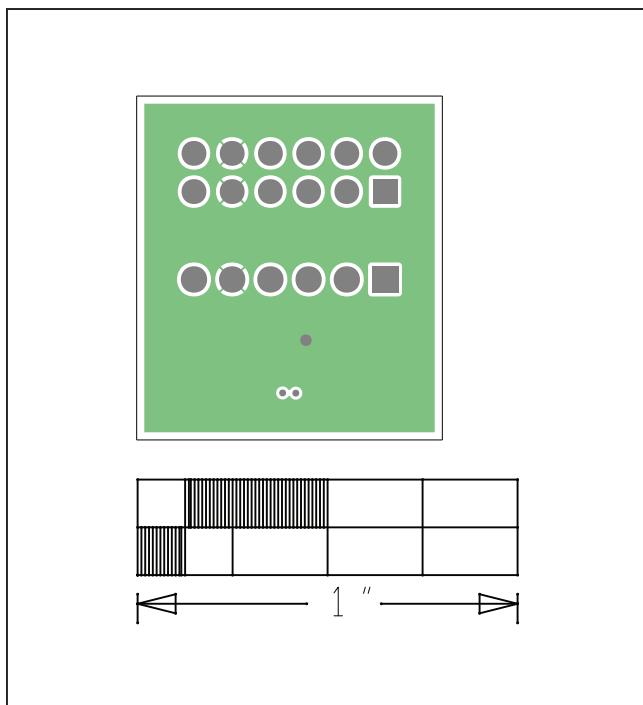

MAX31875 EV Kit—Layer 3

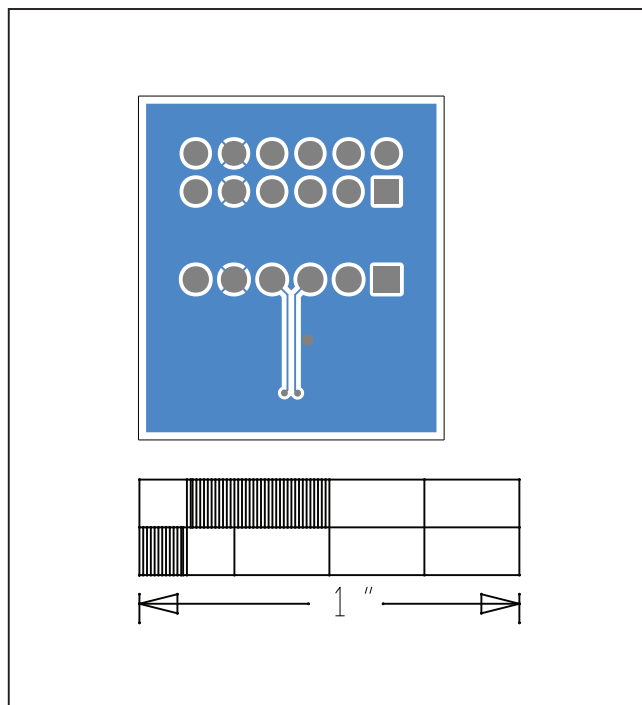

MAX31875 EV Kit—Bottom