

General Description

The MAX34407 evaluation kit (EV kit) provides the hardware and software graphical user interface (GUI) necessary to evaluate the MAX34407 SMBus 4-Channel Wide Dynamic Range Power Accumulator. The EV kit includes a MAX34407EWE+ installed, as well as a micro-USB cable to communicate with a PC.

EV Kit Contents

- Assembled circuit board including MAX34407EWE+
- Micro-USB cable

Features

- Easy Evaluation of the MAX34407
- USB HID interface
- Windows XP® and Windows® 7-Compatible Software
- RoHS Compliant
- Proven PCB Layout
- Fully Assembled and Tested

Ordering Information appears at end of data sheet.

EV Kit Photo



Windows is a registered trademark and registered service mark of Microsoft Corporation.

Windows XP is a registered trademark and registered service mark of Microsoft Corporation.

MAX34407 EV Kit Files

FILE	DESCRIPTION
MAX34407EVKSoftwareInstall.EXE	Application program

Note: The .EXE file is downloaded as a .ZIP file.

Quick Start

Required Equipment

- MAX34407 EV kit
- Windows XP or Windows 7 PC
- USB port
- Micro-USB cable (included)
- EV kit hardware (included)
- Screwdriver
- Load (to measure power)

Note: In the following sections, software-related items are identified in **bold**. Text in bold refers to items directly from the install or EV kit software. Text in **bold and underlined** refers to items from the Windows operating system.

Procedure

The EV kit is fully assembled and tested. Follow the steps below to verify board operation:

- 1) Ensure that all four jumpers on J3/J22 are populated.
- 2) Place the EV kit hardware on a nonconductive surface to ensure that nothing on the PCB gets shorted to the workspace.
- 3) Prior to starting the GUI, connect the EV kit hardware to a PC using the supplied micro-USB cable or equivalent. The POWER LED (D20) should be green and the COM LED (D21) should be red and slowly flash orange.
- 4) Windows should automatically begin installing the necessary device driver. The USB interface of the EV kit hardware is configured as an HID device and therefore does not require a unique/custom device driver. Once the driver installation is complete, a Windows message appears near the **System Icon** menu, indicating that the hardware is ready to use. Do not attempt to run the GUI prior to this message. If you do, then you must close the application and restart it once the driver installation is complete. On some versions of Windows, administrator privileges may be required to install the USB device driver.

- 5) Once the device driver installation is complete, visit www.maximintegrated.com/evkitsoftware to download the latest version of the EV kit software, *MAX34407EVKitSetupV0.4.zip*. Save the EV kit software to a temporary folder.
- 6) Open the .ZIP file and double-click on the .EXE file to run the installer. A message box stating **The publisher could not be verified. Are you sure you want to run this software?** may appear. If so, click **Yes**.
- 7) The installer GUI appears. Click **Next** and then **Install**. Once complete click **Close**.
- 8) Go to **Start | All Programs**. Look for the **MAX34407EVKitSoftware** folder and click on **MAX34407EVKitSoftware.EXE** inside the folder.
- 9) When the GUI appears, the text at the bottom-right corner of the window should display **EV Kit Hardware Connected**. The COM LED (D21) changes to green.
- 10) Connect a load to at least one of the power monitors (IN1–IN4) and then click **Single Read**.

Detailed Description of Software

Software Startup

If the MAX34407 EV kit is connected when the software is opened, the software first initializes the hardware to communicate. Next, the software searches for all slave addresses on the I²C bus and connects to the first valid slave address. Then, the GUI displays **EV Kit Hardware Connected** at the bottom-right corner of the window under the Maxim logo. If the EV kit is not connected on software startup, the GUI populates with default EV kit values and displays **EV Kit not detected!** Once the EV kit is connected, the GUI searches for slave addresses.

Menu Items

The **Device** menu item allows the user to connect to a desired device. **Find Slave Addresses** searches for all slave addresses connected to the I²C bus. To select a device, click **Select Slave Address** and all the slave addresses found are shown and are selectable.

Status Log

The status log below the tabs displays all the actions the GUI performs. Whenever a SMBus command is read or written, the action is confirmed by the log. The log can be cleared by clicking on the **Clear Log** button.

Monitor/Graph Tab

The **Monitor/Graph** tab sheet (Figure 1) displays all the accumulator values. In the **Monitor** group box table, the **Polled** values are the Accumulator values read from PWR_ACC_1 to PWR_ACC_4 (03h to 06h) that are converted to amps using the **RSENSE** value in the **Control** table shown in Figure 2. The **Sampled Voltage** and **Average Power** columns track the voltage and average power of the **Polled** value for each channel. All values on the tab are read when the tab is selected or when the **Read** button is clicked. The **OC** status bits are cleared after every read. Check the **Auto Poll** checkbox to continuously read every 0.3s.

The **Data Log Controls** group box contains the graph-related controls. **Graph Points** displays the number of reads that have been tracked in the data log. The

Sampled Voltage and **Average Power** values are still based on all the poll count values, to reset the **Poll Count**, **Sampled Voltage**, and **Average Power** values, click on the **Data Log Reset** button. To save all the data graphed to a CSV file, click on the **Save Data** button. The **Average Power/Voltage** button selects the Average Power or voltage to be graphed.

Control/Registers Tab

The **Control/Registers** tab sheet (Figure 2) displays all the SMBus commands and their current values. In the **Control** group box table, the **RSENSE (mΩ)** column is the value of the resistor (R3X–R4X) between IN+ and IN- signals. The **Max Current (A)** column displays the maximum current threshold converted to amps using the **RSENSE** value.

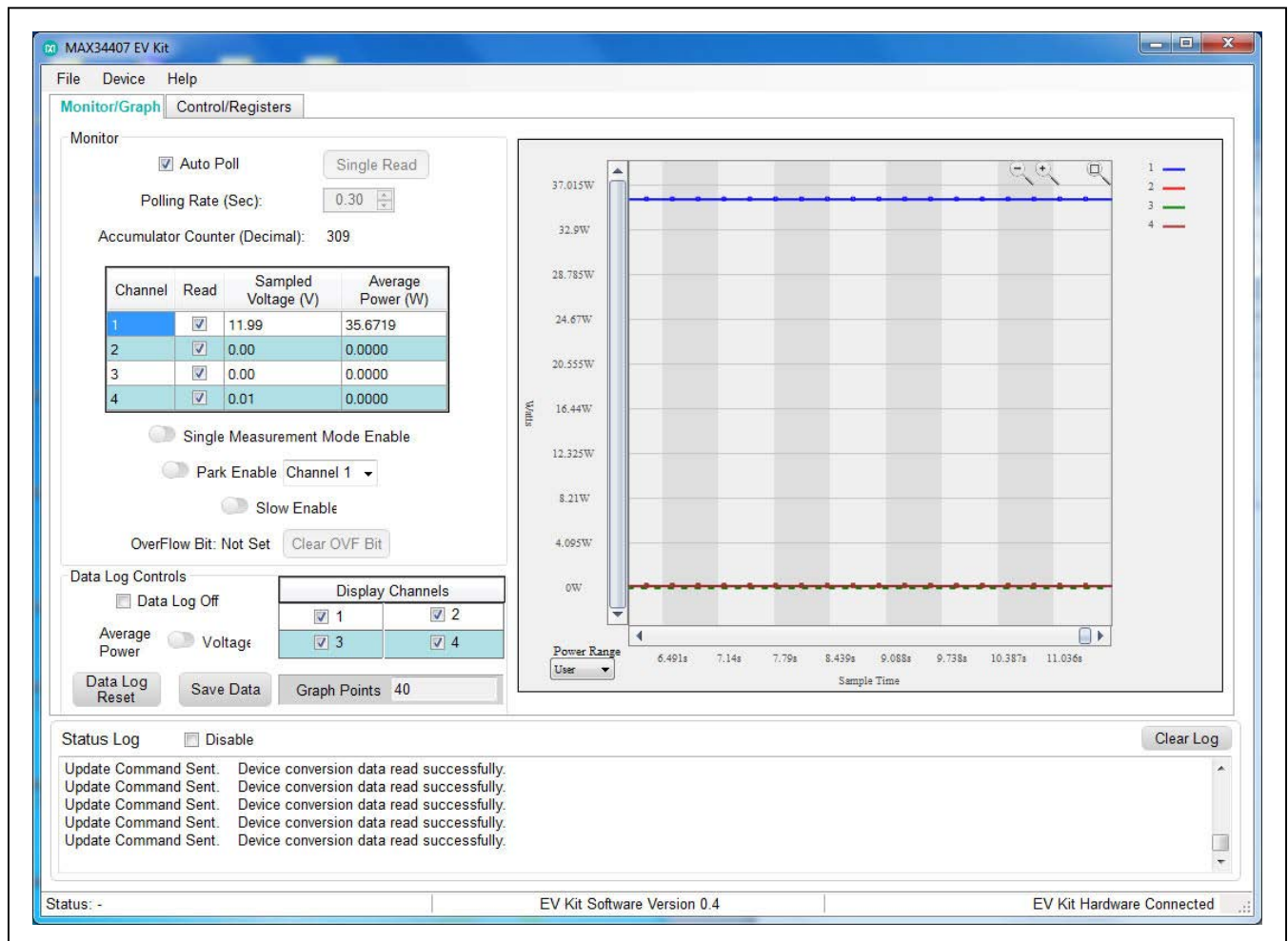

Figure 1. MAX34407 EV Kit GUI (Monitor/Graph Tab)

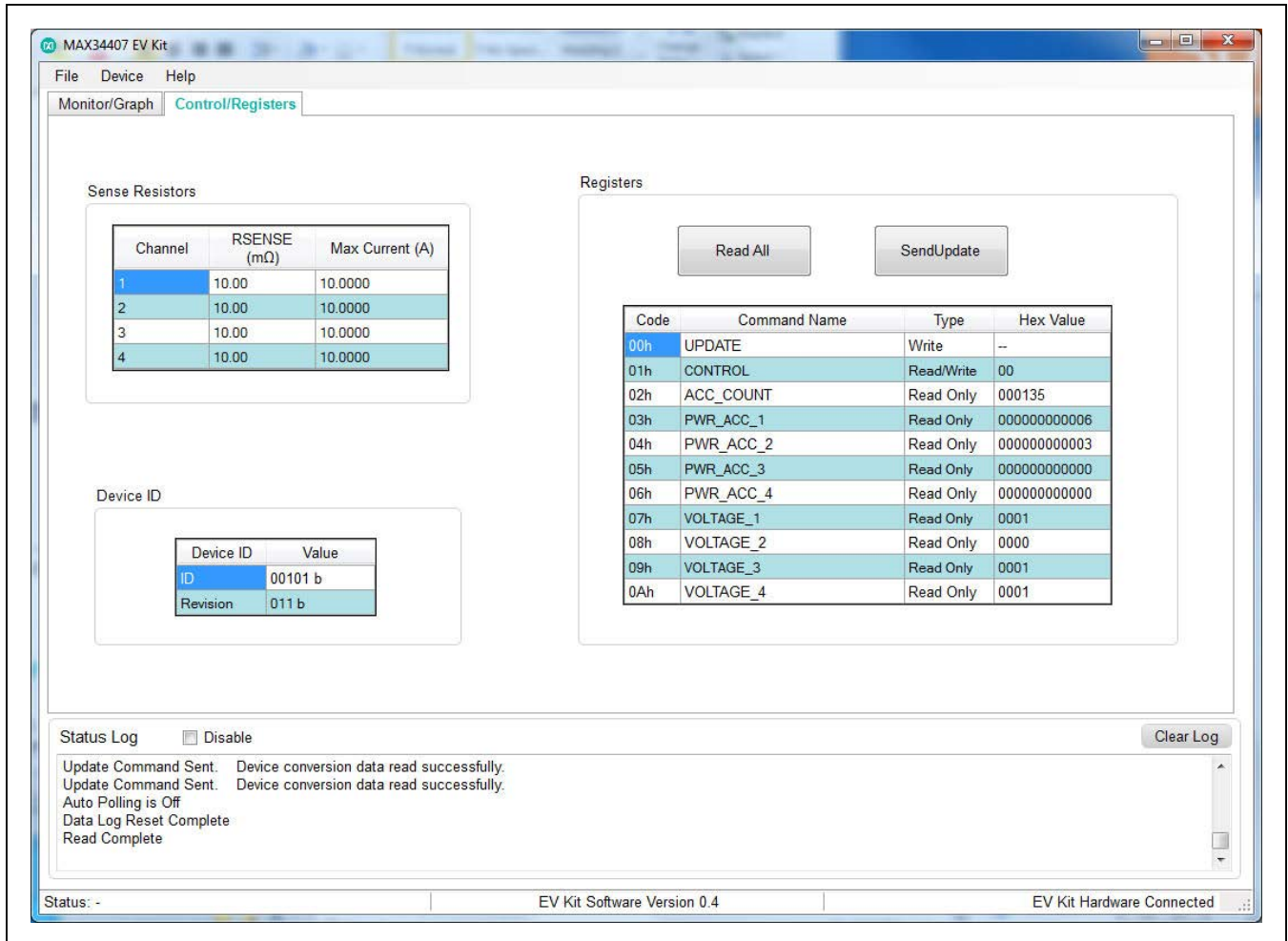

Figure 2. MAX34407 Control/Registers Tab

Detailed Description

The MAX34407 automatically sequences through the channels to collect samples from the common-mode voltage and the current-sense amplifiers. The 16-bit current value and the 12-bit voltage value are then multiplied to create a 28-bit power value that is then written to the power accumulator.

Troubleshooting

All efforts were made to ensure that each EV kit works on the first try, right out-of-the-box. In the rare occasion that a problem is suspected, see [Table 3](#) to help troubleshoot the issue.

Table 1. Description of Switches (SLOW & PDN)

SWITCH	POSITION	DESCRIPTION
SLOW	VIO	Slow Mode for Reduced Power Consumption.
	GND	Fast Mode.
PDN (Power Down)	VIO	GUI reading device.
	GND	GUI stops reading device.

Table 2. Description of LEDs (D20, D21)

LED	COLOR	DESCRIPTION
D20 (POWER)	Red	USB Power Fault: A fault occurred due to overvoltage limit, current limit, or thermal limit.
	Green	USB Power: USB power supply is on.
D21 (COM)	Red	Communication: After the software has initialized the hardware, the LED flashes red when a command from the PC is received.
	Green	Initialized: Hardware has been initialized by software.

Table 3. Troubleshooting

SYMPTOM	CHECK	SOLUTION
GUI indicates: Hardware not found	Is the LED labeled D20 red?	If yes, then the electronic fuse is in a fault state. Inspect for electrical shorts on the PCB and make sure that the PCB is not sitting on a conductive surface.
	Does the LED labeled D21 turn green when the GUI is running?	If not, then exit the GUI and try running it again. If D21 still does not turn green, then exit the GUI and try connecting the USB cable to a different USB port on the PC and wait for a Windows message indicating that the hardware is ready to use. Run the GUI again.
	Are any of the LEDs illuminated?	If not, then the PCB may not be getting power from the USB. Try a different USB cable or a different USB port.
GUI indicates Read Failed! and all slave addresses are being found	J23/22	Make sure all four jumpers on J3/J22 are populated.

Component Information, PCB Layout, and Schematics

See the following links for component information, PCB layout diagrams, and schematics.

- [MAX34407 EV BOM](#)
- [MAX34407 EV PCB](#)
- [MAX34407 EV Schematics](#)

Ordering Information

PART	TYPE
MAX34407EVKIT#	EV Kit

#Denotes an RoHS-compliant device that may include lead(Pb), which is exempt under the RoHS requirements.

Revision History

REVISION NUMBER	REVISION DATE	DESCRIPTION	PAGES CHANGED
0	6/16	Initial release	—
1	9/16	Removed <i>Monitor Current of Load</i> section and <i>Figure 3</i>	5

For pricing, delivery, and ordering information, please contact Maxim Direct at 1-888-629-4642, or visit Maxim Integrated's website at www.maximintegrated.com.

Maxim Integrated cannot assume responsibility for use of any circuitry other than circuitry entirely embodied in a Maxim Integrated product. No circuit patent licenses are implied. Maxim Integrated reserves the right to change the circuitry and specifications without notice at any time.

EVKIT Part Number: MAX34407EVKIT#

Revision: C

Date Last Edited: 01-12-16

Last Edited by: Amir Mirbagheri

Item	Ref Designator	Qty	Value	Description	LibRef	Manufacturer	Manufacturer_Part_Number	Blank Internal Part Number	Programmed Internal Part Number
1	B1	1	GND	BANANA JACK	BANANA JACK	Deltron	571-0100		
2	C1, C3, C212	3	0.1μF	0805 Capacitor	CAP	TDK Corporation	CGA4J2X7R2A104K		
3	C1A, C1B, C1C, C1D, C2, C2A, C2B, C2C, C2D, C4, C5, C6, C215	13	DNP	0805 Capacitor	CAP				
4	C201, C202, C204	3	10μF	0805 Capacitor	CAP	Taiyo Yuden	EMK212ABJ106KD-T		
5	C203, C214	2	0.01μF	0805 Capacitor	CAP	Murata	GRM21BR72A103K		
6	C211	1	1μF	0805 Capacitor	CAP	TDK Corporation	C2012X7R1H105K/SOFT		
7	C213	1	220nF	0805 Capacitor	CAP	TDK Corporation	C2012X7R1H224K		
8	D20	1	LED_DUAL	LED_BI-COLOR	LED_DUAL	Knightbright	APHBM2012SURKCGKC		
9	D21	1	COM	LED_BI-COLOR	LED_DUAL	Knightbright	APHBM2012SURKCGKC		
10	D22	1	SCHOTTKEY	MINI2-F1	SCHOTTKEY	Panasonic - SSG	DB2W31900L		
11	J1A, J1B, J1C, J1D	4	CON2	32A_2T_PCB 2-position screw terminals 6.35mm pitch	CON2	Phoenix Contact	1714955		
12	J3	1	Dongle Header	HDR_4pin	CON4	3M Headers & Wire Housing	961104-6804-AR		
13	J20	1	USB_5PIN	USB_MICRO-B	USB_5PIN	Molex	105017-0001		
14	J21	1	DNP	HDR_2PIN	CON2				
15	J22	1	I2C DONGLE	HDR_4pin	CON4	3M Headers & Wire Housing	961104-6804-AR		
16	R1, R1A, R1B, R1C, R1D, R2, R2A, R2B, R2C, R2D, R5, R6, R7, R201, R202, R214	16	0Ω	0805 Resistor	RES1	Vishay/Dale	CRCW08050000Z0EA		
17	R3, R4, R213	3	2.2kΩ	0805 Resistor	RES1	Vishay/Dale	CRCW08052K20FKEA		
18	R3A, R3B, R3C, R3D	4	10mΩ	2512 Resistor	RES1	Panasonic Electronic Components	ERJ-M1WSF10MU		
19	R4A, R4B, R4C, R4D	4	DNP	2512 Resistor	RES1				
20	R203, R205	2	560Ω	0805 Resistor	RES1	Vishay/Dale	CRCW0805560RFKEA		
21	R204	1	100kΩ	0805 Resistor	RES1	Vishay/Dale	CRCW0805100KFKEA		
22	R206	1	45.3kΩ	0805 Resistor	RES1	Vishay/Dale	CRCW080545K3FKEA		
23	R207	1	10kΩ	0805 Resistor	RES1	Vishay/Dale	CRCW080510K0FKEA		
24	R210	1	4.7kΩ	0805 Resistor	RES1	Vishay/Dale	CRCW08054K70FKEA		
25	R211, R212	2	330Ω	0805 Resistor	RES1	KOA Speer	RK73H2ATTD3300F		
26	R215, R216	2	DNP	0805 Resistor	RES1				

27	S1, S2	2	SW-SPDT	SPDT_Slider	SW-SPDT	TE Connectivity / Alcoswitch	SLS121PC04		
28	TP1A	1	IN1+	TEST POINT - White	TEST_POINT	Keystone	5012		
29	TP1B	1	IN2+	TEST POINT - White	TEST_POINT	Keystone	5012		
30	TP1C	1	IN3+	TEST POINT - White	TEST_POINT	Keystone	5012		
31	TP1D	1	IN4+	TEST POINT - White	TEST_POINT	Keystone	5012		
32	TP2A	1	IN1-	TEST POINT - White	TEST_POINT	Keystone	5012		
33	TP2B	1	IN2-	TEST POINT - White	TEST_POINT	Keystone	5012		
34	TP2C	1	IN3-	TEST POINT - White	TEST_POINT	Keystone	5012		
35	TP2D	1	IN4-	TEST POINT - White	TEST_POINT	Keystone	5012		
36	TP3A	1	IN1_P	TEST POINT - White	TEST_POINT	Keystone	5012		
37	TP3B	1	IN2_P	TEST POINT - White	TEST_POINT	Keystone	5012		
38	TP3C	1	IN3_P	TEST POINT - White	TEST_POINT	Keystone	5012		
39	TP3D	1	IN4_P	TEST POINT - White	TEST_POINT	Keystone	5012		
40	TP4A	1	IN1_N	TEST POINT - White	TEST_POINT	Keystone	5012		
41	TP4B	1	IN2_N	TEST POINT - White	TEST_POINT	Keystone	5012		
42	TP4C	1	IN3_N	TEST POINT - White	TEST_POINT	Keystone	5012		
43	TP4D	1	IN4_N	TEST POINT - White	TEST_POINT	Keystone	5012		
44	TP7	1	5V	TEST POINT - Red	TEST_POINT	Keystone	5010		
45	TP8, TP16	2	3.3V	TEST POINT - Red	TEST_POINT	Keystone	5010		
46	TP10	1	SDA	TEST POINT - White	TEST_POINT	Keystone	5012		
47	TP11	1	SCL	TEST POINT - White	TEST_POINT	Keystone	5012		
48	TP12	1	VIO	TEST POINT - Red	TEST_POINT	Keystone	5010		
49	TP13	1	ADDR	TEST POINT - White	TEST_POINT	Keystone	5012		
50	TP14	1	SLOW	TEST POINT - White	TEST_POINT	Keystone	5012		

51	TP15	1	PDN	TEST POINT - White	TEST_POINT	Keystone	5012		
52	TP17, TP18, TP19	3	GND	TEST POINT - Black	TEST_POINT	Keystone	5011		
53	U1A	1	MAX34407	WLP16C50P4X4_219 X228X64	MAX34407	Maxim Integrated	MAX34407EWE+		
54	U1B (DNP)	1	DNP	SM19-TSSOP-16_173	SM19-TSSOP				
55	U20 Should be programmed	1	PIC18LF2550	SOIC127P1030X265- 28N IC+,PRGM,89- 3900H#K02,U20	PICfor DS3900	Microchip	PIC18LF2550-I/SO	EQ1270	EICP3900HU1
56	U21	1	MAX4995A	SOT23-6	MAX4995A	Maxim Integrated	MAX4995AAUT+		
57	U22	1	MAX8902B	QFN127P600-8NEP	MAX8902B	Maxim Integrated	MAX8902BATA+		
58	X1	1	KC3225A48.000 0C30E00	CRYSTAL_SM_3.2X2.5 mm_A	OSC_CMOS_4 pin	AVX	KC3225A48.0000C30E00		
59	Micro USB Cable shoud be included in the EVMKit Box	1		A Male to Micro USB B Male Cable		Tripp Lite	UR050-006		

3750.00

1000.00

3750.00

MAX34407

Precision Quad
Power Accumulator
Evaluation Kit

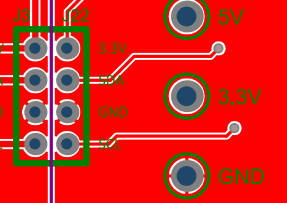
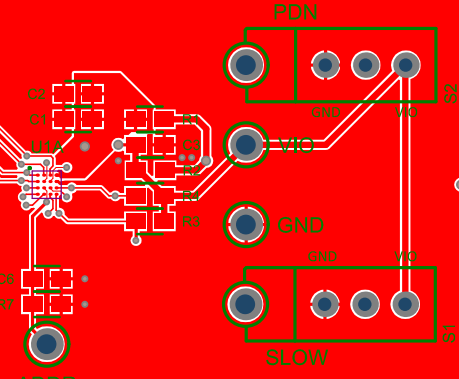
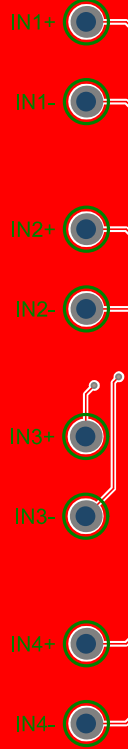
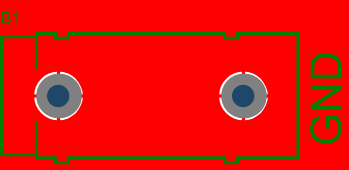
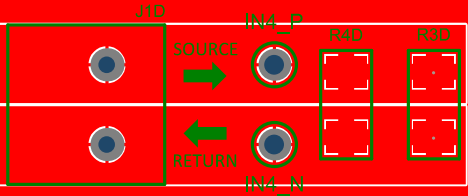
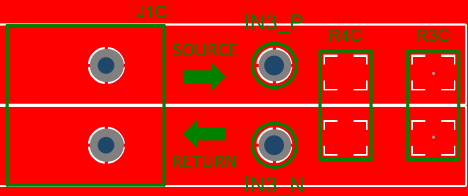
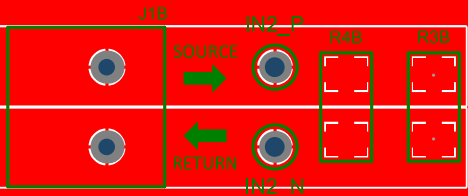
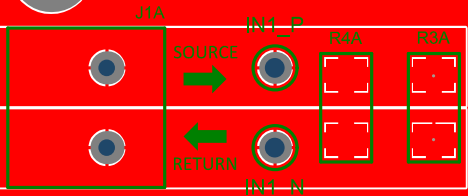

maxim
integrated™

